

Lang

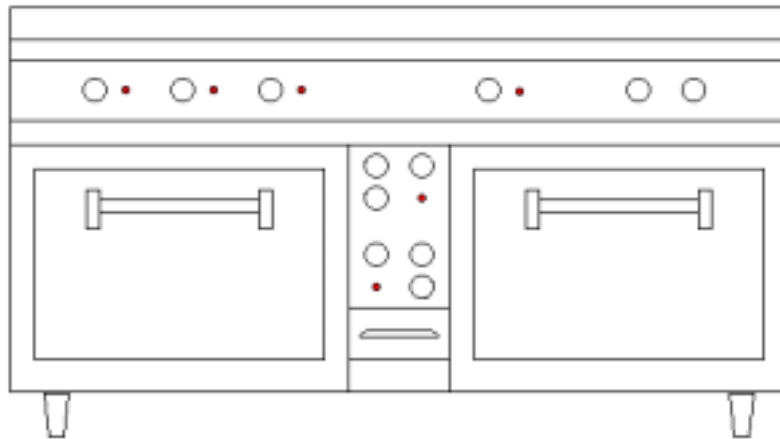

Service Manual for the Lang Models:

500S-A, 500S-B, 500S-C, 500S-D,

500S-E, 500S-F, 500S-G

TABLE OF CONTENTS

| <u>CHAPTER</u> | <u>PAGE</u> |
|--------------------------------|--------------------|
| 1. TABLE OF CONTENTS | 1 |
| 2. READ FIRST | 2 |
| 3. EQUIPMENT DESCRIPTION | 4 |
| 4. INSTALLATION..... | 5 |
| 5. START-UP | 6 |
| 6. GENERAL OPERATION..... | 7 |
| 7. SEQUENCE OF OPERATION | 9 |
| 8. TROUBLESHOOTING | 10 |
| 9. TECHNICAL DATA | 12 |
| 10. WIRING DIAGRAMS..... | 14 |
| 11. PARTS LIST..... | 17 |

CAUTION: EACH UNIT WEIGHS 900 LBS. FOR SAFE HANDLING, INSTALLER SHOULD OBTAIN HELP AS NEEDED, OR EMPLOY APPROPRIATE MATERIALS HANDLING EQUIPMENT (SUCH AS A FORKLIFT, DOLLY, OR PALLET JACK) TO REMOVE THE UNIT FROM THE SKID AND MOVE IT TO THE PLACE OF INSTALLATION.



CAUTION: ANY STAND, COUNTER OR OTHER DEVICE ON WHICH RANGE WILL BE LOCATED MUST BE DESIGNED TO SUPPORT THE WEIGHT OF THE RANGE.



CAUTION: SHIPPING STRAPS ARE UNDER TENSION AND CAN SNAP BACK WHEN CUT.



DANGER: THIS APPLIANCE MUST BE GROUNDED AT THE TERMINAL PROVIDED. FAILURE TO GROUND THE APPLIANCE COULD RESULT IN ELECTROCUTION AND DEATH.



WARNING: INSTALLATION OF THE UNIT MUST BE DONE BY PERSONNEL QUALIFIED TO WORK WITH ELECTRICITY. IMPROPER INSTALLATION CAN CAUSE INJURY TO PERSONNEL AND/OR DAMAGE TO EQUIPMENT. UNIT MUST BE INSTALLED IN ACCORDANCE WITH ALL APPLICABLE CODES.



NOTICE: The data plate is located right of range top controls and behind circuit breaker door on oven. The range voltage, wattage, serial number, wire size, and clearance specifications are on the data plate. This information should be carefully read and understood before proceeding with the installation.



NOTICE: The installation of any components such as a vent hood, grease extractors, fire extinguisher systems, must conform to their applicable National, State and locally recognized installation standards.



NOTICE: During the first few hours of operation you may notice a small amount of smoke coming off the range, or out of the oven, and a faint odor from the smoke. This is normal for a new range and will disappear after the first few hours of use.



CAUTION: ALWAYS KEEP THE AREA NEAR THE APPLIANCE FREE FROM COMBUSTIBLE MATERIALS.



CAUTION: KEEP FLOOR IN FRONT OF EQUIPMENT CLEAN AND DRY. IF SPILLS OCCUR, CLEAN IMMEDIATELY, TO AVOID THE DANGER OF SLIPS OR FALLS.



WARNING: KEEP WATER AND SOLUTIONS OUT OF CONTROLS. NEVER SPRAY OR HOSE CONTROL CONSOLE, ELECTRICAL CONNECTIONS, ETC.



CAUTION: MOST CLEANERS ARE HARMFUL TO THE SKIN, EYES, MUCOUS MEMBRANES AND CLOTHING. PRECAUTIONS SHOULD BE TAKEN TO WEAR RUBBER GLOVES, GOGGLES OR FACE SHIELD AND PROTECTIVE CLOTHING. CAREFULLY READ THE WARNING AND FOLLOW THE DIRECTIONS ON THE LABEL OF THE CLEANER TO BE USED.



NOTICE: Service on this, or any other, LANG appliance must be performed by qualified personnel only. Consult your authorized service station directory or call the factory at 1-800-224-LANG (5264), or WWW.LANGWORLD.COM for the service station nearest you.



WARNING: BOTH HIGH AND LOW VOLTAGES ARE PRESENT INSIDE THIS APPLIANCE WHEN THE UNIT IS PLUGGED/WIRED INTO A LIVE RECEPTACLE. BEFORE REPLACING ANY PARTS, DISCONNECT THE UNIT FROM THE ELECTRIC POWER SUPPLY.



CAUTION: USE OF ANY REPLACEMENT PARTS OTHER THAN THOSE SUPPLIED BY LANG OR THEIR AUTHORIZED DISTRIBUTORS CAN CAUSE BODILY INJURY TO THE OPERATOR AND DAMAGE TO THE EQUIPMENT AND WILL VOID ALL WARRANTIES.



EQUIPMENT DESCRIPTION

ELECTRIC RANGE

EXTERIOR

- The Range dimensions are 30" (76.2cm) High, 35" (89.0cm) Deep, and 60" (152.5cm) Wide.
- The Sides, Bottom, and Rear wall are constructed stainless steel.
- The Range surface can come in 7 different configurations.

CONTROLS

The 500 Series Rang is available with various controls depending upon model number. Shown below is a layout of each top configuration with its proper model number and a brief description of the controls. All 500S Ranges have two or the same type of standard bake oven, which has two 3-heat switches, one to control the top element and one to control the bottom element. In addition, the oven has a thermostat that controls the overall temperature of the oven.

500S-A

Five 12"x24" Hot tops controlled by five 850° Thermostats.

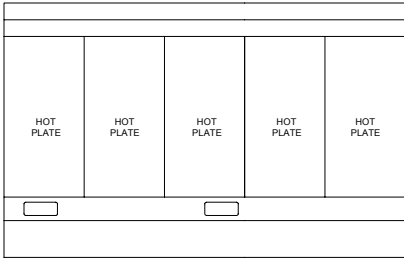

500S-B

Four 12"x24" Hot tops controlled by four 850° thermostats and two French plates controlled by two 6-heat switches.

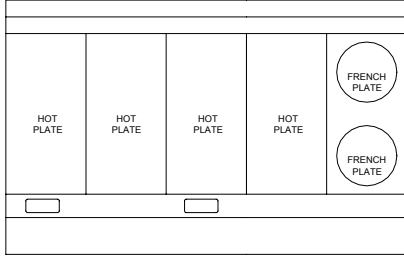

500S-C

24"x24" Griddle controlled by two 450° thermostats, two Hot tops controlled by two 850° thermostats, and two French plates controlled by two 6-heat switches.

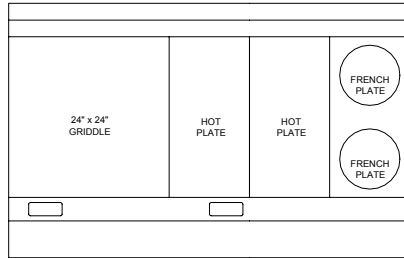

500S-D

36"x24" Griddle controlled by three 450° thermostats, 12"x24" Hot top controlled by one 850° thermostat and two French plates controlled by two 6-heat switches.

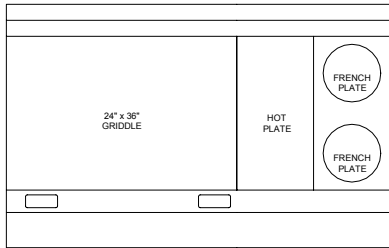

500S-E

48"x24" Griddle controlled by four 450° thermostats, and one 12"x24" Hot top controlled by one 850° thermostat.

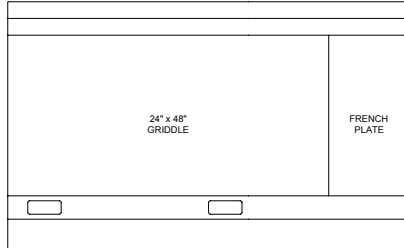

500S-F

48"x24" Griddle controlled by four 450° thermostats, and two French plates controlled by two 6-heat switches.

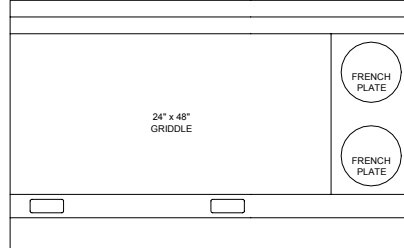

500S-G

60"x24" Griddle controlled by five 450° thermostats.

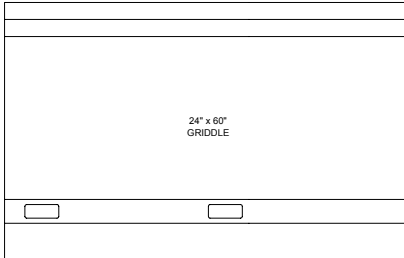

INSTALLATION

RECEIVING THE RANGE

Upon receipt, check for freight damage, both visible and concealed. Visible damage should be noted on the freight bill at the time of delivery and signed by the carrier's agent. Concealed loss or damage means loss or damage, which does not become apparent until the merchandise has been unpacked.

If concealed loss or damage is discovered upon unpacking, make a written request for inspection by the carrier's agent within 15 days of delivery. All packing material should be kept for inspection.

Do not return damaged merchandise to Lang Manufacturing Company. File your claim with the carrier.

Prior to un-crating, move the range as near its intended location as practical. The crating will help protect the unit from the physical damage normally associated with moving it through hallways and doorways.

ELECTRICAL CONNECTION

All connections can be made through 1 3/4" hole in the bottom of the oven.

Connections should be made to the wires coming from the circuit breaker.

For phasing and amperage requirements see pages 13&14.

LEG INSTALLATION

Remove the oven legs from the oven and screw the legs into the threaded hole provided on the bottom of the oven.

PHASING

| POWER SUPPLY | TERMINAL BLOCK | RANGE TOP |
|--------------|----------------|------------|
| SINGLE PHASE | L1 | 1,3,5,7,9 |
| | L2 | 2,4,6,8,10 |
| THREE PHASE | L1 | 1,4,7,10 |
| | L2 | 2,5,8 |
| | L3 | 3,6,9 |

500 Series Range

1) Verify connections at plug and terminal block.

2) Incoming Volt - Single Phase L1-L2 _____
 Three Phase L1-L2 _____ L2-L3 _____ L3-L1 _____

3) Amp draw L1 _____
 L2 _____
 L3 _____

4) Verify actual oven temperature at 350 °F _____ °F.

Note: Install thermocouple wire in center of oven and set Top 3-heat switch for HI and the Bottom 3-heat switch for LOW and let oven cycle for a minimum of three times.

Model # _____ Date _____ Serial # _____

Store # _____ Tech Name _____
Contact _____ Company _____
Store Phone # _____ Service Company Phone # _____

Address _____

GENERAL

The range is designed to give, well regulated, uniform heat throughout the ovens and over the surface units.

The ovens and surface units should be thoroughly preheated before being used. It is advantageous from an operating cost stand point to operate with the switches and/or thermostats set at the lowest position that will satisfactorily perform the cooking being done.

INITIAL PREHEAT

Before the initial use of the range, the ovens must be thoroughly allowed to dry out. This is done by setting the top and bottom oven switches to the "low" position, and setting the thermostat to 350 degrees. Allow the range ovens to saturate until all vapor and condensation has been eliminated. For best operating results allow the range ovens to thoroughly dry out. Allow 8 to 12 hours for this process. Clean top plates thoroughly. Apply salad oil. Turn each plate switch or thermostat to a low position and allow plate to heat for three hours.

OPERATION

The range ovens must be thoroughly, preheated before satisfactory baking can be done. The range ovens will not bake uniformly if not sufficiently preheated.

To compensate for temperature drop when loading the range ovens, set the thermostat up 50 degrees over the desired temperature. Reset thermostat after the ovens is loaded.

The range ovens may, of course, be preheated with the 3 heat switches set at a lower position than "High", but the time required will be proportionally longer. After preheating, set the two 3 heat switches for proper ratio of "top" and "bottom" heat to suit the product to be baked or roasted.

The 12" high "Roasting and Baking" range ovens is equipped with a removable rack. For baking pies, bread, or for roasting operations, the rack may be placed directly on the metal deck and the pans placed on the rack. For baking cakes or pastries the rack should be located in the lower position provided by the rack supports at the sides of the range and the pans placed on the rack in this lower position.

The following temperature, time, switch setting and rack positions are suggested as a guide in baking various classes of products:

| General Class of Product | Average Range Temperature | Time (Min.) | With Metal Switch Settings | | Rack Position |
|--------------------------|---------------------------|-------------|----------------------------|----------------|---------------|
| | | | Top | Bottom | |
| Pies | 375-425 | 35-60 | Low | Medium | Rack on Deck |
| Rolls | 375-400 | 15-30 | Low | High | Rack Support |
| Cake | 350-400 | 20-45 | Low | High | Rack Support |
| Pastries | 325-375 | 8-20 | Low | High | Rack Support |
| Bread | 425-450 | 25-45 | Low | Medium | Rack on Deck |
| Roast Beef | 300-325 | | Low | High or Medium | Rack on Deck |

RANGE TOP

Consists of the various top arrangements, depending on specific model purchased:

12" x 24" hot plate controlled by high temperature thermostats. Temperature ranges from 0°-850°. Recommended: Stock pots and heavy kettle work.

Round French Plates, controlled by indicating type 6-heat switch. Temperature ranges from 0°-750°. Recommended: Light duty sauce pans and small stockpots. Not Recommended: Heavy stock pots, or heavy urns, or kettles.

36" x 24" or 24" x 24" grill plates, controlled by thermostats. Temperature ranges from 0°-450°. Recommended: All heavy and light frying. Set the thermostat dial at the desired temperature. The red pilot light will be on until the desired temperature is reached. The pilot light indicates when the plate is heating.

CARE AND CLEANING

The range should be thoroughly cleaned at least once a week in addition to the normal daily cleaning to insure against the accumulation of foreign material. Keep inside of oven and metal deck clean, particularly around door opening, door edges and at bottom of door opening so that the door may close tightly. CAUTION: ANY OVEN CLEANER USED SHOULD BE MARKED: "SAFE ON ALUMINUM".

Keep-drip pans under range top plates clean.

Keep hotplate and griddle surfaces clean.

Outside of range and top should be kept clean.

Electric equipment is inherently clean and sanitary, but may become unsanitary if dirt is allowed to accumulate on it. Take advantage of the clean, sanitary features of electric equipment, give it the regular attention that it deserves the same as any other highly perfected machinery, to insure best results and continued high operating efficiency.

CALIBRATION

Calibration Check

- Place thermometer or thermocouple in the center of oven cavity.
- Set thermostat to 350° and place both 3-heat switches in the "HIGH" position.
- Allow the oven to Preheat for at least half an hour.
- Note cycle on temperatures and cycle off temperatures for 3 cycles. (Red indicator light indicates when oven is calling for heat)
- After 3 cycles average the temperature. (Add all six temperatures and divide by 6)

Calibration Adjustment

- A 1/16" flat blade screwdriver with a 2" shaft is required to make adjustments on the thermostat.
- Maintain the oven temperature at 350°.
- Without turning the thermostat, remove the knob.
- Locate the adjustment screw at the base of the shaft and insert the screwdriver.
- Grasp the shaft and turn the screwdriver. Counter clockwise to increase and clockwise to decrease. (1/8 of a turn will move the temperature 5-7 ° in either direction.)
- Reinstall the oven knob and recheck the oven temperature.

SEQUENCE OF OPERATION

OVEN

208/ 240 VAC to Thermostat.

Thermostat turned on.

208/ 240 VAC 3-Heat Switch.

3-Heat switch turned on.

208/ 240 VAC to elements.

HOT TOP

208/ 240 VAC to thermostat.

Thermostat turned on.

208/ 240 VAC to elements.

FRENCH PLATE

208/ 240 VAC to 6-heat switch.

6-Heat switch turned on.

208/240 VAC to French plates.

GRIDDLE

208/ 240 VAC to Thermostat.

Thermostat turned on.

208/ 240 VAC to elements.

OVEN

OVEN WILL NOT HEAT

| PROBABLE CAUSE | CORRECTIVE ACTION |
|--------------------------------|---|
| Incorrect wiring | <ul style="list-style-type: none"> ➤ Confirm that oven is getting proper voltage. ➤ Confirm that range is phased correctly. |
| Defective Thermostat | <ul style="list-style-type: none"> ➤ Confirm that thermostat is getting correct voltage. ➤ Confirm that thermostat was operating properly. |
| Defective 3-heat switch | <ul style="list-style-type: none"> ➤ Confirm that 3-heat switch is getting correct voltage. ➤ Confirm that 3-heat switch is operating properly. |
| Defective Element | <ul style="list-style-type: none"> ➤ Check element for normal operation. (See Technical Data) |

HOT TOP

HOT TOP WILL NOT HEAT

| PROBABLE CAUSE | CORRECTIVE ACTION |
|--------------------------------|---|
| Incorrect wiring | <ul style="list-style-type: none"> ➤ Confirm the hot top is wired correctly. ➤ Confirm that range is phased correctly. |
| Defective 3-Heat switch | <ul style="list-style-type: none"> ➤ Confirm that switch is wired correctly. ➤ Confirm that switch is operating correctly. |
| Defective Hot Top | <ul style="list-style-type: none"> ➤ Confirm that Hot Tops are getting correct voltage. ➤ Confirm that Hot Tops are operating correctly. (See Technical Data) |

FRENCH PLATE

FRENCH PLATE WILL NOT HEAT

| PROBABLE CAUSE | CORRECTIVE ACTION |
|--------------------------------|---|
| Incorrect wiring | <ul style="list-style-type: none"> ➤ Confirm the French Plate is wired correctly. ➤ Confirm that range is phased correctly. |
| Defective 6-Heat switch | <ul style="list-style-type: none"> ➤ Confirm that switch is wired correctly. ➤ Confirm that switch is operating correctly. |
| Defective French Plate | <ul style="list-style-type: none"> ➤ Confirm that French Plate is getting correct voltage. ➤ Confirm that French Plate is operating correctly. (See Technical Data) |

GRIDDLE

GRIDDLE IS NOT HEATING

| PROBABLE CAUSE | CORRECTIVE ACTION |
|-----------------------------|--|
| Incorrect wiring | <ul style="list-style-type: none">➤ Confirm the griddle is wired correctly.➤ Confirm that range is phased correctly. |
| Defective Thermostat | <ul style="list-style-type: none">➤ Confirm that thermostat is wired correctly.➤ Confirm that thermostat is operating correctly. |
| Defective Element | <ul style="list-style-type: none">➤ Confirm that Element is getting correct voltage.➤ Confirm that Element is operating correctly. (See Technical Data) |

OVEN ELEMENT RESISTANCE

| VOLTS | PART # | RESISTANCE | AMPS |
|----------------|----------|------------|------|
| ➤ 208 Volt I/S | 11050-32 | 36 Ω | 6 |
| ➤ 208 Volt O/S | 11050-31 | 34 Ω | 8.5 |
| ➤ 240 Volt I/S | 11050-26 | 48 Ω | 5 |
| ➤ 240 Volt O/S | 11050-25 | 32 Ω | 7.5 |
| ➤ 480 Volt I/S | 11050-30 | 192 Ω | 2.5 |
| ➤ 480 Volt O/S | 11050-29 | 128 Ω | 3.75 |

HOT TOP RESISTANCE

| VOLTS | PART# | PIN # | RESISTANCE | AMPS |
|----------|-----------|-------|------------|------|
| 208 Volt | 11010-341 | 1-2 | 46.0 Ω | 24 |
| | | 1-3 | 68.8 Ω | |
| | | 1-4 | 23.2 Ω | |
| | | 2-3 | 23.0 Ω | |
| | | 2-4 | 23.4 Ω | |
| | | 3-4 | 46.0 Ω | |
| 240 Volt | 11010-351 | 1-2 | 61.5 Ω | 21 |
| | | 1-3 | 92.2 Ω | |
| | | 1-4 | 30.9 Ω | |
| | | 2-3 | 30.9 Ω | |
| | | 2-4 | 31.2 Ω | |
| | | 3-4 | 61.8 Ω | |
| 480 Volt | 11010-361 | 1-2 | 249.0 Ω | 10.5 |
| | | 1-3 | 372.0 Ω | |
| | | 1-4 | 124.8 Ω | |
| | | 2-3 | 124.2 Ω | |
| | | 2-4 | 124.7 Ω | |
| | | 3-4 | 248.7 Ω | |

FRENCH PLATE RESISTANCE

| VOLTS | PART# | PIN # | RESISTANCE | AMPS |
|----------|----------|-------|------------|------|
| 208 Volt | 11120-12 | 1-2 | 130 Ω | 12.5 |
| | | 1-3 | 160 Ω | |
| | | 1-4 | 45.0 Ω | |
| | | 2-3 | 29.0 Ω | |
| | | 2-4 | 84.0 Ω | |
| | | 3-4 | 114 Ω | |
| 240 Volt | 11120-13 | 1-2 | 173 Ω | 11 |
| | | 1-3 | 212 Ω | |
| | | 1-4 | 59.0 Ω | |
| | | 2-3 | 39.0 Ω | |
| | | 2-4 | 114 Ω | |
| | | 3-4 | 153 Ω | |
| 480 Volt | 11120-14 | 1-2 | 690 Ω | 5.5 |
| | | 1-3 | 239 Ω | |
| | | 1-4 | 850 Ω | |
| | | 2-3 | 453 Ω | |
| | | 2-4 | 158 Ω | |
| | | 3-4 | 610 Ω | |

GRIDDLE & TOP PLATE ELEMENTS

| VOLTS | PART # | RESISTANCE | AMPS |
|----------------|----------|------------|------|
| ➤ 208 Volt I/S | 11010-10 | 14.5 Ω | 14.5 |
| ➤ 208 Volt O/S | 11010-09 | 21.5 Ω | 9.5 |
| ➤ 240 Volt I/S | 11010-22 | 19.0 Ω | 12.5 |
| ➤ 240 Volt O/S | 11010-21 | 28.0 Ω | 8.0 |
| ➤ 480 Volt I/S | 11010-24 | 76.0 Ω | 6.0 |
| ➤ 480 Volt O/S | 11010-23 | 115.0 Ω | 4.0 |

6-HEAT SWITCH WIRING

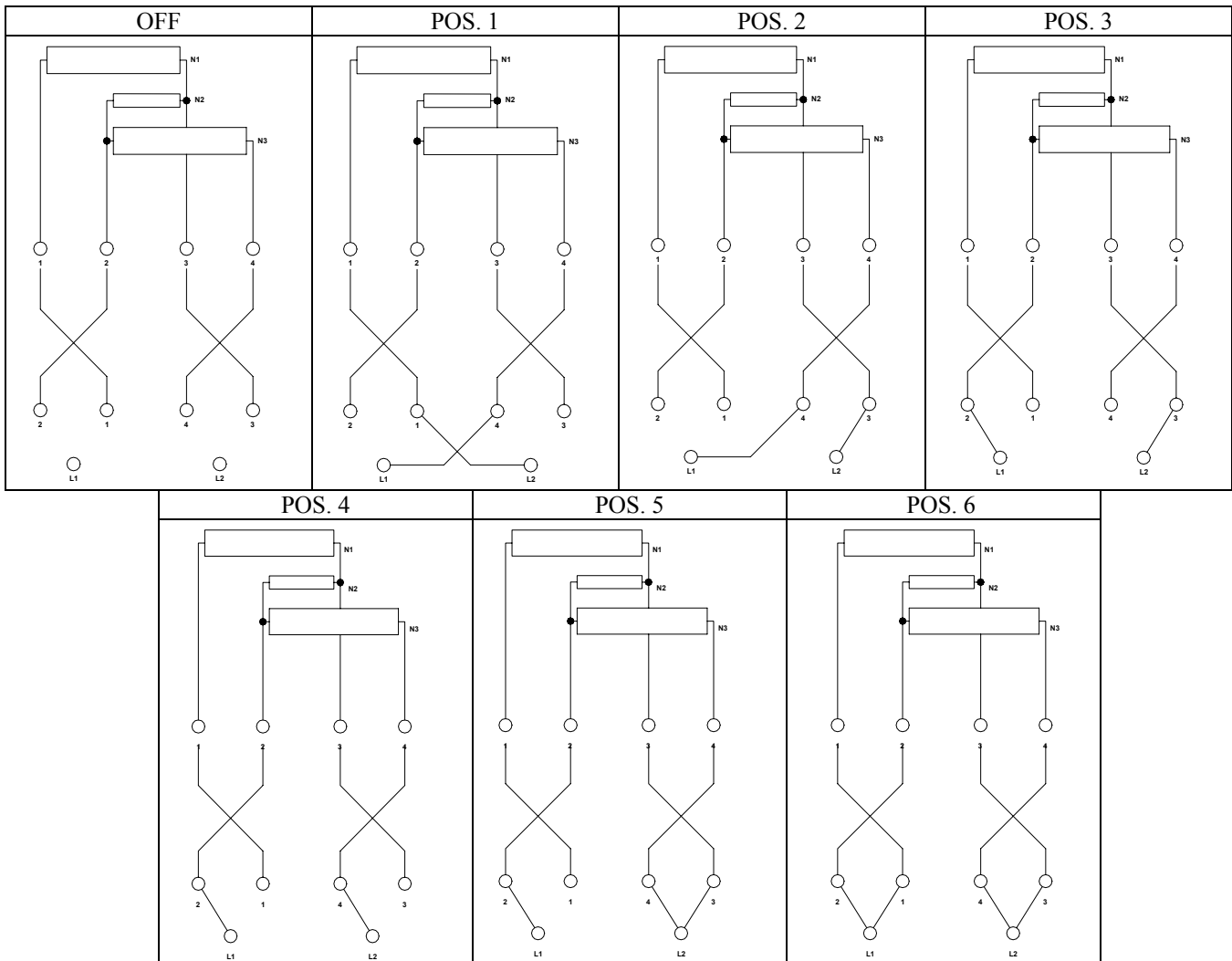

3-HEAT SWITCH WIRING

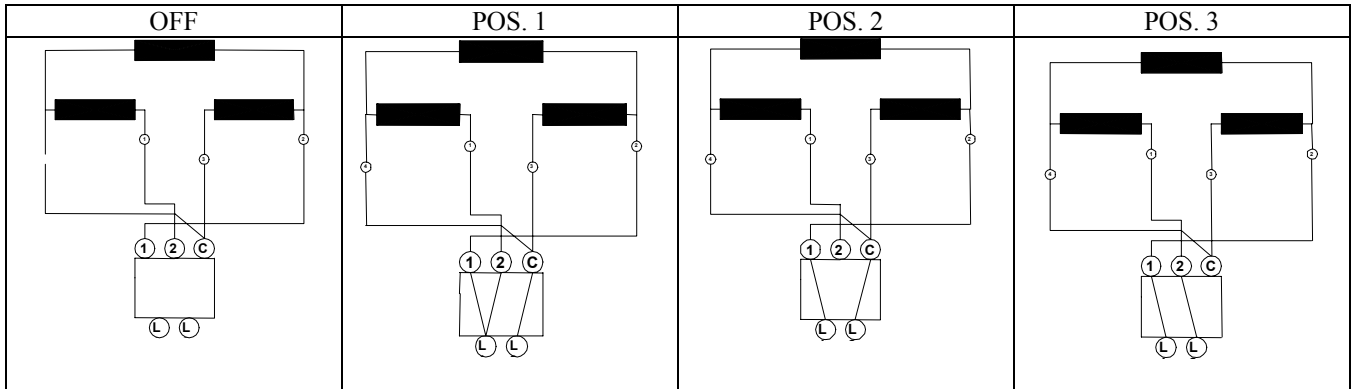

GRIDDLE LINE AMPERAGE, AND WATTAGE

| Model Number | Total K.W. Each Conn. | Nominal Amps Per Line at Each Connection | | | | | | | | | Shipping Weight | | |
|--------------|-----------------------|--|-------|-------|-----------|------|------|-----------|------|------|-----------------|--------------|----------|
| | | Three Phase | | | | | | | | | | Single Phase | |
| | | 208 Volts | | | 240 Volts | | | 480 Volts | | | | 208V | 240V |
| | | L1 | L2 | L3 | L1 | L2 | L3 | L1 | L2 | L3 | | | |
| Range | 37.0 | 108.3 | 100.0 | 100.0 | 93.9 | 86.7 | 86.7 | 46.9 | 43.3 | 43.3 | 177.9 | 154.2 | 900 lbs. |

WIRING DIAGRAM 500S 208/240

| MODEL DESIGNATION | | TOP ARRANGEMENT | | | | |
|-------------------|-----------|-----------------|-----------|-----------|-----------|-----------|
| | | SECTION 1 | SECTION 2 | SECTION 3 | SECTION 4 | SECTION 5 |
| 500S-A | *500S-ACT | B | B | B | B | B |
| 500S-B | *500S-BCT | B | B | B | B | C |
| 500S-C | *500S-CCT | A | A | B | B | C |
| 500S-D | *500S-DCT | A | A | A | B | C |
| 500S-E | *500S-ECT | A | A | A | A | A |
| 500S-F | *500S-FCT | A | A | A | A | C |
| 500S-G | *500S-GCT | A | A | A | A | A |

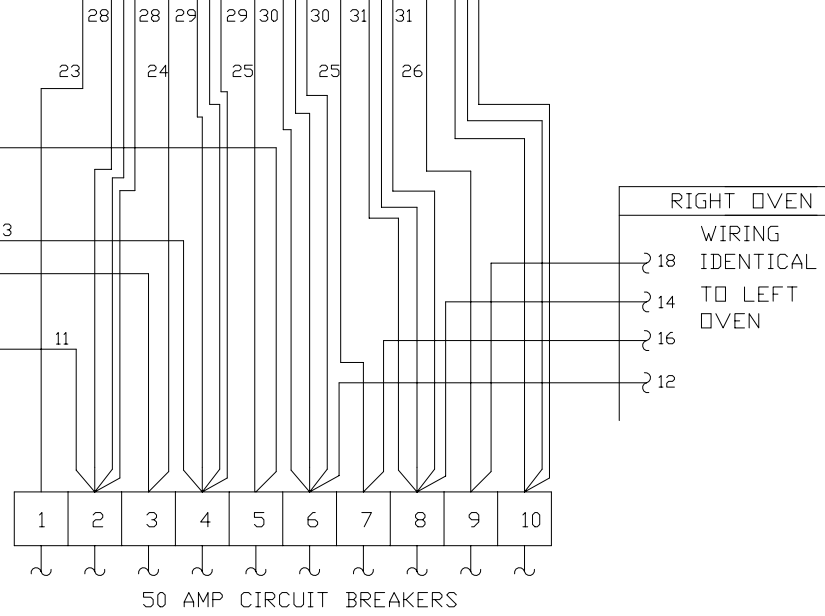
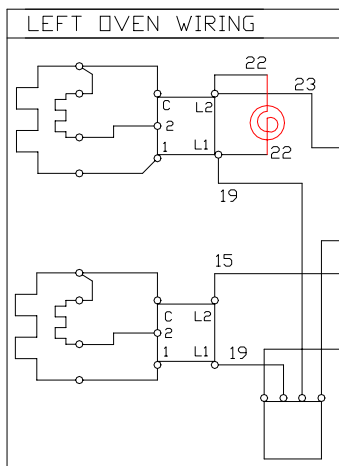

| SERVICE CONNECTION | | |
|--------------------|----|------------|
| SINGLE PHASE | L1 | 1,3,5,7,9 |
| | L2 | 2,4,6,8,10 |
| THREE PHASE | L1 | 1,4,7,10 |
| | L2 | 2,5,8 |
| | L3 | 3,6,9 |

| KW PER PHASE - RANGE | | |
|----------------------|-------|-------|
| L1-L2 | L2-L3 | L3-L1 |
| 13 | 11 | 13 |

| KW PER PHASE - COOK TOP | | |
|-------------------------|-------|-------|
| L1-L2 | L2-L3 | L3-L1 |
| 10 | 5 | 10 |

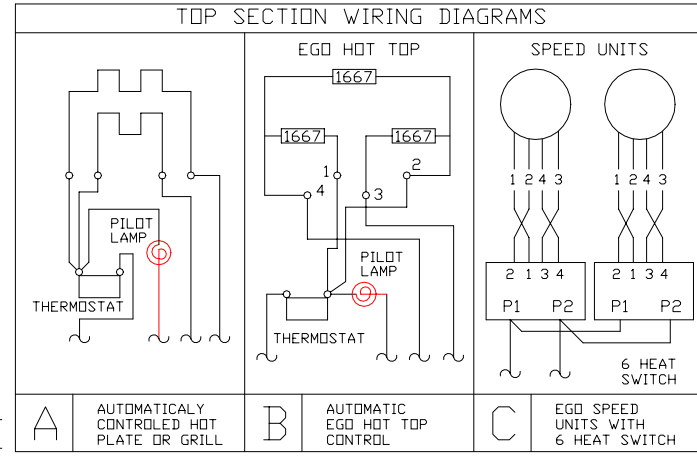

- NOTES:
- EXAMPLE FOR DETERMINING THE WIRING OF A LANG RANGE
 1.1 VIEWED FROM THE FRONT, LEFT TO RIGHT, THE TOP 1 FOOT SECTIONAL ARRANGEMENT FOR THE 500S-C RANGE IS A,A,B,B,C (AS DETERMINED BY THE TOP ARRANGEMENT CHART) EACH OF THE LETTERS REPRESENT ONE OF THE TYPICAL WIRING DIAGRAMS SHOWN ABOVE.
 - THE POWER INPUT LEADS TO EACH TOP SECTION AND THE OVEN ARE SHOWN IN THE DIAGRAM AT THE LEFT CONNECTED TO THEIR RESPECTIVE CIRCUIT BREAKERS.
 - PROPER RANGE PHASING AND POWER DISTRIBUTION TO EACH CIRCUIT MAY BE DETERMINED BY REFERRING TO THE SERVICE CONNECTION CHART.
 - COOK TOP ONLY - DELETE OVEN CIRCUITS

500S RANGE WITH EGO HOT TOPS
 USE QN (E) SERIAL NO. AND QN

RANGE TOP WIRING

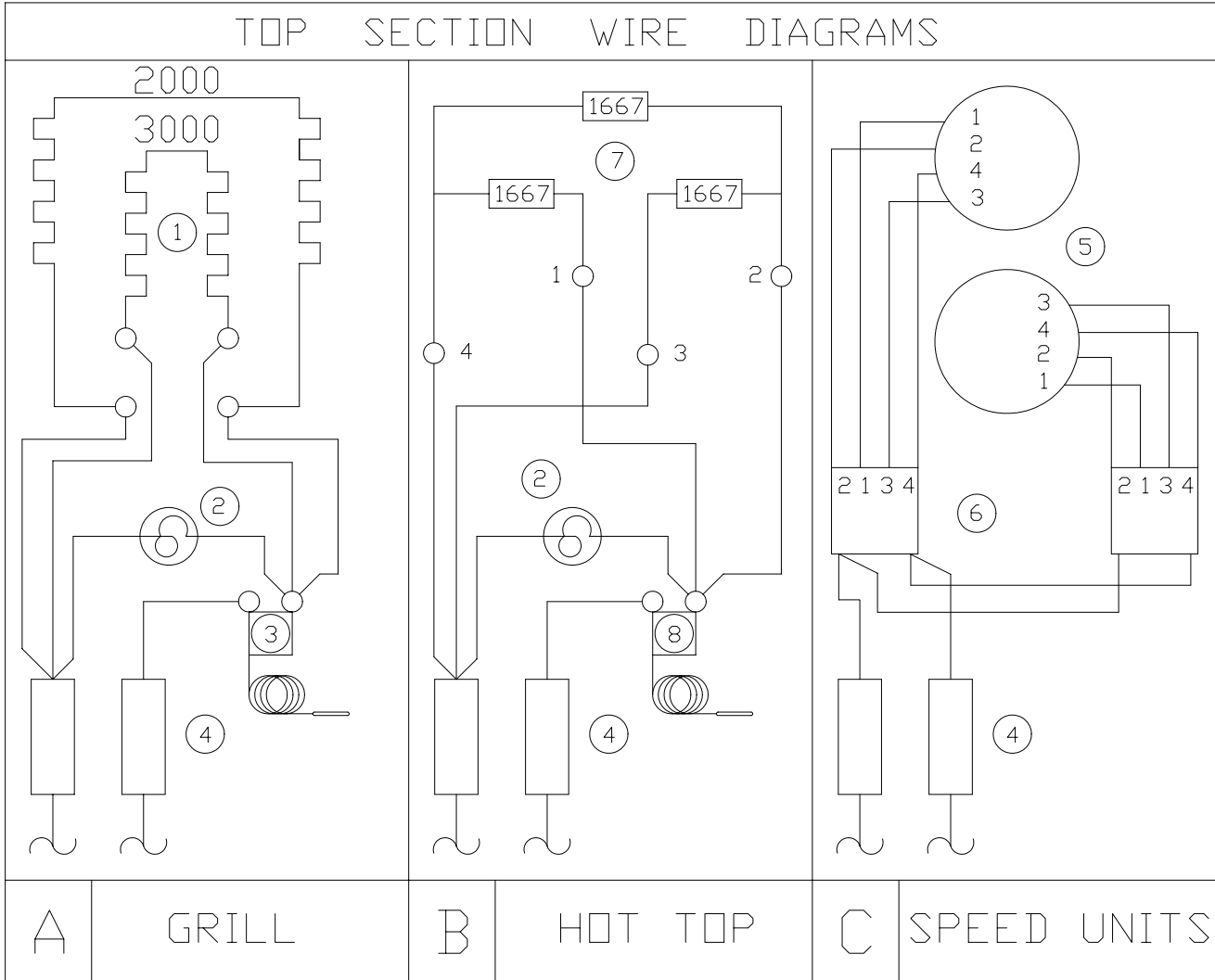

1. Griddle and Top Plate Element
2. Pilot Light
3. 450° Griddle thermostat
4. Circuit breakers
5. French plate
6. 6-Heat switch
7. Hot Top
8. 800° Hot Top thermostat.

500S 480 WIRING DIAGRAM

| MODEL | TOP ARRANGEMENT | | | | |
|--------|-----------------|-----------|-----------|-----------|-----------|
| | SECTION 1 | SECTION 2 | SECTION 3 | SECTION 4 | SECTION 5 |
| 500S-A | B | B | B | B | B |
| 500S-B | B | B | B | B | C |
| 500S-C | A | A | B | B | C |
| 500S-D | A | A | A | B | C |
| 500S-E | A | A | A | A | B |
| 500S-F | A | A | A | A | C |
| 500S-G | A | A | A | A | A |

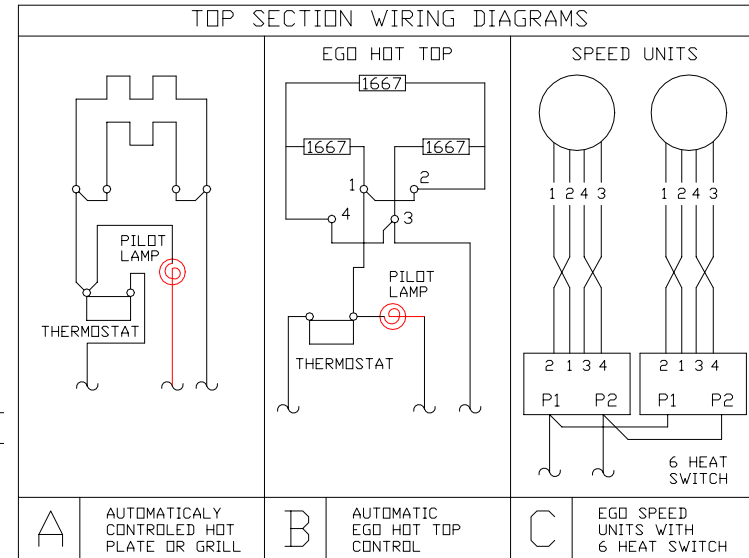
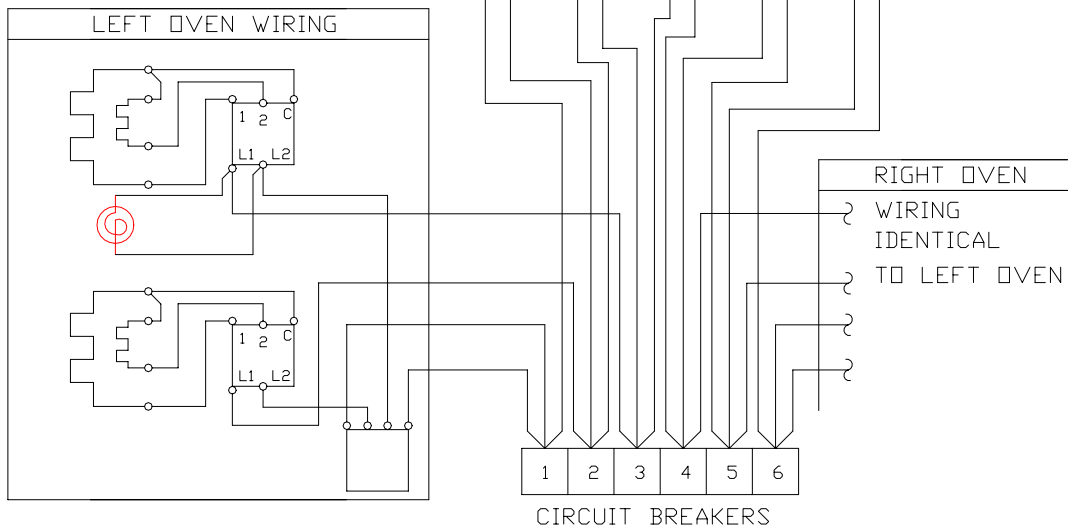

| SERVICE CONNECTION | | |
|--------------------|-------|-----|
| THREE PHASE | L1 | 1,4 |
| | L2 | 2,5 |
| | L3 | 3,6 |
| KW PER PHASE | L1-L2 | 13 |
| | L2-L3 | 13 |
| | L3-L1 | 11 |

NOTES:

- EXAMPLE FOR DETERMINING THE WIRING OF A LANG RANGE
 1.1 VIEWED FROM THE FRONT, LEFT TO RIGHT, THE TOP 1 FOOT SECTIONAL ARRANGEMENT FOR THE 500S-C RANGE IS A,A,B,B,C (AS DETERMINED BY THE TOP ARRANGEMENT CHART) EACH OF THE LETTERS REPRESENT ONE OF THE TYPICAL WIRING DIAGRAMS SHOWN ABOVE.
- THE POWER INPUT LEADS TO EACH TOP SECTION AND THE OVEN ARE SHOWN IN THE DIAGRAM AT THE LEFT CONNECTED TO THEIR RESPECTIVE CIRCUIT BREAKERS.
- PROPER RANGE PHASING AND POWER DISTRIBUTION TO EACH CIRCUIT MAY BE DETERMINED BY REFERRING TO THE SERVICE CONNECTION CHART.

500S RANGE WITH EGO HOT TOPS
 USE ON SERIAL NO. AND ON

500S**ELECTRIC RANGE**

| DESCRIPTION | PART NO. |
|--|-----------------|
| Element Top Plate 208V O/S 2000 Watts | 11010-09 |
| Element Top Plate 208V I/S 3000 Watts | 11010-10 |
| Element Top Plate 240V O/S 2000 Watts | 11010-21 |
| Element Top Plate 240V I/S 3000 Watts | 11010-22 |
| Element Top Plate 480V O/S 2000 Watts | 11010-23 |
| Element Top Plate 480V I/S 3000 Watts | 11010-24 |
| Element Top Plate 380V O/S 2000 Watts | 11010-25 |
| Element Top Plate 380V I/S 3000 Watts | 11010-26 |
| Hot Plate Cast Assy. w/ Elements 208V 5000 Watts (After E-83890) | 11010-341 |
| Hot Plate Cast Assy. w/ Elements 240V 5000 Watts (After E-83890) | 11010-351 |
| Hot Plate Cast Assy. w/ Elements 480V 5000 Watts (After E-83890) | 11010-361 |
| Element 36 Oven 240 Volt O/S 1800 Watts | 11050-25 |
| Element 36 Oven 240 Volt I/S 1200 Watts | 11050-26 |
| Element 36 Oven 480 Volt O/S 1800 Watts | 11050-29 |
| Element 36 Oven 480 Volt I/S 1200 Watts | 11050-30 |
| Element 36 Oven 208 Volt O/S 1800 Watts | 11050-31 |
| Element 36 Oven 208 Volt I/S 1200 Watts | 11050-32 |
| Element 36 Oven 380 Volt O/S 1800 Watts | 11050-33 |
| Element 36 Oven 380 Volt I/S 1200 Watts | 11050-34 |
| Element Speed Unit 208 Volt 2100 Watts (Before C-42132) | 11120-01 |
| Element Speed Unit 240 Volt 2100 Watts (Before C-42132) | 11120-02 |
| Element Speed Unit 480 Volt 2100 Watts (Before C-35145) | 11120-10 |
| Element French Plate 208 Volt 2600 Watts (After C-42133) | 11120-12 |
| Element French Plate 240 Volt 2600 Watts (After C-42133) | 11120-13 |
| Element French Plate 480 Volt 2600 Watts (After C-35145) | 11120-14 |
| Speed Unit Bowl 208/240 Volt (Before C-42132) | 11120-15 |
| Speed Unit Spider 208/240 Volt (Before C-42132) | 11120-16 |
| Element French Plate 380 Volt 2000 Watts | 11120-18 |
| Speed Unit Ring 208/240 Volt (Before C-42132) | 11120-19 |
| Speed Unit Bowl/Ring Assembly 480 Volt (Before C-35145) | 11120-20 |
| Switch Rotating 3 Heat | 30304-06 |
| Switch Rotating 6 Heat + Off (After C-35145) | 30304-09 |
| Switch Infinite Control (Before C-35145) | 30305-01 |
| Thermostat 450°F Oven/Griddle | 30402-08 |
| Thermostat 550°F Oven | 30402-09 |
| Thermostat 800°F Hot Top (Before C-35145) | 30402-10 |
| Thermostat 850°F Hot Top (After C-35145) | 30402-23 |
| Terminal Block 3 Pole | 30500-07 |
| Contactors 2 Pole 208/240 VAC (Before C-35145) | 30701-02 |
| Timer Mechanical Long Ring (380 Volt Units Only) | 30801-01 |
| Fuse 30 Amp 480 Volt Units (Before C-42132) | 30900-06 |
| Fuse 50 Amp 208/240 Volt Units (Before C-42132) | 30900-09 |
| Fuse Block 2 Pole 30 Amp 480 Volt Units (Before C-42132) | 30901-05 |
| Fuse Block 2 Pole 60 Amp 208/240 Volt Units (Before C-42132) | 30901-06 |
| Transformer 480/240 VAC (Before C-42132) | 31400-04 |
| Pilot Light 208/240V 6" Lead Black Body | 31601-01 |
| Pilot Light 480V 6" Lead Black Body | 31601-02 |
| Circuit Breaker 208/240 Volt 1 Pole | 31800-02 |
| Element Pan Assembly w/ Snout | 50300-20 |
| Speed Unit Frame Assembly (Before C-42132) | 50300-29 |
| French Plate Frame Assembly (After C-35145) | 50300-82 |
| Element Clip Long | 50301-09 |

500S**ELECTRIC RANGE**

| DESCRIPTION | PART NO. |
|--|-----------------|
| Element Clip Short | 50301-10 |
| Element Bushing Metal | 50301-11 |
| Hot Top Assembly 3/4" x 1ft (Before D-83889) | 50400-02 |
| Range Plate Assembly 1/2" x 1ft | 50401-01 |
| Range Plate Assembly 1/2" x 2ft | 50401-02 |
| Range Plate Assembly 1/2" x 3ft | 50401-03 |
| Tension Disc Oven Door | 50800-07 |
| Spring Left Side 7 1/2" Long – Oven Door | 51001-01 |
| Spring Right Side 7 1/2" Long – Oven Door | 51001-02 |
| Grease Drawer | 60102-292 |
| Handle Assembly Oven Door | 70603-05 |
| Knob Infinite Control (Before C-35145) | 70701-04 |
| Knob Manual Timer (380 Volt Units Only) | 70701-09 |
| Knob 3 Heat Switch | 70701-10 |
| Knob Thermostat 550°F Oven | 70701-12 |
| Knob Thermostat 450°F Griddle/Oven | 70701-16 |
| Knob Thermostat 800°F Hot Top (Before C-35145) | 70701-20 |
| Knob Damper Black (380 Volt Units Only) | 70701-25 |
| Knob Thermostat 850°F Hot Top (After C-35145) | 70701-35 |
| Knob 6 Heat Switch (After C-35145) | 70701-41 |