

Hot Deli Display Island

MODELS BHI-4, BHI-4T, BHI-5 & BHI-5T

Service Manual

Serial Numbers 128049 and Higher



Fresh ideas in foodservice equipment

BKI LIMITED WARRANTY

2812 Grandview Dr. • Simpsonville, SC 29680 • USA
(864) 963-3471 • Toll Free: (800) 927-6887 • Fax: (864) 963-5316

WHAT IS COVERED

This warranty covers defects in material and workmanship under normal use, and applies only to the original purchaser providing that:

- The equipment has not been accidentally or intentionally damaged, altered or misused;
- The equipment is properly installed, adjusted, operated and maintained in accordance with national and local codes, and in accordance with the installation and operating instructions provided with this product.
- The serial number rating plate affixed to the equipment has not been defaced or removed.

WHO IS COVERED

This warranty is extended to the original purchaser and applies only to equipment purchased for use in the U.S.A.

COVERAGE PERIOD

- Warranty claims must be received in writing by BKI within one (1) year from date of installation or within one (1) year and three (3) months from data of shipment from the factory, whichever comes first.
- COB Models: One (1) Year limited parts and labor.
- COM Models: Two (2) Year limited parts and labor. COM convection ovens also have a two (2) year door warranty.
- CO1 Models: Two (2) Year limited parts and labor. Five (5) Year limited door warranty.
- BevLes Products: Two (2) Year limited parts and labor.
- Warranty period begins the date of dealer invoice to customer or ninety (90) days after shipment date from BKI, whichever comes first.

WARRANTY COVERAGE

This warranty covers on-site labor, parts and reasonable travel time and travel expenses of the authorized service representative up to (100) miles round trip and (2) hours travel time and performed during regular, weekday business hours.

EXCEPTIONS

Any exceptions must be pre-approved in advance and in writing by BKI. The extended door warranty on convection ovens years 3 through 5 is a parts only warranty and does not include labor, travel, mileage or any other charges.

EXCLUSIONS

- Negligence or acts of God,
- Thermostat calibrations after (30) days from equipment installation date,
- Air and gas adjustments,
- Light bulbs,
- Glass doors and door adjustments,
- Fuses,
- Adjustments to burner flames and cleaning of pilot burners,
- Tightening of screws or fasteners,
- Failures caused by erratic voltages or gas suppliers,
- Unauthorized repair by anyone other than a BKI Factory Authorized Service Center,
- Damage in shipment,
- Alteration, misuse or improper installation,
- Thermostats and safety valves with broken capillary tubes,
- Freight - other than normal UPS charges,
- Ordinary wear and tear,
- Failure to follow installation and/or operating instructions,
- Events beyond control of the company.

INSTALLATION

Leveling, as well as proper installation and check out of all new equipment - per appropriate installation and use materials - is the responsibility of the dealer or installer, not the manufacturer.

REPLACEMENT PARTS

BKI genuine Factory OEM parts receive a (90) day materials warranty effective from the date of installation by a BKI Factory Authorized Service Center.

Table of Contents

Table of Contents	1
Introduction	2
Safety Precautions.....	2
Safety Signs and Messages.....	2
Safe Work Practices.....	3
Safety Labels.....	4
Operation	5
Controls and Indicators.....	5
Unit Startup and Preheating	6
BHI.....	6
BHI-T	6
Temperature Adjustment	6
Operational Guidelines	7
Unit Shutdown	7
Installation	8
Instructions For Shipping Damage	8
Location and Placement.....	8
Wiring.....	8
Maintenance	9
Scheduled Maintenance	9
Cleaning	9
Troubleshooting	10
Replacement Parts	11
BHI.....	11
BHI-T	12
Wiring Diagrams	13
Notes	21

Introduction

Congratulations! You have chosen a **Hot Deli Display Island** that will give you many years of fine service from the original manufacturer, **BKI**.

The **BKI** name and trademark on this unit assures you of the finest in design and engineering — that it has been built with care and dedication — using the best materials available. Attention to the operating instructions regarding proper installation, operation, and maintenance will result in long lasting dependability to insure the highest profitable return on your investment.

NOTICE

PLEASE READ THIS ENTIRE MANUAL BEFORE OPERATING THE UNIT. If you have any questions, please contact your **BKI** Distributor. If they are unable to answer your questions, contact the **BKI** Technical Service Department, toll free: 1-800-927-6887. Outside the U.S., call 1-864-963-3471.

Safety Precautions

Always follow recommended safety precautions listed in this manual. Below is the safety alert symbol. When you see this symbol on your equipment, be alert to the potential for personal injury or property damage.



Safety Signs and Messages

The following Safety signs and messages are placed in this manual to provide instructions and identify specific areas where potential hazards exist and special precautions should be taken. Know and understand the meaning of these instructions, signs, and messages. Damage to the equipment, death or serious injury to you or other persons may result if these messages are not followed.

⚠ DANGER

This message indicates an imminently hazardous situation that, if not avoided, will result in death or serious injury.

⚠ WARNING

This message indicates a potentially hazardous situation, which, if not avoided, could result in death or serious injury.

⚠ CAUTION

This message indicates a potentially hazardous situation, which, if not avoided, may result in minor or moderate injury. It may also be used to alert against unsafe practices.

NOTICE

This message is used when special information, instructions or identification are required relating to procedures, equipment, tools, capacities and other special data.

Safe Work Practices

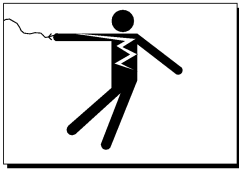
**Beware of High Voltage**

This equipment uses high voltage. Serious injury can occur if you or any untrained or unauthorized person installs, services, or repairs this equipment. Always Use an Authorized Service agent to Service Your Equipment.

**Keep this manual with the Equipment**

This manual is an important part of your equipment. Always keep it near for easy access. If you need to replace this manual, contact:

BKI

Technical Services Department
2812 Grandview Drive
Simpsonville, S.C. 29680
Or call toll free: 1-800-927-6887
Outside the U.S., call 864-963-3471

**Protect Children**

Keep children away from this equipment. Children may not understand that this equipment is dangerous for them and others.

NEVER allow children to play near or operate your equipment.

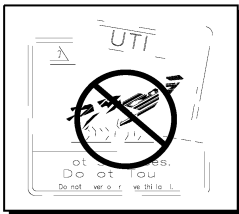
**Keep Safety Labels Clean and in Good Condition**

Do not remove or cover any safety labels on your equipment. Keep all safety labels clean and in good condition. Replace any damaged or missing safety labels. Refer to the Safety Labels section for illustration and location of safety labels on this unit. If you need a new safety label, obtain the number of the specific label illustrated on page 4, then contact:

BKI

Technical Services Department
2812 Grandview Drive
Simpsonville, S.C. 29680
Or call toll free: 1-800-927-6887
Outside the U.S., call 864-963-3471

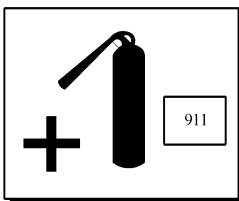
**Be Prepared for Emergencies**

Be prepared for fires, injuries, or other emergencies.

Keep a first aid kit and a fire extinguisher near the equipment. You must use a 40-pound Type BC fire extinguisher and keep it within 25 feet of your equipment.

Keep emergency numbers for doctors, ambulance services, hospitals, and the fire department near your telephone.

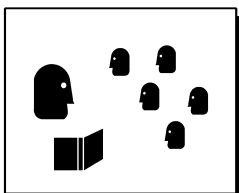
**Know your responsibilities as an Employer**

- Make certain your employees know how to operate the equipment.
- Make certain your employees are aware of the safety precautions on the equipment and in this manual.
- Make certain that you have thoroughly trained your employees about operating the equipment safely.
- Make certain the equipment is in proper working condition. If you make unauthorized modifications to the equipment, you will reduce the function and safety of the equipment.

Safety Labels

N0200



N0475

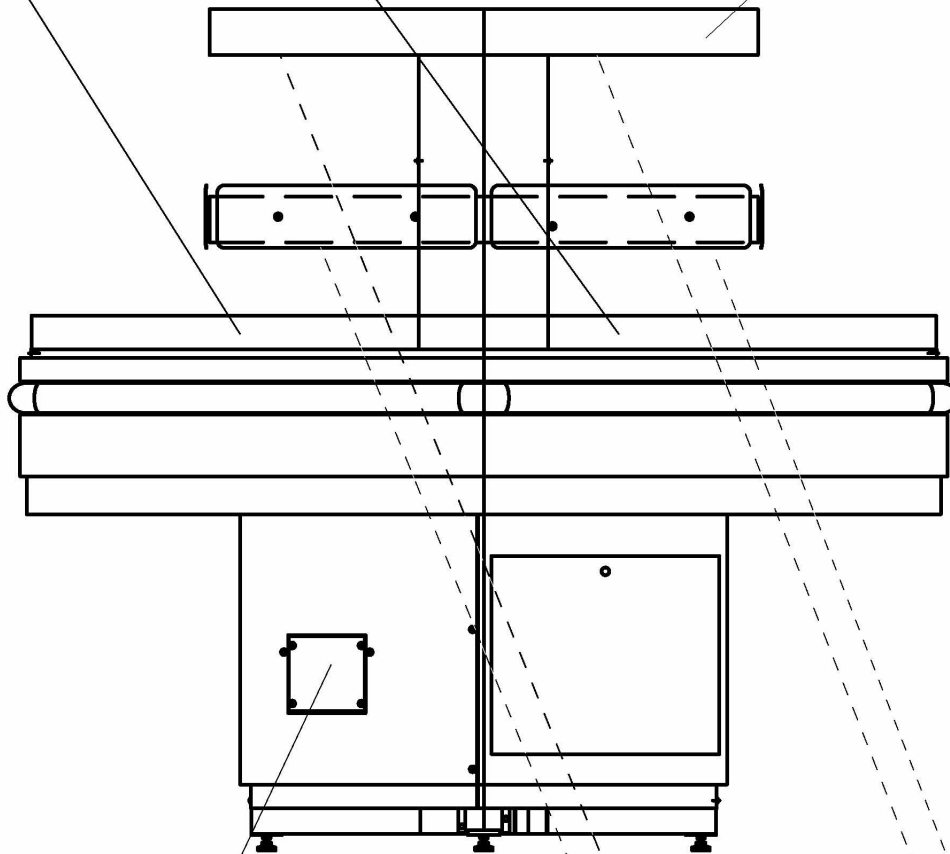
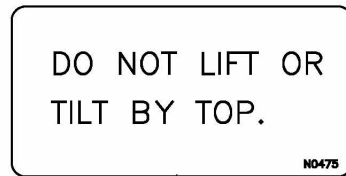

N0202



N0435

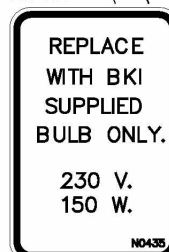

N0444

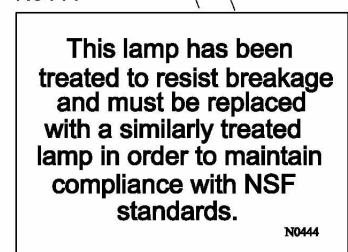

Operation

Controls and Indicators

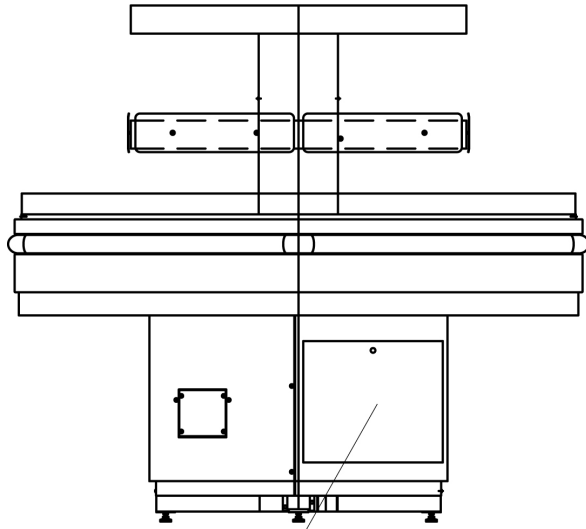

CONTROL PANEL
ACCESS DOOR

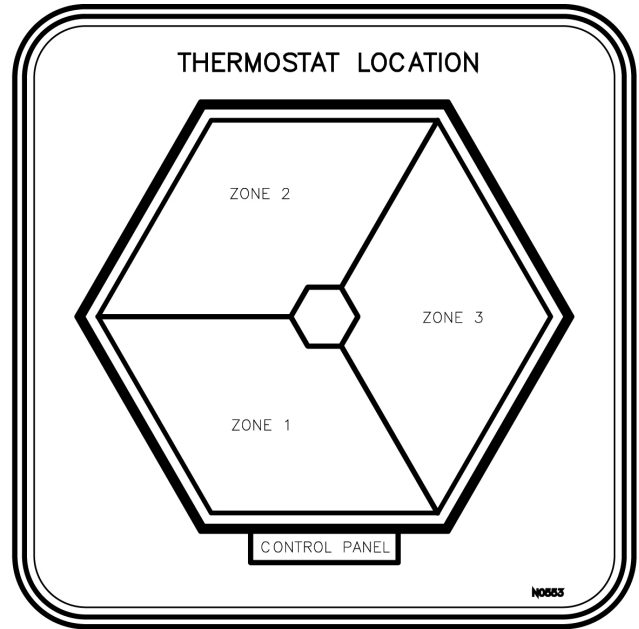

THERMOSTAT ZONE LOCATION DECAL
(ON BACK OF ACCESS DOOR)

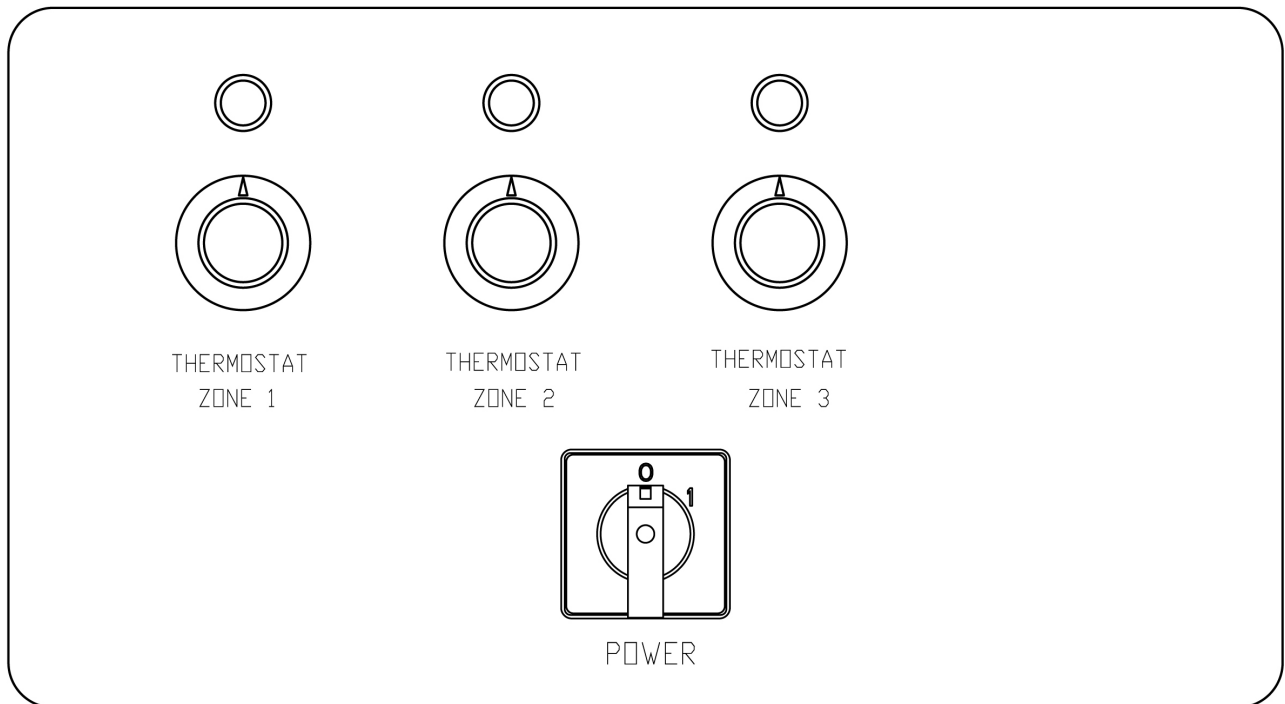

BHI CONTROL PANEL (BEHIND ACCESS DOOR)

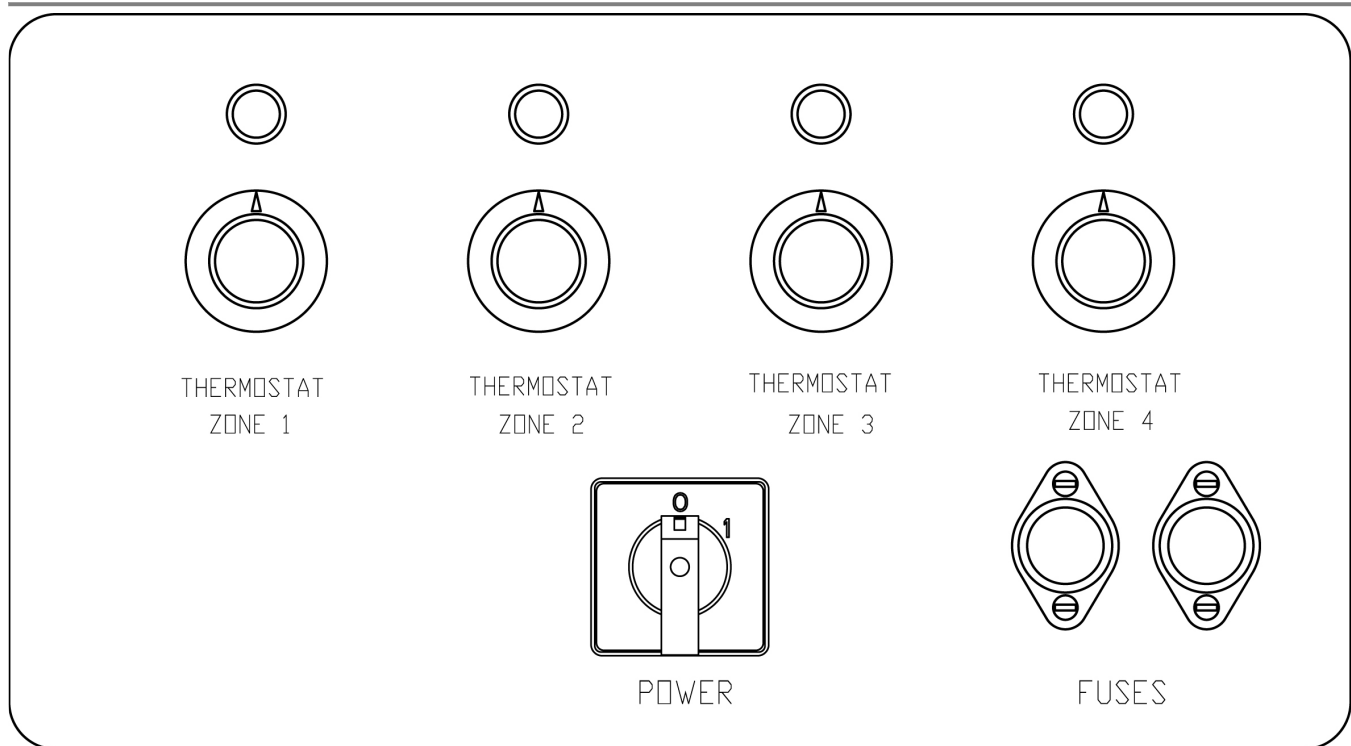

BHI-T CONTROL PANEL (BEHIND ACCESS DOOR)

Unit Startup and Preheating

BHI

1. Open the access door to the control panel and place the POWER switch in the **1** position.
2. Place THERMOSTAT ZONE knobs 1, 2 and 3 to the number 5 position. The pilot light for each thermostat will cycle on and off to indicate that proper temperature is being maintained for that zone.
3. Allow the equipment to preheat for 30 minutes before loading it with product.

BHI-T

1. Open the access door to the control panel and place the POWER switch in the **1** position.
2. Place THERMOSTAT ZONE knobs 1, 2 and 3 to the number 5 position. The pilot light for each thermostat will cycle on and off to indicate that proper temperature is being maintained for that zone.
3. Place THERMOSTAT ZONE knob 4 to the number 5 position. The pilot light for this thermostat will cycle on and off to indicate that proper temperature is being maintained for the upper shelf.
4. Allow the equipment to preheat for 30 minutes before loading it with product.

Temperature Adjustment

After loading the unit with product, it may be necessary to adjust the thermostat knobs in order to maintain the proper internal temperature for the product on display. The thermostat knobs should be set to the lowest possible number that will maintain the proper product temperature.

Operational Guidelines

- Foods should be a minimum of 160° F. before being placed in the unit.
- Foods loaded in first should be served first as much as is practical.
- Check Federal and State Health and Sanitation Regulations for internal temperature required for holding cooked foods for sale. Maintaining these temperatures often tends to continue to cook certain products. Therefore, smaller amounts of bulk foods should be displayed at non-peak periods and the warmer refilled as needed.

NOTICE

This equipment is designed to temporarily slow the cooking of food.

Unit Shutdown

1. Remove all food from the equipment.
2. Place the THERMOSTAT knobs to the OFF position.
3. Place the POWER switch to the **0** position.
4. Allow the equipment to cool to room temperature.
5. Remove any residue and clean the equipment thoroughly.

Installation

⚠ WARNING

Serious injury, equipment damage or death could result if attempting to install this unit yourself. Ensure that an authorized BKI service agent installs the unit.

Instructions For Shipping Damage

You are responsible for filing all freight claims with the delivering truck line. Inspect all cartons and crates for damage when they arrive. If there is damage noted to shipping crates or cartons, or, if a shortage is found, note this on the bill of lading (all copies) before signing.

If damage is detected when the equipment is uncrated, immediately call the delivering truck line and follow up the call with a written report indicating concealed damage to your equipment. Ask for an immediate inspection of your concealed damage item. Crating material **MUST** be retained to show the inspector from the truck line.

Location and Placement

Move the unit to a permanent location then level it using a 4' level and the leg levelers.

Wiring

⚠ WARNING

Electrocution, equipment failure or property damage could result if an unlicensed electrician performs the electrical installation. Ensure that a licensed electrician perform the electrical installation in accordance with local codes, or in the absence of local codes, with the National Electrical Code, ANSI NFPA 70-20XX.

This unit, when installed by an authorized BKI service agent, must be wired for use in accordance with all applicable local, state, and federal codes. For specific electrical requirements and connections refer to the wiring diagram attached to the unit or provided in the Service Manual.

NOTICE

The kickplates included with this product are to be installed, and the product is to be sealed to the floor prior to use.

Maintenance

⚠ CAUTION

Failure to comply with the maintenance below could result in a serious accident.

⚠ WARNING

Electrocution, equipment failure or property damage could result if an unlicensed electrician performs electrical repair. Ensure that a licensed electrician perform electrical repair.

Scheduled Maintenance

⚠ DANGER

Failure to remove power from this unit may cause severe electrical shock. This unit may have more than one disconnect switch.

⚠ CAUTION

Never use abrasive cleaners that may damage the finish.

Never steam clean the interior.

Avoid getting excess water in the interior of the unit.

Do not leave this unit on and unattended after business hours.

Cleaning

This unit should be cleaned at the end of each working day. Use the following procedure:

1. Remove all food from the equipment.
2. Place the THERMOSTAT ZONE knobs to the OFF position.
3. Place the POWER switch to the **0** position.
4. Cut OFF the circuit breaker supplying power to the unit at the building power panel.
5. Allow the equipment to cool to room temperature.
6. Remove any residue and clean the equipment thoroughly.
7. Sponge the inside and outside of the unit with a mild soap and water solution, being sure to clean all areas. Avoid getting water in the interior of the unit.
8. Wipe the parts and unit dry with a soft, clean cloth.

Troubleshooting

Problem	Cause	Possible Solution
No Heat and Lights	Main power switch is off.	Place main power switch on.
	No Power to the case.	Check circuit breaker or fuses at building power panel. If problem persists, contact an authorized BKI service agent for corrective action.
	Possible defective switch.	Contact an authorized BKI service agent for corrective action.
All Lights ON but No Heat from any Temperature Zone	Possible defective component in the heating circuit.	Contact an authorized BKI service agent for corrective action.
All Temperature Zones Heat but No Lights illuminate	Possible defective component in the lighting circuit.	Contact an authorized BKI service agent for corrective action.
All Lights are On and all Temperature Zones heat except one	Possible defective Heating Element or thermostat.	Contact an authorized BKI service agent for corrective action.
All Temperature Zones Heat and all lights are on except one	Possible bulb failure.	Replace bulb.
Holding Temperature Not Adequate	Unit and food pans have not been preheated.	Refer to the preheating section on page 6. If problem persists, contact an authorized BKI service agent for corrective action.
	One or more heating elements or thermostats not operating properly.	Contact an authorized BKI service agent for corrective action.
	Product is below 160° F when loaded.	Check product temperature before loading the case.

Replacement Parts

Use the information in this section to identify replacement parts. To order replacement parts, call your local BKI sales and service representative. Before calling, please note the serial number on the rating tag affixed to the unit.

BHI

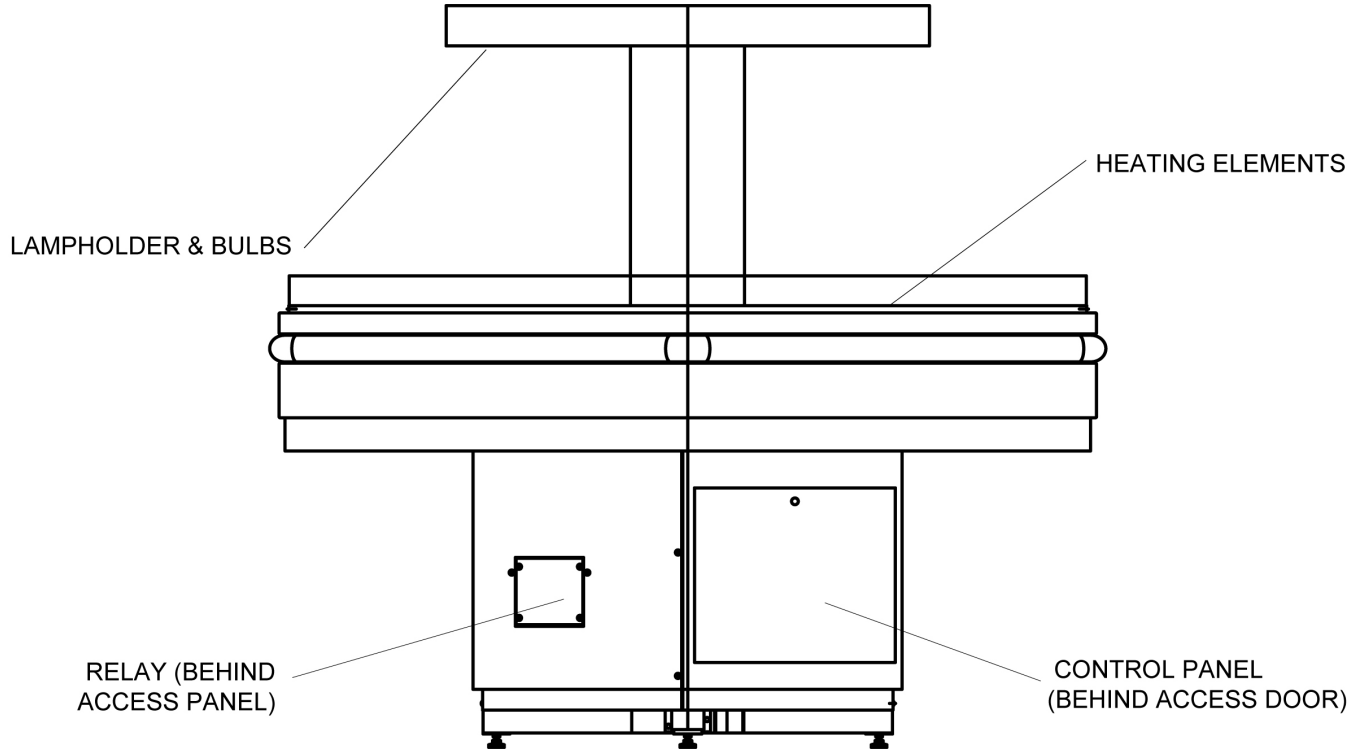

PART #	DESCRIPTION
B0555	BULB, 150W 240V HALOGEN COATED
LH0021	LAMPHOLDER, HI TEMP
C0766	HEATING ELEMENT, BHI-4, 208V
C0767	HEATING ELEMENT, BHI-4, 230V
C0751	HEATING ELEMENT, BHI-5, 208V
C0754	HEATING ELEMENT, BHI-5, 230V
B0090	BALLAST – 120V-277V, .28A
FL0047	FLUORESCENT BULB, T5, 14W W/ SHATTER SHIELD
CONTROL PANEL	
PL004	PILOT LIGHT, 250V, 10W
S0006	MAIN SWITCH, 600V, 30A
S0141	INFINITE SWITCH, 240V 13A
K0040	KNOB

BHI-T

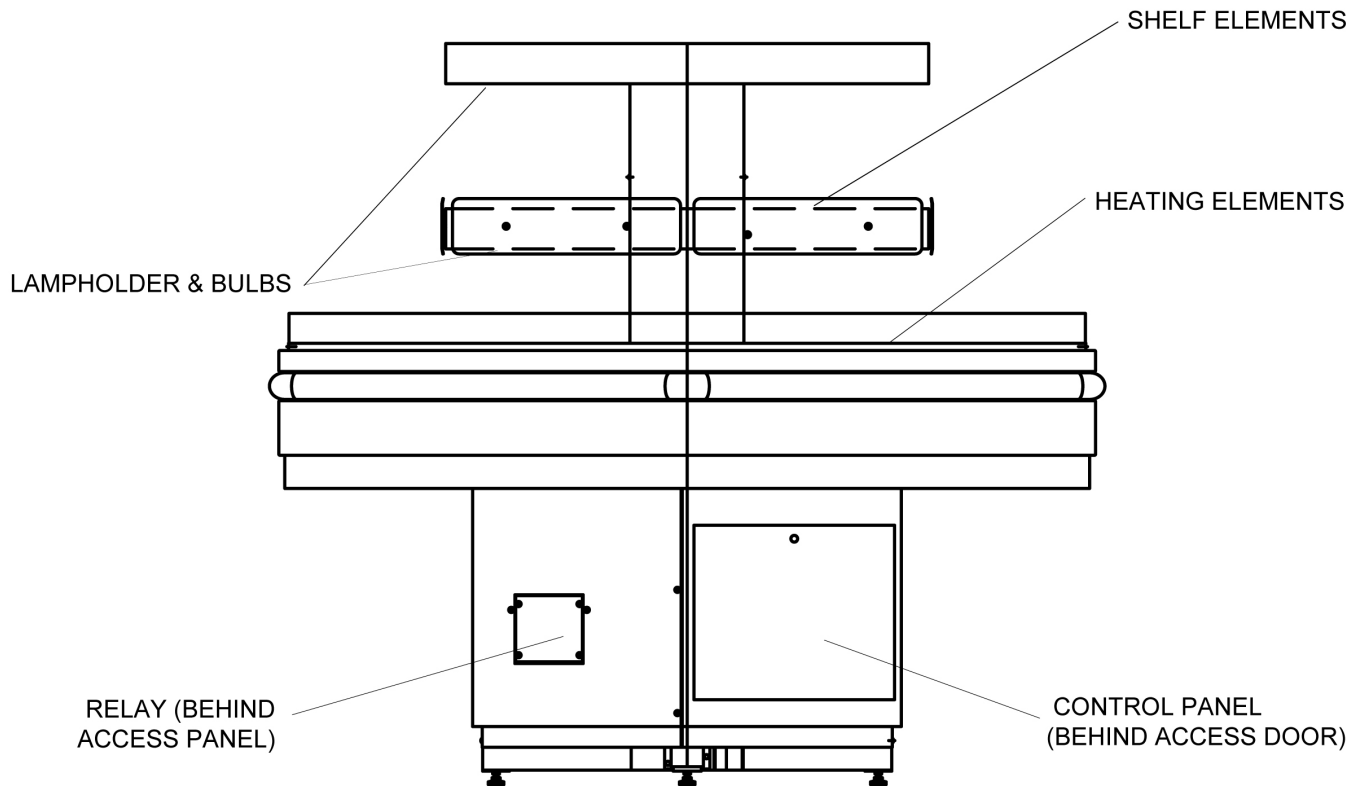

PART #	DESCRIPTION
B0555	BULB, 150W 240V HALOGEN COATED
LH0021	LAMPHOLDER, HI TEMP
C0766	HEATING ELEMENT, LOWER DECK, BHI-4, 208V
C0767	HEATING ELEMENT, LOWER DECK, BHI-4, 230V
C0751	HEATING ELEMENT, LOWER DECK, BHI-5, 208V
C0754	HEATING ELEMENT, LOWER DECK, BHI-5, 230V
C0753	HEATING ELEMENT, UPPER DECK, BHI-4 & 5, 208V
C0091	HEATING ELEMENT, UPPER DECK, BHI-4 & 5, 230V
B0090	BALLAST – 120V-277V, .28A
FL0047	FLUORESCENT BULB, T5, 14W W/ SHATTER SHIELD
CONTROL PANEL	
FH0001	FUSE HOLDER, 15A 300V
F0097	FUSE, 15A 300V TYPE G
PL004	PILOT LIGHT, 250V, 10W
S0006	MAIN SWITCH, 600V, 30A
S0141	INFINITE SWITCH, 240V 13A
K0040	KNOB

Wiring Diagrams

Refer to the table below to find the wiring diagram associated with your unit.

Wiring Diagram	Part No.	Page No.
BHI-5 208V-240V/1 Ph, Fluorescent Lights	SB71190000	Error! Bookmark not defined.
BHI-5T 208V-240V/1 Ph, Fluorescent Lights	SB71190100	15
BHI-5 208V/1 Ph, Quartz Halogen Lights	SB71190200	16
BHI-5 208V-240V/1 Ph, Fluorescent Lights, Canopy Wiring Option	SB71190800	17
BHI-5T 208V-240V/1 Ph, Fluorescent Lights, Canopy Wiring Option	SB71190900	18
BHI-4 208V-240V/1 Ph, Fluorescent Lights, Canopy Wiring Option	SB71191000	19
BHI-4T 208V-240V/1 Ph, Fluorescent Lights, Canopy Wiring Option	SB71191100	20

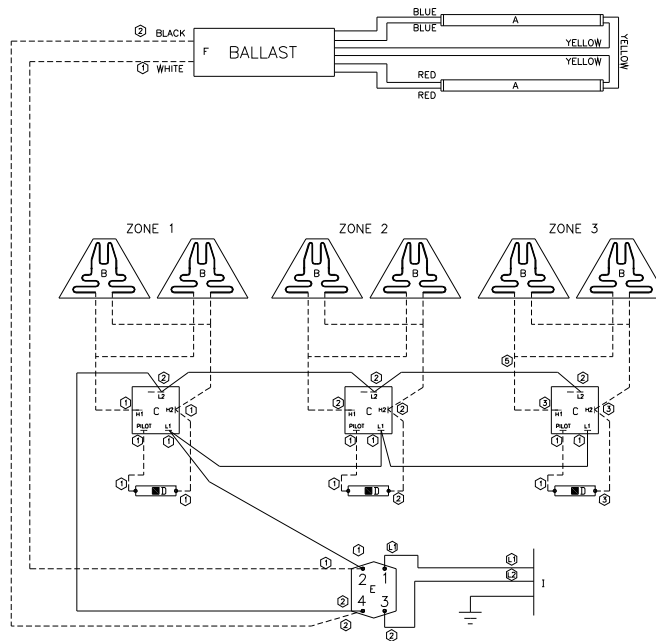

- A. FLOURESCENT BULBS- TS 4W COATED - FL0047
- B. FOIL ELEMENT (BASE)- 208V 400W - C0751
230V 400W - C0754
- C. INFINITE SWITCH- 240V 13A - S0141
- D. PILOT LIGHT- 10W 250V - PL0004
- E. ON/OFF SWITCH- 600V 30A - S0006
- F. BALLAST- 120-277V 0.28A - B0090

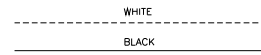

CONSULT UNIT RATING TAG PRIOR TO ELECTRICAL CONNECTION

APPROVED BY R/JN	DATE 2/28/06	MODEL No. BHI	VOLTAGE 240	PHASE 1	No. OF WIRES 2	AMPS. 11.0	KILOWATTS 2.6	BREAKER SIZE 20
APPROVED BY R/JN	DATE 2/28/06	MODEL No. BHI	VOLTAGE 208	PHASE 1	No. OF WIRES 2	AMPS. 11.6	KILOWATTS 2.4	BREAKER SIZE 20

NOTICE:
THE COMBINATION OF FACTS, DATA, DESIGN ELEMENTS,
ENGINEERING DATA, MANUFACTURING DATA AND
ASSEMBLY DATA WHICH MAY BE CONTAINED IN THIS
DRAWING ARE NOT TO BE USED OR COPIED
WITHOUT WRITTEN PERMISSION FROM BKH. ALL
RIGHTS ARE RESERVED.

REV. No. 06-060 6/23/06

BKI

TYPE/SIZE: DRAWING No.
S, B, SB7119000 1 of 1

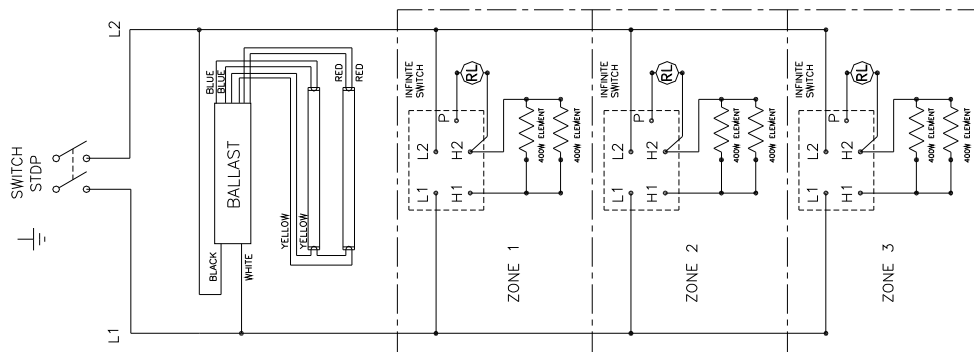

NOTE: DIAGRAM FOR BHI WITH FLORESCENT LIGHTS & FOIL HEAT

APPROVED BY R/JN	DATE 2/2/06	MODEL No. BHI	VOLTAGE 240	PHASE 1	No. OF WIRES 2	AMPS. 11.0	KILOWATTS 2.6	BREAKER SIZE 20
APPROVED BY R/JN	DATE 2/2/06	MODEL No. BHI	VOLTAGE 208	PHASE 1	No. OF WIRES 2	AMPS. 11.6	KILOWATTS 2.4	BREAKER SIZE 20

CONSULT UNIT RATING TAG PRIOR TO ELECTRICAL CONNECTION

NOTICE:
THE COMBINATION OF FACTS, DATA, DESIGN ELEMENTS,
ENGINEERING DATA, MANUFACTURING DATA AND
ASSEMBLY DATA WHICH MAY BE CONTAINED IN THIS
DRAWING ARE NOT TO BE USED OR COPIED
WITHOUT WRITTEN PERMISSION FROM BKH. ALL
RIGHTS ARE RESERVED.

REV. No.

BKI

TYPE/SIZE: DRAWING No.
S, B, SB711900 2 of 2

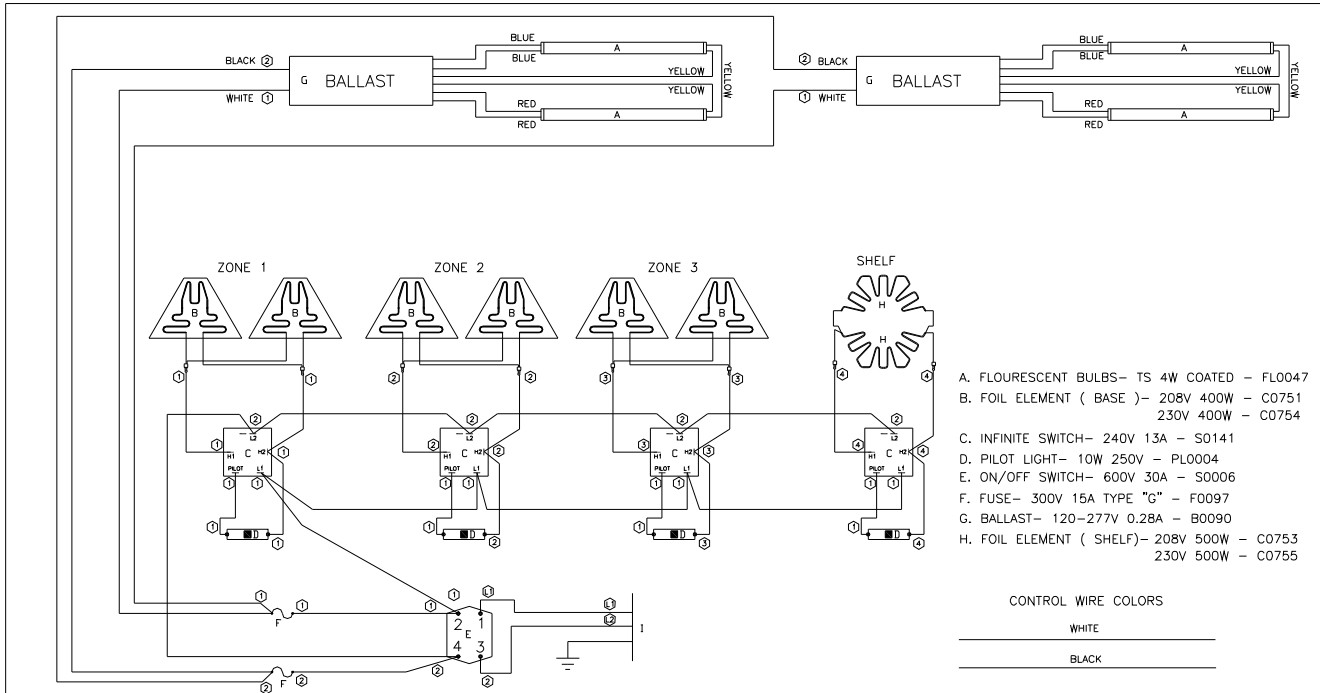

- A. FLOURESCENT BULBS- TS 4W COATED - FL0047
- B. FOIL ELEMENT (BASE)- 208V 400W - C0751
230V 400W - C0754
- C. INFINITE SWITCH- 240V 13A - S0141
- D. PILOT LIGHT- 10W 250V - PL0004
- E. ON/OFF SWITCH- 600V 30A - S0006
- F. FUSE- 300V 15A TYPE "G" - F0097
- G. BALLAST- 120-277V 0.28A - B0090
- H. FOIL ELEMENT (SHELF)- 208V 500W - C0753
230V 500W - C0755

CONTROL WIRE COLORS
 _____ WHITE
 _____ BLACK

APPROVED BY	DATE	MODEL No.	VOLTAGE	PHASE	No. OF WIRES	AMPS.	KILOWATTS	BREAKER SIZE	CONSULT UNIT RATING TAG PRIOR TO ELECTRICAL CONNECTION
RJN	2/28/06	BHI-T	240	1	2	15.8	3.75	25	NOTICE: THE COMBINATION OF FACTS, DATA, DESIGN ELEMENTS, ENGINEERING DATA, MANUFACTURING DATA AND ASSEMBLY DATA WHICH MAY BE CONTAINED IN THIS DRAWING ARE OF A PROPRIETARY NATURE TO BGI. THESE MATERIALS ARE NOT TO BE REPRODUCED OR COPIED WITHOUT WRITTEN PERMISSION FROM BGI. ALL RIGHTS ARE RESERVED.
APPROVED BY	DATE	MODEL No.	VOLTAGE	PHASE	No. OF WIRES	AMPS.	KILOWATTS	BREAKER SIZE	
RJN	4/2/08	BHI-T	220	1	2	14.6	3.21	25	
APPROVED BY	DATE	MODEL No.	VOLTAGE	PHASE	No. OF WIRES	AMPS.	KILOWATTS	BREAKER SIZE	REV. No.
RJN	2/28/06	BHI-T	208	1	2	16.6	3.5	25	08-031 4/2/08 RJN



TYPE SIZE DRAWING No.
 S B 71190100 1 of 1

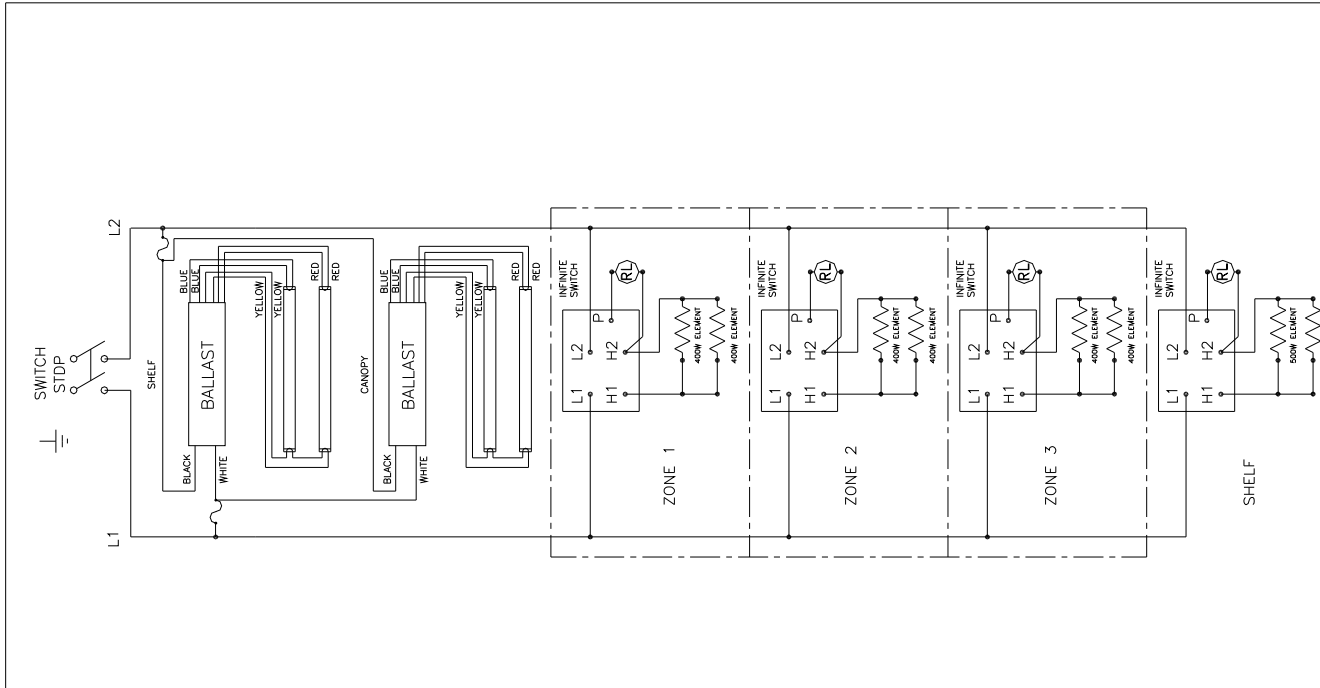

NOTE: DIAGRAM FOR BHI-T WITH FLORESCENT LIGHTS & FOIL HEAT

APPROVED BY	DATE	MODEL No.	VOLTAGE	PHASE	No. OF WIRES	AMPS.	KILOWATTS	BREAKER SIZE	CONSULT UNIT RATING TAG PRIOR TO ELECTRICAL CONNECTION
RJN	2/28/06	BHI-T	240	1	2	15.8	3.75	25	NOTICE: THE COMBINATION OF FACTS, DATA, DESIGN ELEMENTS, ENGINEERING DATA, MANUFACTURING DATA AND ASSEMBLY DATA WHICH MAY BE CONTAINED IN THIS DRAWING ARE OF A PROPRIETARY NATURE TO BGI. THESE MATERIALS ARE NOT TO BE REPRODUCED OR COPIED WITHOUT WRITTEN PERMISSION FROM BGI. ALL RIGHTS ARE RESERVED.
APPROVED BY	DATE	MODEL No.	VOLTAGE	PHASE	No. OF WIRES	AMPS.	KILOWATTS	BREAKER SIZE	
RJN	4/2/08	BHI-T	220	1	2	14.6	3.21	25	
APPROVED BY	DATE	MODEL No.	VOLTAGE	PHASE	No. OF WIRES	AMPS.	KILOWATTS	BREAKER SIZE	REV. No.
RJN	2/28/06	BHI-T	208	1	2	16.6	3.5	25	08-031 4/2/08 RJN



TYPE SIZE DRAWING No.
 S B 71190100 1 of 1

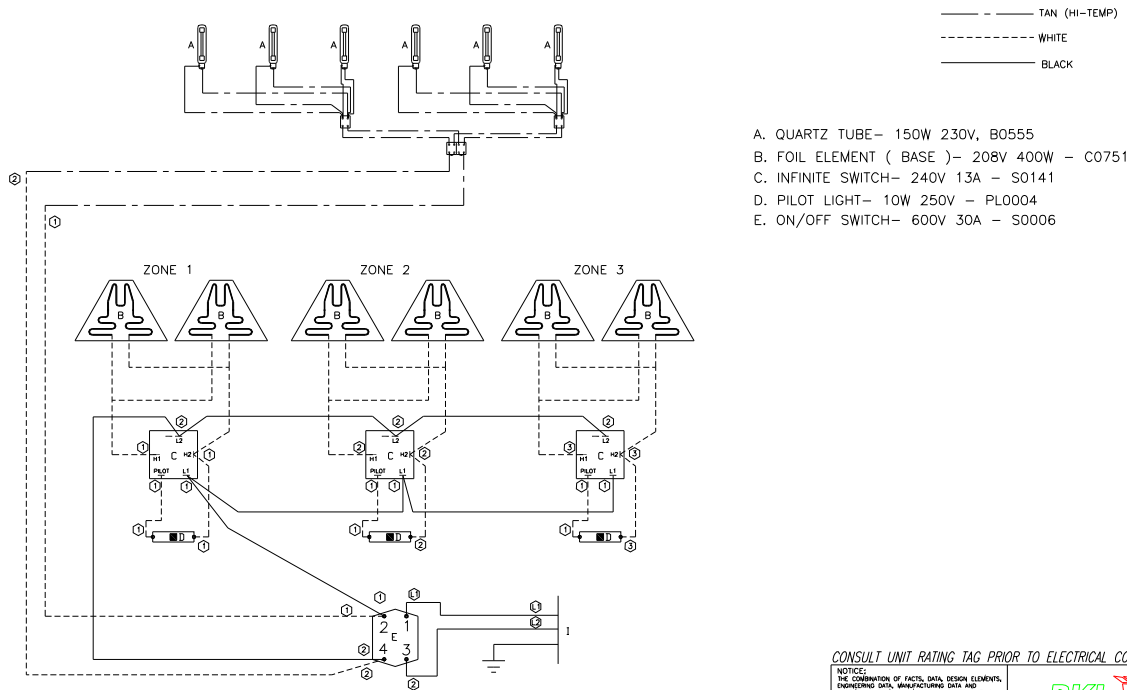

CONSULT UNIT RATING TAG PRIOR TO ELECTRICAL CONNECTION

NOTICE:
 THE COMBINATION OF FACTS, DATA, DESIGN ELEMENTS,
 ENGINEERING DATA, MANUFACTURING DATA AND
 ASSEMBLY DATA WHICH MAY BE CONTAINED IN THIS
 DRAWING ARE OF A PROPRIETARY NATURE TO BKL.
 THESE DRAWINGS ARE NOT TO BE USED OR COPIED
 WITHOUT PRIOR WRITTEN PERMISSION FROM BKL. ALL
 RIGHTS ARE RESERVED.



APPROVED BY	DATE	MODEL No.	VOLTAGE	PHASE	No. OF WIRES	AMPS.	KILOWATTS	BREAKER SIZE	REV. No.	TYPE SIZE	DRAWING No.
RJN	2/28/06	BHI	208	1	2	15.1	3.1	20	06-091 9/22/06	S ₁ B ₁	711902

1 of 2

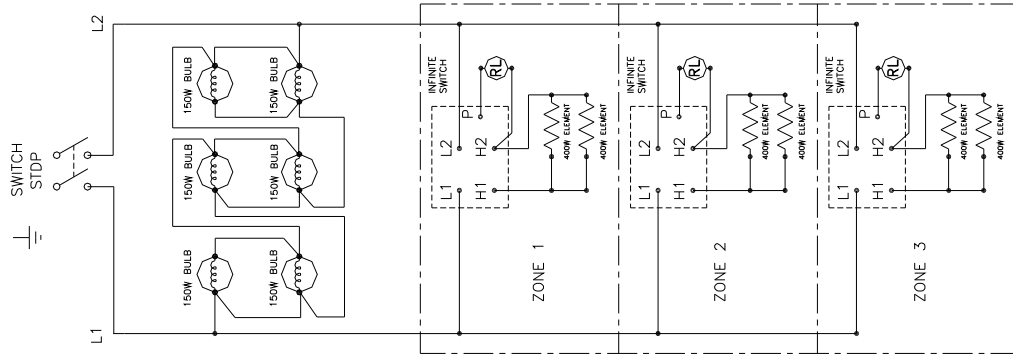

CONSULT UNIT RATING TAG PRIOR TO ELECTRICAL CONNECTION

NOTICE:
 THE COMBINATION OF FACTS, DATA, DESIGN ELEMENTS,
 ENGINEERING DATA, MANUFACTURING DATA AND
 ASSEMBLY DATA WHICH MAY BE CONTAINED IN THIS
 DRAWING ARE OF A PROPRIETARY NATURE TO BKL.
 THESE DRAWINGS ARE NOT TO BE USED OR COPIED
 WITHOUT PRIOR WRITTEN PERMISSION FROM BKL. ALL
 RIGHTS ARE RESERVED.



NOTE: DIAGRAM FOR BHI WITH 150W LIGHTS & FOIL HEAT

APPROVED BY	DATE	MODEL No.	VOLTAGE	PHASE	No. OF WIRES	AMPS.	KILOWATTS	BREAKER SIZE	REV. No.	TYPE SIZE	DRAWING No.
RJN	2/3/06	BHI	208	1	2	15.1	3.1	20		S ₁ B ₁	SB711902

2 of 2

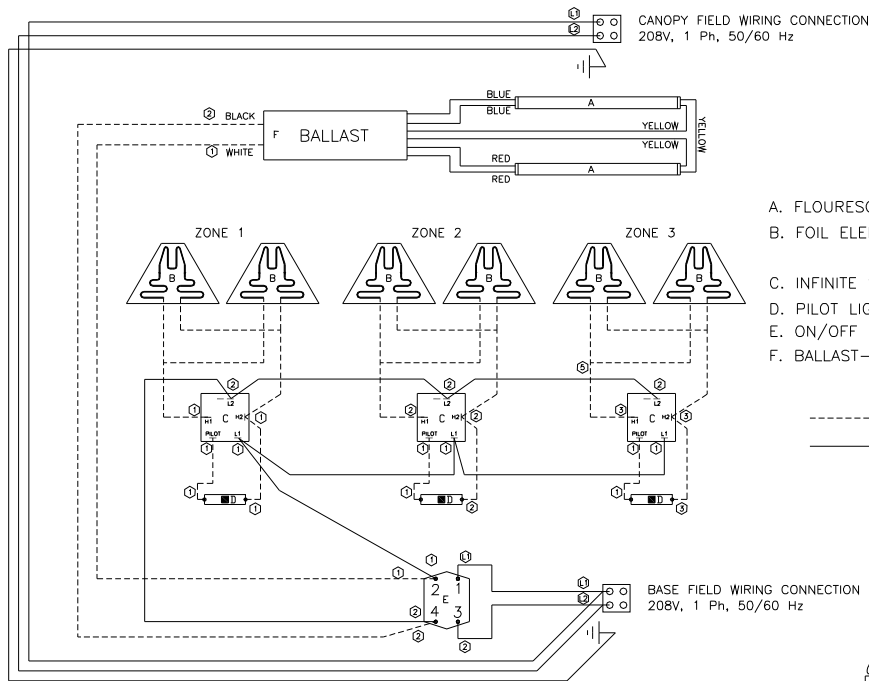

- A. FLOURESCENT BULBS- TS 4W COATED - FLO047
- B. FOIL ELEMENT (BASE)- 208V 250W - C0751
230V 250W - C0754
- C. INFINITE SWITCH- 240V 13A - S0141
- D. PILOT LIGHT- 10W 250V - PLO004
- E. ON/OFF SWITCH- 600V 30A - S0006
- F. BALLAST- 120-277V 0.28A - B0090

----- WHITE
 _____ BLACK

CONSULT UNIT RATING TAG PRIOR TO ELECTRICAL CONNECTION

APPROVED BY	DATE	MODEL No.	VOLTAGE	PHASE	No. OF WIRES	AMPS.	KILOWATTS	BREAKER SIZE	REV. No.	TYPE/SIZE	DRAWING No.
TAH	10/15/13	BHI-5	240	1	2	11.0	2.6	20	10/15/13	13-105	S, B, 71190800
APPROVED BY	DATE	MODEL No.	VOLTAGE	PHASE	No. OF WIRES	AMPS.	KILOWATTS	BREAKER SIZE			
		BHI-5	208	1	2	11.6	2.4	20			

NOTICE:
 THE COMBINATION OF FACTS, DATA, DESIGN ELEMENTS,
 ENGINEERING DATA, MANUFACTURING DATA AND
 OTHERWISE DATA WHICH MAY BE CONTAINED IN THIS
 DRAWING ARE OF A PROPRIETARY NATURE TO BKH.
 THESE MATERIALS ARE NOT TO BE USED OR COPIED
 WITHOUT PRIOR WRITTEN PERMISSION FROM BKH. ALL
 RIGHTS ARE RESERVED.

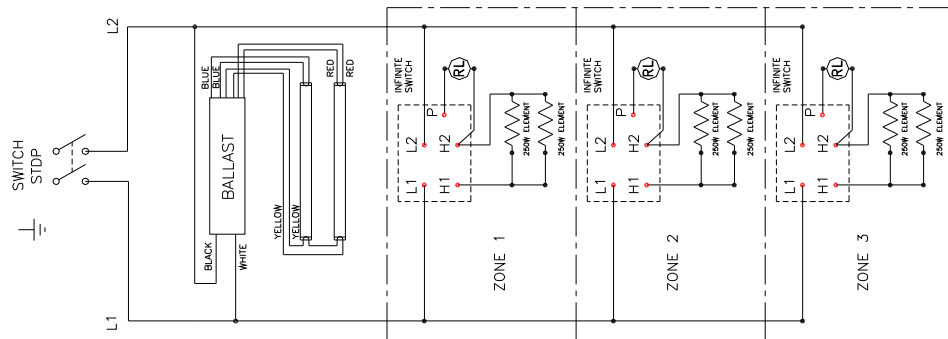

NOTE: DIAGRAM FOR BHI WITH FLORESCENT LIGHTS & FOIL HEAT

CONSULT UNIT RATING TAG PRIOR TO ELECTRICAL CONNECTION

APPROVED BY	DATE	MODEL No.	VOLTAGE	PHASE	No. OF WIRES	AMPS.	KILOWATTS	BREAKER SIZE	REV. No.	TYPE/SIZE	DRAWING No.
TAH	10/15/13	BHI-5	240	1	2	11.0	2.6	20	10/15/13	13-105	S, B, 71190800
APPROVED BY	DATE	MODEL No.	VOLTAGE	PHASE	No. OF WIRES	AMPS.	KILOWATTS	BREAKER SIZE			
		BHI-5	208	1	2	11.6	2.4	20			

NOTICE:
 THE COMBINATION OF FACTS, DATA, DESIGN ELEMENTS,
 ENGINEERING DATA, MANUFACTURING DATA AND
 OTHERWISE DATA WHICH MAY BE CONTAINED IN THIS
 DRAWING ARE OF A PROPRIETARY NATURE TO BKH.
 THESE MATERIALS ARE NOT TO BE USED OR COPIED
 WITHOUT PRIOR WRITTEN PERMISSION FROM BKH. ALL
 RIGHTS ARE RESERVED.



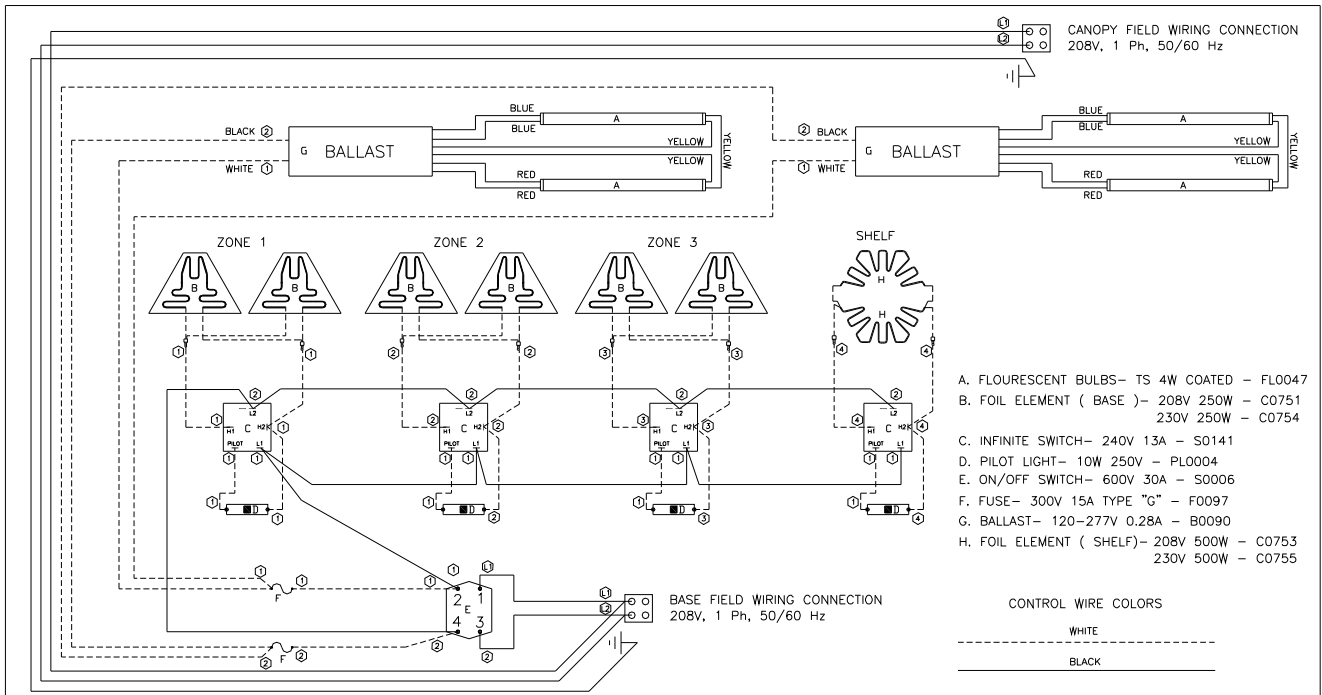

APPROVED BY	DATE	MODEL No.	VOLTAGE	PHASE	No. OF WIRES	AMPS.	KILOWATTS	BREAKER SIZE	CONSULT UNIT RATING TAG PRIOR TO ELECTRICAL CONNECTION
TAH	10/15/13	BH15-T	240	1	2	15.8	3.8	25	NOTICE: THE COMBINATION OF FACTS, DATA, DESIGN ELEMENTS, ENGINEERING DATA, MANUFACTURING DATA AND ASSEMBLY DATA WHICH MAY BE CONTAINED IN THIS DRAWING ARE OF A PROPRIETARY NATURE TO BGI. THESE MATERIALS ARE NOT TO BE COPIED OR REPRODUCED WITHOUT PRIOR WRITTEN PERMISSION FROM BGI. ALL RIGHTS ARE RESERVED.
APPROVED BY	DATE	MODEL No.	VOLTAGE	PHASE	No. OF WIRES	AMPS.	KILOWATTS	BREAKER SIZE	
		BH15-T	220	1	2	14.6	3.2	25	
APPROVED BY	DATE	MODEL No.	VOLTAGE	PHASE	No. OF WIRES	AMPS.	KILOWATTS	BREAKER SIZE	REV. No.
		BH15-T	208	1	2	16.6	3.5	25	10/15/13 13-105

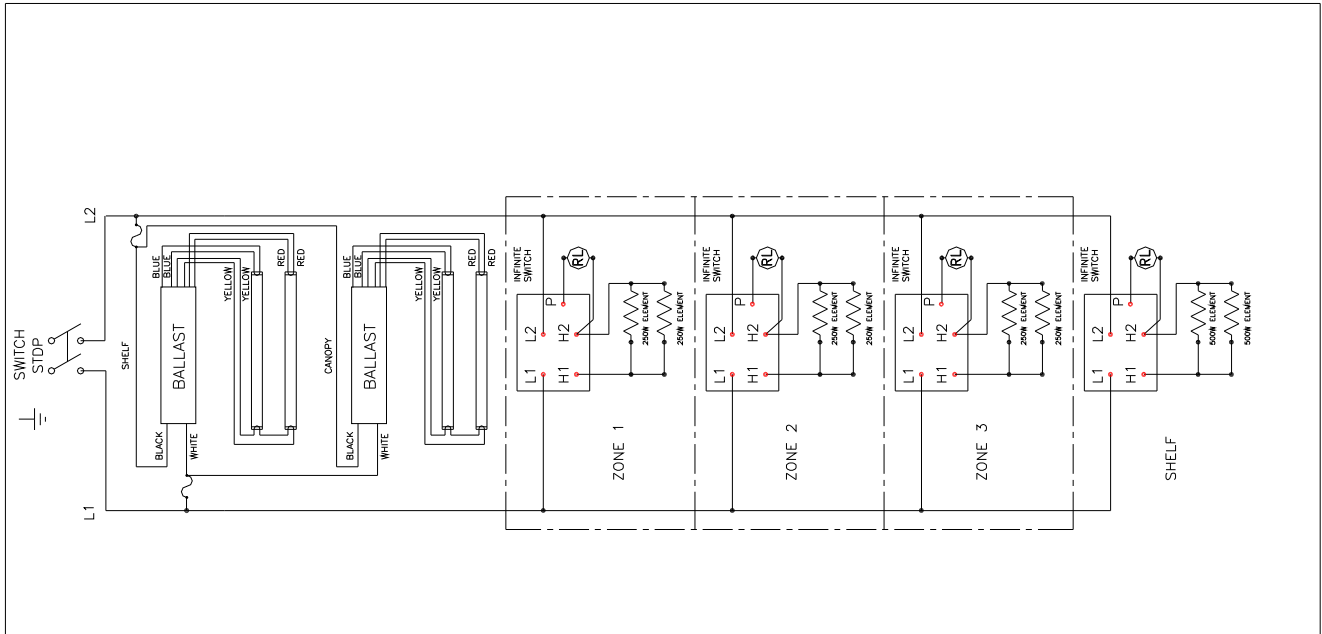

NOTE: DIAGRAM FOR BH1-T WITH FLORESCENT LIGHTS & FOIL HEAT

APPROVED BY	DATE	MODEL No.	VOLTAGE	PHASE	No. OF WIRES	AMPS.	KILOWATTS	BREAKER SIZE	CONSULT UNIT RATING TAG PRIOR TO ELECTRICAL CONNECTION
TAH	10/15/13	BH15-T	240	1	2	15.8	3.8	25	NOTICE: THE COMBINATION OF FACTS, DATA, DESIGN ELEMENTS, ENGINEERING DATA, MANUFACTURING DATA AND ASSEMBLY DATA WHICH MAY BE CONTAINED IN THIS DRAWING ARE OF A PROPRIETARY NATURE TO BGI. THESE MATERIALS ARE NOT TO BE COPIED OR REPRODUCED WITHOUT PRIOR WRITTEN PERMISSION FROM BGI. ALL RIGHTS ARE RESERVED.
APPROVED BY	DATE	MODEL No.	VOLTAGE	PHASE	No. OF WIRES	AMPS.	KILOWATTS	BREAKER SIZE	
		BH15-T	220	1	2	14.6	3.2	25	
APPROVED BY	DATE	MODEL No.	VOLTAGE	PHASE	No. OF WIRES	AMPS.	KILOWATTS	BREAKER SIZE	REV. No.
		BH15-T	208	1	2	16.6	3.5	25	10/15/13 13-105

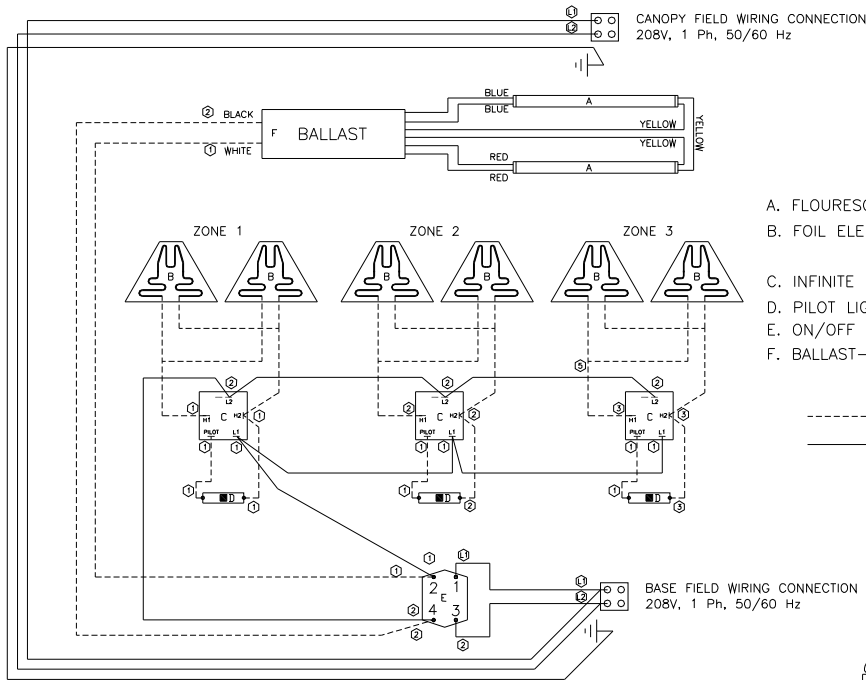

- A. FLOURESCENT BULBS- TS 4W COATED - FLO047
- B. FOIL ELEMENT (BASE)- 208V 250W - C0766
230V 250W - C0767
- C. INFINITE SWITCH- 240V 13A - S0141
- D. PILOT LIGHT- 10W 250V - PL0004
- E. ON/OFF SWITCH- 600V 30A - S0006
- F. BALLAST- 120-277V 0.28A - B0090

----- WHITE
 _____ BLACK

CONSULT UNIT RATING TAG PRIOR TO ELECTRICAL CONNECTION

APPROVED BY TAH	DATE 9/18/13	MODEL No. BHI-4	VOLTAGE 240	PHASE 1	No. OF WIRES 2	AMPS. 7.5	KILOWATTS 1.8	BREAKER SIZE 10
APPROVED BY	DATE	MODEL No.	VOLTAGE	PHASE	No. OF WIRES	AMPS.	KILOWATTS	BREAKER SIZE
		BHI-4	208	1	2	7.9	1.7	10

NOTICE:
 THE COMBINATION OF FACTS, DATA, DESIGN ELEMENTS,
 ENGINEERING DATA, MANUFACTURING DATA AND
 ASSEMBLY DATA WHICH MAY BE CONTAINED IN THIS
 DRAWING ARE NOT TO BE REPRODUCED OR COPIED
 WITHOUT PRIOR WRITTEN PERMISSION FROM BKI. ALL
 RIGHTS ARE RESERVED.

REV. No. 9/18/13 13-096



TYPE SIZE DRAWING No.
 S_B 71191000 1 of 2

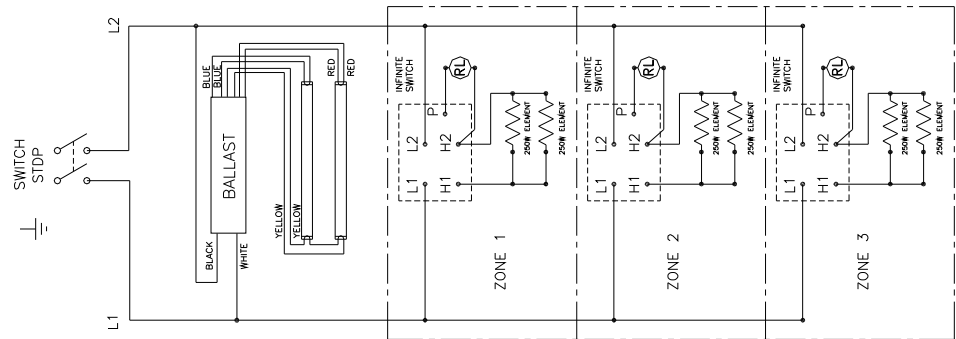

NOTE: DIAGRAM FOR BHI WITH FLORESCENT LIGHTS & FOIL HEAT

CONSULT UNIT RATING TAG PRIOR TO ELECTRICAL CONNECTION

APPROVED BY TAH	DATE 9/18/13	MODEL No. BHI-4	VOLTAGE 240	PHASE 1	No. OF WIRES 2	AMPS. 7.5	KILOWATTS 1.8	BREAKER SIZE 10
APPROVED BY	DATE	MODEL No.	VOLTAGE	PHASE	No. OF WIRES	AMPS.	KILOWATTS	BREAKER SIZE
		BHI-4	208	1	2	7.9	1.7	10

NOTICE:
 THE COMBINATION OF FACTS, DATA, DESIGN ELEMENTS,
 ENGINEERING DATA, MANUFACTURING DATA AND
 ASSEMBLY DATA WHICH MAY BE CONTAINED IN THIS
 DRAWING ARE NOT TO BE REPRODUCED OR COPIED
 WITHOUT PRIOR WRITTEN PERMISSION FROM BKI. ALL
 RIGHTS ARE RESERVED.

REV. No. 9/18/13 13-096



TYPE SIZE DRAWING No.
 S_B 71191000 2 of 2

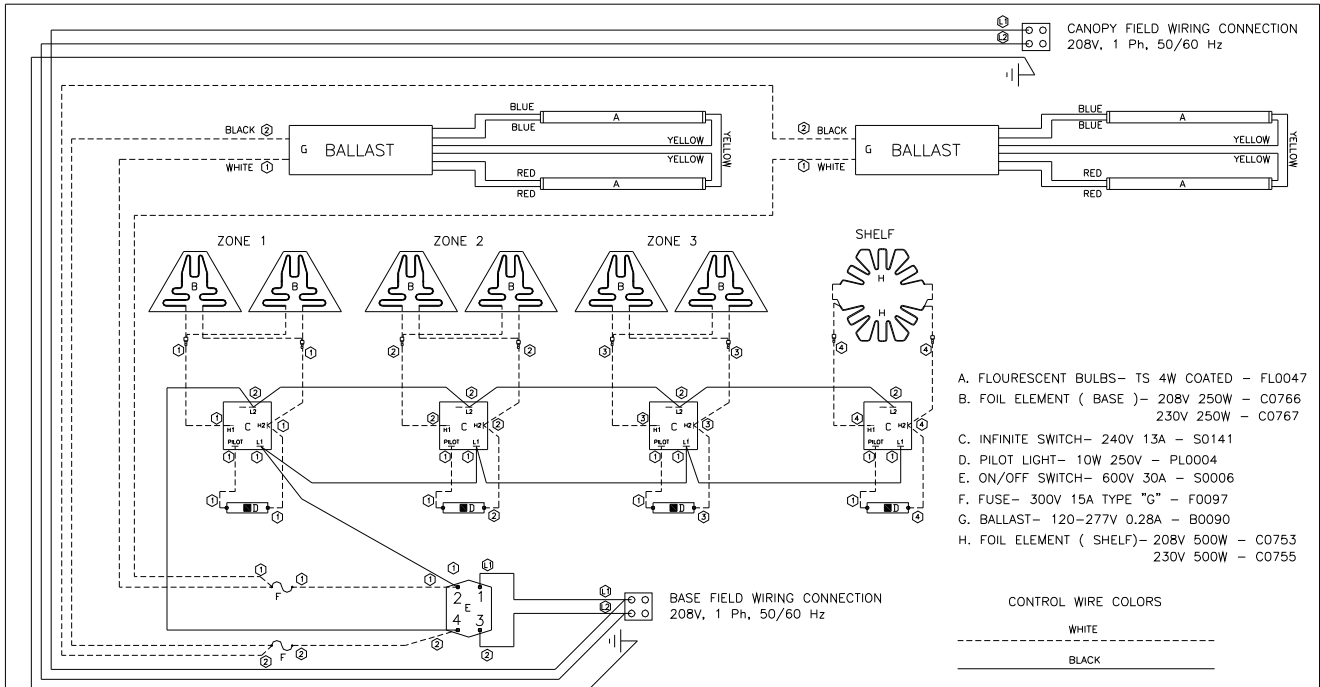

APPROVED BY	DATE	MODEL No.	VOLTAGE	PHASE	No. OF WIRES	AMPS.	KILOWATTS	BREAKER SIZE	CONSULT UNIT RATING TAG PRIOR TO ELECTRICAL CONNECTION		
TAH	9/19/13	BH14-T	240	1	2	12.0	2.9	15	NOTICE: THE COMBINATION OF FACTS, DATA, DESIGN ELEMENTS, ENGINEERING DATA, MANUFACTURING DATA AND ASSEMBLY DATA WHICH MAY BE CONTAINED IN THIS DRAWING ARE OF A PROPRIETARY NATURE TO BAKI. THESE DRAWINGS ARE NOT TO BE USED OR COPIED WITHOUT PRIOR WRITTEN PERMISSION FROM BAKI. ALL RIGHTS ARE RESERVED.		
APPROVED BY	DATE	MODEL No.	VOLTAGE	PHASE	No. OF WIRES	AMPS.	KILOWATTS	BREAKER SIZE			
		BH14-T	220	1	2	11.0	2.4	15			
APPROVED BY	DATE	MODEL No.	VOLTAGE	PHASE	No. OF WIRES	AMPS.	KILOWATTS	BREAKER SIZE	REV. No.	TYPE SIZE	DRAWING No.
		BH14-T	208	1	2	12.7	2.7	20	09/19/13	13-096	S, B, 71191100

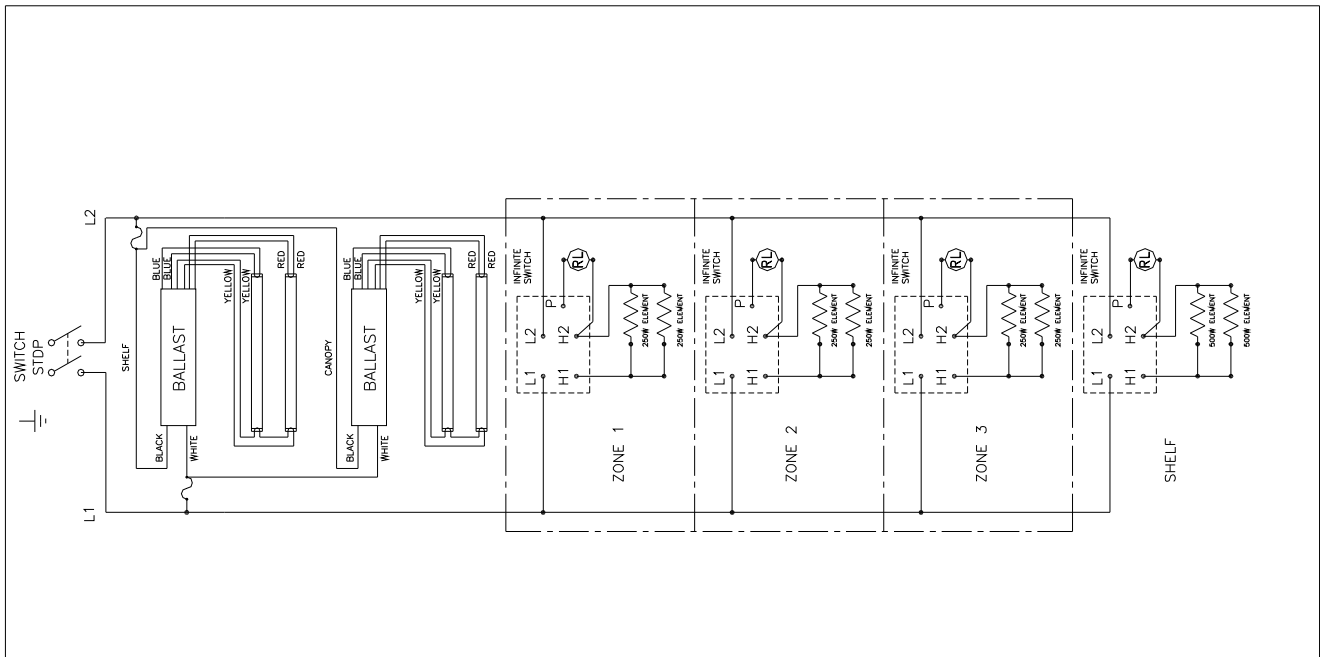

NOTE: DIAGRAM FOR BH1-T WITH FLORESCENT LIGHTS & FOIL HEAT

APPROVED BY	DATE	MODEL No.	VOLTAGE	PHASE	No. OF WIRES	AMPS.	KILOWATTS	BREAKER SIZE	CONSULT UNIT RATING TAG PRIOR TO ELECTRICAL CONNECTION		
TAH	9/19/13	BH14-T	240	1	2	12.0	2.9	15	NOTICE: THE COMBINATION OF FACTS, DATA, DESIGN ELEMENTS, ENGINEERING DATA, MANUFACTURING DATA AND ASSEMBLY DATA WHICH MAY BE CONTAINED IN THIS DRAWING ARE OF A PROPRIETARY NATURE TO BAKI. THESE DRAWINGS ARE NOT TO BE USED OR COPIED WITHOUT PRIOR WRITTEN PERMISSION FROM BAKI. ALL RIGHTS ARE RESERVED.		
APPROVED BY	DATE	MODEL No.	VOLTAGE	PHASE	No. OF WIRES	AMPS.	KILOWATTS	BREAKER SIZE			
		BH14-T	220	1	2	11.0	2.4	15			
APPROVED BY	DATE	MODEL No.	VOLTAGE	PHASE	No. OF WIRES	AMPS.	KILOWATTS	BREAKER SIZE	REV. No.	TYPE SIZE	DRAWING No.
		BH14-T	208	1	2	12.7	2.7	20	09/19/13	13-096	S, B, 71191100

Notes



2812 Grandview Dr., Simpsonville, S.C. 29680, USA
<http://www.bkideas.com>

Made and printed in the U.S.A