



Innovative Foodservice Equipment Custom
Designed for Performance, Service and Value.

INSTALLATION AND OPERATING INSTRUCTIONS

Hot Holding Cabinet

Model: CS72 - CH13

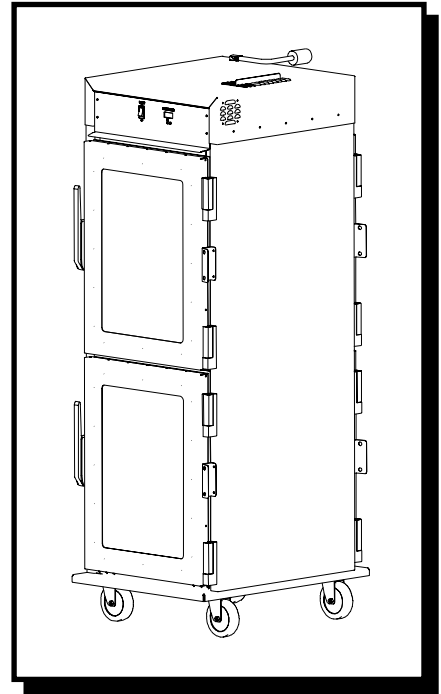

INTENDED FOR OTHER THAN HOUSEHOLD USE
RETAIN THIS MANUAL FOR FUTURE REFERENCE
UNIT MUST BE KEPT CLEAR OF COMBUSTIBLES AT ALL TIMES



FOR YOUR SAFETY

Do not store or use gasoline or other flammable vapors and liquids in the vicinity of this or any other appliance.



WARNING

Improper installation, adjustment, alteration, service or maintenance can cause property damage, injury or death. Read the Installation, Operating and Maintenance Instructions thoroughly before installing or servicing this equipment.



WARNING

Initial heating of unit may generate smoke or fumes and must be done in a well-ventilated area. Overexposure to smoke or fumes may cause nausea or dizziness.



This equipment has been engineered to provide you with year round dependable service when used according to the instructions in this manual and standard commercial kitchen practices.



ANSI/NSF 4

P/N 8817600 9/04

Phone: +1 (214) 421-7366
Fax: +1 (214) 565-0976
Toll Free: +1 (800) 441-1601
Website: www.BevLes.com
E-mail: sales@BevLes.com

BevLes
729 Third Avenue
Dallas, TX 75226









The **Bevles Company** takes pride in the design and quality of our products. When used as intended and with proper care and maintenance, you will experience years of reliable operation from this equipment. To ensure best results, it is important that you read and follow the instructions in this manual carefully. Installation and start-up should be performed by a qualified installer who thoroughly read, understands and follows these instruction.

If you have questions concerning the installation, operation, maintenance or service of this product, write Technical Service Department Bevles Company, Inc., P.O. Box 965, Chino, CA 91710.

SAFETY PRECAUTIONS













Before installing and operating this equipment be sure everyone involved in its operation are fully trained and are aware of all precautions. Accidents and problems can result by a failure to follow fundamental rules and precautions.















The following words and symbols, found in this manual, alert you to hazards to the operator, service personnel or the equipment. The words are defined as follows:

-  **DANGER:** This symbol warns of imminent hazard which will result in serious injury or death. 
-  **WARNING:** This symbol refers to a potential hazard or unsafe practice, which could result in serious injury or death. 
-  **CAUTION:** This symbol refers to a potential hazard or unsafe practice, which may result in minor or moderate injury or product or property damage. 
-  **NOTICE:** This symbol refers to information that needs special attention or must be fully understood even though not dangerous. 

GENERAL INFORMATION

THIS MANUAL SHOULD BE RETAINED FOR FUTURE REFERENCE

-  **CAUTION:** These models are designed, built, and sold for commercial use. If these models are positioned so the general public can use the equipment make sure that cautions, warnings, and operating instructions are clearly posted near each unit so that anyone using the equipment will use it correctly and not injure themselves or harm the equipment. 
-  **WARNING:** Check the data plate on this unit before installation. Connect the unit only to the voltage and frequency listed on the data plate. Connect only to 1 or 3 phase as listed on the data plate. 
-  **WARNING:** Electrical and grounding connections must comply with the applicable portions of the national electrical code and/or other local electrical codes. 
-  **WARNING:** Disconnect device from electrical power supply and place a Tag Out-Lockout on the power plug, indicating that you are working on the circuit. 
-  **WARNING:** Install per the spacing requirements listed in the installation section of this manual. We strongly recommend having a competent professional install the equipment. A licensed electrician should make the electrical connections and connect power to the unit. Local codes should always be used when connecting these units to electrical power. In the absence of local codes, use the latest version of the National Electrical Code. 
-  **WARNING:** This device should be safely and adequately grounded in accordance with local codes, or in the absence of local codes, with the National Electrical code, ANSI/NFPA 70, Latest Edition to protect the user from electrical shock. It requires a grounded system and a dedicated circuit, protected by a fuse or circuit breaker of proper size and rating. Canadian installation must comply with the Canadian Electrical Code, CSAC22.2, as applicable 

	WARNING: Never clean any electrical unit by immersing it in water. Turn off before cleaning surface.	
	WARNING: An earthing cable must connect the appliance to all other units in the complete installation and from there to an independent earth connection.	
	NOTICE: The unit when installed, must be electrically grounded and comply with local codes, or in the absence of local codes, with the national electrical code ANSI/NFPA70- latest edition. Canadian installation must comply with CSA-STANDARD C.22.2 Number 0 M1982 General Requirements-Canadian Electrical Code Part II, 109-M1981- Commercial Cooking Appliances.	
	WARNING: SHOCK HAZARD - De-energize all power to equipment before cleaning the equipment.	
	NOTICE: This product is intended for commercial use only. Not for household use.	
	NOTICE: Local codes regarding installation vary greatly from one area to another. The National Fire Protection Association, Inc. states in its NFPA96 latest edition that local codes are "Authority Having Jurisdiction" when it comes to requirement for installation of equipment. Therefore, installation should comply with all local codes.	
	WARNING: SHOCK HAZARD - Do not open any panels that require the use of tools.	

IMMEDIATELY INSPECT FOR SHIPPING DAMAGE

All containers should be examined for damage before and during unloading. The freight carrier has assumed responsibility for its safe transit and delivery. If equipment is received damaged, either apparent or concealed, a claim must be made with the delivering carrier.

- A) Apparent damage or loss must be noted on the freight bill at the time of delivery. It must then be signed by the carrier representative (Driver). If this is not done, the carrier may refuse the claim. The carrier can supply the necessary forms.
- B) Concealed damage or loss if not apparent until after equipment is uncrated, a request for inspection must be made to the carrier within 15 days. The carrier should arrange an inspection. Be certain to hold all contents and packaging material.

Installation and start-up should be performed by a qualified installer who thoroughly read, understands and follows these instructions.

TABLE OF CONTENTS

SECTION	ITEM	PAGE
	Safety Precautions	2
	General Information	2
1	Introduction	4
2	Specifications	4
3	Installation	4
4	Operational Procedure	4
5	Cleaning	5
6	Wiring Diagram	6
7	Parts List & Exploded View	6
8	Warranty	8

1. INTRODUCTION

Bevles Hot Holding Cabinets are designed and engineered to hold prepared foods within a precise temperature range. Built from the finest materials available, Bevles Hot Holding Cabinets are custom designed for performance, service and value.

All personnel responsible for the operation and maintenance of Bevles Hot Holding Cabinets should become familiar with this manual prior to operating the equipment.

Notes

- ★ All models are U.L., C.U.L., and N.S.F. listed and approved.
- ★ Cabinet is furnished with an 8-foot power cord with a 20 amp twist locking plug. A NEMA L5-20R receptacle is required.
- ★ Cabinet is equipped with self-closing door hinges designed to open to a maximum of 180°, but a door stop plate has been installed to prevent doors from opening past 90°.
- ★ Hot Holding Cabinets require a minimum of 4" between the sides and top of the cabinet and other equipment or surfaces for proper air circulation to and from fan motor air vents.
Do not place any objects over motor air vents on right side of cabinet top.

2. SPECIFICATIONS

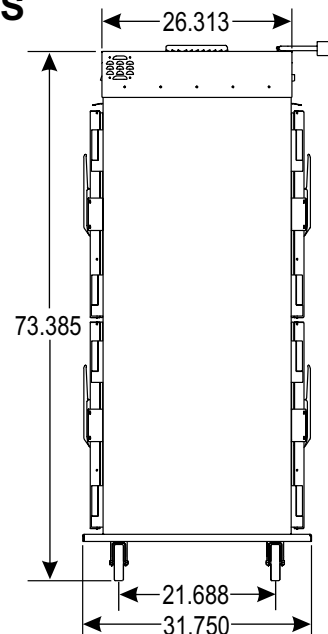
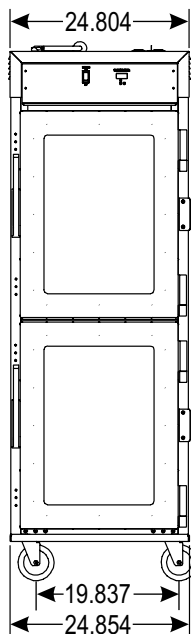

3. INSTALLATION

1. Remove all packing material and protective covering from cabinet.
2. Completely clean unit as described in the CLEANING section of this manual.
3. Move cabinet to desired operating location and lock two wheel brakes.
4. Plug the cabinet into the power source. Use a separate electrical line (120V-20A), protected by a circuit breaker of the proper rating.
WARNING: Before plugging in cabinet, ensure compatibility with your electrical source by referring to the serial number label located on the top side of the Hot Holding Cabinet. For any necessary assistance, please contact the Bevles factory.
5. Make certain that the airflow (side) panels are properly secured to the interior walls of the cabinet.

4. OPERATIONAL PROCEDURE

1. Push on the power switch. The digital display will light and show the current cabinet temperature. A red LED light (located in the upper left corner of the display) will be displayed anytime the cabinet temperature falls below the set temperature.

2. After five minutes, check the digital display and the air flow inside the cabinet to be sure that it is heating properly.
3. Allow the cabinet to preheat for 1 hour before placing product in cabinet.
NOTE: This unit has a maximum operating temperature of 185°F.

5. CLEANING

1. Push power switch to OFF position.
2. Unplug power cord from power source. **WARNING: Always unplug the cabinet before dismantling or cleaning.**
3. Open door(s) to 90° position.
4. If needed, remove the top mounted heating module. **CAUTION: At least two people should do the lifting to avoid possible injury.**
5. Remove the airflow (side) panels by carefully lifting each panel and tilting the bottom toward the center of the cabinet. **CAUTION: Use care when handling the airflow (side) panels. Any damage or bending may make re-installation difficult.**
6. Clean all parts thoroughly with soapy water and soft cloths or sponges. Never use steel wool or caustic cleaning compounds.

WARNING: Avoid splashing water or any other liquid into the top mounted heating module to prevent possible damage to electrical components.

IF YOU HAVE ANY QUESTIONS REGARDING THE INSTALLATION OR OPERATION OF YOUR BEVLES HOT HOLDING CABINET, REVIEW THIS MANUAL AND THEN CALL THE BEVLES FACTORY CUSTOMER SERVICE SUPPORT HOTLINE: **BEVLES 800/441-1601**

6. WIRING DIAGRAM

MODEL: CS72 - CH13

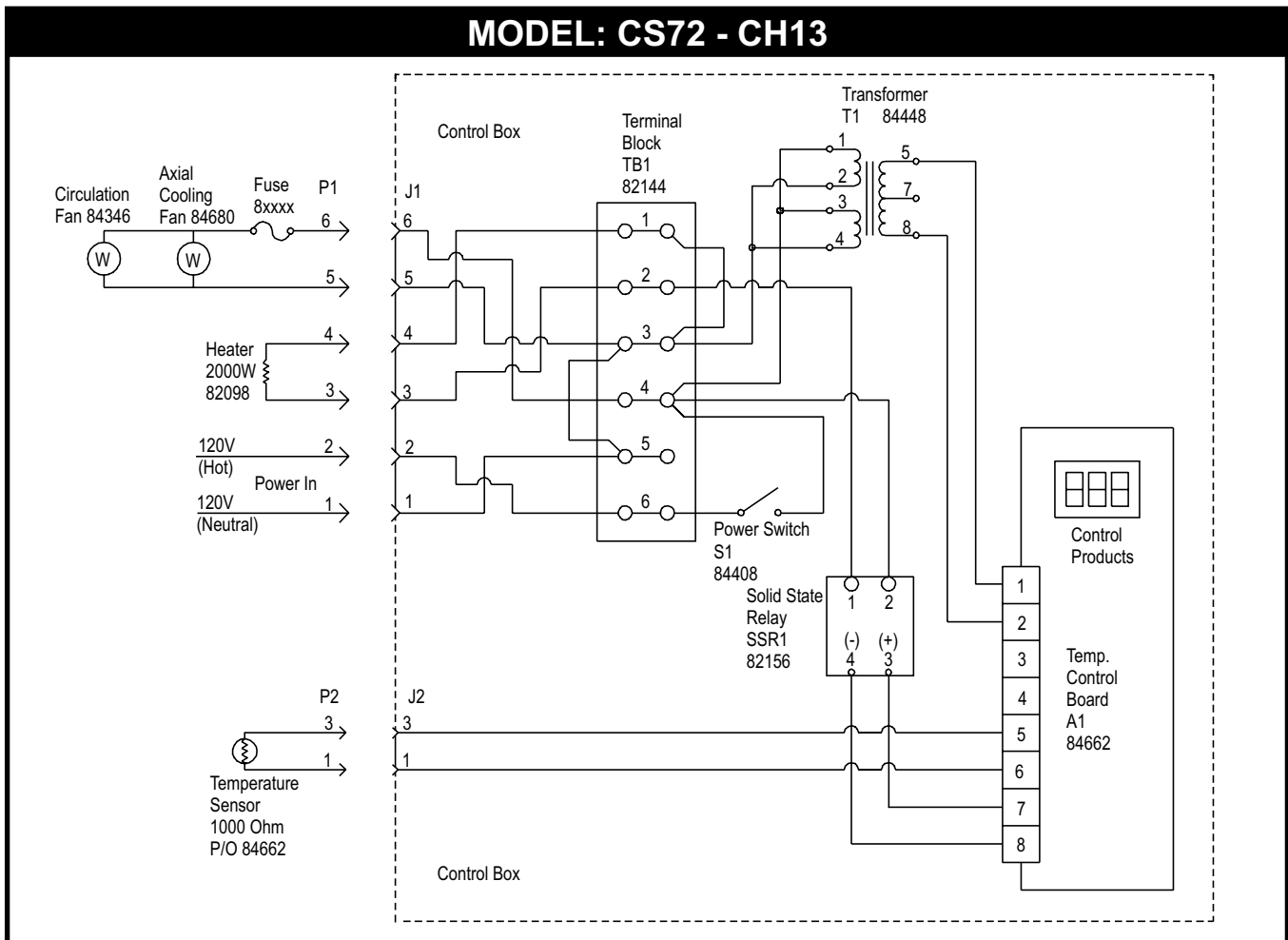

PARTS LIST - HOT HOLDING CABINET - MODEL: CS72 - CH13

ITEM	PART NUMBER	DESCRIPTION	QUANTITY
1	780036	CASTER WITH BRAKE	2
2	780040	CASTER	2
3	783082	MAGNETIC LATCH	4
4	720190	TOP MODULE	1
5	720191	CONTROL MODULE	1
6	720153	DOOR WITH WINDOW	2
7	720150	DOOR	2
8	784692	HINGE	8
9	747333	BOTTOM AIR DUCT-#1	1
10	720146	BOTTOM RIGHT AIR DUCT - #2	1
11	720143	BOTTOM LEFT AIR DUCT - #3	1
12	720147	TOP RIGHT AIR DUCT - #4	1
13	720144	TOP LEFT AIR DUCT-#5	1
14	784823	DOOR GASKET	4
15	784448	TRANSFOMER	1
16	783015	SPACER, NYLON #4	4
17	784662	TEMP. CONTROL PC. BOARD	1
18	782144	TERMINAL BLOCK	1
19	782156	RELAY	1
20	784700	WIRE SET	1
21	784548	MOUNTING ADAPTER LOCK CONN - RED	2
22	784408	POWER SWITCH	1
23	782149	PLUG 4-PIN	1
24	784477	PLUG	1
25	701015	POWER CORD-8 FT	1
26	782098	HEATER ELEMENT	1
27	782208	THERMOSTAT	1
28	783032	CONNECTOR-ELBOW 90 DEGREE	2
29	720193	WATER PAN	1
30	741040	WATER PAN BAFFLE	3
31	784346	BLOWER MOTOR	1
32	784595	FUSE HOLDER	1
33	784596	FUSE, 4 AMP.	1
34	784680	AXIAL COOLING FAN	1
35	784684	AXIAL CORD - COOLING FAN	1
36	784724	CERAMIC INSULATOR	4



8. BEVLES COMPANY LIMITED WARRANTY

729 Third Avenue * Dallas, TX 75226

Phone: +1 (214) 421-7366 Fax: +1 (214) 565-0976

1. Bevles warrants to the original purchaser that on the date the equipment is shipped (sold), it will be free of defects in materials or workmanship. Bevles will, at it's discretion, repair or replace, during the warranty period printed below, any part that has a defect in material or workmanship that was present when the product shipped from Bevles, and which manifests itself during the warranty period under normal use and service.
 - Parts: Two* years from date of original shipment from the Bevles factory.
 - Labor: One** year from date of original shipment from the Bevles factory.

* Air Circulation Blower Assemblies (motors) and Power Switches shall be one year from date of original shipment.

Calrod "Air" Heating Elements shall be three years from date of original shipment.

** All electrical components 120 days from date of original shipment.
2. Bevles must be contacted, and pre-approval must be issued by the Bevles factory prior to any type of service being performed. Bevles assumes no responsibility for any charges that were not expressly authorized by the Bevles factory, or for any charges that exceed, in Bevles' sole judgement, normal and customary amounts.
3. Bevles will pay UPS Ground charges for any part that has a defect in material or workmanship that was present when the product shipped from Bevles, and which manifests itself during the **first year** of the warranty period under normal use and service. All warranty replacement parts will ship F.O.B. Bevles factory, Chino, CA 91710.
4. This warranty shall be void in its entirety if any abuse of, misuse of, alteration/modification of or improper maintenance of original product occurs. If, at any time a claim is reported to Bevles, the purchaser is delinquent in payment for the product, warranty will not apply.
5. Buyer's Remedies-If a Bevles product fails due to a defect in material or workmanship in conformity with the warranties in paragraph one, buyer shall notify Bevles of such failure within a reasonable time, but in no event beyond fifteen (15) days of such discovery of defect in material or workmanship. Bevles shall provide, in its sole discretion, either the repair or replacement of any defective or any non-conforming part. Bevles specifically disavows any other representation, warranty or liability relating to the continued use of the product.
6. Exclusion of consequential and incidental damages-In no event shall Bevles be liable for any incidental, special, indirect, or consequential damages, whether resulting from non-delivery or from the use, misuse, or inability to use the product, or from defects in the product, or from Bevles' own negligence or other tort. This exclusion applies regardless of whether such damages are sought for breach of warranty, breach of contract, negligence, or strict liability in tort or under any other legal theory.
7. Disclaimer of warranties-The warranties contained in paragraph one above are the exclusive warranties given by Bevles and supersede any prior, contrary, or additional representations, whether oral or written. Bevles hereby disclaims and excludes all other warranties-whether expressed, implied, or statutory-including any warranty of merchantability, any warranty of fitness for a particular purpose, and any implied warranties otherwise arising from course of dealing or usage of trade.