







Installation, Operation, & Maintenance
Model: C28M, Electric Marine Fryer (208/240-Volt)



THE INFORMATION IN THIS MANUAL IS CRUCIAL AND MUST BE RETAINED FOR FUTURE REFERENCE. READ, UNDERSTAND AND FOLLOW THE INSTRUCTIONS AND WARNINGS CONTAINED IN THIS MANUAL.

DANGER	POTENTIALLY HAZARDOUS SITUATION WHICH, IF NOT AVOIDED, COULD RESULT IN DEATH.	
WARNING	POTENTIALLY HAZARDOUS SITUATION WHICH, IF NOT AVOIDED, COULD RESULT IN DEATH OR SERIOUS INJURY.	
CAUTION	POTENTIALLY HAZARDOUS SITUATION WHICH, IF NOT AVOIDED, MAY RESULT IN MINOR OR MODERATE INJURY.	
NOTICE	Helpful operation and installation instructions and tips are present.	

FOR YOUR SAFETY

DO NOT STORE OR USE GASOLINE OR OTHER FLAMMABLE VAPORS AND LIQUIDS IN THE VICINITY OF THIS OR ANY OTHER APPLIANCE.

WARNING: IMPROPER INSTALLATION, ADJUSTMENT, ALTERATION, SERVICE OR MAINTENANCE CAN CAUSE PROPERTY DAMAGE, INJURY OR DEATH. READ THE INSTALLATION, OPERATING AND MAINTENANCE INSTRUCTIONS THOROUGHLY BEFORE INSTALLING OR SERVICING THIS EQUIPMENT.

Model #:	Purchased From:
Serial #:	Location:
Date Purchased:	Date Installed:
Purchase Order #:	For Service, Call:















WARNING	THIS EQUIPMENT IS APPROVED FOR INSTALLATION ONLY ON VESSELS GREATER THAN 65 FEET IN LENGTH, IN ACCORDANCE WITH USCG REGULATIONS IN TITLE 46 CFR 110-113	
----------------	---	---

TABLE OF CONTENTS

<u>CHAPTER</u>	<u>PAGE</u>
1. TABLE OF CONTENTS.....	3
2. LIST OF ILLUSTRATIONS	4
3. READ FIRST.....	5
4. SPECIFICATION SHEET	7
5. LEG SPECIFICATION	9
6. EQUIPMENT DESCRIPTION	11
7. UNPACKING.....	11
8. INSTALLATION	12
9. OPERATION.....	13
10. MAINTENANCE & CLEANING	15
11. PARTS LIST	18
12. WIRING DIAGRAM.....	19
13. WARRANTY	21

LIST OF ILLUSTRATIONS

<u>ILLUSTRATION</u>	<u>PAGE</u>
1. SPECIFICATION SHEET	7
2. LEG LAYOUT	9
3. OIL FILL LEVEL.....	13
4. WIRING DIAGRAM.....	19

CAUTION	EACH UNIT IS EXTREMELY HEAVY. FOR SAFE HANDLING, INSTALLER SHOULD OBTAIN HELP AS NEEDED, OR EMPLOY APPROPRIATE MATERIALS HANDLING EQUIPMENT (SUCH AS A FORKLIFT, DOLLY, OR PALLET JACK) TO REMOVE THE UNIT FROM THE SKID AND MOVE IT TO THE PLACE OF INSTALLATION.	
CAUTION	ANY STAND, COUNTER OR OTHER DEVICE ON WHICH THE FRYER WILL BE LOCATED MUST BE DESIGNED TO SUPPORT THE WEIGHT OF THE FRYER.	
CAUTION	SHIPPING STRAPS ARE UNDER TENSION AND CAN SNAP BACK WHEN CUT.	
DANGER	THIS APPLIANCE MUST BE GROUNDED AT THE TERMINAL PROVIDED. FAILURE TO GROUND THE APPLIANCE COULD RESULT IN ELECTROCUTION AND DEATH.	
WARNING	INSTALLATION OF THE UNIT MUST BE DONE BY PERSONNEL QUALIFIED TO WORK WITH ELECTRICITY AND PLUMBING. IMPROPER INSTALLATION CAN CAUSE INJURY TO PERSONNEL AND/OR DAMAGE TO EQUIPMENT. UNIT MUST BE INSTALLED IN ACCORDANCE WITH ALL APPLICABLE CODES.	
NOTICE	The data plate is located behind the access door, over the tank drain. The fryer voltage, wattage, serial number, wire size, and clearance specifications are on the data plate. This information should be carefully read and understood before proceeding with the installation.	
NOTICE	The installation of any components such as a vent hood, grease extractors, fire extinguisher systems, must conform to their applicable National, State and locally recognized installation standards.	
WARNING	MAKE SURE THE MAIN POWER SUPPLY TO THE FRYER IS TURNED <u>OFF</u> AT THE SOURCE PRIOR TO CONNECTING POWER TO THE FRYER.	
CAUTION	BE SURE THE POWER SUPPLY VOLTAGE MATCHES THE VOLTAGE SPECIFIED ON THE DATA PLATE.	
WARNING	NEVER ENERGIZE THE HEATING ELEMENTS WITH NO OIL IN THE KETTLE OR WITH THE OIL LEVEL MORE THAN 3-INCHES FROM THE LOWER FILL LEVEL	
WARNING	ALWAYS TURN THE FRYER POWER SWITCH OFF BEFORE LIFTING THE HEATING ELEMENTS OUT OF THE FRYER OIL.	
CAUTION	ALWAYS KEEP THE AREA NEAR THE APPLIANCE FREE FROM COMBUSTIBLE MATERIALS.	
CAUTION	KEEP FLOOR IN FRONT OF EQUIPMENT CLEAN AND DRY. IF SPILLS OCCUR, CLEAN IMMEDIATELY, TO AVOID THE DANGER OF SLIPS OR FALLS.	
WARNING	KEEP WATER AND SOLUTIONS OUT OF CONTROLS. NEVER SPRAY OR HOSE CONTROL CONSOLE, ELECTRICAL CONNECTIONS, ETC.	

CAUTION	MOST CLEANERS ARE HARMFUL TO THE SKIN, EYES, MUCOUS MEMBRANES AND CLOTHING. PRECAUTIONS SHOULD BE TAKEN TO WEAR RUBBER GLOVES, GOGGLES OR FACE SHIELD AND PROTECTIVE CLOTHING. CAREFULLY READ THE WARNING AND FOLLOW THE DIRECTIONS ON THE LABEL OF THE CLEANER TO BE USED.
NOTICE	Service on this, or any other, LANG appliance must be performed by qualified personnel only. Consult your authorized service station directory or call the factory at 1-800-224-LANG (5264), or WWW.LANGWORLD.COM For the service station nearest you.
WARNING	BOTH HIGH AND LOW VOLTAGES ARE PRESENT INSIDE THIS APPLIANCE WHEN THE UNIT IS PLUGGED/WIRED INTO A LIVE RECEPTACLE. BEFORE REPLACING ANY PARTS, DISCONNECT THE UNIT FROM THE ELECTRIC POWER SUPPLY.
CAUTION	USE OF ANY REPLACEMENT PARTS OTHER THAN THOSE SUPPLIED BY LANG OR THEIR AUTHORIZED DISTRIBUTORS CAN CAUSE BODILY INJURY TO THE OPERATOR AND DAMAGE TO THE EQUIPMENT AND WILL VOID ALL WARRANTIES.



SPECIFICATION SHEET

SPECIFICATION SHEET

LEG SPECIFICATION

F-28M & R-28M

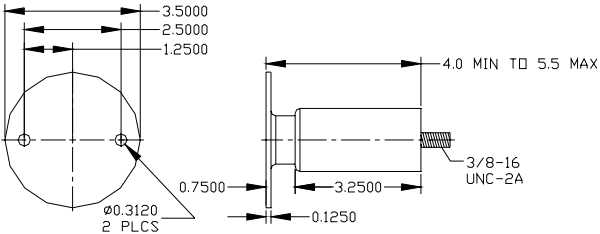
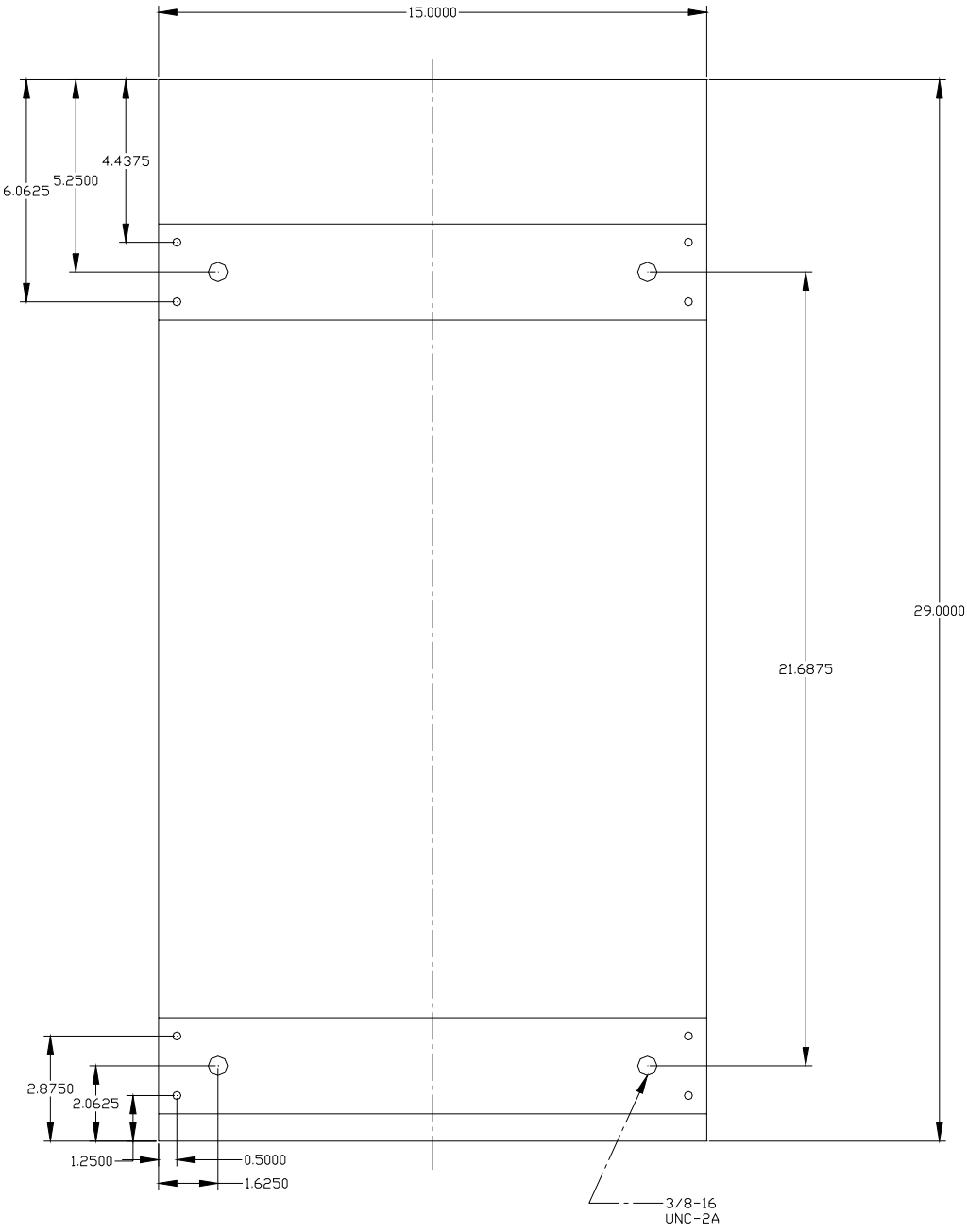

LEG SPECIFICATION

C-28M

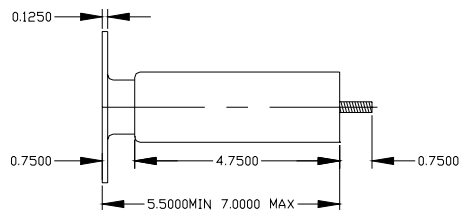
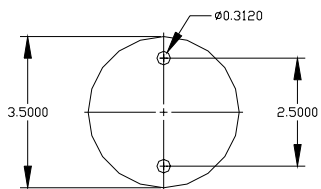
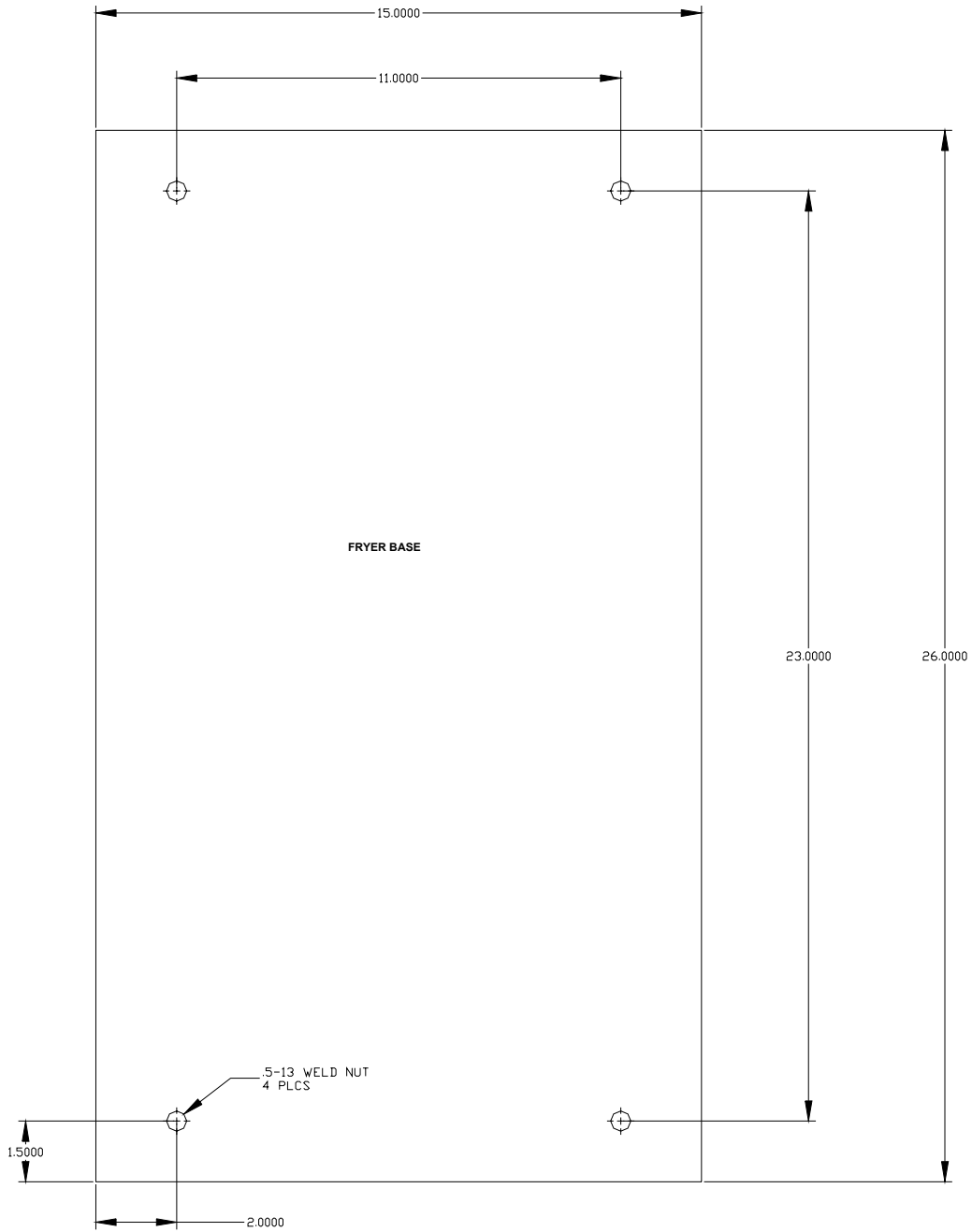

EQUIPMENT DESCRIPTION

ITEMS

- 1 ea. C-28M or 1ea. F-28M or 1ea R-28M
- 4 ea. 6", Bolt down legs (F-28M)
- 4 ea. 4", Bolt down legs (C-28M)
- 1 ea. Operation Manual
- 1 ea. Marine Handle

FRYER CONTROLS

The Fryer comes with an "ON / OFF toggle switch, one mechanical thermostat that has a temperature range of 200°F -400°F and three indicator lamps for power, heat, and over temperature. In addition to the standard controls, the fryer comes with a power interrupt terminal block, an optional shunt trip terminal block and a optional over temperature thermostat test switch.

UNPACKING

CAUTION	EACH IS EXTREMELY HEAVY. FOR SAFE HANDLING, INSTALLER SHOULD OBTAIN HELP AS NEEDED, OR EMPLOY APPROPRIATE MATERIALS HANDLING EQUIPMENT (SUCH AS A FORKLIFT, DOLLY, OR PALLET JACK) TO REMOVE THE UNIT FROM THE SKID AND MOVE IT TO THE PLACE OF INSTALLATION.
CAUTION	ANY STAND, COUNTER OR OTHER DEVICE ON WHICH THE FRYER WILL BE LOCATED MUST BE DESIGNED TO SUPPORT THE WEIGHT OF THE FRYER.
CAUTION	SHIPPING STRAPS ARE UNDER TENSION AND CAN SNAP BACK WHEN CUT.



RECEIVING THE FRYER

Upon receipt, check for freight damage, both visible and concealed. Visible damage should be noted on the freight bill at the time of delivery and signed by the carrier's agent. Concealed loss or damage means loss or damage, which does not become apparent until the merchandise has been unpacked. If concealed loss or damage is discovered upon unpacking, make a written request for inspection by the carrier's agent within 15 days of delivery. All packing material should be kept for inspection. Do not return damaged merchandise to Lang Manufacturing Company. File your claim with the carrier.

LOCATION

Prior to un-crating, move the fryer as near its intended location as practical. The crating will help protect the unit from the physical damage normally associated with moving it through hallways and doorways.

UN-CRATING

The fryer will arrive inside a wood frame covered by a cardboard box and strapped to a skid. Remove the cardboard cover, cut the straps and remove the wood frame. The fryer may now be removed from the skid.

INSTALLING THE LEGS

To install the legs, place some cardboard on the floor and gently tip the fryer portion onto its side. A threaded weld nut is provided in each of the four corners of the unit. Thread each leg into the threaded weld nuts and lift the fryer back onto the legs. (See "Leg Specification").

INSTALLATION

DANGER THIS APPLIANCE MUST BE GROUNDED AT THE TERMINAL PROVIDED. FAILURE TO GROUND THE APPLIANCE COULD RESULT IN ELECTROCUTION AND DEATH.

WARNING INSTALLATION OF THE UNIT MUST BE DONE BY PERSONNEL QUALIFIED TO WORK WITH ELECTRICITY AND PLUMBING. IMPROPER INSTALLATION CAN CAUSE INJURY TO PERSONNEL AND/OR DAMAGE TO EQUIPMENT. UNIT MUST BE INSTALLED IN ACCORDANCE WITH ALL APPLICABLE CODES.



NOTICE The data plate is located behind the access door, over the tank drain. The fryer voltage, wattage, serial number, wire size, and clearance specifications are on the data plate. This information should be carefully read and understood before proceeding with the installation.

NOTICE The installation of any components such as a vent hood, grease extractors, fire extinguisher systems, must conform to their applicable National, State and locally recognized installation standards.

ELECTRICAL CONNECTION

A 1¼” knockout is provided on the unit for electrical connection (see “Specification Sheet for knockout location).

The electrical connection must be made in accordance with local codes or in the absence of local codes with **National Electrical Code** latest edition (in Canada use: **CSA STD. C22.1**).

SAFETY CIRCUIT CONNECTIONS

Fire Control Shutoff

A two pole terminal block is provided behind the rear access cover for connection to an external fire control system if required. A jumper is provided across two of these terminals when the fryer leaves the factory. The jumper on this terminal block is in series with the power switch circuit. If connection to a fire control system is required, remove this jumper and supply a relay contact closure to maintain this closed circuit. If the fire control system does not have this type of output, a separate relay must be provided to interface the system. **DO NOT APPLY VOLTAGE TO THIS CONNECTION.**

Optional Shunt Trip Circuit

Two terminals are provided on the four pole terminal block for a shunt trip circuit.

The Fryer can now be connected to power.

CAUTION BE SURE THE POWER SUPPLY VOLTAGE MATCHES THE VOLTAGE SPECIFIED ON THE DATAPLATE.



CAUTION

NEVER ENERGIZE THE HEATING ELEMENTS WITH NO OIL IN THE KETTLE OR WITH THE OIL LEVEL MORE THAN 3-INCHES FROM THE LOWER FILL LEVEL



FILLING THE FRYER

Fill the fryer with cooking oil. There are two fill marks on the sides of the kettle. The oil level should be maintained between the upper and lower marks. When the elements are out of the unit the oil should not sink below the bottom fill mark and when the elements are in the oil it should not rise above the top fill mark.

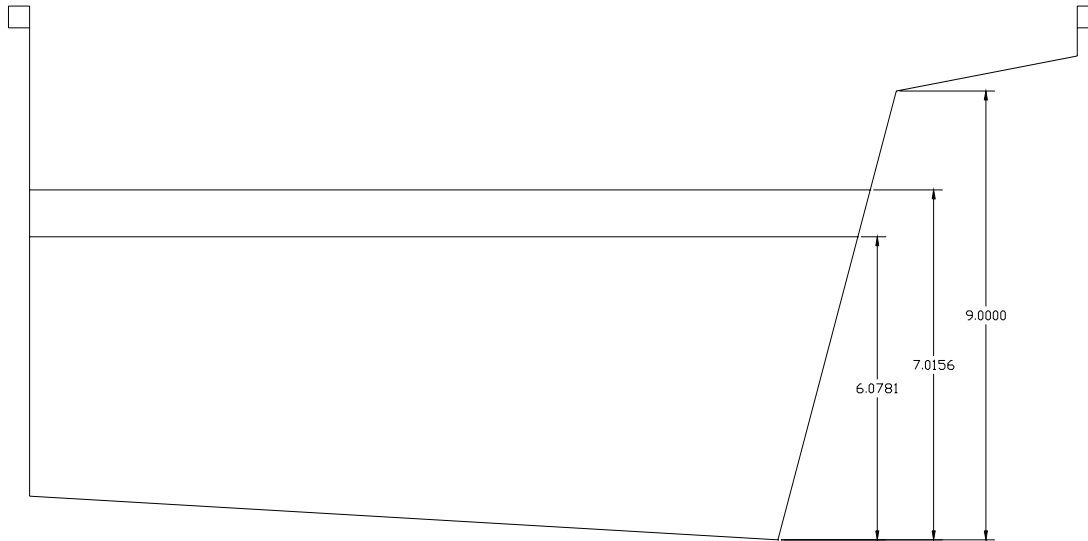

TURNING THE FRYER ON

The power switch on the control box at the front of the fryer energizes the control circuits. When this switch is on, the “power” indicator lamp will be illuminated.

SETTING THE TEMPERATURE

Turn the temperature selector dial on the thermostat to the desired temperature setting. This control is located above the elements at the rear of the kettle. The “heat” indicator lamp will illuminate indicating power is applied to the heating elements.

OVER-TEMPERATURE INDICATOR

The lamp marked “over temp” will illuminate if the oil reaches an over temperature condition. The over temperature thermostat shuts off the fryer before the oil reaches a dangerously high temperature.

CAUTION

ALWAYS TURN THE FRYER POWER SWITCH OFF BEFORE LIFTING THE HEATING ELEMENTS OUT OF THE FRYER OIL.



RAISING THE ELEMENTS

The elements may be raised and locked in the up position. The latch is located on the rear top surface of the fryer and may be activated by lifting the handle at either side of the fryer.

DRAINING THE OIL

A drain valve is provided at the left front of the fryer. A lever that is located inside the access panel is used to open and close the drain valve.

To drain the oil, make sure that the valve is closed and the oil is cool. Remove the steel cap from the drain pipe. Connect a drain pipe extension to the drain pipe. Move the lever into the open position and allow to drain. Close valve after draining is complete and replace the end cap.

CONTROLS

- Power Switch-** A toggle switch used to turn the unit on and off.
- Pilot Lights-** Lights that are located in the rear control panel area.
- Power-** Lights up when the power switch is in the "ON" position.
- Heat-** Lights up when the element contactors engage.
- Over-temp-** Lights up when the over-temperature thermostat trips.
- Test Switch-** The limiting control test switch, located at the front control panel is a spring loaded, single pole double throw switch for testing the over-temp thermostat. Activating this switch is accomplished by pulling up and holding the toggle. During this time, the solid state controller is bypassed, and the heat light is on. When the oil temperature reaches approximately 425° F. the heat light goes out and the over-temp light comes on.

MAINTENANCE & CLEANING

CAUTION	ALWAYS KEEP THE AREA NEAR THE APPLIANCE FREE FROM COMBUSTIBLE MATERIALS.
CAUTION	KEEP FLOOR IN FRONT OF EQUIPMENT CLEAN AND DRY. IF SPILLS OCCUR, CLEAN IMMEDIATELY, TO AVOID THE DANGER OF SLIPS OR FALLS.
WARNING	KEEP WATER AND SOLUTIONS OUT OF CONTROLS. NEVER SPRAY OR HOSE CONTROL CONSOLE, ELECTRICAL CONNECTIONS, ETC.
CAUTION	MOST CLEANERS ARE HARMFUL TO THE SKIN, EYES, MUCOUS MEMBRANES AND CLOTHING. PRECAUTIONS SHOULD BE TAKEN TO WEAR RUBBER GLOVES, GOGGLES OR FACE SHIELD AND PROTECTIVE CLOTHING. CAREFULLY READ THE WARNING AND FOLLOW THE DIRECTIONS ON THE LABEL OF THE CLEANER TO BE USED.



FRYER CLEANING

DAILY CLEANING:

It is recommended the fryer oil be kept as clean as possible by straining regularly (several times a day) and filtering daily. This will lengthen the life of your oil and improve the performance of the fryer.

WEEKLY OR AS REQUIRED:

1. Turn power switch off.
2. Remove the baskets, let baskets drain and then set aside.
3. Raise heating elements out of oil and lock in up position.
4. Drain Oil (See Draining the oil on previous page).
5. Remove loose food particles from heating units with spatula and wire brush.
6. Flush out scrapings and sediment with a small quantity of hot oil, and allow to drain thoroughly.
7. Close drain valve and fill with a fryer cleaning agent or soapy solution of non-corrosive grease dissolving cleaner.
8. Set thermostat to 250°F. and boil solution for 15 to 20 minutes.
9. Drain solution from kettle. Refill with water and add 1/2 cup of white vinegar to neutralize alkaline left by soap. Bring solution to a boil and allow to stand for a few minutes.
10. Drain kettle and rinse with clear, hot water. Dry kettle and heating units thoroughly, and close drain valve.
11. Refill fryer with oil, and lower heating elements slowly.
12. Operate fryer as normal.

EMERGENCY LOCKOUT

Locate power disconnect at source and remove power from fryer.

LONG TERM STORAGE

Secure fryer from power.

Drain oil from kettle.

Apply a generous amount of Lang Mfg. Prima Shine (72804-41) to the stainless steel.

TEMPERATURE CONTROL

A bulb thermostat located near the right heating element as the fryer is viewed from the front provides temperature control. This thermostat controls the #1 contactor. The control portion of the thermostat is located in the component box at the back of the fryer.

OVER-TEMPERATURE PROTECTION

The over-temperature thermostat is located next to the left heating element and provides protection in case of malfunction of the temperature control. It will open both contactors removing all power from the heating elements.

OPTIONAL SHUNT TRIP PROTECTION

The shunt trip temperature thermostat located next to the center-heating element provides protection in case of malfunction of the temperature control. It is used in conjunction with a shunt trip circuit, which will disconnect power to the fryer at the circuit breaker.

THERMOSTAT BULBS CHECK

The three thermostat bulbs, (temperature control thermostat bulb, over-temperature thermostat bulb and shut trip thermostat bulb), are all connected to the fryer heating elements. The brackets that hold these bulbs in place should be checked on a regular basis for tightness. If any of the brackets/ bulbs become loose, the brackets that hold the bulbs should be tightened right away.

COMPONENT ACCESS

The temperature control thermostat, over temperature thermostat, and shunt trip thermostat are all located in the component box at the back of the fryer as well as the indicator lamps. This box may be removed by removing the 4 sheet metal screws located beneath the box on the left and right sides of the fryer lower front. All other components are located at the base of the unit in the back or behind the access panel in the front to the unit.

In the event the fryer is built into a location, all maintenance may be done from the front by removing the oil pot to gain access to the components. To remove the pot, the control box must be removed as above. Also, remove the small section of sheet metal baffle held on by 2 sheet metal screws, located just above the drain valve. The front of the pot may now be lifted up and moved forward until the rear of the pot will rotate up and out. The baffles behind the pot may be removed by taking out the 4 screws. This exposes the components.

CALIBRATION

The Fryer calibration procedure consists of accessing and adjusting the temperature thermostat. The temperature control thermostat is located behind the component box on the top at the back of the fryer.

Calibration Check

- Remove the elements from the fryer tank and wrap a temperature-sensing probe around the capillary tube of the temperature control thermostat.
- Place elements back in fryer tank and set thermostat to 350°F.
- Allow fryer to reach temperature and cycle for 15 minutes.
- After fryer has cycled for 15 minutes, record the on and off temperatures for three cycles and average these temperatures together (add together and divide by six), the temperature should be between 340-360°F.

Calibration Adjustment

The average temperature should only be 340-360°F. If temperature is off, then a 1/16" flat blade screwdriver with a 2" shaft is required to make adjustments on the thermostat.

- Maintain the temperature at 350°F.
- Without turning the thermostat, remove the knob.
- Locate the adjustment screw at the base of the shaft and insert the screwdriver.
- Grasp the shaft and turn the screw, counter clockwise to increase and clockwise to decrease, (1/8 of a turn will move the temperature 5-7 °F in either direction).
- Reinstall the oven knob and recheck the oven temperature.

NOTICE

Service on this, or any other, LANG appliance must be performed by qualified personnel only. Consult your authorized service station directory or call the factory at 1-800-224-LANG (5264), or WWW.LANGWORLD.COM For the service station nearest you.



WARNING

BOTH HIGH AND LOW VOLTAGES ARE PRESENT INSIDE THIS APPLIANCE WHEN THE UNIT IS PLUGGED/WIRED INTO A LIVE RECEPTACLE. BEFORE REPLACING ANY PARTS, DISCONNECT THE UNIT FROM THE ELECTRIC POWER SUPPLY.



CAUTION

USE OF ANY REPLACEMENT PARTS OTHER THAN THOSE SUPPLIED BY LANG OR THEIR AUTHORIZED DISTRIBUTORS CAN CAUSE BODILY INJURY TO THE OPERATOR AND DAMAGE TO THE EQUIPMENT AND WILL VOID ALL WARRANTIES.



TROUBLE SHOOTING

Not Heating

<u>PROBABLE CAUSE</u>	<u>CORRECTIVE ACTION</u>
<u>Incorrect wiring</u>	Confirm that fryer is getting proper voltage. Confirm that fryer is phased correctly.
<u>Defective transformer</u>	Confirm that transformer is getting correct voltage. Confirm that transformer is putting out correct voltage.
<u>Defective Fuses</u>	Replace fuses.
<u>Defective Contactor</u>	Confirm that contactor is getting correct voltage on the coil.
<u>Defective Thermostat</u>	Confirm that thermostat is getting correct voltage. Confirm that thermostat is operating properly.
<u>Defective Element</u>	Confirm that element is getting correct voltage Check element for normal operation. (11.5 Amps)

PARTS LIST

<u>DESCRIPTION</u>	<u>PART NO.</u>
Element C28 Fryer 208 Volt 4000 Watts	11110-43
Element C28 Fryer 240 Volt 4000 Watts	11110-44
Switch Toggle On-Off	30303-06
Boot Threaded for Metal Toggle Switch	30303-15
Thermostat Safety 450°F Open	30401-13
Thermostat 400°F Fryer	30402-12
Terminal Strip 2 Pole	30500-01
Contactor 3 Pole 208/240 VAC	30700-03
Fuse 15 Amp	30900-01
Fuse 3 Amp	30900-15
Fuse Holder 15 Amp	30901-02
Pilot Light 208/240V 6" Lead Black Body	31601-01
Grab Bar Assembly 15"	50300-49
Basket Fryer Twin	50600-09
Basket Fryer Full	50600-02
Basket Hanger Assembly Non-Lift	51100-02
Drain Elbow Assembly	51100-16
Lift Handle	60102-21
Lower Element Clip	60102-31
Bottom Element Clamp	60102-32
Element Clamp	60102-321
Upper Element Clip	60102-78
Thermostat Capillary Tube Spacer	60102-79
Capillary Tube Spacer	60102-80
Small Capillary Tube Clip	60102-81
High Limit Thermostat Spacer	60102-82
Fryer Bucket	60102-800
Panel Label C28	60301-16
Valve Manual Drain	70400-01
Knob Temperature Control	70701-06
Plastic Capillary Tube Bushing	70801-05
Cap Drain Plug	70900-01
Roll Pin 1/4" X 1	71800-02

WIRING DIAGRAM

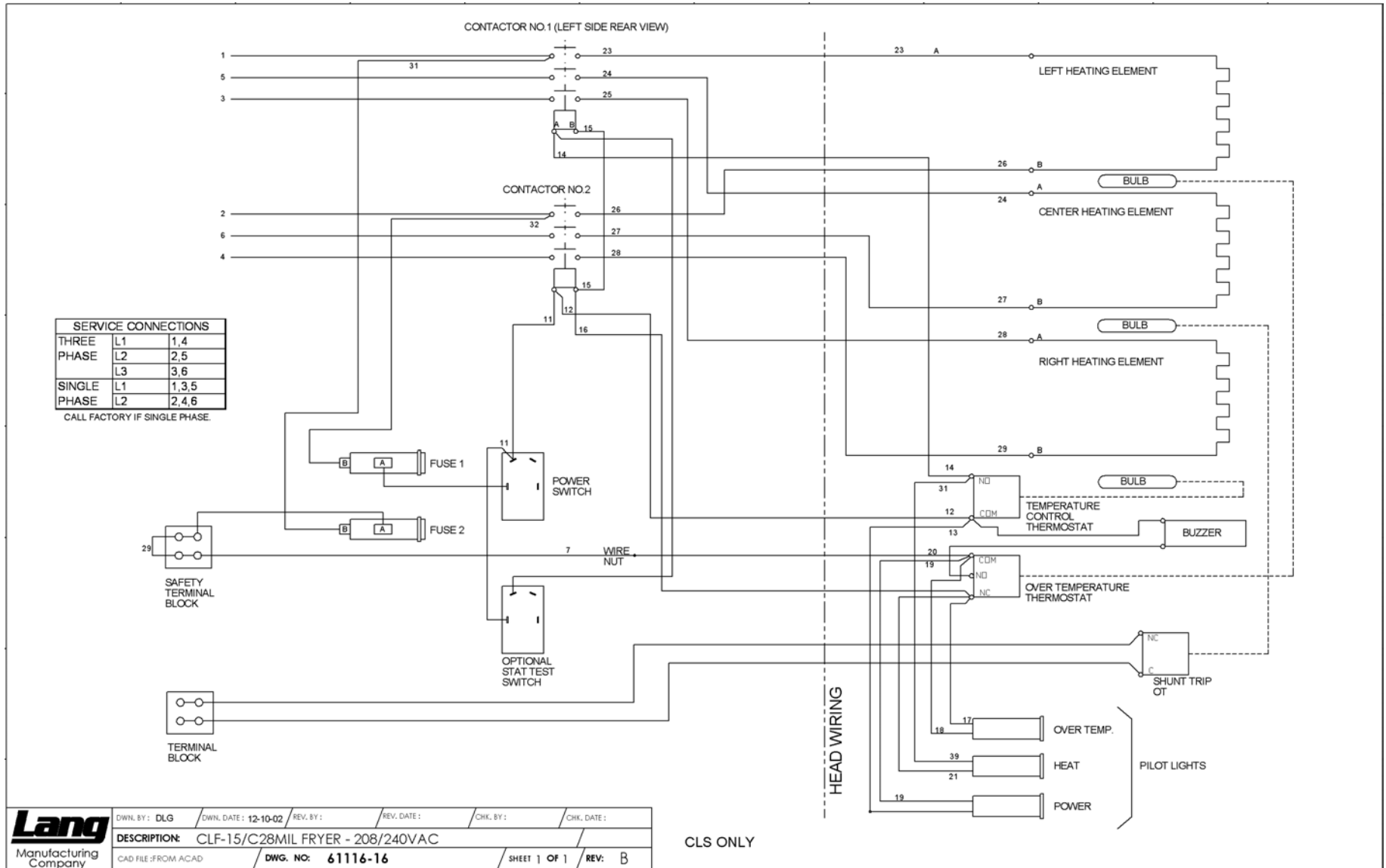

**This Page
Intentionally
Left Blank**

**Lang Manufacturing Limited
Warranty
to Commercial Purchasers*
(Domestic U.S., Hawaii, &
Canadian Sales only.)**

Lang Manufacturing Equipment ("Lang Equipment") has been skillfully manufactured, carefully inspected and packaged to meet rigid standards of excellence. Lang warrants its Equipment to be free from defects in material and workmanship for (12) twelve consecutive months, with the following conditions and subject to the following limitations.

- I. This parts and labor warranty is limited to Lang Equipment sold to the original commercial purchaser/users (but not original equipment manufacturers), at its original place of installation, in the continental United States, Hawaii and Canada.

Quartz elements are warranted for ninety(90) days from the date of installation.
- II. Damage during shipment is to be reported to the carrier, is not covered under this warranty, and is the sole responsibility of purchaser/user.
- III. Lang, or an authorized service representative, will repair or replace, at Lang's sole election, and Lang Equipment, including but not limited to, safety valves, gas and electric components, found to be defective during the warranty period. As to warranty service in the territory described above, Lang will absorb labor and portal to portal transportation costs (time & mileage) for the first (12) twelve months from the date of installation or eighteen (18) months from date of shipment from Lang Manufacturing, which ever comes first.
- IV. This warranty does not cover routine general maintenance, periodic adjustments, as specified in operating instructions or manuals, and consumable parts such as quartz elements, or labor costs incurred for removal of adjacent equipment or objects to gain access to Lang Equipment. This warranty does not cover defects caused by improper installation, abuse, careless operation, or improper maintenance of equipment.
- V. THIS WARRANTY IS EXCLUSIVE AND IS IN LIEU OF ALL OTHER WARRANTIES, EXPRESSED OR IMPLIED, INCLUDING ANY IMPLIED WARRANTY OF MERCHANTABILITY OR FITNESS FOR A PARTICULAR PURPOSE, EACH OF WHICH IS HEREBY EXPRESSLY DISCLAIMED. THE REMEDIES DESCRIBED ABOVE ARE EXCLUSIVE AND IN NO EVENT SHALL LANG BE LIABLE FOR SPECIAL, CONSEQUENTIAL OR INCIDENTAL DAMAGES FOR THE BREACH OR DELAY IN PERFORMANCE OF THIS WARRANTY.
- VI. Lang Equipment is for commercial use only. If sold as a component of another(OEM) manufacturer's equipment, or if used as a consumer product, such Equipment is sold AS IS and without any warranty.