

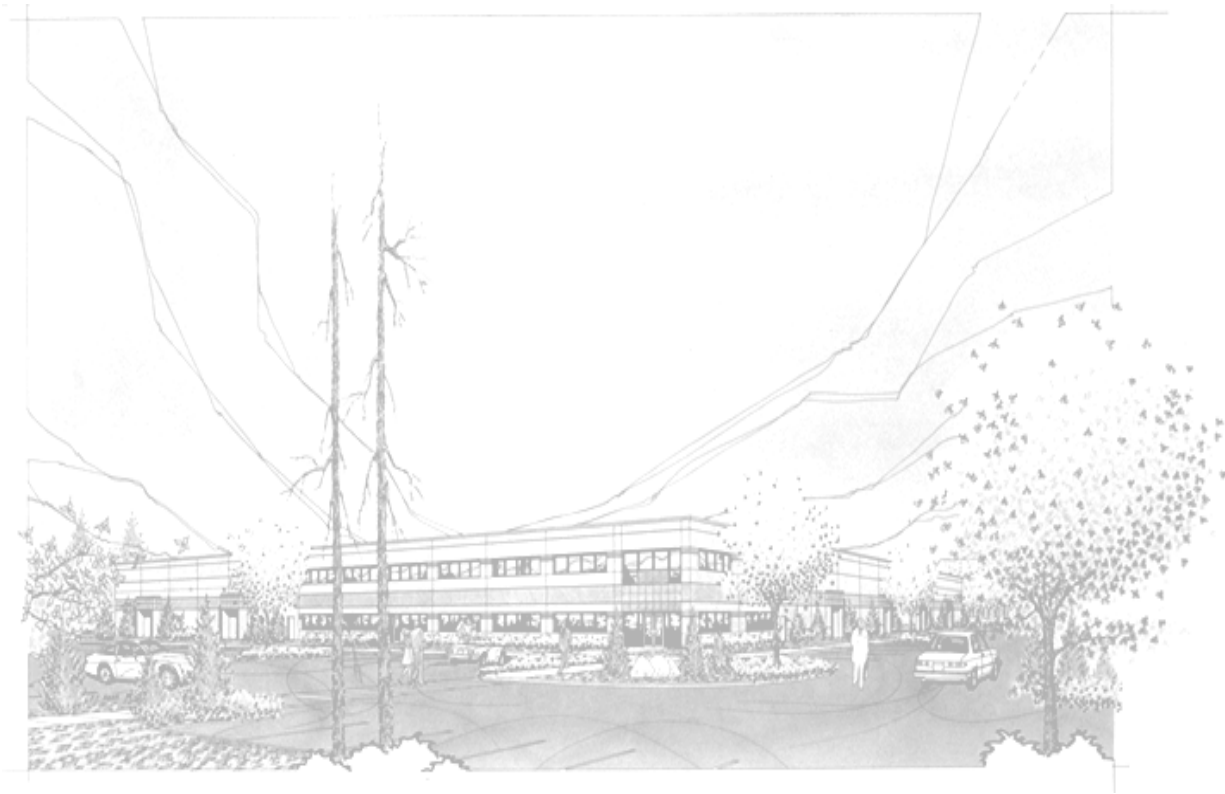

Installation, Operation, Maintenance, & Troubleshooting

Model: CLCN36-H-S Electric Cruise Line Hot Top Range with Cabinet Base





Serial:



THIS MANUAL MUST BE RETAINED FOR FUTURE REFERENCE. READ, UNDERSTAND AND FOLLOW THE INSTRUCTIONS AND WARNINGS CONTAINED IN THIS MANUAL.

FOR YOUR SAFETY
DO NOT STORE OR USE GASOLINE OR OTHER FLAMMABLE VAPORS AND LIQUIDS IN THE VICINITY OF THIS OR ANY OTHER APPLIANCE.

WARNING: IMPROPER INSTALLATION, ADJUSTMENT, ALTERATION, SERVICE OR MAINTENANCE CAN CAUSE PROPERTY DAMAGE, INJURY OR DEATH. READ THE INSTALLATION, OPERATING AND MAINTENANCE INSTRUCTIONS THOROUGHLY BEFORE INSTALLING OR SERVICING THIS EQUIPMENT.

<u>DANGER</u>	POTENTIALLY HAZARDOUS SITUATION WHICH, IF NOT AVOIDED, COULD RESULT IN DEATH.	
<u>WARNING</u>	POTENTIALLY HAZARDOUS SITUATION WHICH, IF NOT AVOIDED, COULD RESULT IN DEATH OR SERIOUS INJURY.	
<u>CAUTION</u>	POTENTIALLY HAZARDOUS SITUATION WHICH, IF NOT AVOIDED, MAY RESULT IN MINOR OR MODERATE INJURY.	
<u>NOTICE</u>	Helpful operation and installation instructions and tips are present.	

NOTICE: THIS EQUIPMENT IS APPROVED FOR INSTALLATION ONLY ON VESSELS GREATER THAN 65 FEET IN LENGTH, IN ACCORDANCE WITH USCG REGULATIONS IN TITLE 46 CFR 110-113. ANY WIRING USED IN THE INSTALLATION OF THIS APPLIANCE MUST BE STRANDED COPPER.

TABLE OF CONTENTS

TOPIC	PAGE
TABLE OF CONTENTS	3
IMPORTANT INSTRUCTIONS.....	4
UNPACKING.....	5
INSTALLATION	6
INITIAL START-UP.....	7
OPERATION.....	7
CLEANING.....	8
TROUBLESHOOTING	9
PARTS LISTS	10
EXPLODED VIEWS.....	11,12
WIRING DIAGRAMS	13

<u>CAUTION</u>	THE RANGE IS EXTREMELY HEAVY. FOR SAFE HANDLING, INSTALLER SHOULD OBTAIN HELP AS NEEDED, OR EMPLOY APPROPRIATE MATERIALS HANDLING EQUIPMENT (SUCH AS A FORKLIFT, DOLLY, OR PALLET JACK) TO REMOVE THE UNIT FROM THE SKID AND MOVE IT TO THE PLACE OF INSTALLATION.
<u>CAUTION</u>	ANY STAND, COUNTER OR OTHER DEVICE ON WHICH RANGE WILL BE LOCATED MUST BE DESIGNED TO SUPPORT THE WEIGHT OF THE RANGE.
<u>DANGER</u>	THIS APPLIANCE MUST BE GROUNDED AT THE TERMINAL PROVIDED. FAILURE TO GROUND THE APPLIANCE COULD RESULT IN ELECTROCUTION AND DEATH.
<u>WARNING</u>	INSTALLATION OF THE UNIT MUST BE DONE BY PERSONNEL QUALIFIED TO WORK WITH ELECTRICITY. IMPROPER INSTALLATION CAN CAUSE INJURY TO PERSONNEL AND/OR DAMAGE TO EQUIPMENT. UNIT MUST BE INSTALLED IN ACCORDANCE WITH ALL APPLICABLE CODES.
<u>NOTICE</u>	The data plate is located behind the access cover to the right of the oven door. The range voltage, wattage, serial number, wire size, and clearance specifications are on the data plate. This information should be carefully read and understood before proceeding with the installation.
<u>NOTICE</u>	The installation of any components such as a vent hood, grease extractors, fire extinguisher systems, must conform to their applicable National, State and locally recognized installation standards.
<u>CAUTION</u>	ALWAYS KEEP THE AREA NEAR THE APPLIANCE FREE FROM COMBUSTIBLE MATERIALS.
<u>CAUTION</u>	KEEP FLOOR IN FRONT OF EQUIPMENT CLEAN AND DRY. IF SPILLS OCCUR, CLEAN IMMEDIATELY, TO AVOID THE DANGER OF SLIPS OR FALLS.
<u>WARNING</u>	KEEP WATER AND SOLUTIONS OUT OF CONTROLS. NEVER SPRAY OR HOSE CONTROL CONSOLE, ELECTRICAL CONNECTIONS, ETC.
<u>CAUTION</u>	MOST CLEANERS ARE HARMFUL TO THE SKIN, EYES, MUCOUS MEMBRANES AND CLOTHING. PRECAUTIONS SHOULD BE TAKEN TO WEAR RUBBER GLOVES, GOGGLES OR FACE SHIELD AND PROTECTIVE CLOTHING. CAREFULLY READ THE WARNING AND FOLLOW THE DIRECTIONS ON THE LABEL OF THE CLEANER TO BE USED.
<u>NOTICE</u>	Service on this, or any other, LANG appliance must be performed by qualified personnel only. Consult your authorized service station directory or call the factory at 1-800-224-LANG (5264), or WWW.LANGWORLD.COM for the service station nearest you.
<u>WARNING</u>	BOTH HIGH AND LOW VOLTAGES ARE PRESENT INSIDE THIS APPLIANCE WHEN THE UNIT IS PLUGGED/WIRED INTO A LIVE RECEPTACLE. BEFORE REPLACING ANY PARTS, DISCONNECT THE UNIT FROM THE ELECTRIC POWER SUPPLY.
<u>CAUTION</u>	USE OF ANY REPLACEMENT PARTS OTHER THAN THOSE SUPPLIED BY LANG OR THEIR AUTHORIZED DISTRIBUTORS CAN CAUSE BODILY INJURY TO THE OPERATOR AND DAMAGE TO THE EQUIPMENT AND WILL VOID ALL WARRANTIES.



UNPACKING

CAUTION THE RANGE IS EXTREMELY HEAVY. FOR SAFE HANDLING, INSTALLER SHOULD OBTAIN HELP AS NEEDED OR EMPLOY APPROPRIATE MATERIALS HANDLING EQUIPMENT (SUCH AS A FORKLIFT, DOLLY OR PALLET JACK) TO REMOVE THE UNIT FROM THE SKID AND MOVE IT TO THE PLACE OF INSTALLATION.



CAUTION ANY STAND, COUNTER OR OTHER DEVICE ON WHICH RANGE WILL BE LOCATED MUST BE DESIGNED TO SUPPORT THE WEIGHT OF THE RANGE.



Receiving the Range

Upon receipt, check for freight damage, both visible and concealed. Visible damage should be noted on the freight bill at the time of delivery and signed by the carrier's agent. Concealed loss or damage means loss or damage which does not become apparent until the merchandise has been unpacked. If concealed loss or damage is discovered upon unpacking, make a written request for inspection by the carrier's agent within 15 days of delivery. All packing material should be kept for inspection. Do not return damaged merchandise to Lang Manufacturing Company. File your claim with the carrier.

Location

Prior to un-crating, move the range as near to its intended location as practical. The crating will help protect the unit from the physical damage normally associated with moving it through hallways and doorways.

Un-crating

Uncrate range as close to installation location as possible. The range is packaged on a pallet, wrapped in plastic to protect the unit from moisture and surrounded by a wooden frame. Remove the wood crating carefully. Improper use of tools can result in damage to the equipment. Remove and discard the plastic wrap. Desiccant bags on top of the range should also be discarded. Protective paper on top of the range may be left until the installation is complete. The range is raised on blocks to enable ease of handling when removing from the pallet with forklift or straps. Use extreme care regardless of method used and be aware of gravity center, especially with banks of multiple units.

PLEASE NOTE:

Legs, manuals, racks, rack slides, griddle cleaning tools, fryer smother covers and remote overhead switch boxes, where applicable, are packed inside the cabinet cavity and should remain there until the unit is at the final installation location. Desiccant bags have been placed inside electrical cavity and must be removed before operation.

INSTALLATION

DANGER

THIS APPLIANCE MUST BE GROUNDED AT THE TERMINAL PROVIDED. FAILURE TO GROUND THE APPLIANCE COULD RESULT IN ELECTROCUTION AND DEATH.



WARNING

INSTALLATION OF THE UNIT MUST BE DONE BY PERSONNEL QUALIFIED TO WORK WITH ELECTRICITY. IMPROPER INSTALLATION CAN CAUSE INJURY TO PERSONNEL AND/OR DAMAGE TO EQUIPMENT. UNIT MUST BE INSTALLED IN ACCORDANCE WITH ALL APPLICABLE CODES.



NOTICE

The data plate is located behind the access cover to the right of the oven door. The range voltage, wattage, serial number, wire size, and clearance specifications are on the data plate. This information should be carefully read and understood before proceeding with the installation.



NOTICE

The installation of any components such as a vent hood, grease extractors and fire extinguisher systems must conform to their applicable National, State and locally recognized installation standards.



Electrical Connection

Electrical connection can be hooked into the bottom front, below the terminal block, or at the right back of the unit behind the terminal block.

Range Voltage

The Lang Model CLCN36-H-S can be operated on 440 Volts.

INITIAL START-UP



Initial Start-Up

Before the initial use of the range, the range must be thoroughly allowed to dry itself out. Clean top plates thoroughly. Apply salad oil. Turn each plate thermostat to a low position and allow plate to heat for three hours. .

NOTICE **A moderate amount of smoke may issue from the range on initial start-up. Preservation and Manufacturing oils may be burning off as smoke. This is normal and not cause for alarm.**



OPERATION

<u>CAUTION</u>	ALWAYS KEEP THE AREA NEAR THE APPLIANCE FREE FROM COMBUSTIBLE MATERIALS.	
<u>CAUTION</u>	TO AVOID THE DANGER OF SLIPS OR FALLS, KEEP FLOOR IN FRONT OF EQUIPMENT CLEAN AND DRY. IF SPILLS OCCUR, CLEAN IMMEDIATELY.	

Range Controls

The hot top controls are, from front to back. The first set of knobs control the front left and right sections. The second set of knobs control the rear left and right sections. Each section has an 850°F thermostat.

WARNING

KEEP WATER AND SOLUTIONS OUT OF CONTROLS. NEVER SPRAY OR HOSE CONTROL CONSOLE, ELECTRICAL CONNECTIONS, ETC.

**CAUTION**

MOST CLEANERS ARE HARMFUL TO THE SKIN, EYES, MUCOUS MEMBRANES AND CLOTHING. PRECAUTIONS SHOULD BE TAKEN TO WEAR RUBBER GLOVES, GOGGLES OR FACE SHIELD AND PROTECTIVE CLOTHING. CAREFULLY READ THE WARNING AND FOLLOW THE DIRECTIONS ON THE LABEL OF THE CLEANER TO BE USED.

**After-Meal Cleaning**

Empty the grease drawer often or whenever it is 3/4 full. Remove the grease drawer after each meal and wash the inside and outside of the drawer.

Keep the hot top surface clean.

Clean the exterior of the appliance with a hot water and chlorine solution to maintain a gleaming appearance.

Be sure to rinse thoroughly and coat the cooking surface with a thin film of oil to prevent rusting.

Daily Cleaning

The range should be thoroughly cleaned at least once a day in addition to the normal after meal cleaning to insure against the accumulation of foreign material.

TROUBLESHOOTING

Symptoms

What follows is a chart of Symptoms and Possible Causes to aid in diagnosing faults with the oven.

Symptom	Possible Cause
Range will not heat	<ul style="list-style-type: none"> • Failed Transformer • Failed Power-switch • Failed Circuit Board / Heat Switch • Failed Probe • Failed Contactor • Failed Element • Open in terminal block
Product burning	<ul style="list-style-type: none"> • Product is cooked too long • Failed Circuit Board / Heat-switch • Failed Probe
Product under done	<ul style="list-style-type: none"> • Product is not cooked long enough • Failed Circuit Board / Heat-switch • Failed Probe

NOTICE

Service on this, or any other, LANG appliance must be performed by qualified personnel only. Consult your authorized service station directory or call the factory at 1-800-224-LANG (5264), or WWW.LANGWORLD.COM for the service station nearest you.



Tests

If an item on the list is followed by an asterisk (*), the work should be done by a factory authorized service representative.

Possible Cause	Test
Product is not cooked enough	<ul style="list-style-type: none"> • No test available, operational condition
Product is cooked too long	<ul style="list-style-type: none"> • No test available, operational condition
Failed Transformer	<ul style="list-style-type: none"> • Check transformer primary and secondary coils for continuity*
Failed Power –switch	<ul style="list-style-type: none"> • Check power switch for normal operation
Failed Circuit Board	<ul style="list-style-type: none"> • Confirm that Circuit board is getting 24 Volts input and 24 Volts output*
Failed Probe	<ul style="list-style-type: none"> • Check probe for proper resistance*
Failed Contactor	<ul style="list-style-type: none"> • Confirm that Contactor has 24 Volts to the coil and that contactor point move
Failed Element	<ul style="list-style-type: none"> • Check Element for proper continuity.

CAUTION

USE OF ANY REPLACEMENT PARTS OTHER THAN THOSE SUPPLIED BY LANG OR THEIR AUTHORIZED DISTRIBUTORS CAN CAUSE BODILY INJURY TO THE OPERATOR AND DAMAGE TO THE EQUIPMENT AND WILL VOID ALL WARRANTIES.



PARTS LIST

CLCN36R-H-S

Item #	Description	Part Number
1	Body	CLR-004-1
2	Vent Back	CLR-529
3	Chrome Plated Hot Top	50403-22-1
4	Can Assembly	CLB-700
5	Cabinet Base, Switch Panel	CLB-531-1
6	T-stat 850°	30302-23
7	Knob	70701-28
8	2 Pole Contactor, 125 Amp	30500-11
9	Element Plate Spacer	CLR-514
10	Element Plate Support	CLR-512
11	Element Plate	CLR-511
12	Outer Element, 440 Volt, 1650 Watt	11045-08
13	Inner Element, 440 Volt, 1850 Watt	11045-09
14	Element Pan	CLR-513
15	Shiprail Assembly	CLR-310
16	Insulation Kit	60106-45
17	Wire Harness, Hot Plate	CLR-565

EXPLODED VIEW

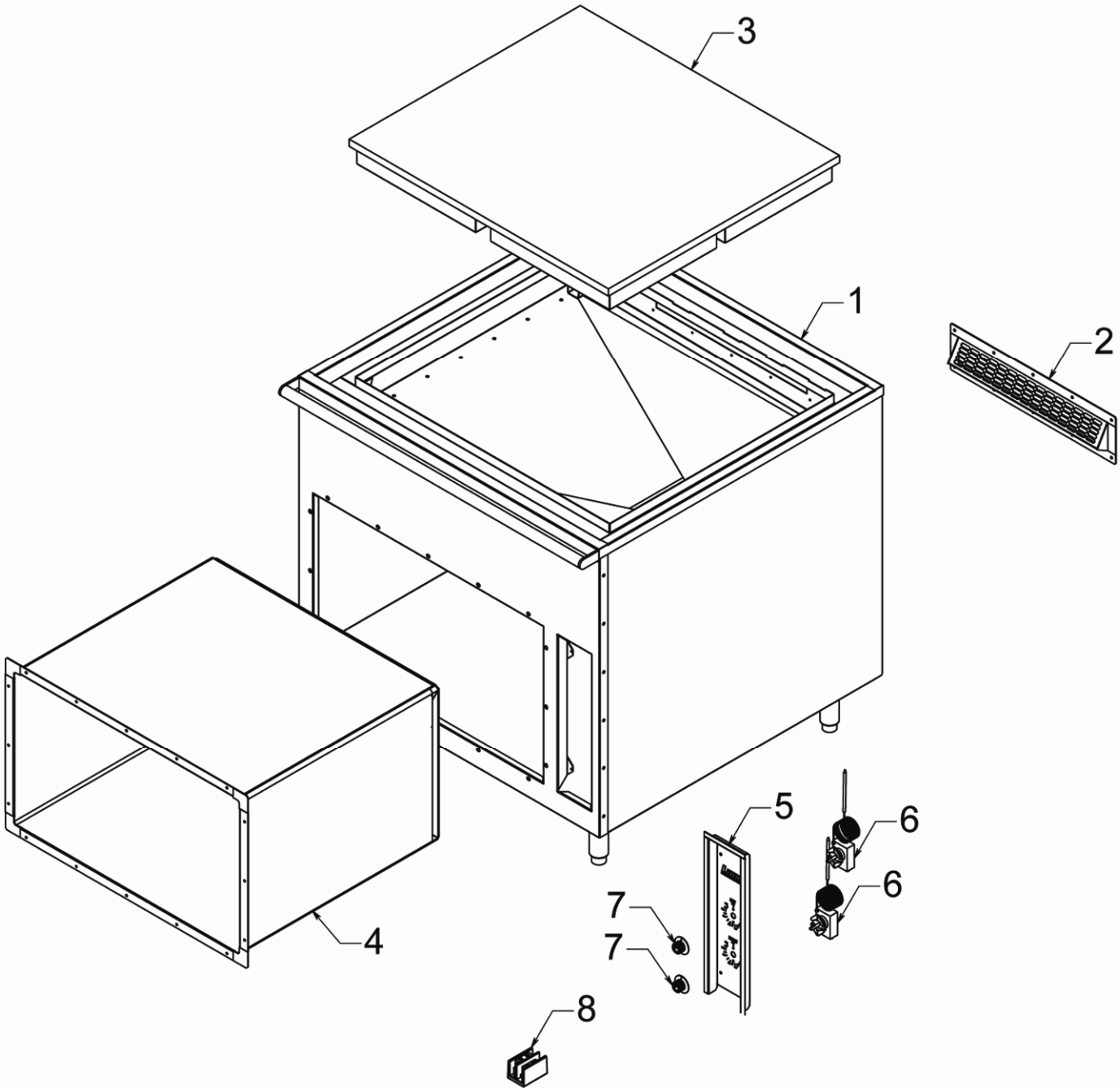

EXPLODED VIEW Cont'd

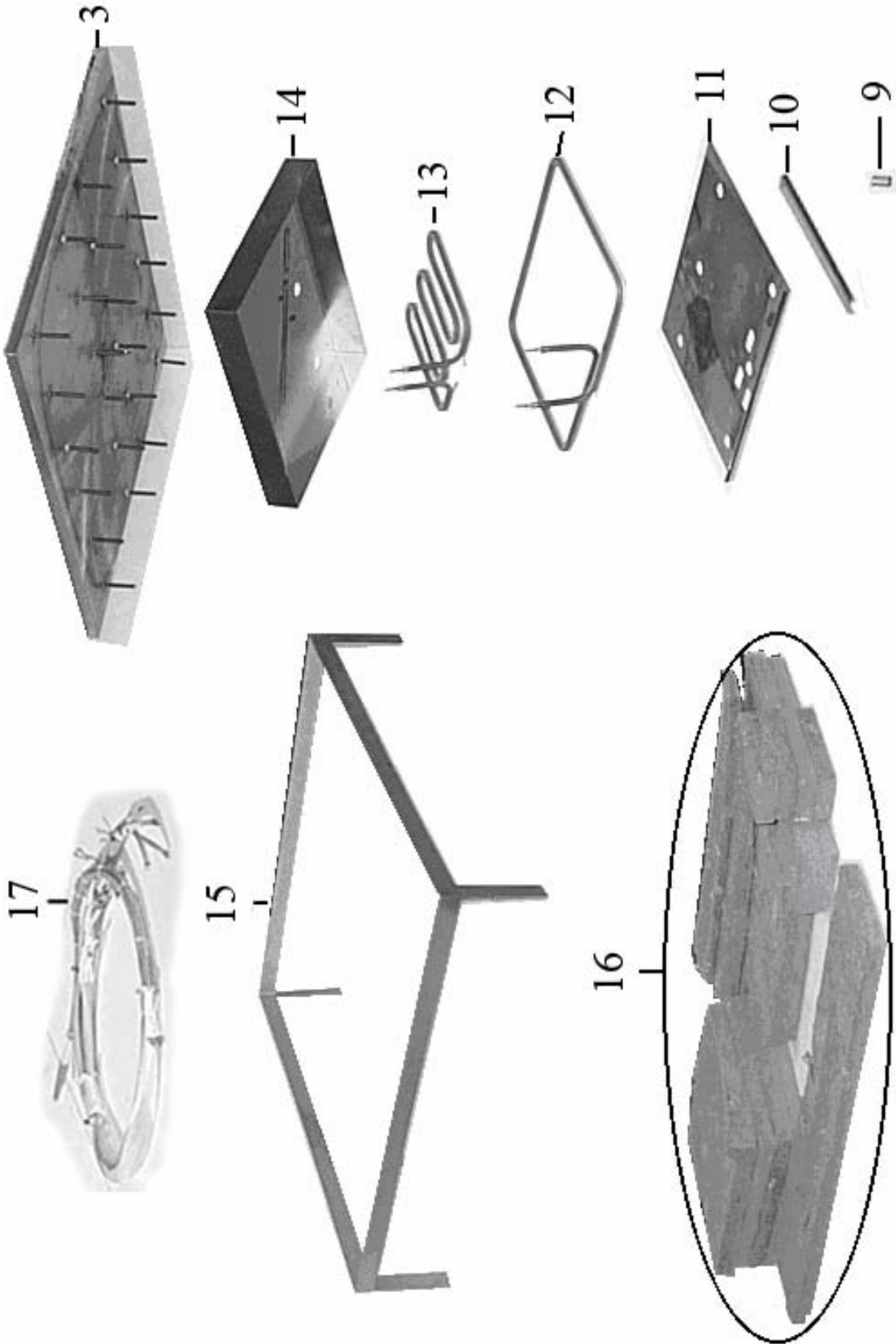

WIRING DIAGRAM

KILOWATTS		440 VOLT			THREE PHASE		
L1-L2	L2-L3	L3-L1	TOTAL	L1	L2	L3	L3
7	0	7	14	31.9	15.9	15.9	3-6

