

Installation, Operation, & Maintenance

IOM 7202
Rev. A 12/23

COOL PAK AC (ECE) SPACE CONSTRAINED AIR CONDITIONERS WITH ELECTRIC HEAT

ecoseries
COOL-PAK

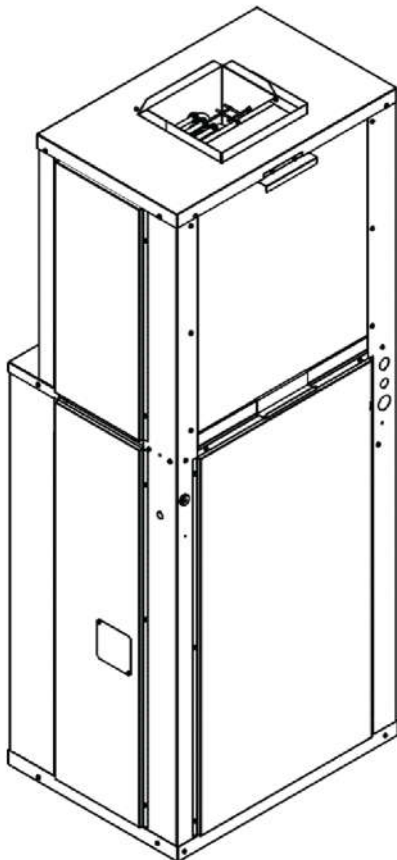

ATTENTION:

Read all instructions thoroughly and retain all manuals for future reference.



COPYRIGHT

The Manufacturer works to continually improve its products and as a result, it reserves the right to change design and specifications without notice.

The warranty may be void unless the Startup & Performance Checklist is completed and returned to the warrantor. If the COOL-PAK AC unit is not installed properly the warranty will be void as the manufacturer cannot be held accountable for problems that stem from improper installation.

******WARNING TO INSTALLER, SERVICE PERSONNEL AND OWNER******

Altering the product or replacing parts with non-authorized factory parts voids all warranty or implied warranty and may result in adverse operational performance and/or a possible hazardous condition to service personnel and occupants. Company employees and/or contractors are not authorized to waive this warning.

TABLE OF CONTENTS

SAFETY CONSIDERATIONS	4
MODEL NOMENCLATURE	5
GENERAL INFORMATION	6
UNIT OPERATION	6
STORAGE	6
UNIT INSPECTION CHECKLIST	7
ECE UNIT DIMENSIONAL DATA	8
UNIT PHYSICAL DATA	9
ELECTRICAL DATA	10
INSTALLATION	11-16
INSTALLATION PRECAUTIONS	11
UNIT LOCATION	12
UNIT CLEARANCE REQUIREMENTS	12
WALL SLEEVE INSTALLATION	13
PACKAGED UNIT INSTALLATION	14
DUCTWORK	15
FRESH AIR VENT	15
CONDENSATE DRAIN	16
ELECTRICAL	17
HIGH VOLTAGE	17
208 VOLT OPERATION	17
THERMOSTAT REQUIREMENTS	17
THERMOSTAT INSTALLATION	17
CONTROLS	18-19
ECO-SERIES CONTROL MODULE	18
COOLING OPERATION	19
AUXILLARY HEATING OPERATION	19
BLOWER DATA	20
ECE BLOWER DATA	20
WIRING DIAGRAMS	21-24
STARTUP INSTRUCTIONS	25
PRE-STARTUP CHECKS	25
PRIOR TO THE STARTUP OF THE UNIT	25
COOL-PAK AC UNITS	25
STARTUP & PERFORMANCE CHECKLIST INSTRUCTIONS	25
TROUBLESHOOTING	26-27
MAINTENANCE & SERVICE	28
PREVENTIVE MAINTENANCE	28
STARTUP & PERFORMANCE CHECKLIST	29
NOTES	30

SAFETY CONSIDERATIONS

1. **READ THE ENTIRE MANUAL BEFORE STARTING THE INSTALLATION.**
2. These instructions are intended as a general guide and do not supersede national, state, or local codes in any way.
3. Altering the product, improper installation, or the use of unauthorized factory parts voids all warranty or implied warranty and may result in adverse operation and/or performance or may result in hazardous conditions to service personnel and occupants. Company employees or contractors are not authorized to waive this warning.
4. This product should only be installed and serviced by a qualified, licensed, and factory authorized installer or service agency.
5. All “kits”, parts, and “accessories” used must be factory authorized when modifying this product. Refer and follow instructions packaged with the kits or accessories when installing.

RECOGNIZE THE FOLLOWING SAFETY NOTATIONS THROUGHOUT THIS MANUAL AND POSTED ON THE EQUIPMENT:

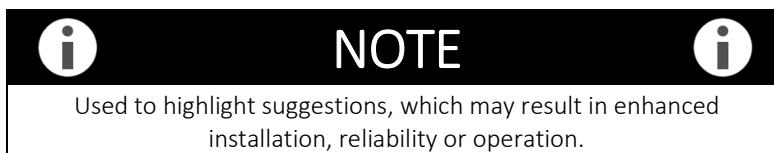

MODEL NOMENCLATURE

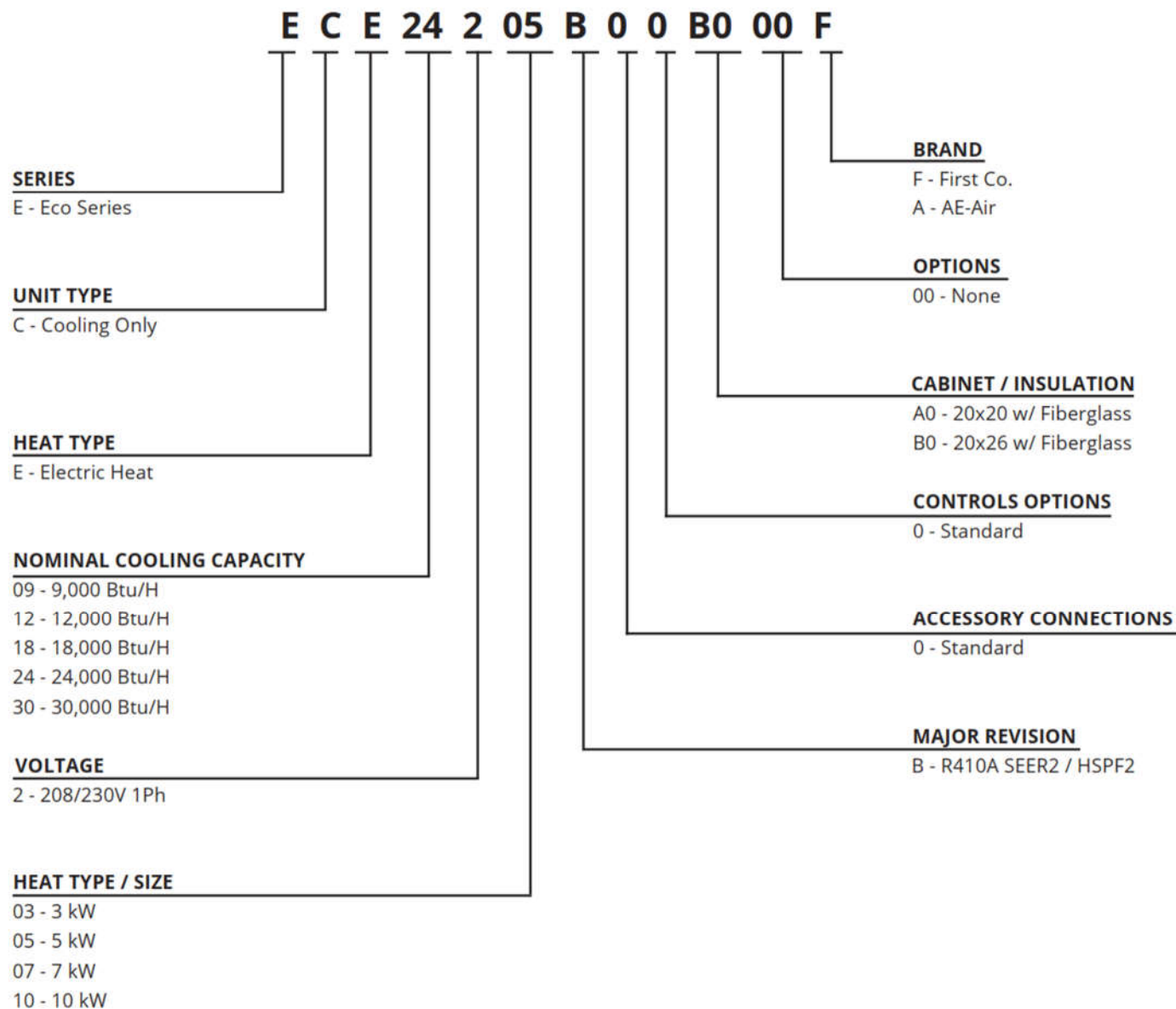







Figure 1 - Model Nomenclature



GENERAL INFORMATION

The Eco-series COOL-PAK AC models are a space constrained package air-conditioning unit with integrated electric heat or hot water. The unit is tested to AHRI 210/240 2023 and is in compliance with UL 1995 Rev 5.

These instructions are given for the installation of the Eco Series COOL-PAK AC specifically. For any other related equipment, refer to the appropriate manufacturer's instructions.

 CAUTION 	
DO NOT use units during any phase of construction.	
Mechanical components and filters can become clogged with dirt and debris, which can cause damage to the system.	
The manufacture does not warrant equipment subjected to abuse. Construction debris can void warranties and liability for equipment failure, personal injury, and property damage.	

 WARNING 	
 ELECTRIC SHOCK HAZARD 	
ALWAYS turn off all power to the unit before servicing equipment. There may be more than one disconnect switch. All lockout/tag out procedures should be followed.	
Electrical shock can cause personal injury or death.	

 NOTE 	
Material in this shipment has been inspected at the factory and released to the transportation agency in good condition.	
Upon receipt, a visual inspection of all cartons should be made immediately. Any evidence of rough handling or apparent damage should be noted on the delivery receipt in the presence of the carrier's representative.	
If damage is found, a claim should be immediately filed against the carrier.	

 CAUTION 	
Extreme caution must be taken to ensure that no internal damage will result from screws that are drilled into the cabinet.	

UNIT OPERATION

Unit Operating Range °F [°C]		
Condition	Cooling	
	Min	Max
Outdoor DB	60 [15.6]	115 [46.1]
Indoor DB	60 [15.6]	90 [32.2]



Table 1 – Unit Operating Range

Note:

- 1) Operating ranges based off standard installation with "0" external static and standard Louvers. Operation with non-standard louvers may lower unit operating range.

STORAGE

Equipment should be stored in a clean dry, conditioned area with maximum temperatures up to 120°F [48.89°C] and minimum temperatures to 32°F [0°C]. Units should be stored upright and in an indoor environment. It is recommended to leave packaging on the unit until the installation is to begin.

 WARNING 	
Stacking the COOL-PAK systems is strictly prohibited. Failure to follow this directive may result in system and/or property damage.	

DO NOT operate units during the construction process. Mechanical components and filters could become clogged with dirt and debris, which can cause damage to the system.

The manufacture does not warrant equipment subjected to abuse. Construction debris can void warranties and liability for equipment failure, personal injury, and property damage.

UNIT INSPECTION CHECKLIST

Before preparing unit for installation, complete the inspection procedures below.

- 1) Visually inspect unit for any shipping damage. Damage must be reported immediately to the shipping company to make a claim.
- 2) Ensure that the carrier makes proper notation of any shortages or damage on all copies of the freight bill and completes a common carrier inspection report.
- 3) Verify that unit nameplates on the data label match the sales order or bill of lading (including, unit configuration, size and voltage).
- 4) Immediately before installation, remove unit front panel and verify that all electrical connections are tight and that there are no loose wires.
- 5) Verify that the refrigerant piping is free from any kinks and there is no interference between unit piping and sheet metal or electrical wires.
- 6) Remove the blower access panel and remove the Styrofoam packaging mount underneath the blower.
- 7) Check that the blower spins freely within the housing and there are no obstructions between the wheel and housing. The wheel can sometimes come loose in shipping.
- 8) Ensure that evaporator distributor tubes are not touching one another and that they are over the drain pan.
- 9) Check the air-coil fins for any damage during shipping.
- 10) Ensure that shipping brackets and screws are removed from condensing section. Refer to Figure 2 - Shipping Bracket Removal



NOTE



Check the unit nameplate for correct voltage with the plans before installing the equipment.

Ensure that all electrical ground, connections are made in accordance with local code.



NOTE



Remove the Styrofoam shipping block supporting the blower assembly.

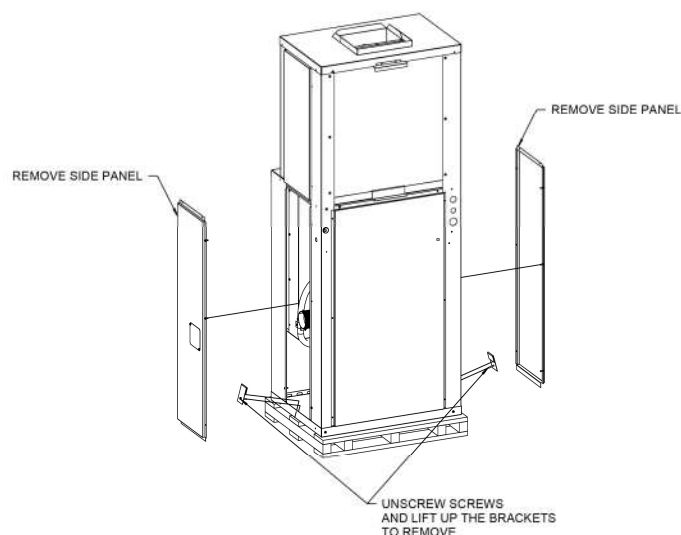
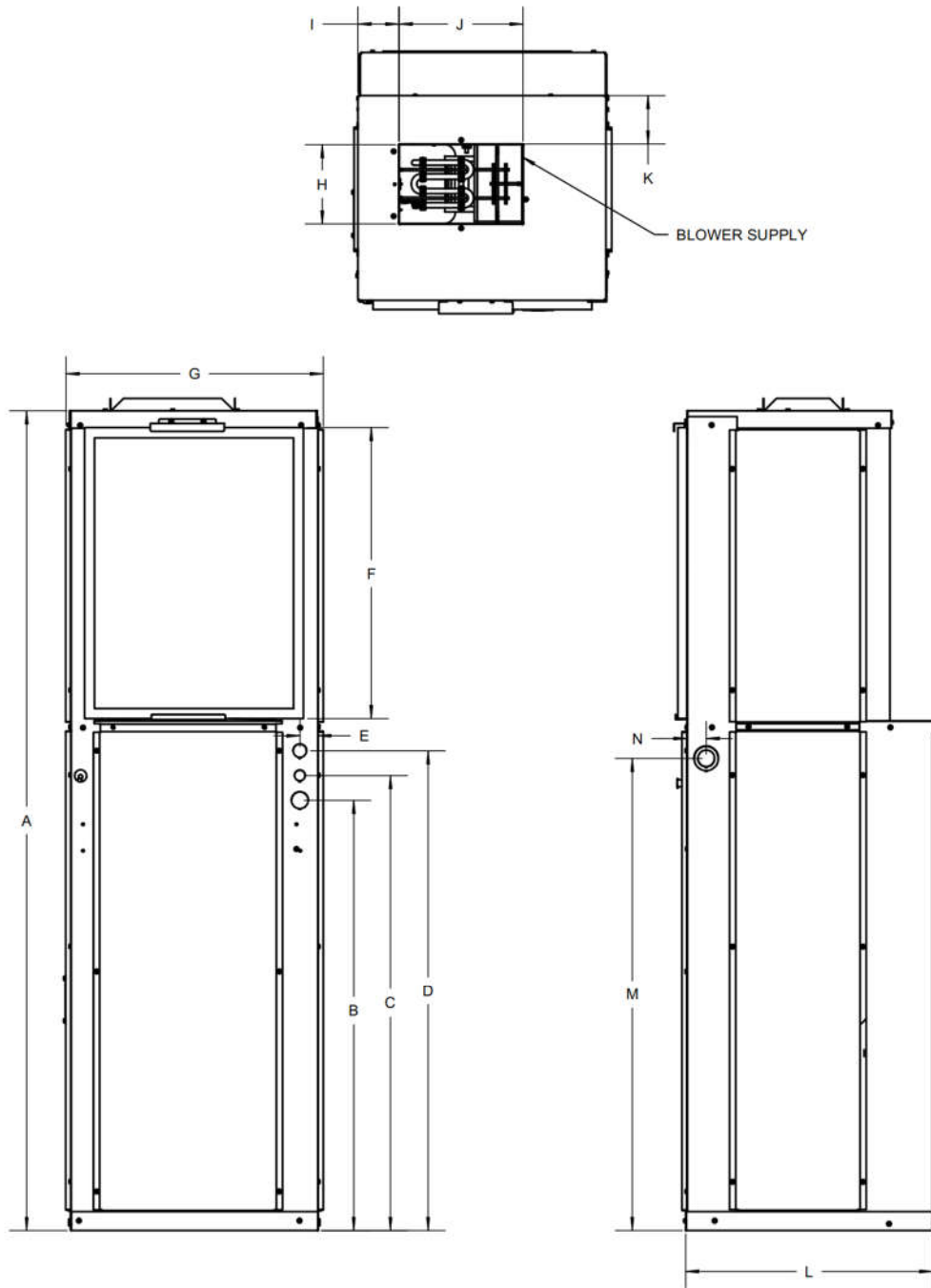

Figure 2 - Shipping Bracket Removal

ECE UNIT DIMENSIONAL DATA



DIMENSIONAL DATA														
MODEL	A	B	C	D	E	F	G	H	I	J	K	L	M	N
	CABINET DIMENSIONS							SUPPLY CONNECTIONS						
ECE09	66.5	34.9	36.9	38.9	1.4	23.6	20.9	6.4	3.3	10.0	3.9	20.1	38.2	1.6
ECE12	66.5	34.9	36.9	38.9	1.4	23.6	20.9	6.4	3.3	10.0	3.9	20.1	38.2	1.6
ECE18	66.5	34.9	36.9	38.9	1.4	23.6	20.9	6.4	3.3	10.0	3.9	20.1	38.2	1.6
ECE24	66.5	34.9	36.9	38.9	1.4	23.7	26.9	10.0	7.9	10.0	3.9	20.1	38.2	1.6
ECE30	66.5	34.9	36.9	38.9	1.4	23.7	26.9	10.0	7.9	10.0	3.9	20.1	38.2	1.6

Table 2 – ECE Dimensional Data

UNIT PHYSICAL DATA

PHYSICAL DATA					
COOL-PAK Model	ECE092**B	ECE122**B	ECE182**B	ECE242**B	ECE302**B
Compressor (Quantity)	Rotary (1)			Scroll (1)	
Factory Charge (R410A) lb. [kg]	3.4 [1.53]	4.1 [1.85]	5.2 [2.36]	5.3 [2.39]	5.5 [2.48]
ID MOTOR					
Motor (Quantity)	1	1	1	1	1
Fan Motor Type	ECM	ECM	ECM	ECM	ECM
Motor HP	1/4	1/4	1/3	1/3	1/2
OD MOTOR					
Motor (Quantity)	1	1	1	1	1
Fan Motor Type	ECM	ECM	ECM	ECM	ECM
Motor HP	1/4	1/4	1/4	1/4	1/3
ID BLOWER					
Blowers (Quantity)	1	1	1	1	1
Blower Wheel Size (D x W) in. [cm]	6 x 4 [15.2 x 10.16]	6 x 4 15.2 x 10.16]	10 x 4 [25.4 x 10.16]	10 x 4 [25.4 x 10.16]	10 x 4 [25.4 x 10.16]
EVAPORATOR COIL					
Dimensions (H x W) in. [cm]	24 x 16 [61 x 41]	24 x 16 [61 x 41]	24 x 16 [61 x 41]	24 x 22 [61 x 56]	24 x 22 [61 x 56]
Face Area ft ² [m ²]	2.6 [0.24]	2.6 [0.24]	2.6 [0.24]	3.6 [0.33]	3.6 [0.33]
Rows	2	3	4	4	4
OD COIL					
Dimensions (H x W) in. [cm]	26 x 16.5 [66 x 42]	26 x 16.5 [66 x 42]	26 x 16.5 [66 x 42]	26 x 22.5 [66 x 57]	26 x 22.5 [66 x 57]
Face Area ft ² [m ²]	2.9 [0.27]	2.9 [0.27]	2.9 [0.27]	4.1 [0.38]	4.1 [0.38]
MISCELLANEOUS					
Throwaway Filter Dim. in. [cm]	24 x 24 [61 x 61]	24 x 24 [61 x 61]	24 x 24 [61 x 61]	24 x 24 [61 x 61]	24 x 24 [61 x 61]
Throwaway Filter Quantity	1	1	1	1	1
Operating Weight lb. [kg]	288 [131]	289 [131]	290 [131]	305 [138]	315 [142]
Packaged Weight lb. [kg]	310 [141]	310 [141]	310 [141]	325 [147]	335 [152]

Table 3 – ECE, PHYSICAL DATA

ELECTRICAL DATA

ECE ELECTRICAL DATA (208/230-1PH-60HZ)										
Model Number	COMPRESSOR		OUTDOOR MOTOR		INDOOR MOTOR		MIN. CIRCUIT AMPACITY (MCA)		MAX. OVERCURRENT PROTECTION (MOP)	
	RLA	LRA	FLA	HP	FLA	HP	CIRCUIT 1 (L1-L2)		CIRCUIT 1 (L1-L2)	
							240V	208V	240V	208V
ECE09203B	4.4	20	2.3	1/4	2.3	1/4	16.4	18.5	20	20
ECE12200B	4.7	26	2.3	1/4	2.3	1/4	11.6	11.6	15	15
ECE12203B	4.7	26	2.3	1/4	2.8	1/3	17.0	19.1	15	20
ECE12205B	4.7	26	2.3	1/4	2.8	1/3	23.8	26.9	25	30
ECE18200B	9	56	2.3	1/4	2.8	1/3	17.6	17.6	25	25
ECE18203B	9	56	2.3	1/4	2.8	1/3	17.6	19.1	25	25
ECE18205B	9	56	2.3	1/4	2.8	1/3	26.0	29.5	30	30
ECE18207B	9	56	2.3	1/4	2.8	1/3	35.1	40.0	40	40
ECE18210B	9	56	2.3	1/4	2.8	1/3	48.6	55.6	50	60
ECE24200B	10.1	62	2.3	1/4	2.8	1/3	19.0	19.0	25	25
ECE24205B	10.1	62	2.3	1/4	2.8	1/3	26.0	29.5	25	30
ECE24207B	10.1	62	2.3	1/4	2.8	1/3	35.1	40.0	40	40
ECE24210B	10.1	62	2.3	1/4	2.8	1/3	48.6	55.6	50	60
ECE30200B	12.8	65	2.8	1/3	2.8	1/3	23.0	23.0	30	30
ECE30205B	12.8	65	2.8	1/3	4.1	1/2	27.7	31.2	35	35
ECE30207B	12.8	65	2.8	1/3	4.1	1/2	36.7	41.6	40	45
ECE30210B	12.8	65	2.8	1/3	4.1	1/2	50.2	57.2	50	60

Table 4– ECE Electrical Data Table

Notes

- 1) All ECE and models use single point power for unit operation
- 2) Refer to wiring diagrams in the ECE IOM for additional details
- 3) Wire size should be determined in accordance with National Electric Codes
- 4) Unit are rated for 208/230V, but MOP, MCA values are calculated at 208/240V
- 5) For all models, Minimum voltage is 197V. Maximum voltage is 252V

INSTALLATION

INSTALLATION PRECAUTIONS

CAUTION

Always wear all appropriate personal protection Equipment when installing and servicing units.

WARNING

Use multiple people to team lift when moving and installing these units. Failure to properly lift units may result in personal injury or death.

CAUTION

Contact with metal edges and corners can result in personal injury. Protective gloves should be worn when handling. Exercise caution when installing and servicing unit.

Observe the following precautions for typical installation.

- Always use proper tools and equipment
- No wiring or any work should be attempted without first ensuring the unit is completely disconnected from the power source and locked out. Also, verify that a proper permanent and uninterrupted, ground connection exists prior to energizing power to the unit.
- Review unit nameplate and wiring diagram for proper voltage and control configurations. This information may vary from unit to unit.
- Units must be installed leveled to ensure proper drainage and operation.
- Be sure that the drain pan is free from foreign material prior to start up.

CAUTION

Components rotate at high speeds when the unit is in operation.

- Check filter media installation to ensure that it is installed correctly. Use the directional arrows or other information on the filter to determine the proper flow direction.
- Ensure air distribution system does not exceed the external static rating of the unit.

WARNING

When soldering and brazing, it is recommended that fire extinguishers be available. When soldering and brazing close to valves or sensitive components, heat shields or wet rags are required to prevent damage to the valves or components.

NOTE

Insulation is installed in the unit to provide a barrier between varying atmospheres outside and within the unit. If insulation is damaged condensation can occur and can lead to corrosion, component failure, and possible property damage. Damaged insulation must be repaired prior to the operation of the unit. Insulation will lose its effectiveness and value when wet, torn, separated, and/or damaged.

CAUTION

When servicing this equipment, ensure that the expansion device, filter drier and other components are specifically designed for R-410A refrigerant.

ONLY USE service equipment specifically designated for use with R-410A.

WARNING

R-410A can become combustible if mixed with air at elevated temperature and/or pressure.

Failure to observe this warning may result in property damage, personal injury, or death.

INSTALLATION (continued)

UNIT LOCATION

The COOL-PAK AC is designed for through-the-wall installation. The interior portion of the unit is surrounded by a closet with a rear access **Figure 5**. The vertical discharge allows for ducting to the top of the room for best air circulation and elimination of cold drafts on occupants.

Provisions should be made to allow access to the indoor side of the unit for installation and inspection. The closet or access panel opening must be centered with the exterior wall opening and must be large enough to accommodate the installation of the Cool-pak Sleeves.

3-in. of unobstructed clearance must be maintained around the COOL-PAK AC chassis on all sides for adequate airflow to achieve optimum performance. These guidelines give minimum spacing requirements only. It is acceptable to go beyond these limits at any time. At least 27 in. of unobstructed space should be provided in front of the access door to permit removal of the unit, should repair and inspection be required.

The installer must adhere strictly to all local and national code requirements pertaining to the installation of this equipment. All units are designed for indoor use only, and are agency listed for installation with clearances specified in **Table 5 - Clearance Requirements**. This includes the cabinet, discharge plenum and connecting ducts.

UNIT CLEARANCE REQUIREMENTS

Service clearance must be provided for future maintenance and service. A minimum of 29 in. [73.66 cm] open area must be left unobstructed in front of the access panels.

The louver side must be kept free from any obstructions to air flow. The unit must be installed at least 4 feet [1.22m] from electric meters, gas meters, regulators, and relief equipment.

CLEARANCE REQUIREMENTS		
MINIMUM CLEARANCE	INCHES	CM
Horizontal distance between units	12	30
Vertical distance between units	60	152
Distance above ground level	6	15
Distance above finished floor	6	15
Distance above a garage floor	18	46

Table 5 - Clearance Requirements

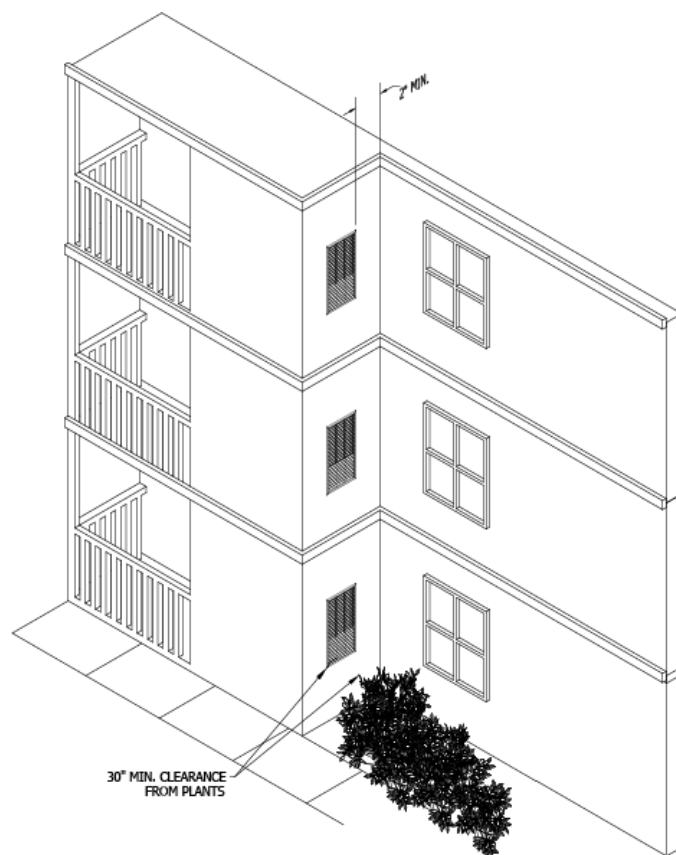

Figure 3 - Clearance Requirements



NOTE



Do not locate two units adjacent to each other on an inside corner or where they may exhaust into each other.



NOTE



The COOL-PAK units are designed for quiet operation. However, all air conditioning equipment will transfer a level of noise to the conditioned space.

This should be considered when planning the location of the equipment.



NOTE



The Architectural Louver must be installed prior to the installation of the COOL-PAK AC unit into the sleeve.

INSTALLATION (continued)

WALL SLEEVE INSTALLATION

Refer to installation instruction packed with the wall sleeve to assemble and mount into the wall. Before unit installation, verify that sleeve components are not damaged and that the drain line is unobstructed free of leaks.

Check all seals to ensure that they are in position and un-damaged. Ensure that the wall sleeve is sloped toward the exterior of the building. Securely fasten the Architectural louver to the front of the sleeve using the supplied hardware.

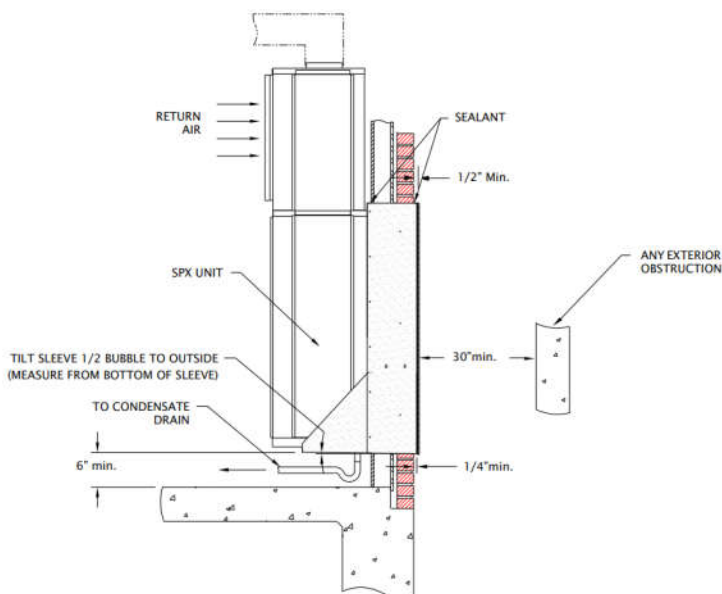

Figure 4 – Wall Sleeve Mounting

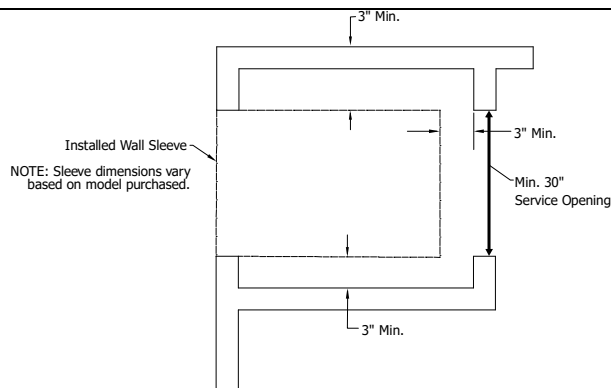

Figure 5 - Rear Sleeve Installation

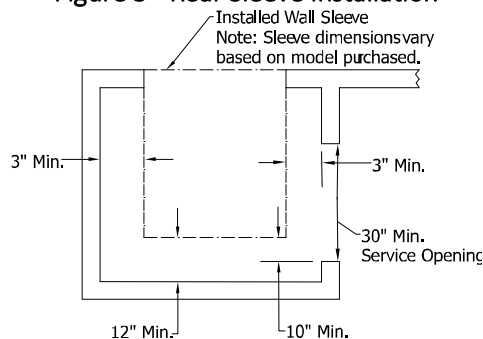

Figure 6 - Side Sleeve Installation

- “A” Cabinet Sleeve rough-in opening is 43-1/2 in. (H) [110.49 cm] x 26-3/4 in. (W) [67.94 cm].
- “B” Cabinet Sleeve rough-in opening is 43-1/2 in. (H) [110.49 cm] x 26-3/4 in. (W) [67.94 cm].
- Bottom of opening should be approximately 6 in. [15.24 cm] above the floor.

IMPORTANT

After sleeve installation, ensure that the gap in-between the wall and seal is insulated and is in contact with the sleeve sides.

IMPORTANT

Apply a high grade non-hardening sealant approved for exterior at the following locations to prevent air and water from migrating inside:

1. Between edge of the sleeve and the structure
2. On the inside/outside walls.

IMPORTANT

Units are ONLY intended for indoor installation applications.

IMPORTANT

Sleeve should be installed in exterior wall prior to constructing closet

NOTE

Additional insulation is required on the internal condensate connections whenever the unit is operated in an area subject to freezing temperatures.

NOTE

Locate the unit in an area that provides minimum clearance to all service access panels. Consider all additional clearances needed for water connections, electrical connections, duct connections and sufficient return airflow.

INSTALLATION (continued)

PACKAGED UNIT INSTALLATION

- 1) Before installing the unit in the sleeve be sure to go through the unit inspection check-list
- 2) Open the rear access door to grab loose items such as a electrical disconnect.
- 3) Ensure that properly sized ductwork is in place to mate to the connections on the Cool-pak.
- 4) Ensure that the wall sleeve is installed correctly into the wall and is secured before installing unit. Also ensure that the sleeve has the proper slope towards the exterior of the building.
- 5) After removing the construction debris guard, check the bottom of the sleeve pan to ensure that it is sloped toward the building exterior. Ensure that the bottom of the pan and drain are clear of obstruction and are operational.
- 6) Slide the unit on to the sleeve and push from the bottom until the front of the unit is aligned with the front of the sleeve.
- 7) Inspect the sleeve seal to ensure that it is properly secured and aligned. . Use a high-grade non-hardening sealant to close any gaps that may exist between the seal and the wall of the sleeve.
- 8) Check that the unit is completely settled on all four sides against the wall sleeve and seals.

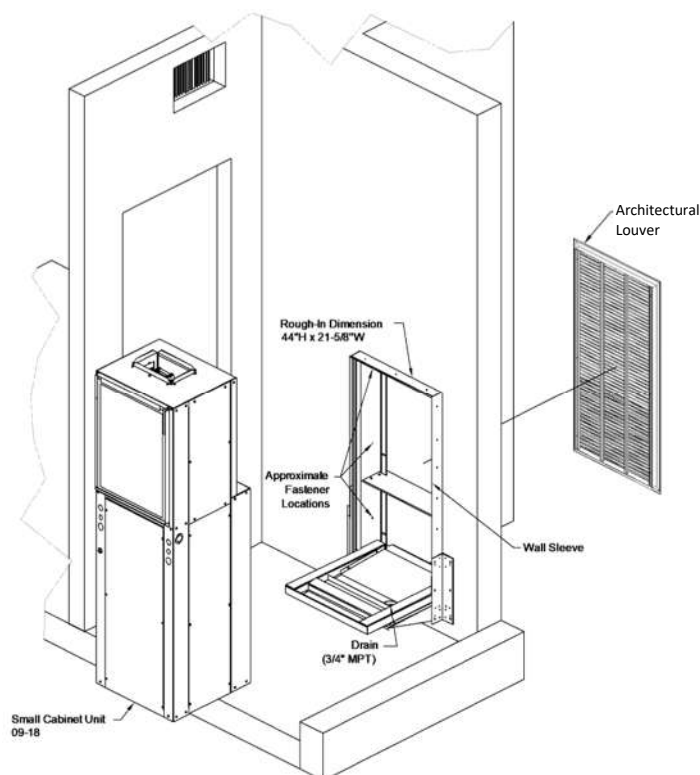

Figure 7 - Small Cabinet Installation

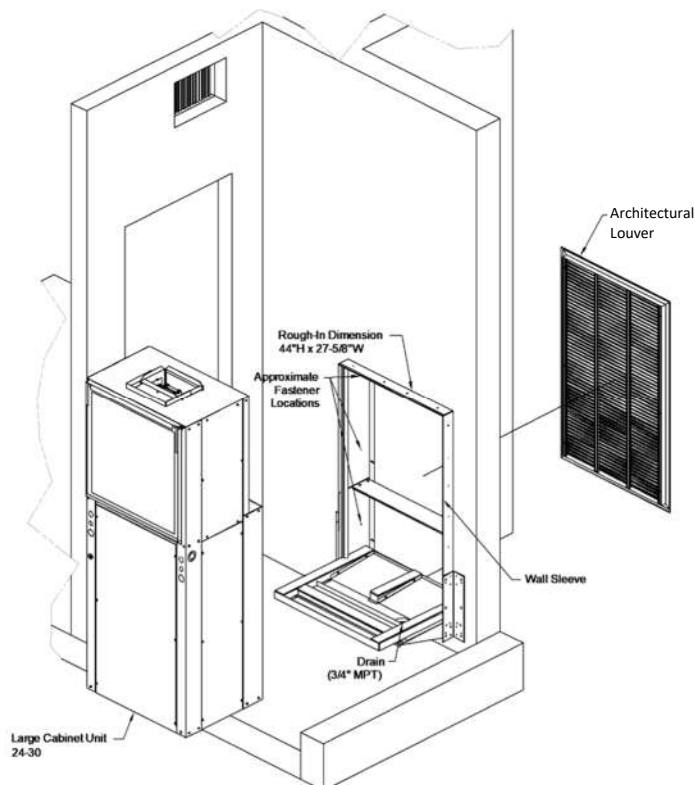

Figure 8 - Large Cabinet Installation



NOTE



The unit is fully engaged in the sleeve if the top sleeve is in contact with the blower section of the unit. The condensing section should sit 3.5" deep into the sleeve.



CAUTION



If unit is not sealed properly, water and/or outside air will infiltrate the closet which may cause improper unit operation and can cause damage to the unit and/or property.

INSTALLATION (continued)

DUCTWORK

Discharge ductwork is normally used with these units. When return air ductwork is required, the unit is supplied with 1 in. [5.08 cm] thick filter rack/duct collar for connection of return air ductwork. All ductwork must be installed in accordance with National Fire Protection Assoc. Codes 90A and 90B.

Supply and Return ducts must be sized properly as to not exceed static pressure capabilities of the unit. Ducts should be adequately insulated to prevent condensation and to minimize heat loss. A flexible connector is recommended for supply air connections on metal duct systems.

DISCHARGE DUCTING

All Ductwork must conform to industry standards of good practice as described in ASHRAE System Guide. The transition piece from the unit discharge to the duct distribution system must not have an angle greater than 30° or severe loss of air performance can result.

Do not connect the full duct size to the unit discharge collar without using a transition piece down to the size of the unit discharge collar. With metal material, the sides of the elbow and entire branch duct should be internally lined with acoustic insulation for sound attenuation.

The ductwork should be configured such that there is no line of sight between the unit discharge and the distribution diffusers.

RETURN AIR DUCTING

Return air duct can be brought in through a wall louver and then to the unit. The return duct system will normally consist of flexible connector at the unit and a trunk duct to the return air louver. With metal duct material, the return air duct should be internally lined with acoustic insulation for sound attenuation. A 1 in. [5.08 cm] air duct collar flange is included on the filter rack for ducted return air application. A flexible duct collar can then be attached between a duct transition and the return air ductwork. The return air duct transition must be the same size as the return air coil face area. Be sure to allow for proper clearance to allow for filter change outs.

AIR FILTER

All indoor return air must be filtered. The preferred methods are listed below.

1. Use the factory supplied filter kit which attaches to the inlet of the evaporator.
2. Use the filter kit supplied with the access panel which accepts an 24 in. [60.96 cm] x 24 in. [60.96 cm] x 1 in. [2.54 cm] throwaway type of filter.
3. Any field installation of an air filter, means must be provided, for use of a disposable filter which is no smaller than the face area of the evaporator coil.

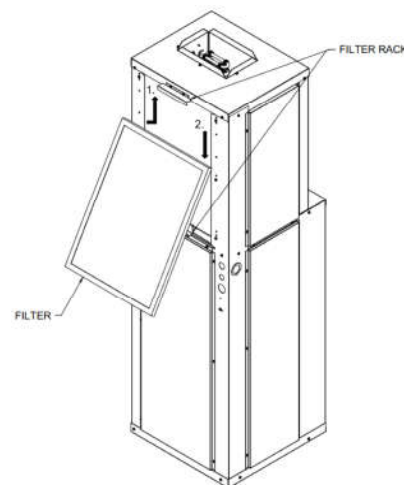

Figure 9 - Air Filter Installation

FRESH AIR VENT

The COOL-PAK units come standard with an optional fresh-air vent that can be used to provide ventilation to the condition space.

If the panel is removed, the condenser fan pushes outdoor air into the indoor space. The amount of conditioned air depends on the unit size and cannot be adjusted.

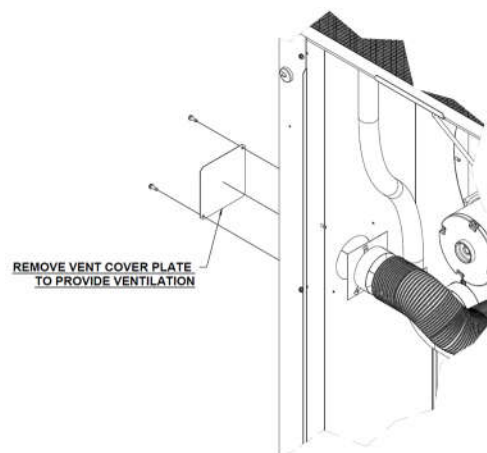

Figure 10 - Fresh Air Vent

CONDENSATE DRAIN

The COOL-PAK is designed so that the wall sleeve is the principle drain pan. Drain tubing is factory installed which drains evaporator condensate through the bottom of the unit which then is allowed to drain into the wall sleeve pan.

Condensate drain lines must be installed with adequate slope to ensure positive drainage. Prior to unit installation ensure that the drain is unobstructed and leak free.



CAUTION



On units with plastic drain pans, the drain connection must be made hand tight only.

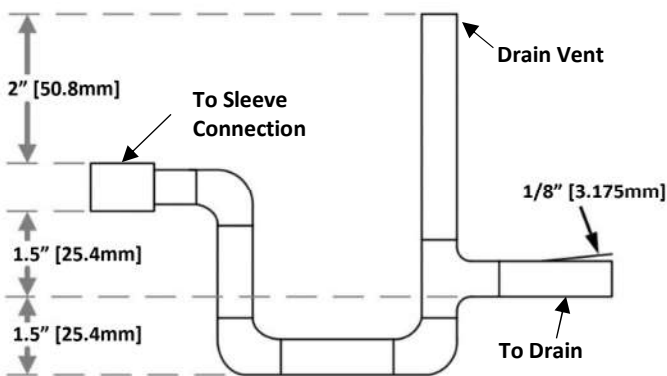

Figure 11 - Condensate Drain



NOTE









While preparing unit for installation, ensure that the drain tubing from the evaporator is securely attached to the copper nipple in the pan under the compressor. The wall sleeve has a 3/4 in. NPT nipple located in the bottom for connection to a drain. A trap is required in the condensate drain line from the wall sleeve to prevent sewer gas from escaping into the room.

ELECTRICAL



HIGH VOLTAGE



All wiring must comply with local and national code requirements. Units are provided with wiring diagrams and nameplate data to provide information required for necessary field wiring.

	WARNING	
	ELECTRIC SHOCK HAZARD	
Disconnect all power supplies before servicing. Lock out/tag out to prevent accidental electrical shock.		
NOTE: There may be multiple power sources supplying the unit.		

	WARNING	
Use copper conductors only. Install all parts and panels before operation of unit. Failure to follow these warnings can result in personal injury or death.		

Units are provided with a class 2 transformer for 24VAC control circuits. Should any add-on accessory or component also have a class 2 transformer furnished, care must be taken to prevent interconnecting outputs of the two transformers by using a thermostat with isolating contacts.

	WARNING	
Connect ground wire to ground terminal marked "GND". Failure to properly ground the unit may result in personal injury or death.		

	CAUTION	
Any device that has been furnished by the factory for field installation must be wired in strict accordance with the associated wiring diagram. Failure to properly wire the unit may damage components and void warranties.		

208 VOLT OPERATION

All 208-240 Volt units are factory wired for 240 Volt operation. For 208 Volt operation, moving, changing, or rewiring the line voltage tap on the 24 Volt control transformer is required. See note on unit wiring diagram for instructions.

THERMOSTAT REQUIREMENTS

A minimum of a 1C/1H thermostat is required to operate the COOL-PAK AC. Thermostat connections are as follows:

THERMOSTAT CONNECTIONS KEY		
LETTER	COLOR	DESCRIPTION
C	BROWN	Transformer 24VAC Common
R	RED	Transformer 24VAC Hot
G	GREEN	Evaporator Blower
Y1	BLUE	Compressor call
W2	WHITE	First Stage Heating

Table 6 - Thermostat Connections Key

THERMOSTAT INSTALLATION

The Thermostat should be located on an interior wall in a larger room, away from supply duct draft. Position the thermostat back plate against the wall so that it appears level and so the thermostat wires protrude through the middle of the back plate mounting holes and drill holes with a 3/16 in. bit. Install supplied anchors and secure plate to the wall. Thermostat wire must be 18 AWC wire.

CONTROLS

ECO SERIES CONTROL MODULE

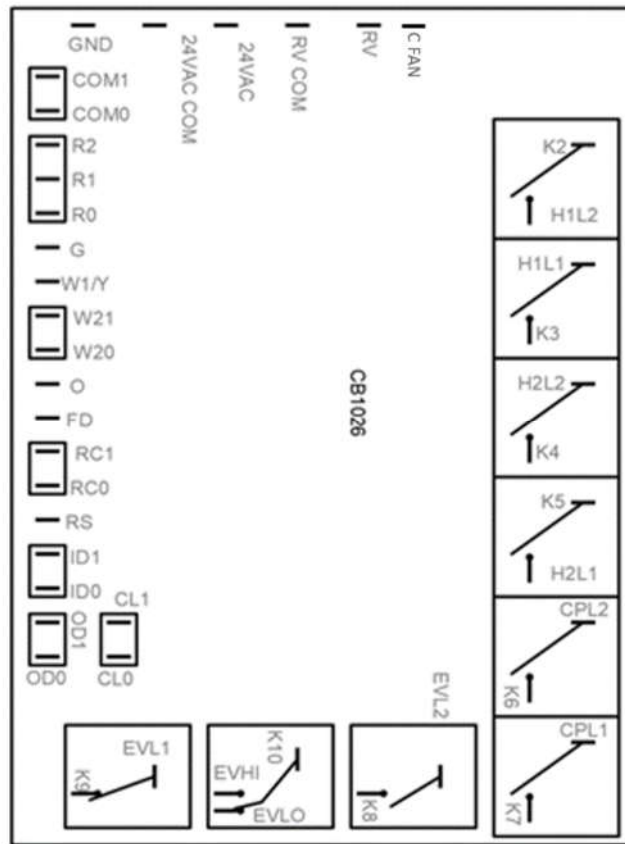

Figure 12 - ECO Series Control Module

POWER-UP

When power is first applied to the control, all timers are reset. The control will execute a random start delay before allowing normal operation of outputs, and a compressor anti short cycle delay (6 minute) before allowing the compressor output to be energized. While the control is operating, all of the inputs are continuously monitored for a change in the desired operating status.

RANDOM START DELAY

There will be a control random start delay which will vary from 10 to 60 seconds, which will be executed before energizing outputs when the control is powered up. All control outputs remain off during the random start delay.

ANTI-SHORT CYCLE DELAY

After the compressor output has been energized the control will execute a 6-minute anti short cycle delay from the time the compressor is de-energized, before allowing the compressor output to be energized again. A 6-minute anti short cycle delay will be present at control power up, before allowing the compressor output to be energized.

POWER INTERRUPTIONS

If the power to the control is interrupted for less than 100 milliseconds, the control shall resume operation at the same point in the timing cycle if the compressor output is not energized. Relays may temporarily drop out during the power interruption. Power interruptions greater than 100 milliseconds are to reset the control as a power- sequence. If the power to the control is interrupted for more than 40 milliseconds with the compressor output energized, the compressor output will be de-energized, and the control will execute a short cycle delay before allowing the compressor to operate.

CONTROLS (continued)

COOLING OPERATION

STEADY STATE COOLING

When the “W1/Y” input is present, and the compressor is not being held off by the anti-short cycle timer, the control will operate in steady state cooling. In steady state cooling, the compressor and condenser fan are energized. After a 7 second delay the high-speed evaporator fan is energized. If the W2 input is applied to the control, the first stage auxiliary heat output will be energized immediately and the second stage auxiliary heat output will be energized after 15 seconds. The compressor and condenser outputs will be shut off and the evaporator fan will switch to low speed. When the “W2” input is removed, both auxiliary outputs will be turned off immediately, and the control will return to steady state cooling mode, assuming the “W1/Y” input is still present. When the “W1/Y” input is removed, the compressor and condenser fan will be turned off immediately. The high-speed evaporator fan will be turned off following a 45 second blower off delay.

LOW AMBIENT SHUTDOWN

When the control is operating in steady state cooling, and the “INDOOR” input is applied (temperature 30°F [-1] and below), the control will immediately de-energize the compressor and condenser fan. The high-speed evaporator will be turned off following a 45 second blower off delay. The compressor will go into an anti-short cycle delay for 6 minutes.

LOW AMBIENT COOLING LOCKOUT

When the control is operating in steady state cooling and the “COOLING LOCKOUT” input is applied (Outside Temperature of 40°F [4.4°C] or less) the control will continue to operate for 10 minutes. After 10 minutes, if the “COOLING LOCKOUT” is still active the cooling operation will be locked out for 30 minutes and run high speed evaporator during the lockout. After 30 minutes the control will be returned to normal operation.

AUXILIARY HEATING OPERATION

THERMOSTAT CALL FOR AUXILIARY HEAT

If the “W2” thermostat input is present without a “W1/Y” input, the control will operate in the auxiliary heat mode. The low-speed evaporator fan and the first stage auxiliary heat outputs will be energized immediately when the “W2” input is received. After a 15 second staging delay, the second stage auxiliary heat

output will be energized. When the “W2” input is removed, all of the outputs will be turned off immediately.

If the “W2” thermostat input is present with a “W1/Y” input, the control will switch the system to auxiliary heat mode and will de-energize the compressor and condenser fan immediately.

LOW ROOM AMBIENT AUXILIARY HEAT

If the “RS” low room temperature input becomes active (switch closes), the control will operate in the auxiliary heat mode, regardless of any other control inputs. The low-speed evaporator fan and the first stage auxiliary heat outputs will be energized immediately when the “RS” input is received. After a 15 second staging delay, the second stage auxiliary heat output will be energized. When the “RS” input is removed, all of the outputs will be turned off immediately.

FRONT DESK SHUTDOWN OPERATION

If the front desk shutdown input “FD” is removed (switch opens), operation based upon the “W1/Y”, “W2” and “G” thermostat input will be prohibited. Auxiliary heat operation based upon the low room ambient temperature input “RS” is the only heating or cooling operation that will be allowed. When the “FD” input is re-applied (switch closes), the control will return to normal operation based upon the thermostat inputs.

THERMOSTAT INPUT OPERATION (W1/Y, W2)

If both “W1/Y” and “W2” thermostat inputs are active, the control will lock out or interrupt the operation of the compressor.

FIELD SPEEDUP MODE

The field speedup mode is entered by applying R (24VAC) to W1/Y (active) and closing the cooling lockout sensor switch (24VAC applied to the terminal). The field speedup mode is automatically canceled after 5 minutes. While in the field speedup mode, control timings will be reduced as follows:

Random Start Delay	0 Seconds
Short Cycle Delay	5 seconds
Cooling Blower off Delay	0 Seconds
Auxiliary Heat Staging Delay	1 Second

BLOWER DATA

ECE BLOWER DATA

ECE BLOWER DATA												
MODEL	Motor Tap	Motor Speed	IWC STATIC PRESSURE									
			0.10		0.20		0.30		0.40		0.50	
			SCFM	W	SCFM	W	SCFM	W	SCFM	W	SCFM	W
ECE09203	1	T1 ^H	308	45	290	47	272	48	254	48	235	47
	2	T2 ^C	352	58	334	60	316	60	298	60	279	60
	3	T3	453	95	435	97	417	98	399	98	380	98
ECE12203	1	T1 ^H	317	51	300	49	281	49	263	49	244	48
	2	T2 ^C	453	100	436	99	417	99	398	98	380	97
	3	T3	510	128	493	127	474	127	456	126	437	125
ECE12205	1	T1 ^H	441	95	424	94	405	94	386	93	368	92
	2	T2 ^C	453	100	436	99	417	99	398	98	380	97
	3	T3	510	128	493	127	474	127	456	126	437	125
ECE182203	1	T1 ^H	392	47	366	47	343	47	311	43	267	35
	2	T2 ^C	723	155	696	155	673	155	641	151	598	143
	3	T3	820	206	793	206	770	206	738	202	695	194
ECE182205	1	T1 ^H	502	66	476	65	452	66	420	62	377	54
	2	T2 ^C	723	155	696	155	673	155	641	151	598	143
	3	T3	820	206	793	206	770	206	738	202	695	194
ECE182207	1	T1 ^H	683	135	656	135	633	136	601	132	558	123
	2	T2 ^C	723	155	696	155	673	155	641	151	598	143
	3	T3	820	206	793	206	770	206	738	202	695	194
ECE182210	1	T1 ^H	820	206	793	206	770	206	738	202	695	194
	2	T2 ^C	723	155	696	155	673	155	641	151	598	143
	3	T3	820	206	793	206	770	206	738	202	695	194
ECE24205	1	T1 ^H	511	67	481	67	450	66	417	63	378	59
	2	T2 ^C	788	167	758	167	727	166	694	163	656	159
	3	T3	883	222	853	222	822	220	789	218	751	213
ECE24207	1	T1 ^H	694	125	663	125	632	124	599	121	561	117
	2	T2 ^C	788	167	758	167	727	166	694	163	656	159
	3	T3	883	222	853	222	822	220	789	218	751	213
ECE24210	1	T1 ^H	829	188	799	189	768	187	735	185	696	180
	2	T2 ^C	788	167	758	167	727	166	694	163	656	159
	3	T3	883	222	853	222	822	220	789	218	751	213
ECE30205	1	T1 ^H	546	84	516	78	481	70	442	62	400	52
	2	T2 ^C	894	233	864	226	830	218	790	210	748	200
	3	T3	983	297	953	290	918	282	879	274	837	264
ECE30207	1	T1 ^H	699	128	669	122	635	114	595	105	553	95
	2	T2 ^C	894	233	864	226	830	218	790	210	748	200
	3	T3	983	297	953	290	918	282	879	274	837	264
ECE30210	1	T1 ^H	832	194	802	188	767	180	728	171	686	161
	2	T2 ^C	894	233	864	226	830	218	790	210	748	200
	3	T3	983	297	953	290	918	282	879	274	837	264

Table 7 - ECE BLOWER DATA

^C Factory Default Cooling Airflow

^H Factory Default Electric Heat and Hot Water Airflow

T1 is reserved for Fan Only Operation (All models)

Blower performance data based on a dry coil at 70°F DB EAT with a standard 1" clean air filter

Do not run the unit at higher than .5 IWC

For information on how to change the blower speed, review the unit wiring diagram

WIRING DIAGRAMS

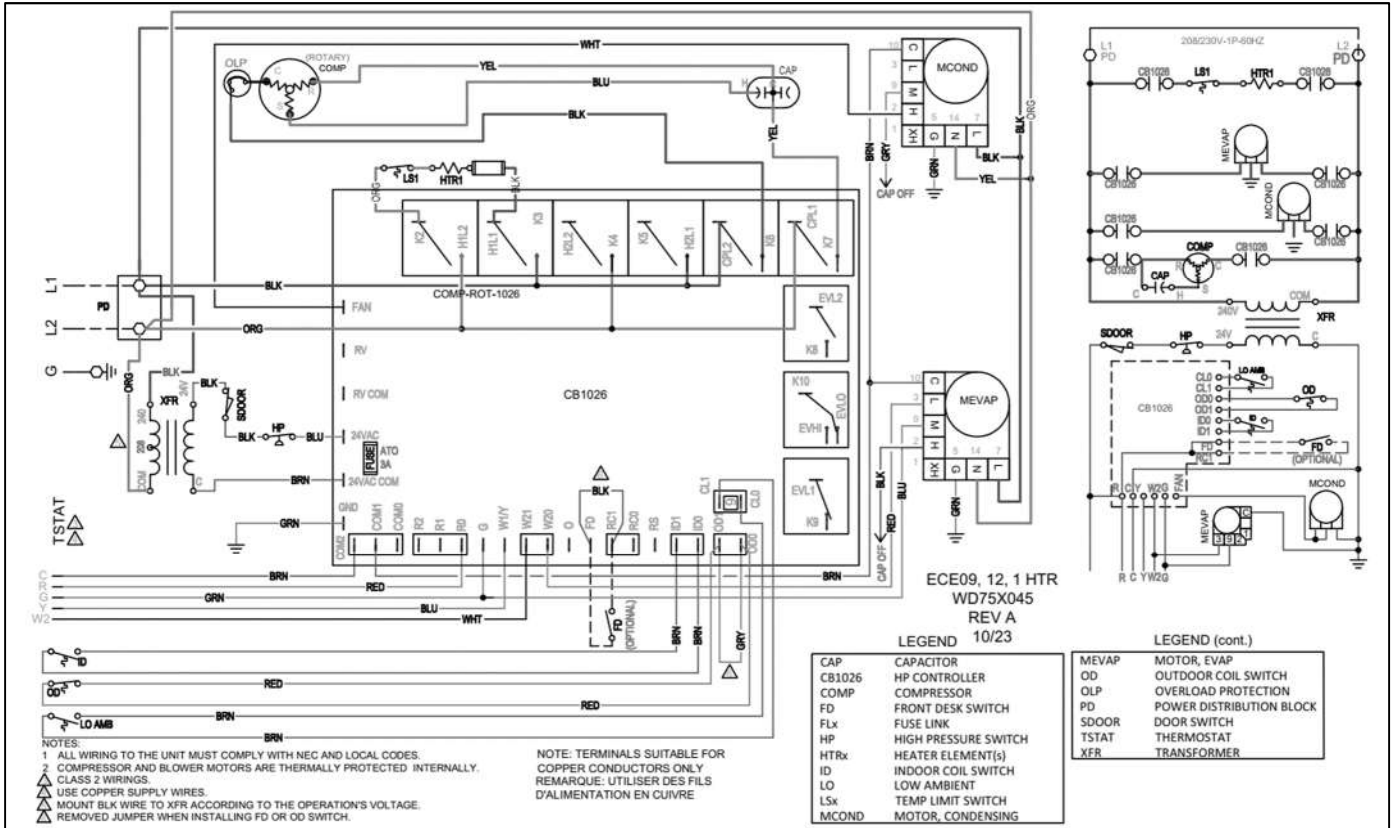

Figure 13 - ECE09-012, 1HTR, 1PS Wiring Diagram

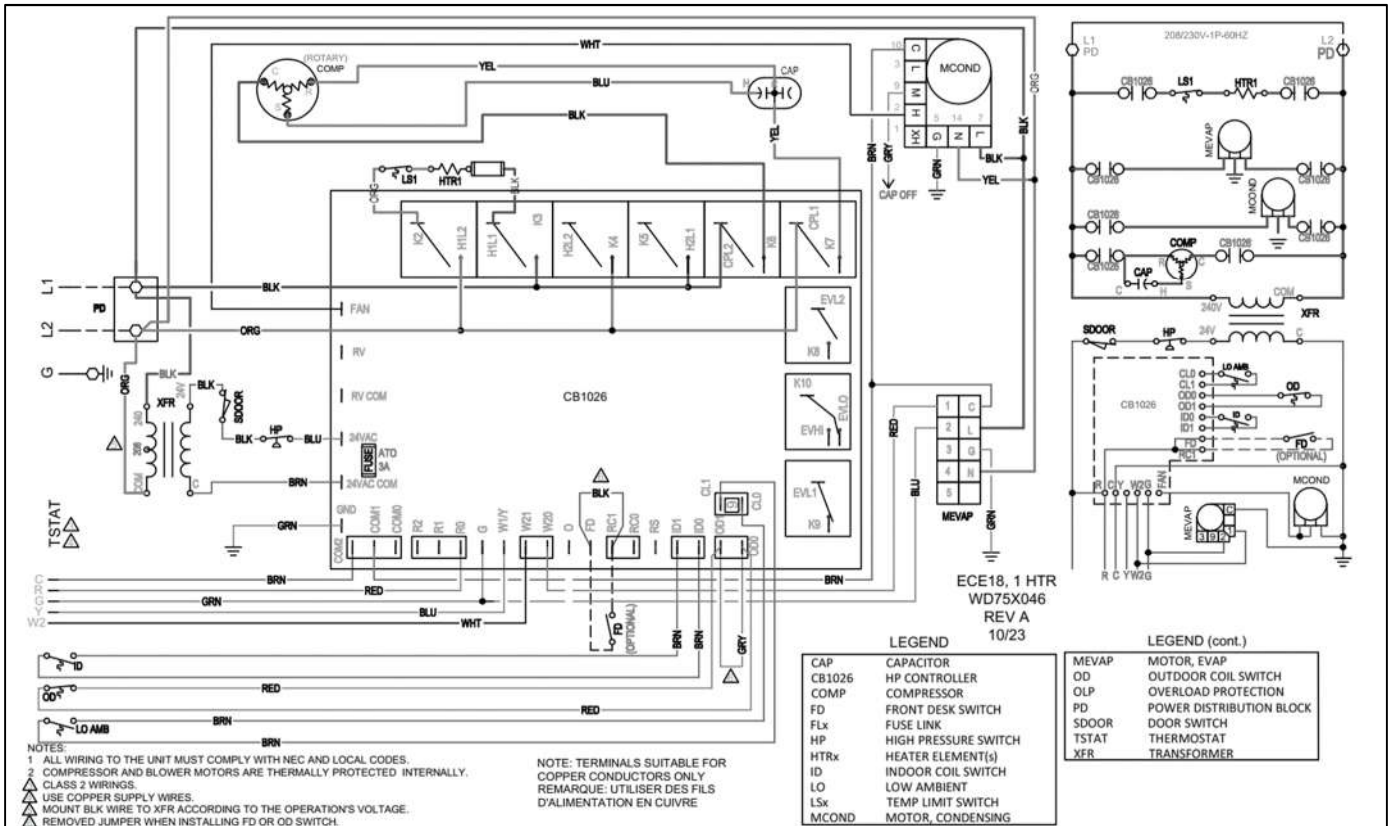

Figure 14 - ECE18, 1HTR, 1PS Wiring Diagram

Wiring Diagrams

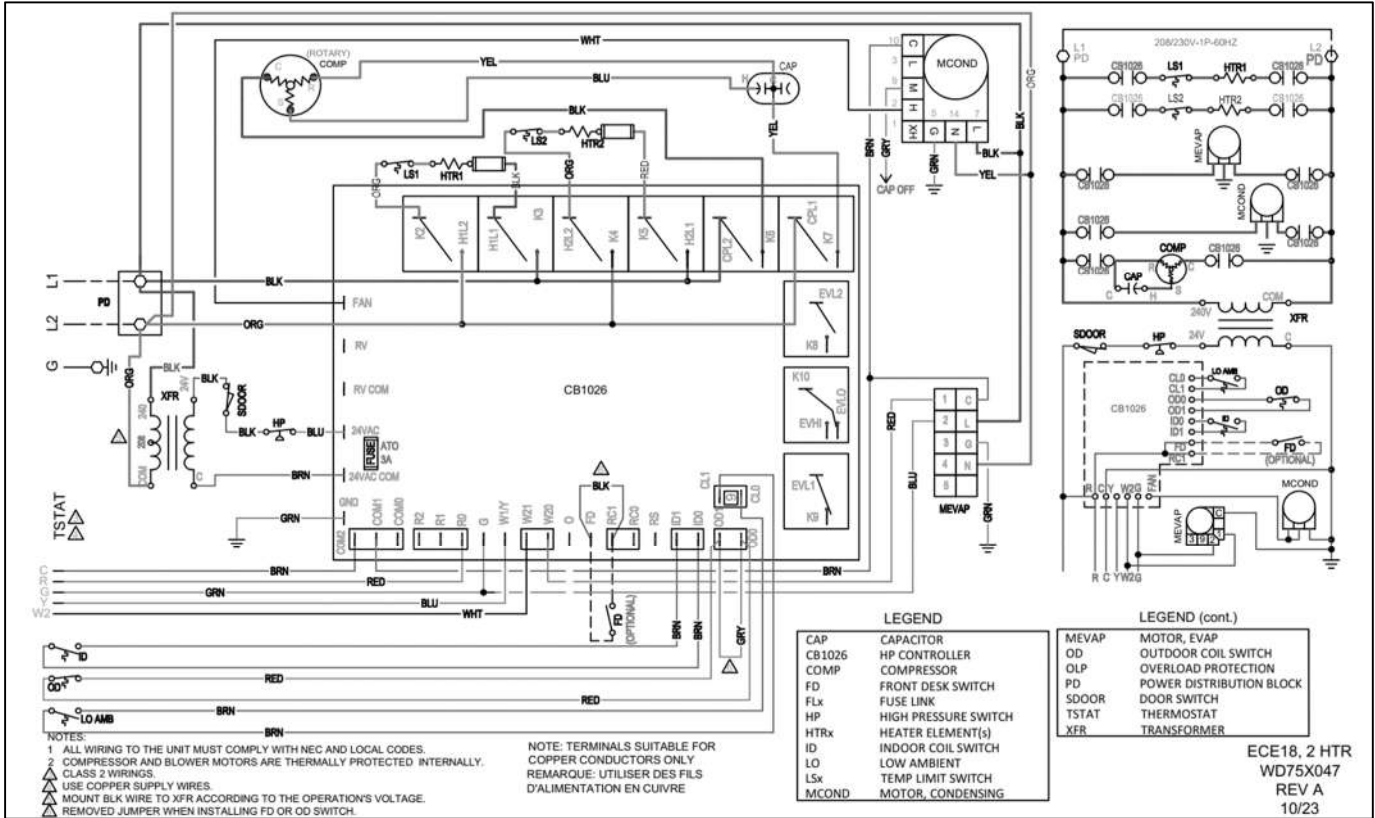

Figure 15 - ECE18, 2HTR, 1PS Wiring Diagram

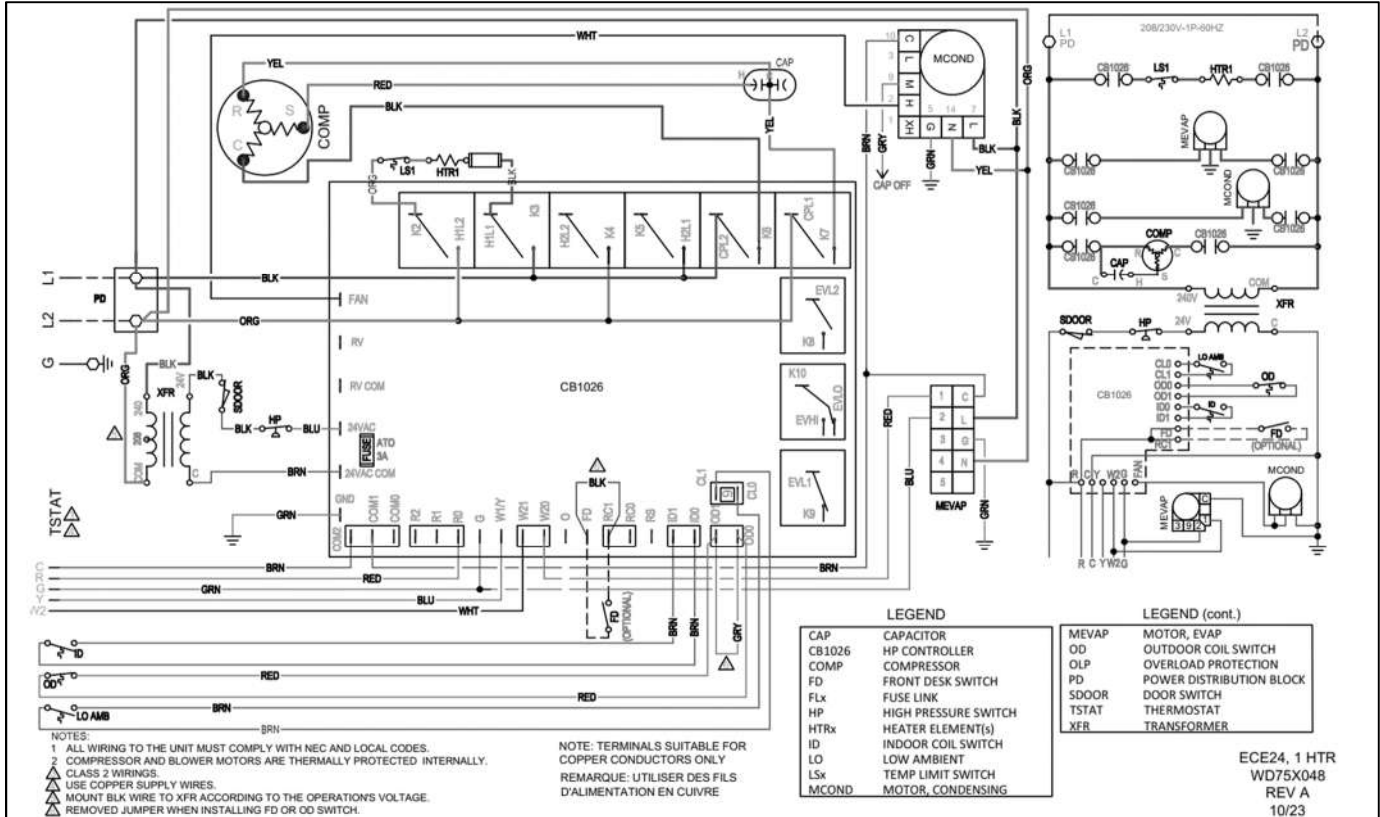

Figure 16 - ECE24, 1HTR, 1PS Wiring Diagram

Wiring Diagrams

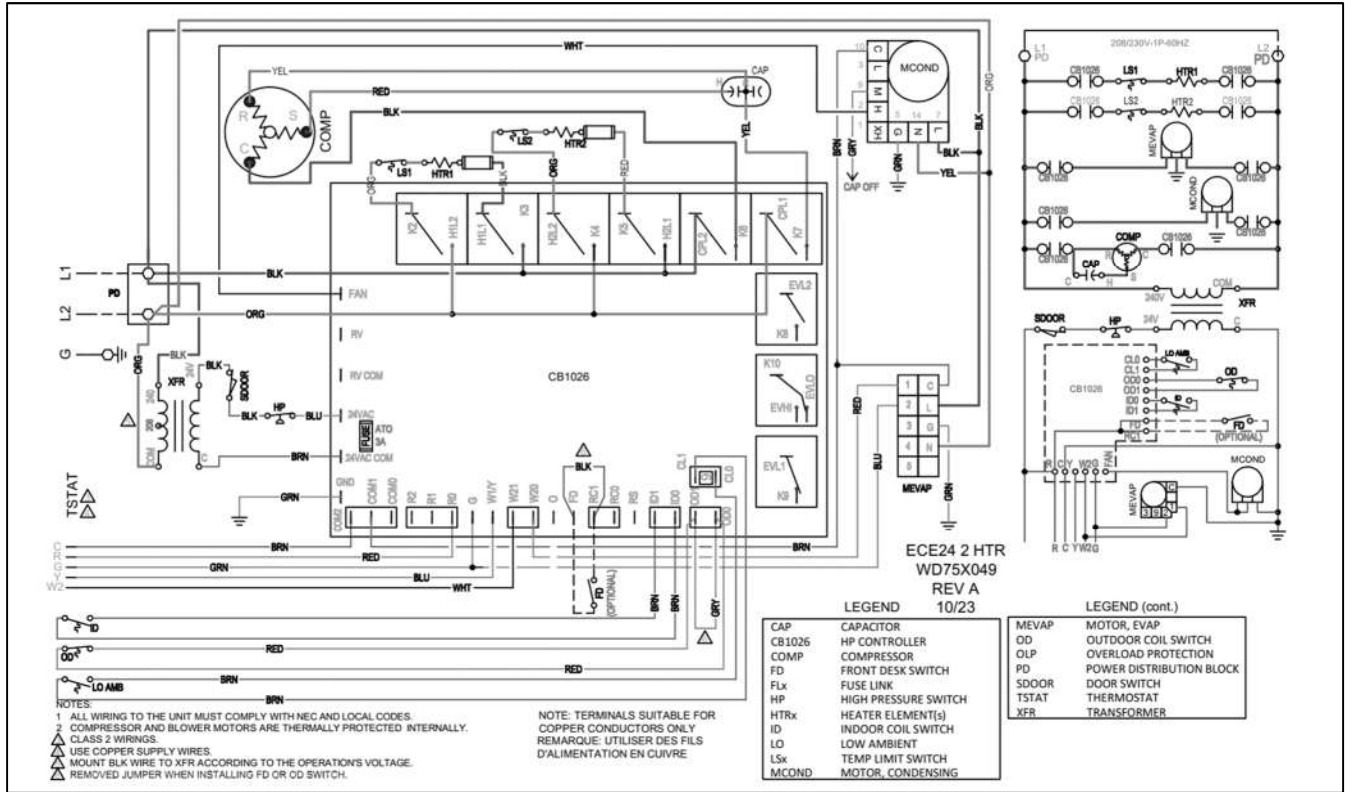

Figure 17 - ECE24, 2HTR, 1PS Wiring Diagram

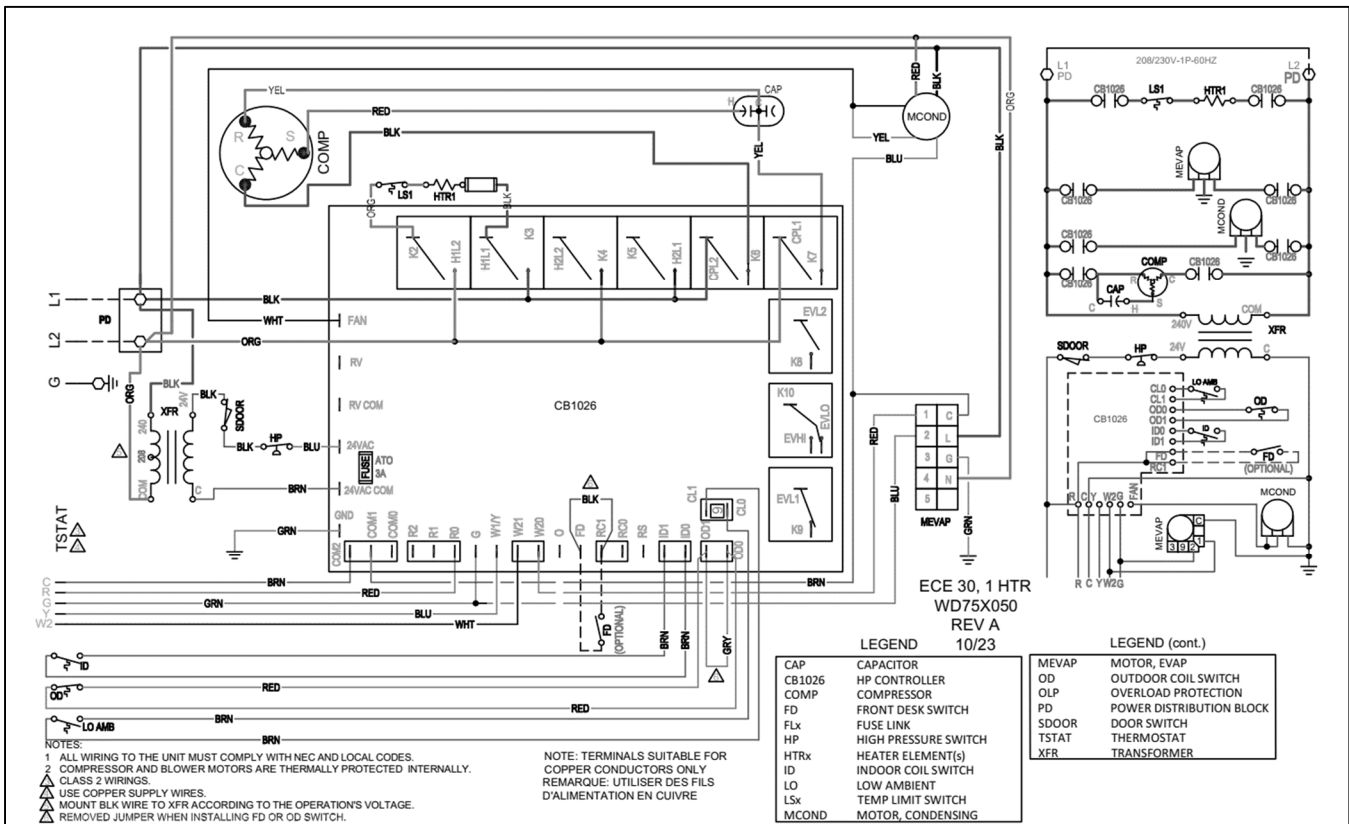

Figure 18 – ECE30, 1HTR, 1PS Wiring Diagram

Wiring Diagrams

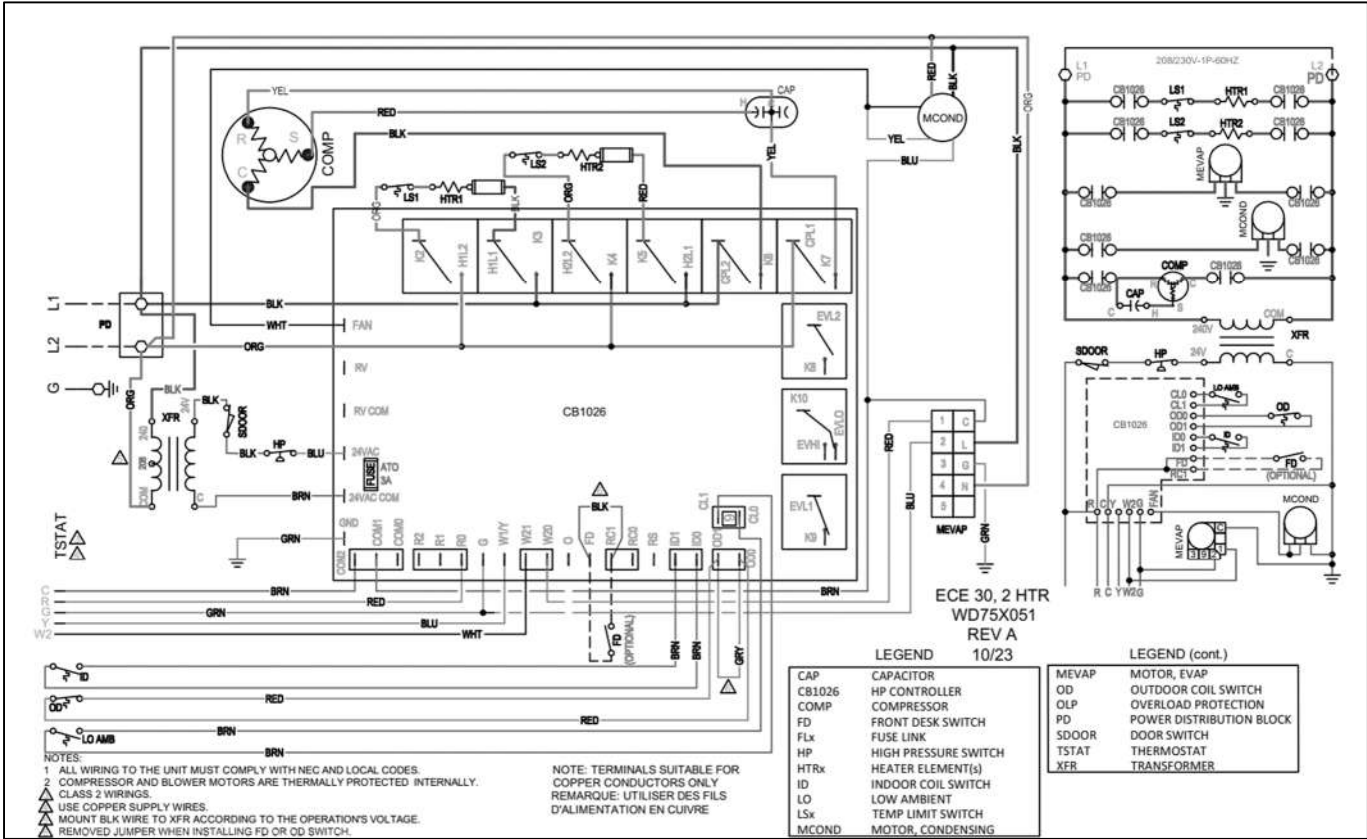





Figure 19 - ECE30, 2HTR, 1PS Wiring Diagram

STARTUP INSTRUCTIONS

PRE-STARTUP CHECKS

Before start-up, thoroughly check all the components. Optimal operation of equipment requires cleanliness. Often after installation of the equipment, additional construction activities occur. Protect the equipment from debris during these construction phases.

	WARNING	
Electrically ground the unit by connecting ground wire to ground lug. Failure to properly ground the unit may result in personal injury or death.		

	CAUTION	
Wire any field installed device such as a fan switch or thermostat furnished by the factory in strict accordance with the wiring diagram supplied with the unit. Failure to properly wire the unit could result in damage to components and will void all warranties.		



PRIOR TO THE STARTUP OF THE UNIT

1. Ensure supply voltage matches nameplate data.
2. Ensure the unit is properly grounded
3. With the power off, check blower wheel set screws for proper tightness and that the blower wheel rotates freely.
4. Ensure unit will be accessible for servicing.
5. Ensure condensate line is properly sized, run, trapped, pitched and tested.
6. Ensure all cabinet openings and wiring connections have been sealed.
7. Ensure clean filters are in place.
8. Ensure all access panels are in place and secured.
9. Ensure that all air has been vented from the water coil.
10. Verify that all electrical connections are tight and secure.
11. Check the electrical overcurrent protection and wiring for the correct size.
12. Verify that the low voltage wiring between the thermostat and the unit matches the wiring diagram.

COOL- PAK AC UNITS

1. Set thermostat system switch to “OFF” position and fan switch to “Auto” position. Apply power to the COOL-PAK Unit.
2. Set fan switch to “On”, indoor blower should operate.
3. Return fan switch to “Auto”, indoor blower should de-energize.

4. Set system switch to “Cool” and lower the thermostat set point to coldest setting. The compressor should energize as well as the outdoor fan and indoor blower.
5. Return thermostat set-point to a temperature warmer than room temperature and the compressor, indoor and outdoor fan should de-energize.

	NOTE	
The COOL-PAK employs a compressor short cycle delay (approx. 3 minutes) which will not allow the compressor to immediately restart following shut down. Additional delays may be experienced if using an electronic digital thermostat.		

6. Move system switch to “Heat: and raise thermostat to a set point slightly higher than room temperature (less than 2 degrees). The indoor fan and electric heat should energize.

STARTUP & PERFORMANCE CHECKLIST INSTRUCTIONS:

The warranty may be void unless the **FIGURE 20 – Startup & Performance Checklist** is completed and returned to the warrantor. If the unit is not installed properly, the warranty will be void, as the manufacturer will not be held accountable for problems that stem from improper installation.

TROUBLESHOOTING

PROBLEM	POSSIBLE CAUSE	CHECKS & CORRECTIONS
ENTIRE UNIT DOES NOT RUN	Power supply off	Apply power; close disconnect.
	Blown Fuse	Replace fuse or reset circuit breaker. Check for correct fuses.
	Voltage supply low	If voltage is below minimum voltage specified on unit data plate, contact lower power company.
	Thermostat	Set the fan to "ON", the fan should run. Set thermostat to "COOL" and lowest temperature setting, the unit should run in the cooling mode. Set unit to "HEAT" and the highest temperature setting, the unit should run in the heating mode. If neither the blower nor compressor run in all three cases, the thermostat could be mis-wired or faulty. To ensure mis-wired or faulty thermostat verify 24 volts is available on the condenser section low voltage terminal strip between "R" and "C", "Y" and "C", and "B" and "C". If blower does not operate, verify 24 volts between terminals "G" and "C" in the air handler. Replace the thermostat if defective.
BLOWER OPERATES BUT COMPRESSOR DOES NOT RUN	Thermostat	Check setting, calibration and wiring.
	Wiring	Check for loose or broken wires at compressor, capacitor or contractor.
	Compressor overload open	If the compressor is cool and the overload will not reset, replace the compressor.
	Compressor motor grounded	Internal wiring grounded to the compressor shell. Replace compressor. If compressor burnout, install new filter dryer.
UNIT OFF ON HIGH PRESSURE CONTROL	Compressor windings open	After compressor has cooled, check continually of compressor windings. If the windings are open, replace the compressor.
	Discharge pressure too high	In "COOLING" mode: Lack of or inadequate air flow. Entering air temperature too warm. Blower inoperative, clogged filter or restriction in ductwork. In "HEATING" mode: Lack of or inadequate airflow. Entering air temperature too cold. Blower inoperative, clogged filter or restriction in ductwork.
	Refrigerant charge	The unit is overcharged with refrigerant. Reclaim refrigerant, evacuate and recharge with factory recommended charge.
UNIT OFF ON LOW PRESSURE CONTROL	High pressure switch	Check for defective or improperly calibrated high-pressure switch.
	Suction Pressure too low	In "COOLING" mode: Lack of or inadequate air flow. Entering air temperature too cold. Blower inoperative, clogged filter or restriction in ductwork. In "HEATING" mode: Lack of or inadequate airflow. Entering air temperature too warm. Blower inoperative, clogged filter or restriction in ductwork.
	Refrigerant charge	The unit is low on refrigerant. Check for refrigerant leak, repair, evacuate and recharge with factor recommended charge.
UNIT SHORT CYCLES	Low pressure switch	Check for defective or improperly calibrated low-pressure switch.
	Unit oversized	Recalculate heating and cooling loads.
	Thermostat	Thermostat installed near a supply air register, relocate thermostat. Check heat anticipator.
	Wiring and controls	Loose connections in the wiring or a defective compressor contactor.

Table 8 - Troubleshooting Table (1 of 2)

TROUBLESHOOTING (continued)

PROBLEM	POSSIBLE CAUSE	CHECKS & CORRECTIONS
INSUFFICIENT COOLING OR HEATING	Unit undersized	Recalculate heating and cooling loads. If not excessive, possibly adding insulation will rectify the situation.
	Loss of conditioned air by leaks	Check for leaks in ductwork or introduction of ambient air through doors or windows.
	Airflow	Lack of adequate airflow or improper distribution of air. Replace dirty air filter.
	Refrigerant charge	Low on refrigerant charge causing inefficient operation.
	Compressor	Check for defective compressor. If discharge is too low and suction pressure is too high, compressor is not pumping properly. Replace compressor.
	Operating pressures	Compare unit operating pressures to the pressure / temperature chart for the unit.
	Refrigerant metering device	Check for possible restriction or defect. Replace if necessary.
Moisture, non-condensable	The refrigerant system may be contaminated with moisture or non-condensable. Reclaim refrigerant, evacuate and recharge with factory recommended charge.	

Table 9 - Troubleshooting Table (2 of 2)

MAINTENANCE & SERVICE

PREVENTIVE MAINTENANCE

To ensure maximum performance and service life of equipment, a formal schedule of regular preventative maintenance must be established and adhered to.

Failure to do establish and perform preventative maintenance program can void the manufactures warranty.

If servicing or major repairs are required, the complete unit can be removed as follows:

1. Disconnect the electrical power circuit supplying the unit.
2. Remove line and low voltage wiring from unit,
3. Remove rear access panel.
4. Remove supply duct from top of unit.
5. Slide unit back out of sleeve.
6. Unit may be removed from closet.

To reinstall unit, use the installation procedure outlined above.

WARNING

It is a violation of federal law to discharge refrigerant into the atmosphere. Use proper reclaiming methods and equipment when installing or servicing this unit. Service should be performed by a **QUALIFIED** service agency.

The refrigerant system contained in the unit normally requires no maintenance since it is a closed, self-contained system.

CAUTION

All appropriate personal protection equipment should be worn when servicing or maintaining this unit.

Personal injury can result from contact with sharp metal edges, moving parts, and hot or cold surfaces.

FAN

The fan should be inspected and cleaned annually in conjunction with maintenance of the motor and bearings. It is important to keep the fan section and motor clean and free from obstruction to prevent imbalance, vibration, and improper operation.

WARNING

ELECTRIC SHOCK HAZARD

Check motor connections to ensure they are secure and in accordance with the unit wiring diagram.

ECM motors have line voltage power applied at all times.
VERIFY THAT POWER IS DISCONNECTED BEFORE SERVICING.

The air filter should be cleaned or replaced every 30 days or more frequently if severe operating conditions exist. Always replace the filter with the same type and size as originally furnished.

COIL

Clean all heat transfer surfaces and remove all dirt, dust, and contaminants that potentially impairs air flow using industry accepted practices. Care should be taken not to bend coil fin material.

CONDENSATE DRAIN PAN AND PIPE

Check and clean all dirt and debris from pan. Ensure drain line is free flowing and unobstructed.

MAINTENANCE UPDATES

Check regularly for a current copy of the maintenance program log which can be found at under “product information”.

UNIT PERFORMANCE

Record performance measurements of volts, amps and air temperature differences (both heating and cooling). A comparison of logged data with start-up and other annual data is useful as an indicator of general equipment condition.

UNIT LOCKOUT

Air flow problems could cause periodic lockouts. The lockout (shutdown) of the units is a normal protective result. Check for airflow rates (may be caused by dirty filter) and air temperatures.

LABORATORY TESTING

When the unit has less than 100 operational hours and the coils have not had sufficient time to be “seasoned”, it is necessary to clean the coils with mild surfactant such as calgon to remove the oils left by manufacturing processes.

STARTUP & PERFORMANCE CHECKLIST



CUSTOMER _____ STARTUP DATE _____ JOB # _____
 ADDRESS _____ SERVICING COMPANY _____
 _____ TECHNICIAN _____
 MODEL # _____ SERIAL # _____ PHONE # _____

INSTALLATION CHECK LIST

- Inspect the unit for transit damage and report any damage on the carrier's freight bill.
- Check model number to insure it matches the job requirements.
- Install field accessories and unit adapter panels as required. Follow accessory and installation manuals.
- Verify field wiring, including the wiring to any accessories.
- Check all multi-tap transformers, to ensure they are set to the proper incoming voltage.
- Power the unit. Bump the motor contractor to check rotation. Three phase motors are synchronized at the factory. If the blower fans are running backwards, de-energize power to the unit, then swap two of the three incoming electrical lines to obtain proper phasing. Re-check.
- Perform all start up procedures outline in the installation manual shipped with the unit.
- Fill in the Start Up information as outlined below and on the following page.
- Provide owner with information packet. Explain the thermostat and unit operation.

START UP INFORMATION SHEET

ELECTRICAL

Supply Voltage L1-L2 _____	Compressor Amps _____
Running Voltage L1-L2 _____	Blower Amps _____
Secondary Voltage _____	Condenser Fan Amps _____
C (black) to G (green) Volts* _____	
C (black) t W (white) Volts* _____	

AIRFLOW

Intake Design CFM	Exhaust Design CFM
Pressure Drop _____	Pressure Drop _____
Calculated CFM _____	Calculated CFM _____
Amb db Temp _____	Amb db Temp _____
Return Air db Temp* _____	Return Air db Temp* _____
Tempered Air db Temp* _____	Tempered Air db Temp* _____

TEMPERATURES

Outdoor Air Temperature _____ DB _____ WB	Cooling Supply Air Temperature _____ DB _____ WB
Return Air Temperature _____ DB _____ WB	Heating Supply Air Temperature _____ DB _____ WB

Figure 20 – Startup & Performance Checklist

NOTES



P.O. Box 270969 Dallas, TX 75227
www.firstco.com or www.ae-air.com

The manufacturer works to continually improve its products. It reserves the right to change design and specifications without notice.

©2023 First Co., Applied Environmental Air