

OPERATION, MAINTENANCE
& INSTALLATION MANUAL
For
"ELXC" AND "ELXC-UVi" SERIES
VENTILATORS

GAYLORD INDUSTRIES

10900 S.W. AVERY STREET - TUALATIN, OREGON 97062 U.S.A.
email: info@gaylordventilation.com - 800-547-9696 - FAX: 503-692-6048
www.gaylordventilation.com

ALL RIGHTS RESERVED. NO PART OF THIS BOOK MAY BE REPRODUCED, STORED IN A RETRIEVAL SYSTEM, OR TRANSMITTED IN ANY FORM BY AN ELECTRIC, MECHANICAL, PHOTOCOPYING, RECORDING MEANS OR OTHERWISE WITHOUT PRIOR WRITTEN PERMISSION OF GAYLORD INDUSTRIES. COPYRIGHT 2011.

© Copyright 2015, Gaylord Industries

The manufacturer reserves the right to modify the materials and specifications resulting from a continuing program of product improvement or the availability of new materials.

ADDITIONAL COPIES \$25.00



Breathe easy.

To Our Customers:

Congratulations on your recent purchase of an ELXC or ELXC-UVi Series Ventilator. We are proud to be able to provide you with a quality product that exemplifies our long standing dedication to quality engineering and manufacturing.

Your ELXC or ELXC-UVi Series Ventilator is assembled from some to the very finest components available and is designed for years of efficient, effective, and trouble-free operation. In addition, the product has undergone rigorous quality control inspections and testing prior to shipment.

If you have any questions, please contact us at info@gaylordventilation.com or by calling us toll free 800-547-9696. We are more than happy to help.

Sincerely,
Gaylord Industries

Gaylord Industries
10900 SW Avery St.
Tualatin, OR 97062
Office: 503.691.2010
Toll Free: 800.547.9696
www.gaylordventilation.com

Table of Contents

Chapter 1 – Introduction	Page
Introduction	1-1
Model Description	1-2
Model Number Sequence	1-3
Chapter 2 – Principles of Operation	
ELXC Series - Turning on the Exhaust Fan	2-1
ELXC Series - Turning off the Exhaust Fan	2-3
ELXC Series - Wash Cycle	2-3
ELXC Series - Fire Protection	2-5
ELXC-UVi Series - Turning On the Exhaust Fan and UV System	2-7
ELXC-UVi Series - Turning Off the Exhaust Fan and UV System	2-10
ELXC-UVi Series - Wash Cycle	2-11
ELXC-UVi Series - Fire Protection	2-13
Wash System Overview	2-15
Wash System - Frequency and Length of Wash	2-15
Wash System - Recommended Detergent	2-17
Balancer Dampers	2-19
Chapter 3 - Maintenance	
Operator Preventative Maintenance	3-1
UV System - Scheduled Preventive Maintenance	3-3
Chapter 4 - Troubleshooting	
Trouble Shooting	4-1
Ventilator Control Matrix	4-5
Chapter 5 – Testing and Repair	
Measuring Airflow	5-1
Makeup Air Guidelines	5-6
Replacing UV Lamps	5-7
Replacing UV Lamp Sockets	5-10
UV Ballast Box – Overview	5-14
UV Ballast Box – Replacing Parts	5-15
UV Ballast Box – Setting Pressure Switches	5-16
Ventilator Water Solenoid Valves	5-23
Ventilator Spray Nozzles	5-25
Chapter 6 - Parts	
Parts - Ventilator	6-1
Parts – UV Ventilator	6-4
Parts – UV Lamp Module	6-5
Parts – UV Ballast Box	6-7
Chapter 7 – Wiring Diagrams	
Wiring Diagrams	7-1
Appendices	
Installation Requirements	A-1
Typical Installation Illustration	A-5
Ventilator Start-Up Inspection and Tests - Overview.....	B-1
Pre-Start-Up Checklist	B-1
Start-Up Inspection and Test Report Forms	B-3
Limited Warranty	Inside Back Cover

Introduction

About this Technical Manual

The purpose of this manual is to provide the Operator, Maintenance and Service personnel instructions for operating, maintaining and troubleshooting the Gaylord Ventilator. Ventilators incorporating UV Systems, most maintenance and all repairs must be performed by a trained and certified service company. This manual also includes information and guidance to contractors for initial installation of the Ventilator.

The manual is divided into chapters for easy reference to a particular subject. The pages in the chapters are numbered with the chapter number, then a dash, and then the page number. So for example pages in Chapter 2 are numbered 2-1, 2-2, 2-3 etc. Figures and Tables are numbered in a similar manor. For example Figure 5-3-2 is on page 5-3 and is the second figure. Please keep your manual in a convenient location so it can be accessed easily.

If you have any questions or concerns with the installation, operation, maintenance or service of your Gaylord Ventilator, please contact Gaylord Industries;

Web: www.gaylordventilation.com

E-Mail: info@gaylordventilation.com

Main Phone: 503-691-2010 Toll Free: 800-547-9696

Safety

It is important that the operator read Chapter 2, Principle of Operation, and Chapter 3, Maintenance, before operating the Ventilator for the first time. Particular attention should be given to all the **Caution** and **Warning** statements.

Related Technical Manuals

1. ELXC and ELXC-UVi Series Ventilators are controlled by a Gaylord Command Center. The specific manual for this control is titled **Operation and Maintenance Manual for the Gaylord Command Center**.
2. ELX and ELX-UVi Ventilators may include a Gaylord "Capture Wall" option. The specific manual for installation of this is titled **Installation Manual – ELX Ventilators with Capture Wall**.

Operation and Maintenance Manuals may be downloaded from the Gaylord website: www.gaylordventilation.com or be obtained by calling Gaylord Industries.

Model Description Overview

The Gaylord Model ELXC Series Ventilator is a high grease extraction efficiency Ventilator that incorporates a hot water Wash Cycle that automatically washes the accumulated grease out of the Ventilator and into the building drain system. The Model ELXC-UVi Series includes the additional feature of an Ultraviolet Light System that dramatically reduces grease accumulation in the exhaust plenum, ductwork and fans.

Both the ELXC and ELXC-UVi Ventilators come in many different models as illustrated below. Your Ventilator may appear slightly different as they may have been custom designed to fit the space and application.

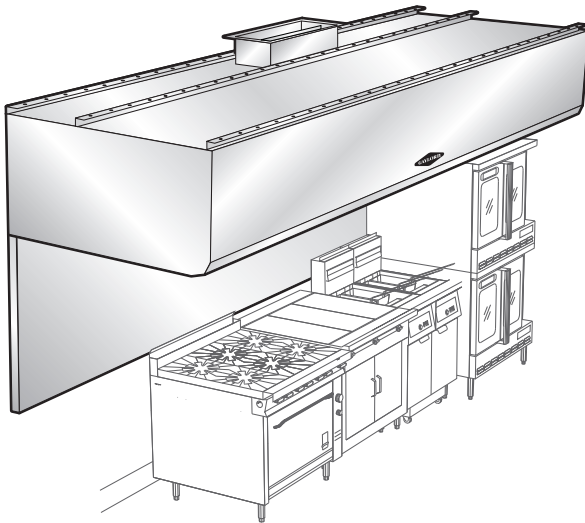

Figure 1-2-1
Model ELXC Series
Wall Mounted Canopy Shown With
Optional Capture Wall

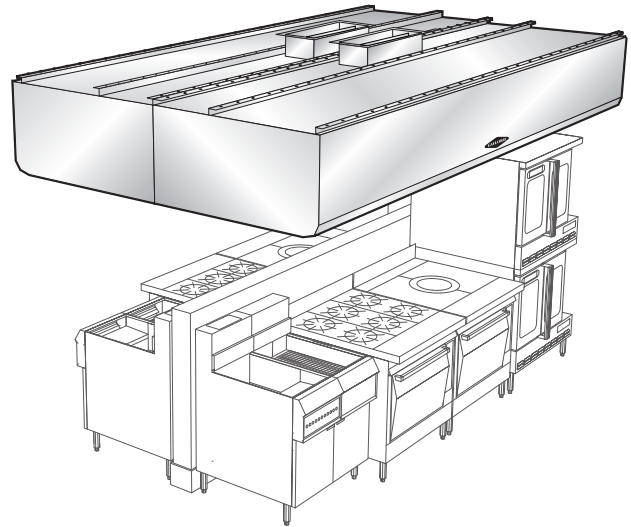

Figure 1-2-2
Model ELXC-BB Series
Island Style for all Double Island Arrangement

Model Number Sequence

Gaylord Ventilator model numbers are made up of an alphabetic prefix followed by a series of alphabetic and/or numeric suffixes to designate the style of ventilator and various options. Sequence of model numbers is as follows.

1. _____	2. _____	3. _____	4. _____	5. _____	6. _____	7. _____	8. _____	9. _____
<i>Series</i>	<i>Damper Type</i>	<i>Style</i>	<i>Front Lip Design (Option)</i>	<i>Apron Design (If Applicable)</i>	<i>Canopy Front Height (Option)</i>	<i>Solid fuel</i>	<i>AutoStart</i>	<i>Hood Depth</i>

Definition of Prefixes and Suffixes

1. Series

- ELXC** High Efficiency Water Wash Ventilator incorporating XGS Extractors.
ELXC-UVi High Efficiency Water Wash Ventilator incorporating XGS Extractors and UV treatment.

2. Damper Type

- GFBD**.....Gaylord Fire Balancing Damper. Has an electric, thermostatically activated Fire/Balancing damper located at the duct collar with back draft feature. *250°F N.C. Thermostat standard.*
GEBD Gaylord Electric Balancing Damper. Has an electric balancing damper located at the duct collar with back draft feature.
GBD Gaylord Balancing Damper. Mechanical balancing damper located at the duct collar with internal set.
GBD-ES Gaylord Balancing Damper. Mechanical balancing damper located at the duct collar with external set.
ND No Damper.

3. Style

- Blank** Wall mounted canopy style.
CL Island style for single line of cooking equipment using one extraction chamber (**Light to Medium Duty only**).
BBC-CL Island style for single line of equipment using one extraction chamber with one common exhaust duct.
BBC Island style for double line of cooking equipment using on one extraction chamber and one common exhaust duct.
BB Island style for double line of equipment using two extraction chambers and two separate exhaust ducts

4. Front Lip Design (Front lower edge of the hood)

- Blank** Facetted front design with 6 inch return flange. (*3 Break or greater at front lip*) (*CL models to have a maximum of 9"*).
S Square front with 6 inch "Super Capture" lip.

Model Number Sequence

5. Apron Design Designation

- Blank* Capture wall to be added below hood. (Note: *Water Wash drain to run out bottom of capture wall. Access to drain connections to go into capture wall.*)
- A**..... Hood to have an apron, which will terminate at the bottom lower edge of the canopy. (*No interconnecting drains*).
- UW**..... Gaylord UDS to be incorporated into capture wall. (Mixed Intertek and UL listing required).

Chapter 1 - Introduction

6. Front Canopy Profile Option

- Blank* 30 inch or greater canopy height.
- MP**..... **Medium Profile** – Any hood with a front height between 24 inches to 30 inches.
- LP** **Low Profile** - 12 inch to 23 inch front height. (Considerations for proper capture and contain need to be considered with this option).

7. Solid Fuel Equipment (*If Applicable – 700°F Applications only*)

- Blank*..... Cooking equipment powered by sources other than the burning of wood.
- SPA**..... Hood use “XGS-SPA” Spark Arrestor Extractors – Intended applications that utilize the burning of wood as a heat source.

8. AutoStart Option

- Blank* Indicates the hood section does not have Autostart system as required by IMC.
- AS** Indicates the hood section has Autostart conforming with the IMC requirement.
- DCV-F** Indicates the hood is equipped with an AutoStart system conforming with the IMC requirement complying with IMC IECC, Calif. Title 24, IGCC, and ASHRAE Std. 90.1 / 189.
- DCV-FH**..... Indicates the hood is equipped with a DCV system for a single fan multi-hood application.

9. Hood Depth (*Outside of Structural wall to front of hood canopy*)

- (##)**..... Value in inches to indicate the hood depth.

ELXC Series

ELXC Series

Turning On the Exhaust Fan

Caution: Always turn on the exhaust fan before turning on the cooking equipment.

Caution: The chemical fire extinguishing system may discharge if the exhaust fan is not on while the cooking equipment is on or still hot.

Caution: Never operate your Ventilator without the XGS Extractors in place or the Extractor Access Doors open (Refer to Figure 2-2-2).

Operation of the exhaust fan is controlled by the Gaylord Command Center, which is mounted in the Wash Control Cabinet (refer to Figure 2-2-1). To start the exhaust fan push “**START FAN**” on the Command Center. The Command Center control may be programmed to automatically start at a specific time. Refer to the Operation and Maintenance Manual for the Gaylord Command Center for complete operating instructions.

Note 1: The ELXC Series Ventilator may be equipped with a Gaylord Electric Balancing Damper, designated “GEBD” in the Ventilator model number, or a Gaylord combination Fire/Balancing Damper, designated “GFBD” in the model number. The Ventilator model number can be found on the Ventilator Nameplate (Refer to page 2-19 for information on Balancing Dampers and page 5-11 for a sample of the Nameplate). If the Ventilator includes one of these dampers, when the fan is started the damper moves from the closed to open position, and it will take approximately 45 seconds for the exhaust to come up to 100%.

Note 2: Typically ELXC Series Ventilators installed in the United States are equipped with a Gaylord Auto-start Controller that automatically turns on the exhaust fan if the temperature at the sensors mounted in the canopy exceeds 90°F. (Refer to Figure 2-2-2). In some instances Ventilators installed outside the United States will include an Autostart Control. Inclusion of an Autostart Control is designated by the suffix “**AS**” or “**DCA**” in the model number. The Ventilator model number can be found on the Ventilator Nameplate (refer page 5-11 for a sample of the Nameplate). Refer to the Operation and Maintenance Manual for the Gaylord Command Center for complete information on the Autostart Control.

Grease Extraction

Grease is extracted by the use of Gaylord Model XGS Extractors located behind the Extractor Access Doors (Refer to Figure 2-2-2). The hot contaminate-laden air rising from the cooking surface enters the inlet slot, turns and is drawn through the Extractors where a high percentage of the grease and other particulate are extracted from the air stream. The extracted liquid grease will drain down the Extractors and into the Grease Canal which then drains into the Grease Gutter. The sticky grease will remain in the Extractor. The Extractors, Grease Canal and Grease Gutter are washed periodically by the automatic Wash Cycle, while the fan is on.

The Gaylord Industries Model XGS Extractor is designed to deliver the absolute optimum in collection efficiency at the lowest possible pressure drop. The Extractors are ETL Recognized as part of the ELXC Ventilator. They are constructed of corrosion resistant stainless steel.

ELXC Series - Cont.



Figure 2-2-1
Wash Control Cabinet

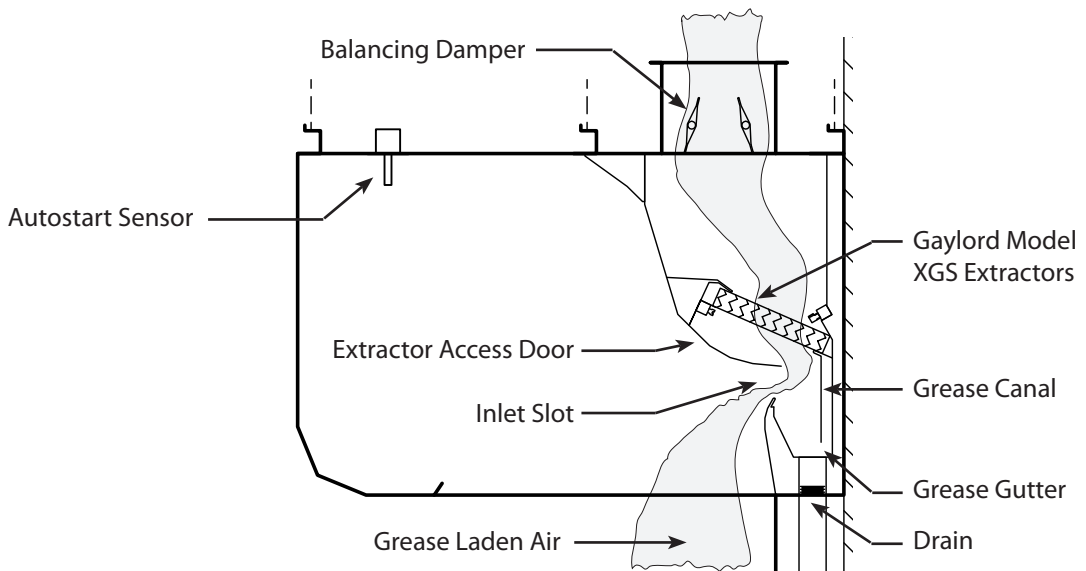

Figure 2-2-2
Grease Extraction

ELXC Series - Cont.

Turning Off the Exhaust Fan

Caution: Always turn off the cooking equipment and allow to cool before turning off the exhaust fan. The chemical fire extinguishing system may discharge if the cooking equipment is on or hot when the exhaust fan is off.

At the end of the cooking day, turn off the cooking equipment and allow to cool before turning off the exhaust fan. To turn off the exhaust fan push **“STOP FAN”** on the Gaylord Command Center (Refer to Figure 2-2-1). The Command Center control may be programmed to automatically turn off the exhaust fan at a specific time. Refer to the Operation and Maintenance Manual for the Gaylord Command Center for complete operating instructions.

Note 1: If the Ventilator is equipped with a Gaylord Autostart Controller, the exhaust fan will stay on if the temperature at the sensor mounted in the canopy exceeds 90°F. (Refer to Figure 2-2-2). Once the temperature drops below 90°F., the fan will continue to run for 15 minutes and then shut off.

Note 2: If the Ventilator is equipped with a Gaylord Electric Balancing Damper, designated “GEBD” or a Gaylord combination Fire/Balancing Damper, designated “GFBD”, when the fan is turned off the damper will move from the open to closed position and remain closed until the exhaust fan is re-started. Closing the damper saves building energy by not allowing conditioned air from drafting up the exhaust duct, or in cold climates prevents cold air from coming down the duct and into the kitchen.

Wash Cycle

Wash Cycle - Overview

The ELXC Series is referred to as a clean in place Ventilator as it has automatic Wash Cycles that washes away the extracted grease within the Extractors, Plenum and surrounding areas, with hot, detergent injected water. The grease is flushed down into the Grease Gutter which slopes to a drain line which leads to the building drain system.

The Ventilator has two wash manifolds, the Extractor Wash Manifold, to wash accumulated grease out of the Extractors, and the Plenum Wash Manifold to wash the accumulated grease out of the Plenum area (Refer to Figure 2-4-1 and 2-4-2). The two manifolds are independently connected to the Wash Control Cabinet, Figure 2-2-1, typically located in, or near the kitchen (Refer to Figure A-5-1 in the Appendix on page A-5 for a typical arrangement of the Wash Control Cabinet and Ventilator). The Wash Control Cabinet houses the Command Center, valves, detergent pump, detergent tank and other plumbing components needed to operate the Wash Cycles. (Refer to Figure 2-15-1 on page 2-15 for a detailed illustration of the Wash Control Cabinet). Two electric solenoid valves are located on the top of or near the top of each Ventilator section (Refer to Figure A-5-1).

Wash Cycle Sequence

The two wash manifolds, Extractor Wash and Plenum Wash, operate independently of each other as the Extractor, Grease Canal and Grease Gutter typically need washing more frequently than the Plenum area. Timers in the Command Center are programmed to initiate either the Extractor Wash or Plenum Wash based on the number of hours the exhaust fan has been on.

ELXC Series - Cont.

Wash Cycle Sequence – Cont.

The frequency and the length of the Wash Cycle is determined by the type of cooking equipment involved; Light Duty, Light/Medium Duty, Medium Duty, Heavy Duty, and Extra Heavy Duty. Refer to Table T-2-16-1, Typical Example of Frequency and Length of Wash Cycles, on page 2-16 for typical application. Washing the Ventilator based on hours of operation for specific Duties of equipment provides the optimum in cleaning performance with the lowest possible water and detergent consumption.

Wash Cycle Example

Extractor Wash Cycle – The Extractor Wash Cycle only comes on while the exhaust fan is on, typically during cooking (Refer to Figure 2-4-1). Using Table T-2-16-1 on page 2-16, if the cooking equipment under the Ventilator is Heavy Duty then the Extractor Wash would come on every 4 hours of fan operation, stay on for 3 minutes and then shut off. Refer to page 2-15 for additional details on the wash cycles.

Plenum Wash Cycle - The Plenum Wash Cycle only comes on while the exhaust fan is off (Refer to Figure 2-4-2). Using Table T-2-16-1 on page 2-16, if the cooking equipment under the Ventilator is Heavy Duty then the Plenum Wash would come on every 16 hours of exhaust fan operation, stay on for 3 minutes and then shut off. Typically the Plenum Wash Cycle will begin, if the number of fan on hours has been satisfied, immediately after the exhaust fan has been shut off. Refer to page 2-15 for additional details on the Wash Cycles.

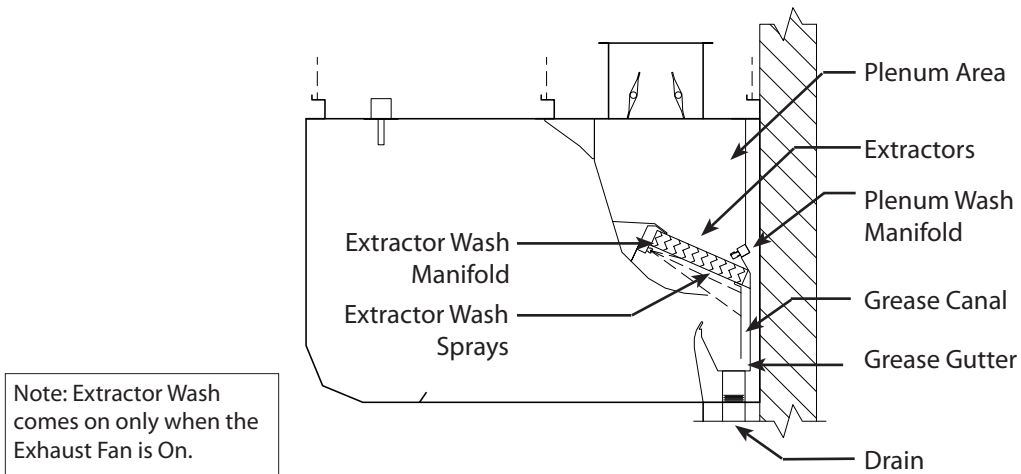

Figure 2-4-1
Extractor Wash On

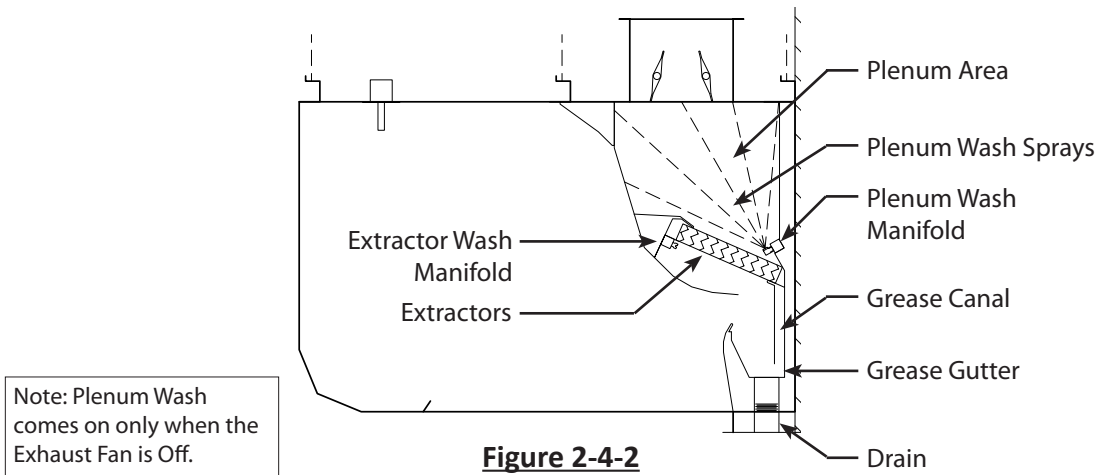

Figure 2-4-2
Plenum Wash On

ELXC Series - Cont.

Fire Protection

Fire Damper

The ELXC Series Ventilator may be equipped with a combination Gaylord Fire/Balancing Damper, designated “GFBD” in the Ventilator model number. If equipped, a 250°F. thermostat will be mounted at the entrance of the exhaust duct collar (Refer to Figure 2-6-1). In the event of a fire and if the thermostat reaches 250 ° F., the following will occur:

1. The fire damper will close preventing fire from extending into the exhaust duct and fan.
2. The exhaust and supply fans will shut off.
3. If the Ventilator was in a Wash Cycle it would shut off.
4. If the Command Center is wired to a building fire alarm system the alarm will activate.
5. If the Command Center is wired to a building management system it will notify of a fire condition.
6. Once the thermostat cools below its set point, the exhaust and supply fans can be re-started by pushing “**START FAN**” on the Command Center.

Fire Extinguishing Systems

The National Fire Protection Association Standard 96 (NFPA-96) and the International Fire Code (IFC) requires the use of a Fire Extinguishing System to cover the cooking surfaces, Ventilator exhaust plenums (the area behind the grease extractors), and the exhaust duct (Refer to Figure 2-6-1). Upon activation of the Fire Extinguishing System the follow will occur:

1. Fire extinguishing agent will discharge through the cooking equipment nozzles, the plenum nozzles and the duct nozzle(s).
2. The protected cooking equipment and possibly other cooking equipment will shut off. Refer to the above referenced codes for specific equipment that must shut off.
3. If the Fire Extinguishing System is wired to a building fire alarm system the alarm will activate.
4. If the Fire Extinguishing System is wired to a building management system it will notify of a fire condition.
5. The Fire Extinguishing System should be wired to the Gaylord Command Center. If it is, the following will occur:
 - a) If the exhaust and supply fan were on the exhaust fan would stay on and the supply fan would shut off. If the exhaust and supply fans were off, the exhaust fan would come on and the supply fan would stay off.
 - b) If the Ventilator Wash Cycle was on it would shut off.
 - c) If the Ventilator is equipped with a Gaylord Electric Balancing Damper (model GEBD) or a Gaylord Fire/Balancing Damper (model GFBD) the damper will open.
6. After discharge, the Fire Extinguishing System must be recharged and certified by a fire system contractor and all extinguishing agent cleaned up before the cooking equipment can be turned back on.

For Operation and Maintenance of the Fire Extinguishing System, refer to the system manufacture’s Owner’s Manual.

Important: NFPA-96 requires inspection and certification of fire systems every 6 months.

ELXC Series - Cont.

When a Fire Extinguishing System discharges, the Balancing Damper remains open or opens if it was closed. If equipped with a Model GFBD Damper and the thermostat activates, the damper closes.

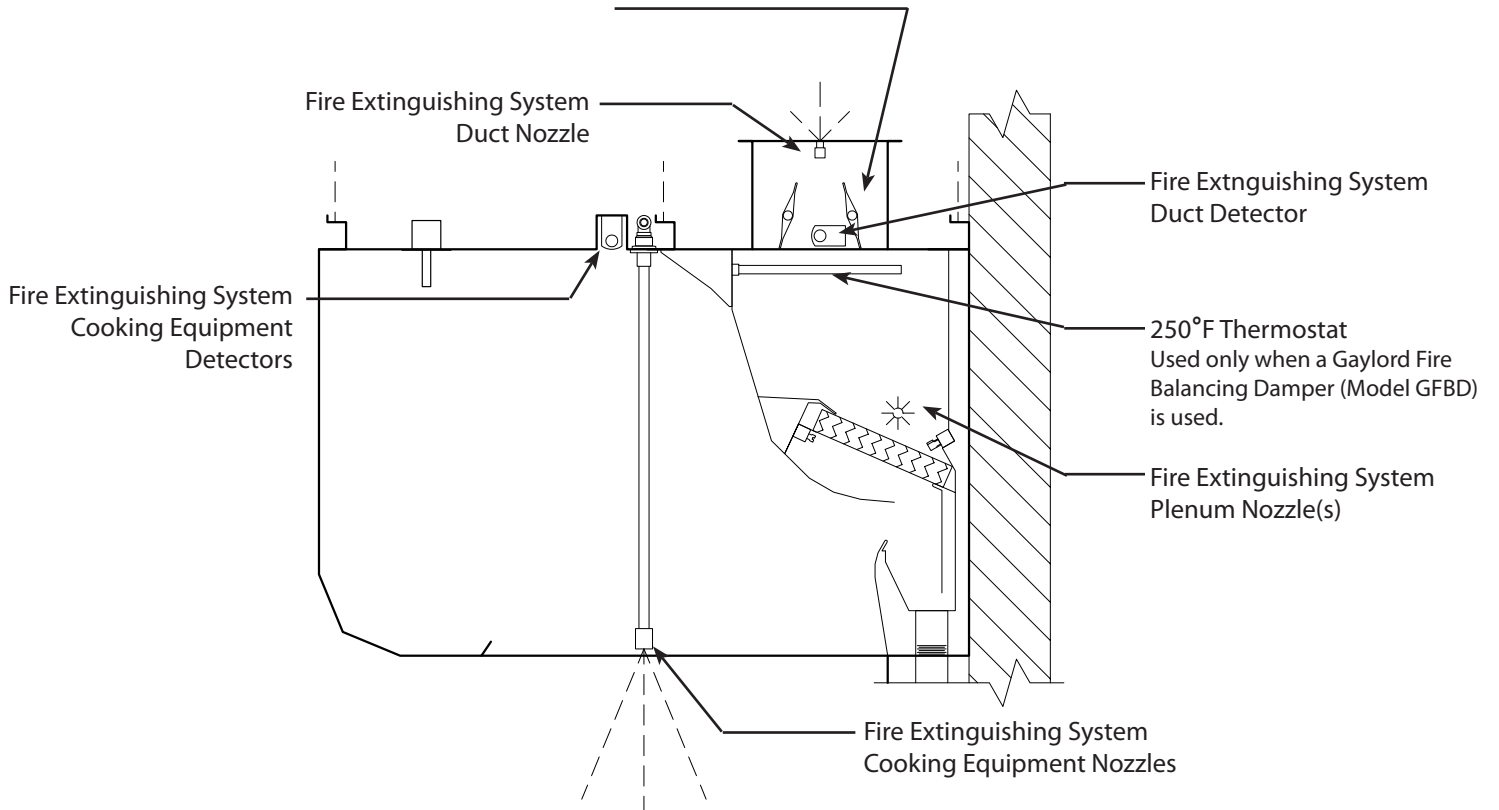

*Illustration shows Fire Extinguishing System discharging.

Figure 2-6-1
Fire Extinguishing System Discharge

ELXC-UVi Series

Ultraviolet Systems (UV)

Overview

Ventilators incorporating UV Lamps are designated Model ELXC-UVi Series Ventilators. UV Systems are used to remove a high percentage of grease that the Extractors cannot remove, offering many benefits to the owner/operator. The UV Lamps are mounted in a UV Module which slide into a track downstream (after) the XGS Extractors (refer to Figure 2-10-1). The electronics and ballasts for UV System are mounted in a UV Ballast Box which is located on the top of the Ventilator (refer to Figure 2-10-1). The ELXC-UVi Ventilator is equipped with UV Status Lights to monitor the status of the UV System, and Safety Interlocks to protect operators from exposure to UV light (refer to Figure 2-8-1).

For proper UV operation, the Ventilators must be maintained in good working order. The UV system must be inspected periodically and the lamps replaced as necessary. The Ventilator, ductwork and exhaust fan must be inspected in accordance with NFPA-96 or local guidelines, though frequency of duct cleanings should be significantly reduced.

UV Safety

Caution: Exposure to UV light is harmful to skin and eyes.

The ELXC-UVi Ventilator is equipped with panels and Safety Interlocks to protect operators from direct exposure to UV light. All safety precautions called for in this manual must be followed to avoid the potential for harm to operators or service personnel. Refer to Page 3-3 for complete description of safety precautions.

Turning On the Exhausting Fan and UV System

Caution: Always turn on the exhaust fan before turning on the cooking equipment.

Caution: The chemical fire extinguishing system may discharge if the exhaust fan is not on while the cooking equipment is on or still hot.

Caution: Never operate the Ventilator without the XGS Extractors in place or the Extractor Access Doors open (Refer to Figure 2-10-1).

Operation of the exhaust fan and UV Lamps is controlled by the Gaylord Command Center (refer to Figure 2-9-1). To start the exhaust fan and turn on the UV Lamps push the **"START FAN"** button on the Command Center. The Command Center control may be programmed to automatically start the exhaust fan at a specific time. Refer to the Operation and Maintenance Manual for the Gaylord Command Center for complete operating instructions of the Command Center.

Note 1: The ELXC-UVi Series Ventilator may be equipped with a Gaylord Electric Balancing Damper, designated "GEBD" in the Ventilator model number, or a Gaylord combination Fire/Balancing Damper, designated "GFBD" in the model number. The Ventilator model number can be found on the Ventilator Nameplate (Refer to page 2-19 for information on Balancing Dampers and page 5-11 for a sample of the Nameplate). If the Ventilator includes one of these dampers, when the fan is started the damper moves from the closed to open position, and it will take approximately 45 seconds for the exhaust to come up to 100%.

ELXC-UVi Series - Cont.

Turning On the Exhausting Fan and UV System – Cont.

Note 2: Typically ELXC-UVi Series Ventilators installed in the United States are equipped with a Gaylord Autostart Controller that automatically turns on the exhaust fan if the temperature at the sensors mounted in the canopy exceeds 90°F. (Refer to Figure 2-10-1). In some instances Ventilators installed outside the United States will include an Autostart Control. Inclusion of an Autostart Control is designated by the suffix “AS” or “DCA” in the model number. The Ventilator model number can be found on the Ventilator Nameplate (Refer to page 5-11 for a sample of the Nameplate). Refer to the Operation and Maintenance Manual for the Gaylord Command Center for complete information on the Autostart Control.

Note 3: The UV Lamps will not come on unless all the XGS Extractors are in place and the Extractor Access Doors are closed as shown in Figure 2-10-1 and 2-10-2.

Note 4: The UV Lamps will not come on unless all the UV Module Access Doors are closed and latched as shown in Figure 2-10-2.

Note 5: The UV Lamps will not come on unless the exhaust fan is running.

UV Status Lights

Each Ventilator section contains a bank of UV Status Lights to monitor the UV System (refer to Figure 2-8-1). There are three colored lights, Blue, Yellow and Green. They indicate the system status as follows:

1. Green On: The UV system is operating properly.
2. Yellow On: One or more UV Lamps are not operating. If the yellow is on, less UV is being generated, however it does not prevent the operation of the Ventilator or indicate an unsafe condition.
3. Blue On: One or more XGS Extractors are not in place and/or one or more UV Module Access Doors are not closed properly, or the internal temperature of the Ballast Box has exceeded 118° F. which activates the High Temperature Shutdown Controller. During this mode the UV System is not operating and is in a UVi System Standby mode until the cause has been corrected.

In addition to the Status Lights on the Ventilator, the Gaylord Command Center displays text indicating a similar message as the Status Lights. Refer to the Operation and Maintenance Manual for the Gaylord Command Center for complete operational instructions.

Note: If either the Yellow or Blue light are on refer the Troubleshooting section of this manual beginning on page 4-1 for corrective action.

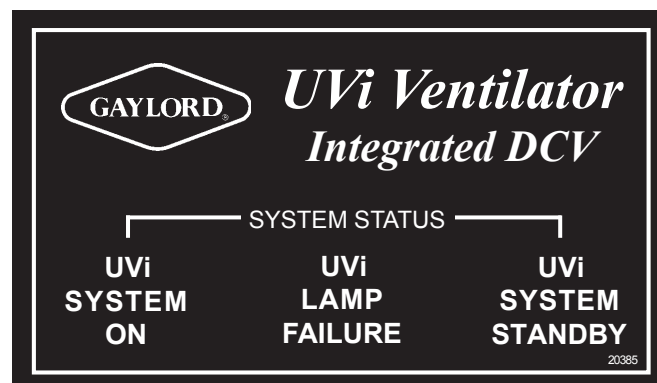

Figure 2-8-1
UV Status Lights

ELXC-UVi Series - Cont.**Grease Extraction**

Grease is removed from the exhaust air by combination of the Gaylord Model XGS Extractors and the UV Lamps (Refer to Figure 2-10-1). The hot contaminate-laden air rising from the cooking surface enters the inlet slot, turns and is drawn through the Extractors where a high percentage of the grease and other particulate are extracted from the airstream. As the air enters the Plenum chamber, the grease particles are exposed to the ultraviolet light which oxidizes the particles into a light gray powder which are deposited on the Lamps, the Plenum chamber and in the exhaust duct. Some powder may exhaust out the exhaust fan.

The extracted liquid grease will drain down the Extractors and into the Grease Canal which then drains down into the Grease Gutter. The sticky grease will remain in the Extractors. The Extractors, Grease Canal and Grease Gutter are power washed periodically, while the exhaust fan is on, by the automatic Extractor Wash Cycle. The UV Lamps are also washed periodically during a Plenum Wash Cycle. Refer to page 2-11 for details on the Wash Cycles.

The Gaylord Industries Model XGS Extractor is designed to deliver the absolute optimum in collection efficiency at the lowest possible pressure drop. The Extractors are ETL Recognized as part of the ELXC-UVi Ventilator. They are constructed of corrosion resistant stainless steel.



Figure 2-9-1
Wash Control Cabinet

ELXC-UVi Series - Cont.

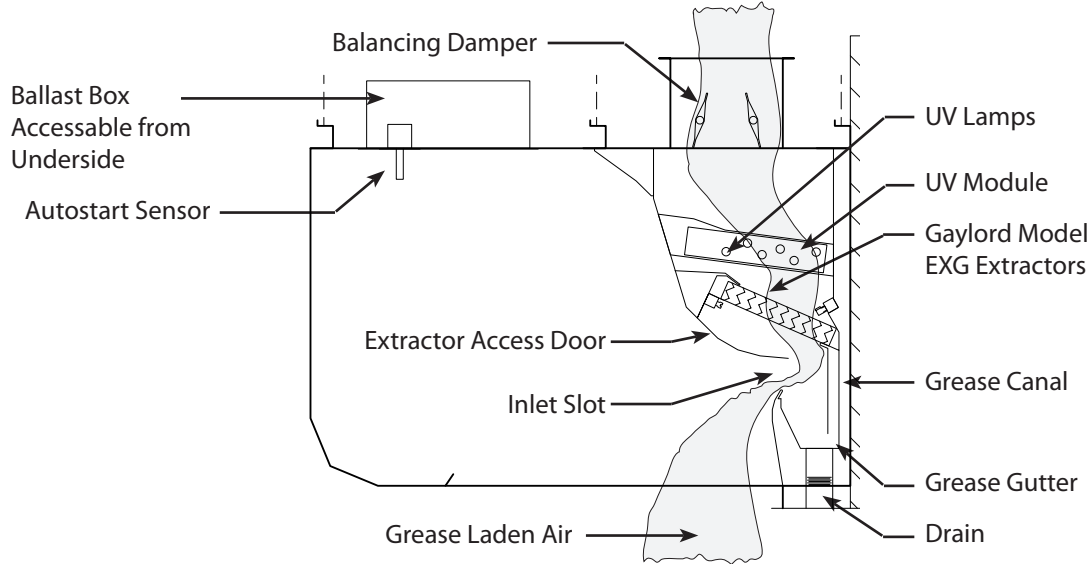

Figure 2-10-1
Grease Extraction

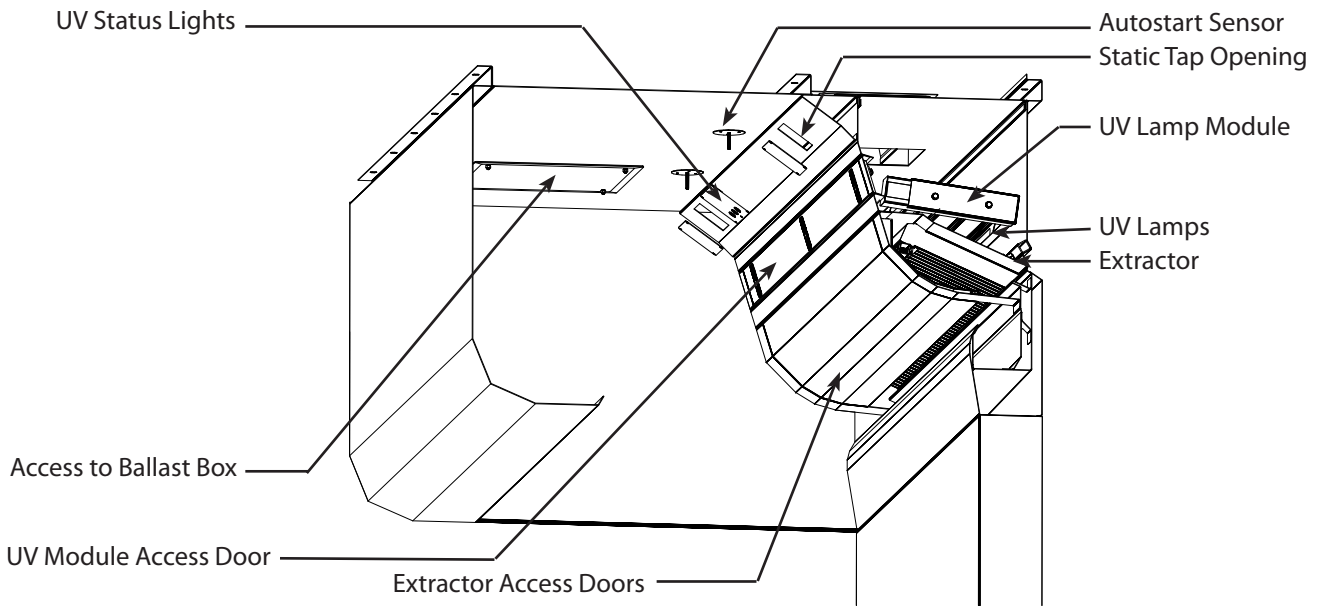

Figure 2-10-2
Model ELXC-UVi Series Cutaway

Turning Off the Exhaust Fan

Caution: Always turn off the cooking equipment and allow to cool before turning off the exhaust fan. The chemical fire extinguishing system may discharge if the cooking equipment is on or hot when the exhaust fan is off.

At the end of the cooking day, turn off the cooking equipment and allow to cool before turning off the exhaust fan. To turn off the exhaust fan and UV Lamps push the **“STOP FAN”** button on the Gaylord Command Center (Refer to Figure 2-9-1). The Command Center control may be programmed to automatically turn off the exhaust fan at a specific time. Refer to the Operation and Maintenance Manual for the Gaylord Command Center for complete operating instructions.

ELXC-UVi Series - Cont.

Turning Off the Exhaust Fan - Cont.

Note 1: If the Ventilator is equipped with a Gaylord Autostart Controller, the exhaust fan will stay on if the temperature at the sensor mounted in the canopy exceeds 90°F. (Refer to Figure 2-10-1). Once the temperature drops below 90°F., the fan will continue to run for 15 minutes and then shut off.

Note 2: If the Ventilator is equipped with a Gaylord Electric Balancing Damper, designated “GEBD” or a Gaylord combination Fire/Balancing Damper, designated “GFBD”, when the fan is turned off the damper will move from the open to closed position and remain closed until the exhaust fan is re-started. Closing the damper saves building energy by not allowing conditioned air from drafting up the exhaust duct, or in cold climates prevents cold air from coming down the duct and into the kitchen.

Wash Cycle

Overview

The ELXC-UVi Series is referred to as a clean in place Ventilator as it has automatic Wash Cycles that washes away the extracted grease within the Extractors, UV Lamps, Plenum and surrounding areas, with hot, detergent injected water. The grease is flushed down into the Grease Gutter which slopes to a drain line which leads to the building drain system.

The Ventilator has two wash manifolds, the Extractor Wash Manifold, to wash accumulated grease out of the Extractors, and the Plenum Wash Manifold to wash the accumulated gray powder, created by oxidation of the grease by the UV Lamps, out of the Plenum area (Refer to Figure 2-12-1 and 2-12-2). The two manifolds are independently connected to the Wash Control Cabinet typically located in, or near the kitchen (Refer to Figure A-5-1 in the Appendix on page A-5 for a typical arrangement of the Wash Control Cabinet and Ventilator). The Wash Control Cabinet houses the Command Center, valves, detergent pump, detergent tank and other plumbing components needed to operate the Wash Cycles (Refer to Figure 2-15-1 on page 2-15 for a detailed illustration of the Wash Control Cabinet). Two electric solenoid valves are located on the top of or near the top of the Ventilator (Refer to Figure A-5-1).

Wash Cycle Sequence

The two wash manifolds, Extractor Wash and Plenum Wash, operate independently of each other as the Extractor, Grease Canal and Grease Gutter typically need washing more frequently than the UV Lamps and Plenum area.

Timers in the Command Center are programmed to initiate either the Extractor Wash or Plenum Wash based on the number of hours the exhaust fan has been on. The frequency and the length of the Wash Cycle is determined by the type of cooking equipment involved; Light Duty, Light/Medium Duty, Medium Duty, Heavy Duty, and Extra Heavy Duty. Refer to Table T-2-16-1, Typical Example of Frequency and Length of Wash Cycles, on page 2-16 for typical application. Washing the Ventilator based on hours of operation for specific Duties of equipment provides the optimum in cleaning performance with the lowest possible water and detergent consumption.

ELXC-UVi Series - Cont.

Wash Cycle Sequence – Cont.

Wash Cycle Example

Extractor Wash Cycle – The Extractor Wash Cycle only comes on while the exhaust fan is on, typically during cooking (Refer to Figure 2-12-1). Using Table T-2-16-1 on page 2-16, if the cooking equipment under the Ventilator is Heavy Duty then the Extractor Wash would come on every 4 hours of fan operation, stay on for 3 minutes and then shut off. Refer to page 2-15 for additional details on the wash cycles.

Plenum Wash Cycle - The Plenum Wash Cycle only comes on while the exhaust fan is off (Refer to Figure 2-12-2). Using Table T-2-16-1 on page 2-16, if the cooking equipment under the Ventilator is Heavy Duty then the Plenum Wash would come on every 16 hours of exhaust fan operation, stay on for 3 minutes and then shut off. Typically the Plenum Wash Cycle will begin, if the number of fan on hours has been satisfied, immediately after the exhaust fan has been shut off. Refer to page 2-15 for additional details on the Wash Cycles.

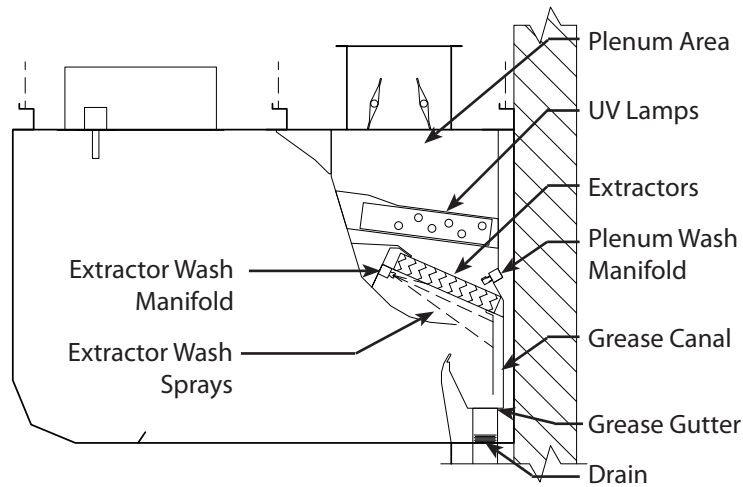

Note: Extractor Wash comes on only when the Exhaust Fan is On.

Figure 2-12-1
Extractor Wash On

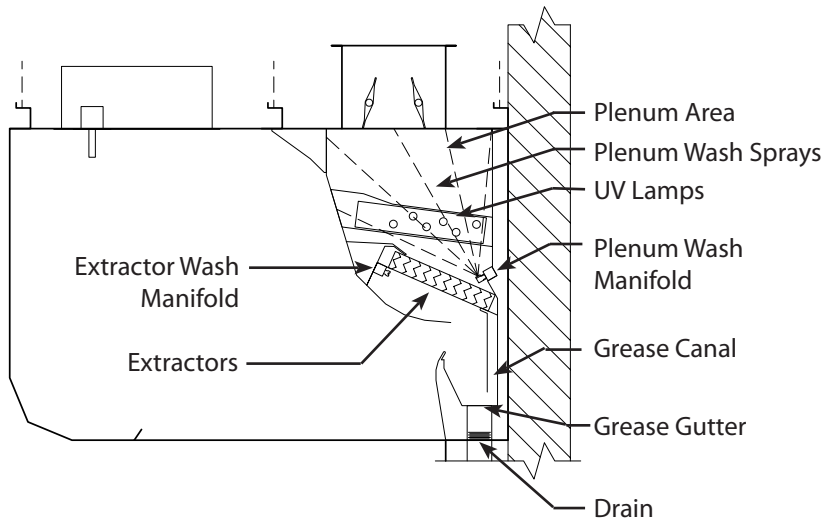

Note: Plenum Wash comes on only when the Exhaust Fan is Off.

Figure 2-12-2
Plenum Wash On

ELXC-UVi Series - Cont.

Fire Protection

Fire Damper

The ELXC-UVi Series Ventilator may be equipped with a combination Gaylord Fire/Balancing Damper, designated "GFBD" in the Ventilator model number. If equipped, a 250°F. thermostat will be mounted at the entrance of the exhaust duct collar (Refer to Figure 2-14-1). In the event of a fire and if the thermostat reaches 250°F., the following will occur:

1. The fire damper will close preventing fire from extending into the exhaust duct and fan.
2. The exhaust and supply fans will shut off.
3. The UV Lamps will shut off.
4. If the Ventilator was in a Wash Cycle it would shut off.
5. If the Command Center is wired to a building fire alarm system the alarm will activate.
6. If the Command Center is wired to a building management system it will notify of a fire condition.
7. Once the thermostat cools below 250°F., plus a 5 minute cool down, the exhaust and supply fans can be re-started by pushing the "**START FAN**" on the Command Center.

Fire Extinguishing Systems

The National Fire Protection Association Standard 96 (NFPA-96) and the International Fire Code (IFC) requires the use of a Fire Extinguishing System to cover the cooking surfaces, Ventilator exhaust plenums (the area behind the grease extractors), and the exhaust duct (Refer to Figure 2-14-1). Upon activation of the Fire Extinguishing System the follow will occur:

1. Fire extinguishing agent will discharge through the cooking equipment nozzles, the plenum nozzles and the duct nozzle(s).
2. The protected cooking equipment and possibly other cooking equipment will shut off. Refer to the above referenced codes for specific equipment that must shut off.
3. If the Fire Extinguishing System is wired to a building fire alarm system the alarm will activate.
4. If the Fire Extinguishing System is wired to a building management system it will notify of a fire condition.
5. The Fire Extinguishing System should be wired to the Gaylord Command Center. If it is, the following will occur:
 - a) If the exhaust and supply fan were on the exhaust fan would stay on and the supply fan would shut off. If the exhaust and supply fans were off, the exhaust fan would come on and the supply fan would stay off.
 - b) If the Ventilator Wash Cycle was on it would shut off.
 - c) If the Ventilator is equipped with a Gaylord Electric Balancing Damper (model GEBD) or a Gaylord Fire/Balancing Damper (model GFBD) the damper will open.
 - d) If the ventilator is equipped with UV Lamps, the lamps will shut off.
6. After discharge, the Fire Extinguishing System must be recharged and certified by a fire system contractor before the cooking equipment can be turned back on.

For Operation and Maintenance of the Fire Extinguishing System, refer to the system manufacture's Owner's Manual.

Important: NFPA-96 requires inspection and certification of Fire Extinguishing Systems every 6 months.

ELXC-UVi Series - Cont.

Fire Protection - Cont.

When a Fire Extinguishing System discharges, the Balancing Damper remains open or opens if it was closed. If equipped with a Model GFBD Damper and the thermostat activates, the damper closes.

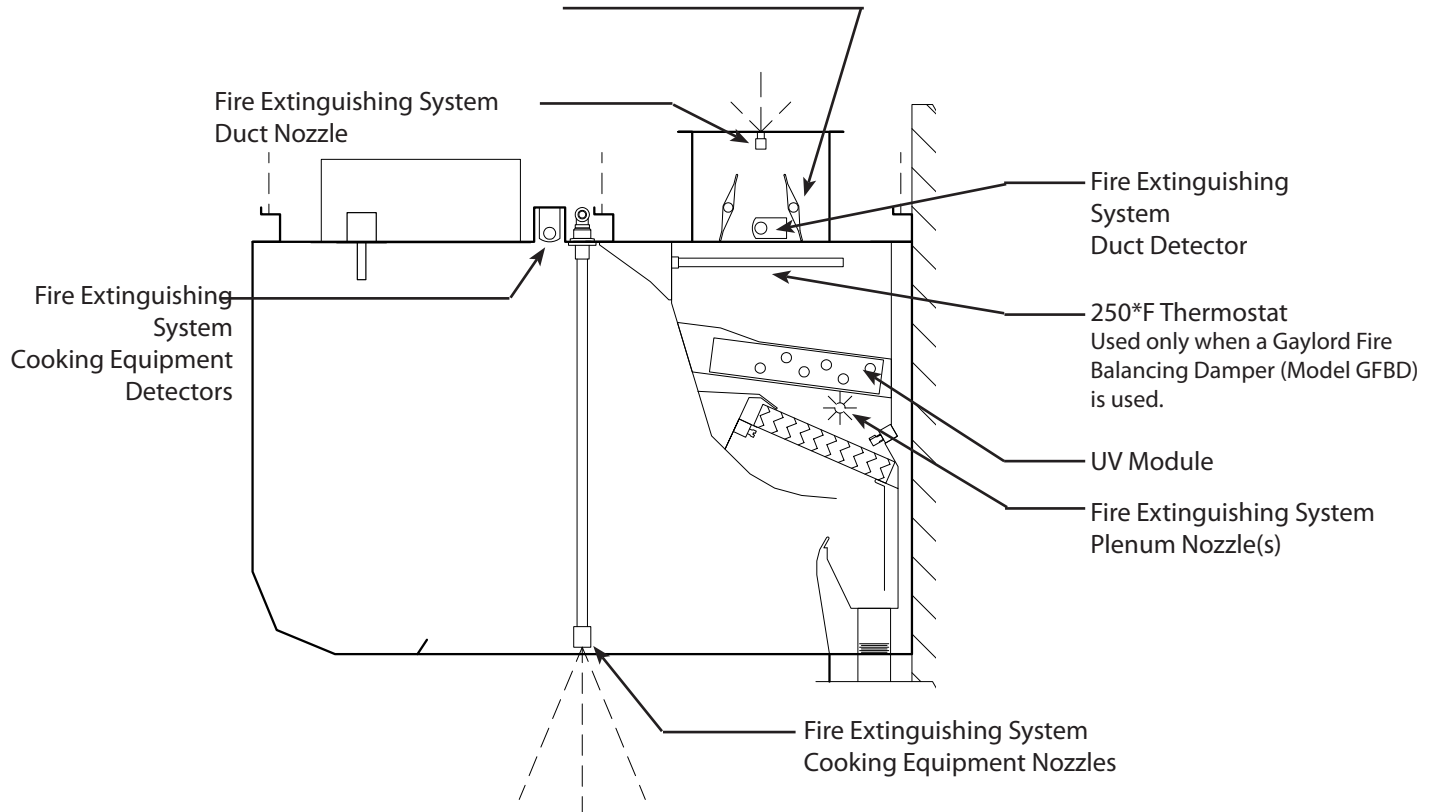

*Illustration shows Fire Extinguishing System discharging.

Figure 2-14-1
Fire Extinguishing System Discharge

Wash System

Wash System

Overview

The wash system is controlled by the Gaylord Command Center. The Command Center is mounted in the Wash Control Cabinet which houses the valves, detergent pump, detergent tank and other plumbing components needed to operate the Wash Cycles (refer to Figure 2-15-1). In addition, two solenoid valves are located on the top or near the top of each Ventilator section (refer to page A-5-1 for an illustration).

The two Ventilator wash manifolds, Extractor Wash and Plenum Wash, operate independently of each other as the Extractor, Grease Canal and Grease Gutter typically need washing more frequently than the Plenum area. Timers in the Command Center are factory programmed to initiate either the Extractor Wash or Plenum Wash based on the number of hours the exhaust fan has been on. The Extractor Wash always comes on while the exhaust fan is on and the Plenum Wash always comes on while the exhaust fan is off.



Figure 2-15-1
Wash Control Cabinet

Frequency and Length of Wash

The frequency and the length of the Wash Cycles are primarily determined by the type of cooking equipment involved; Light Duty, Light/Medium, Medium Duty, Heavy Duty, and Extra Heavy Duty as shown Table T-2-16-1. The number of hours before the Wash Cycle starts, and the length of the Wash Cycle, are based on average conditions. Table T-2-16-1 shows an example of typical frequencies and length of the wash times. Actual frequency and times necessary to adequately clean the Ventilator may vary depending on the following:

1. Actual amount of cooking within the hours of fan operation.
2. Type of food product being cooked.
3. Water pressure. Required pressure is 40 psi Min. to 80 psi Max.
4. Water temperature. Required temperature is 140 degrees F. Min. to 180 degrees F. Max.
5. Type of detergent. Refer to page 2-17 for recommend detergent.
6. Ratio of detergent to water.

The number of Hours of Fan Operation and the Length of the Wash Cycle are programmed in the Command Center. The length of the Wash Cycle, for the Extractor and the Plenum, can be increased or decreased, independently, as needed to adequately clean the Ventilator. The minimum wash time is 3 minutes and maximum is 10 minutes. The Hours of Fan Operation are factory set and cannot be changed however the Duty of the cooking equipment can be changed to either increase or decrease the Hours of Fan Operation

Wash System - Cont.

Frequency and Length of Wash - cont.

before a Wash Cycle comes on. As an example, if you have Medium Duty equipment and the Ventilator is not washing adequately, the Command Center may be re-programmed, for either the Extractor Wash and/or Plenum Wash, to Heavy Duty, reducing the Hours of Fan Operation for the Extractor Wash from 12 hours to 4 hours and the Plenum Wash from 36 hours to 16 hours. Refer to the Operation and Maintenance Manual for the Gaylord Command Center for instructions on programming the times. Refer to the Troubleshooting section page 4-2 for possible causes of inadequate cleaning.

Table T- 2-16-1

Typical Example of Frequency and Length of Wash Cycles per Ventilator Section				
Type of Cooking Equipment	Extractor Wash		Plenum Wash	
	Hours of Fan Operation Before Wash Starts (Factory Set)	Length of Wash Cycle (in min.)	Hours of Fan Operation Before Wash Starts (Factory Set)	Length of Wash Cycle (in min.)
Light Duty	84	3	98	3
Ovens, steamers and kettles				
Light / Medium Duty	42	3	72	3
Braising pans, tilting skillets, fryers, open burner ranges, hot top ranges, and conveyor ovens				
Medium Duty	12	3	36	3
Griddles, grooved griddles				
Heavy Duty	4	3	16	3
Gas and electric char broilers, upright broilers, woks and conveyor broilers				
Extra Heavy Duty	2	3	6	3
Solid fuel broilers				

Ventilator Section Wash Groups

The hot water pipe exiting the Wash Control Cabinet control is called the Main Feed Pipe. The Main Feed Pipe is routed to the top of the Ventilator and then “tees” to two solenoid valves, one for the Extractor Wash and one for the Plenum Wash (refer to page A-5 for an illustration). If there are two or more Ventilator sections, the Main Feed Pipe branches off and is routed to each section where it connects to the two solenoid valves. Each Ventilator section washes independently of each other so that, for example, a Ventilator over

Wash System - Cont.

Ventilator Section Wash Groups - cont.

Heavy Duty equipment would wash at a different frequency than a Ventilator covering Light/Medium Duty equipment, as shown in the example Table T-2-16-1. The length of each Wash Cycle, for each Ventilator section, is programmed in the Command Center. If two or more Ventilator sections have the same cooking equipment Duty, at the conclusion of the Wash Cycle for Ventilator section # 1, either an Extractor Wash or Plenum Wash, the Wash Cycle for Ventilator section #2 would immediately begin or it can be delayed by programming the Command Center. The delay can be programmed for up to 99 minutes. Refer to the Operation and Maintenance Manual for the Gaylord Command Center for complete programming instructions.

Table T-2-17-1

Hot Water Requirements		
Water Temperature: 140 °F Min. to 180 °F Max.		
Flow Pressure: 40 PSI Min. - 80 PSI Max. at the Wash Control Cabinet while in a Wash Cycle		
Water Consumption Table		
Type of Wash	GPM Per Lineal Ft. of Ventilator	
	@40 PSI *	@80 PSI *
Extractor Wash	0.51	0.72
Plenum Wash	0.45	0.63
* All Pressures Measured at the Wash Control Cabinet with no more than 30 ft. of 1" pipe line between the Ventilator and Wash Control Cabinet		

Recommended Detergent

FORMULA G-510EF is the only cleaner recommended by Gaylord Industries for use in the wash down system of The Gaylord Ventilator. FORMULA G-510EF is a concentrated colloid cleaner specially formulated to remove the daily accumulation of grease inside the Ventilator without damaging the rubber and synthetic parts of the solenoid valves and the detergent pumping system. FORMULA G-510EF is safe for kitchen personnel and has a variety of uses.

FORMULA G-510EF Safety

FORMULA G-510EF is registered with the U.S. EPA's Design for the Environment Program (DfE) which seeks to promote the use of institutional cleaners and maintenance products with improved environmental and human health characteristics.

FORMULA G-510EF for the Ventilator Wash System

Pour FORMULA G-510EF directly into the detergent tank located inside the Wash Control Cabinet (Refer to Figure 2-11-2). The detergent pump injects the detergent into the Main Feed Line where it dilutes with the hot water at the proper ratio (Refer to Figure 2-11-2).

FORMULA G-510EF for Cleaning the Ventilator Exterior

Mix one part FORMULA G-510EF to twenty parts water in hand spray bottle. Spray on, let stand for a few minutes and wipe off.

FORMULA G-510EF for Other Cleaning Jobs

The colloidal action of FORMULA G-510EF makes it a cleaner especially well-suited for use in kitchens. The colloids break up dirt and grease into millions of tiny particles that constantly repel each other. These particles cannot recombine or redeposit on a surface and are, therefore, easily washed away. FORMULA G-510EF contains no harsh chemicals, yet offers outstanding performance on the toughest cleaning jobs.

Wash System - Cont.

Use a mixture of one part FORMULA G-510EF to twenty parts water for:

- VINYL/PLASTIC/WALLS...Removes dirt, grease, food deposits and fingerprints.
- REFRIGERATORS...Removes dirt, spilled milk, blood, mildew and objectionable odors.
- RESTROOMS...Add a disinfectant to clean all fixtures, walls, floors, etc.

Use a mixture of one part FORMULA G-510EF to five parts water for extremely heavy grease build-up, such as on the floor and on equipment around deep-fryers. Spray on, let set for a few minutes and rinse or wipe off. For extremely soiled areas, gentle agitation, followed by a soaking period, will result in more thorough cleaning. DON'T be afraid to experiment with FORMULA G-510EF because it contains no phosphates, nitrates, enzymes, sulfates, suffocates or silicates.

Limited Warranty

2010 Products, Inc. warrants that Formula G-510EF will not cause cleansing agent damage to the rubber and synthetic parts of the injection pump ("O" rings, diaphragms, washers, tubing, and other such parts) used with The Gaylord Ventilator, Heat Reclaim Unit, or Pollution Control Equipment so long as used pursuant to its product instructions. 2010 Products, Inc. obligation under this warranty and any warranties implied by law shall be limited to repairing or replacing, at its option, any of said parts which 2010 Products, Inc. examination shall disclose to its satisfaction to have been damaged by the use of Formula G-510EF for the life of the detergent pumping system. This warranty shall not cover damages caused by any other detergent. The use of any other detergent shall void this warranty. All repairs and replacement parts under this warranty shall be F.O.B. 2010 Products, Inc. The owner shall pay the necessary freight and delivery charges; also removal and installation costs. Any federal, state or local taxes are also extra. Requests for repairs or replacement part should be made to 2010 Products, Inc., P.O. Box 7609, Salem, Oregon, 97303. This is the sole warranty with respect to FORMULA G510EF.

2010 Products, Inc. MAKES NO OTHER WARRANTY OF ANY KIND WHATSOEVER, EXPRESSED OR IMPLIED, AND ALL IMPLIED WARRANTIES OF MERCHANTABILITY AND FITNESS FOR A PARTICULAR PURPOSE WHICH EXCEED THE AFORESAID OBLIGATION ARE HEREBY DISCLAIMED AND EXCLUDED FROM THIS AGREEMENT. 2010 Products, Inc. SHALL NOT BE RESPONSIBLE FOR INCIDENTAL OR CONSEQUENTIAL DAMAGES RESULTING FROM A BREACH OF THIS WARRANTY.

IMPORTANT

If a cleansing agent other than FORMULA G-510EF is used with The Gaylord Ventilator injection pump and solenoid valves, it is recommended that a warranty similar to the above be obtained from the manufacturer of said product, that the detergent has foaming properties similar to FORMULA G-510EF and that the above-referenced Warranty shall become null and void.

FORMULA G-510EF Distributor

For the name and address of the nearest FORMULA G-510EF distributor contact:

Gaylord Industries
10900 SW Avery Street
Tualatin, OR 97062
E-mail: info@gaylordventilation.com
Website: www.gaylordventilation.com
Phone: 800-547-9696

Balancing Dampers

Balancing Dampers

Balancing Dampers Overview

The ELXC and ELXC-UVi Series Ventilators, as a standard, come with one of three models of Gaylord Industries Listed Balancing Dampers. Balancing dampers would typically be used when two or more Ventilators are connected to a common exhaust fan. The purpose of the balancing damper is to raise or lower the airflow of each Ventilator to achieve the desired exhaust rate. One of the damper models is a combination Fire/Balancing Damper. If the Ventilators include a Balancing Damper the suffix GBD, GEBD or GFBD will be included in the Ventilator model number shown on the Ventilator Nameplate. Refer to Figure 5-4-1 on page 5-4 for an example of the nameplate.

The three damper models available are as follows:

1. Model GBD (Gaylord Balancing Damper) is a manually adjusted balancing damper with internal setting (refer to Figure 2-20-2). Adjustment is made by removing the Extractor under the exhaust duct collar and reaching up with a wrench to the Adjusting Nut. The nut is loosened, dampers manually adjusted and the Adjusting Nut retightened.
2. Model GEBD (Gaylord Electric Balancing Damper) is an electrically adjusted balancing damper (Refer to figure 2-20-1). Adjustment is made by use of a potentiometer, one for each damper, mounted in a junction box located in the roof of the Ventilator (Refer to figure 2-20-3). The GEBD is set up to automatically close upon shutting off the exhaust fan every night. This feature prevents conditioned air from exiting the building through the Ventilator. In the event of a power failure the damper will automatically open.
3. Model GFBD (Gaylord Fire / Balancing Damper) is a combination thermostatically activated fire damper/ electrically adjusted balancing damper. With this option one or more thermostats are mounted in the exhaust duct collar of the Ventilator (Refer to Figure 2-6-2). The thermostats are factory set for 250°F., and in the event of a fire when the thermostat(s) reach 250°F., the damper will close to prevent fire from extending into the ductwork and up to the exhaust fan. Adjustment for balancing of the system is made by use of a potentiometer, one for each damper, mounted in a junction box located in the roof of the Ventilator (Refer to figure 2-20-3). The GEBD is set up to automatically close upon shutting off the exhaust fan every night. This feature prevents conditioned air from exiting the building through the ventilator. In the event of a power failure the damper will automatically open.

Adjustment

The adjustment of all the models relies on the internal dimension between the two blades called the Damper Set Dimension, "DSD" (Refer to Figure 2-20-2). The manipulation of this distance will balance the airflow between multiple section Ventilators. Refer to the Measuring Airflow section beginning on page 5-1 for more details.

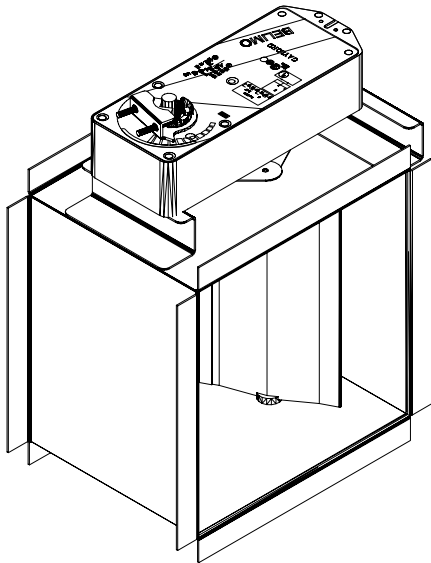

Figure 2-20-1
Typical Model GEBD
Other Models Look Similar
Except Without the Motor

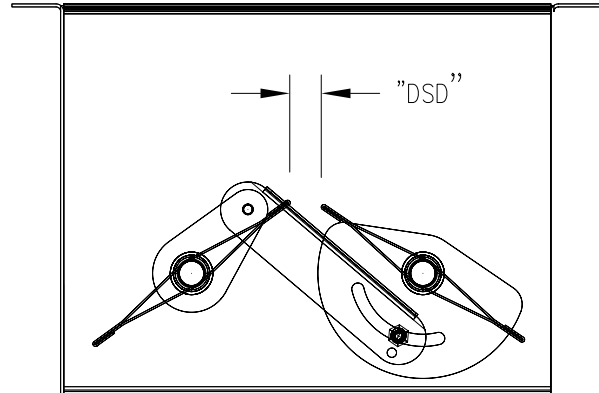

Figure 2-20-2
Section View of Model GBD
The Dampers and the DSD
are the same for all Models

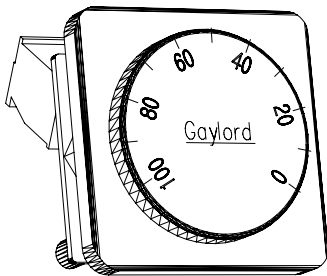

Figure 2-20-3
Potentiometer

(%) OPEN	DSD (in)
100	4-1/16
90	3-7/8
80	2-15/16
70	2-1/8
60	1-1/2
50	15/16
40	3/8

Table 2-20-1
Electric Damper Correlation Chart

Operator Preventive Maintenance

Operator Preventive Maintenance

Overview

To maintain the Gaylord Ventilator in good working order and to keep the system operating at optimum efficiency, preventive maintenance, using the following schedule, should be performed.

Important Note: Ventilators incorporating UV Lamps require special maintenance as shown on page 3-3. Some of the required maintenance on Ventilators with UV can be performed by the operator. However, direct exposure to UV light is hazardous to your skin and eyes and contact with live electrical components poses a significant risk of shock or death.

Recommended Scheduled Maintenance

Daily

If equipped with UV, make sure the green “UV System On” lamp on the Ventilator is on when the exhaust fan is on. If the light is not on refer to the Troubleshooting procedures on Page 4-3.

For general cleanliness the underside of the Ventilator should be wiped down as shown in Figure 3-2-2.

Weekly

The Detergent Tank, located in the Wash Control Cabinet, should be checked and kept full with detergent. Refer to Page 2-17 for recommend detergent.

Monthly

1. The detergent fittings should be checked. This is an airtight system and fittings should be tight. For complete details on the Detergent Pump refer to the Operation and Maintenance manual for the Gaylord Command Center and Wash Control Cabinet.

2. When a wash cycle is not on, open the Extractor Access Doors and remove the Extractors. (Refer to Figure 3-6-1). Check the Extractors and Plenum area to ensure they are adequately cleaned. If the Ventilator includes UV Lamps check to ensure that they are adequately cleaned. If overall cleaning appears to be inadequate, refer to the Troubleshooting procedure on Page 4-2.

3. Check the entire Grease Gutter and Drain Outlet and remove any foreign material such as paper towels, order chits etc. Also check to ensure the gutter is being adequately cleaned by the wash cycle. If overall cleaning appears to be inadequate, refer to the Troubleshooting procedure on Page 4-2.

Every Six Months

1. Check the exhaust fan(s) for belt tightness, belt alignment. Lubricate moving parts as required. Note: A blue lithium based grease is best suited for high heat and speed bearing lubrication.

2. Check for proper velocity at the air inlet slot. Refer to page 5-1 procedures.

3. Clean the Detergent Tank and Foot Valve.

Every 12 Months

Remove the Grease Canal Inspection Plate and check for adequate cleaning (Refer to Figure 2-2-2 on page 2-2). Clean if necessary.

Operator Preventive Maintenance - Cont.

Inspection and Cleaning Requirements

NFPA-96 (Standard for Ventilation Control and Fire Protection of Commercial Cooking Operations) require that hoods (Ventilators), ducts and exhaust fans must be **inspected** by a properly trained, qualified and certified company or person(s) in accordance with the following table.

Table T-3-2-1

EXHAUST SYSTEM INSPECTION SCHEDULE	
Systems serving solid fuel cooking operations	Monthly
Systems serving high-volume cooking operations such as 24-hour cooking, charbroiling or wok cooking	Quarterly
Systems serving moderate-volume cooking operations	Semi-annually
Systems serving low-volume cooking operations, such as churches, day camps, seasonal businesses, or senior centers	Annually

Upon inspection, if found to be contaminated with deposits from grease laden vapors, the entire exhaust system shall be cleaned by a properly trained, qualified, and certified company or person(s) acceptable to the authority having jurisdiction.

When a vent cleaning service is used, a certificate showing date of inspection or cleaning shall be maintained on the premises. After cleaning is completed, the vent cleaning contractor shall place or display within the kitchen area a label indicating the date cleaned and the name of the servicing company. It shall also indicate the area not cleaned. It is good practice to get before and after pictures for quality control purposes.

CAUTION regarding pressure washing or steam cleaning: If the Ventilator includes a UV System the UV Modules must be removed prior to pressure washing or steam cleaning.



Figure 3-2-2
Cleaning

UV System Scheduled Preventive Maintenance

CAUTION: Preventive maintenance and repairs made to the UV System as outlined on pages 3-3 through 3-5 **MUST** be performed by Gaylord Certified Service Agent. For a list of Gaylord Certified Service Agencies (CSA's) visit www.gaylordventilation.com and go to "Service Agencies".

WARNING: Certified Service Agent maintenance and repair warning. Do not defeat any Safety Interlocks during cleaning, maintenance and repair.

Safety Requirements

Caution: Exposure to UV light is harmful to skin and eyes. Before servicing or repairing any of the UV System read and perform the following safety requirements.

Overview

The ELXC-UVi Ventilator is equipped with light attenuation barriers and Safety Interlocks to protect operators from direct exposure to UV light. All safety precautions called for in this manual must be followed to avoid the potential for harm to service personnel or operators.

As with many types of technology if it is not used properly and/or proper precautions are not taken there is the potential for injury or harm. This is especially true of UV light due to the fact that it does not physically hurt at the time of exposure. UV generated in these Ventilators is greater than what results from direct exposure to the sun. Under no circumstances is it acceptable to view the lighted lamps without proper eye protection or expose bare skin directly to the light. All safety precautions called for in this manual must be followed to avoid the potential for harm to service personnel and/or operators.

Personal Protective Equipment

1. Eye protection that prevents 100% of UV light from being transmitted through the lens must be worn at all times when replacing the UV Lamps on any ELXC-UVi Ventilator that is energized and/or has the potential to be energized and expose personnel to UV light.
2. Whenever service work is performed it is recommended that long sleeve shirts and pants be worn to minimize the potential for inadvertent exposure of the skin to UV light.

Preventive Maintenance

The following Preventive Maintenance items must be performed by a trained and qualified Certified Service Agency at a frequency shown on page 3-2, Table T-3-2-1, EXHAUST SYSTEM INSPECTION SCHEDULE. These tasks involve potential exposure to high doses of UV light and live electrical components. There is a risk of shock, injury and/or death from contact with live electrical components.

1. Testing UV Lamps and Ballasts

(For these tests all XGS Extractors must be in place, the Extractor Access Doors closed and all UV Module Access Doors in place and latched.)

- a. Turn on the exhaust fan at the Gaylord Command Center. The "UVi SYSTEM ON" green Status Light in each Ventilator Section should be on. In addition to the Status Lights on the Ventilator, the Gaylord Command Center should display text indicating the similar message as the Status Lights.

UV System Scheduled Preventive Maintenance - Cont.

Testing UV Lamps and Ballasts - Cont.

- b. If the yellow “UVi LAMP FAILURE” Status Light is on it indicates that one or more of the UV Lamps are not operating. To troubleshoot and replace a lamp refer to the Troubleshooting page 4-4, and Testing and Repair section of this manual beginning on page 5-7.
- c. If the blue “UVi SYSTEM STANDBY” Status Light is on it indicates that one or more XGS Extractors are not in place and/or one or more UV Module Access Doors have not been closed properly or the internal temperature of the Ballast Box has exceeded 118° F. which activates the High Temperature Shutdown Controller. Refer to page 4-3 for troubleshooting and corrective action for the Temperature Shutdown Controller.

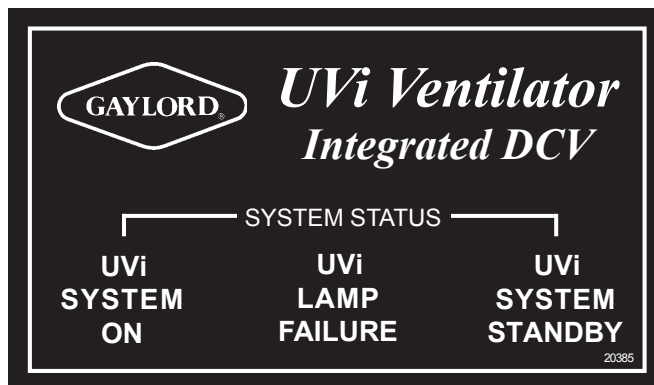

Figure 3-4-1
UV Status Lights

2. Inspect and Clean UV Modules

- a. Turn off the exhaust fan at the Command Center.
- b. Open the UV Module Access Door(s) (refer to Figure 2-10-2).
- c. Disconnect the UV Module Lamp Ballast Connector.
- d. Remove the UV Module(s) from the Ventilator.
(Caution: Care must be taken to keep the connector from hitting the lamps while removing the module.)
- e. Using a damp non abrasive cloth and mild detergent, wipe down the Lamps and Lamp Housing. Lamps should be free of all grease and debris.
- f. Carefully inspect the UV Module Access Door and replace the gasket as needed to ensure a good seal.
- g. Reinstall the UV Module(s) being careful to not hit the Lamps.
- h. Reconnect the UV Module Lamp Ballast Connector.
- i. Close the UV Module Access Door(s).

3. Test Safety Interlocks for the XGS Extractors *(Pressure Switches)*

(Caution: For the following tests Polycarbonate Safety Glasses must be worn.)

- a. Turn on the exhaust fan at the Command Center. The “UVi SYSTEM ON” green Status Light in each Ventilator Section should be on.

UV System Scheduled Preventive Maintenance - Cont.

Test Safety Interlocks for the XGS Extractors (*Pressure Switches*) - Cont.

- b. Open the Extractor Access Door at the left end of the Ventilator remove one XGS Extractor. The blue “UVi System Standby” Status Light should come on. If this action does not occur, immediately shut down the exhaust fan at the Command Center. Refer to the Troubleshooting section of this manual for corrective action. Repeat tests 3a and 3b for the right most XGS Extractor and again for the center XGS Extractor.
- c. If there is more than one Ventilator section, repeat tests 3a and 3b for each section.

4. Test Safety Interlocks for the UV Module Access Panel (*Pressure Switches*)

(Caution: For the following tests Polycarbonate Safety Glasses must be worn.)

- a. Turn on the exhaust fan at the Command Center. The “UV System On” green Status Light in each Ventilator Section should be on.
- b. Open one UV Module Access Door (refer to Figure 2-10-2). (**Note:** If there are two UV Module Access Doors always open the shortest door for the test). The blue “UVi System Standby” Status Light should come on. If this action does not occur, immediately shut down the exhaust fan at the Command Center, refer to the Trouble Shooting section beginning on page 4-3 for corrective action.
- c. If there is more than one Ventilator section, repeat the tests above, 4a and 4b, for each section.

5. Lamp Replacement

The UV Lamps need to be replaced after 13,000 hours of use. After 13,000 hours the Lamps will still work but the performance of the Lamps decreases dramatically. The Gaylord Command Center has a built-in UV hours of operation clock. Refer to the Operation and Maintenance Manual for the Gaylord Command Center for complete operational instructions. If the Lamps have been in use over 13,000 hours they should be replaced. Refer to Page 5-7 of this manual for detailed instructions for replacing Lamps.

Opening Extractor Access Door

To open the Extractor Access Doors proceed as follows:

1. Place your hands around the lower edge of the door as shown below. Pull the door out and slightly up until the hinge pin lines up with the vertical slot and the door drops down approximately 1/2".
2. Swing the door out and up as shown below.
3. Slide the door in to hold open.
4. To close the door reverse the procedure.

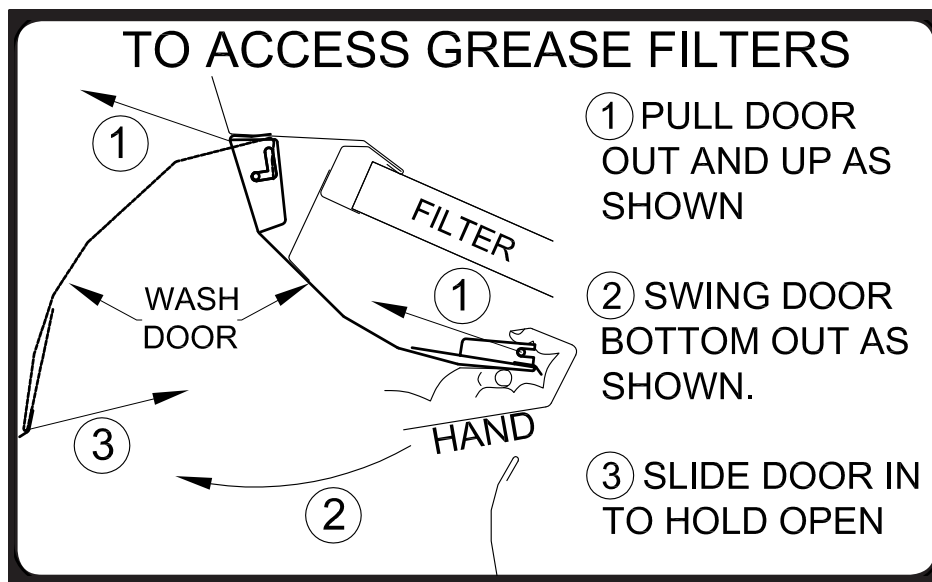

Figure 3-6-1
Opening Extractor Access Doors Label

Troubleshooting

Using the Troubleshooting Charts

The following Troubleshooting Charts are designed to easily find common problems, the probable cause and guidance on corrective action. In some cases the Corrective Action column will reference the Testing and Repair section of this manual for additional guidance and actions.

SMOKE LOSS		
SYMPTOM	PROBABLE CAUSE	CORRECTIVE ACTION
1 The Ventilator is not exhausting all the smoke, heat and grease properly.	A. Exhaust volume is low due to fan performance issues or a Gaylord Balancing Damper, is not adjusted properly. Measure the exhaust volume as described on page 5-1 through 5-4.	1 Check exhaust fan for broken or slipping belts. Adjust or replace belts as required.
		2 Confirm proper rotation of fan wheel.
		3 Check for proper size of exhaust fan. Fan must deliver Ventilator Nameplate rating.
		4 Check and adjust Gaylord Balancing Damper as described pages 2-19 of this manual.
		5 Check for open access panel in duct system and close or re-install if open.
	B. Exhaust volume is low due to a heavy grease accumulation on the Extractors.	1 Remove the Extractors and inspect for grease accumulation. If the extractors are not being washed effectively refer to the Troubleshooting section on WASH CYCLE.
	C. The Ventilator must have its own exhaust system and no other exhaust, such as dishwasher hoods should be tied into it.	1 Inspect the duct system and verify that there are no other non Type I Ventilator systems tied in. If so they must be removed.
	D. Improperly placed make-up air diffusers.	1 Make-up air directed at the Ventilator will likely create cross drafts disrupting the air flow into the Ventilator. Adjust the louvers to direct the make-up air away from the Ventilator. Refer to page 5-5 for guidance.
		2 Make-up air should be delivered through registers at ceiling height, and distributed throughout the kitchen area. Refer to page 5-5 for guidance.
		3 Make-up air registers located near the Ventilator, the louvers should be adjusted to direct the air away from the Ventilator. Directing or forcing the make-up air at the Ventilator typically creates cross drafts resulting in smoke loss. Refer to page 5-5 for guidance.
	E. Inadequate make-up air	1 Make-up air must be supplied for replacement of air exhausted through all kitchen exhaust systems. Refer to page 5-5 for guidance.
		2 A general "rule of thumb" is that 60% of the replacement air should be fresh, conditioned, (heated or cooled) air brought into the kitchen area, with the remaining 40% allowed to flow into the kitchen from adjacent areas. Refer to page 5-11 for guidance.
F. Exhaust fan discharge	1 There should be no screen over the discharge. If one is found, it should be removed.	
	2 The direction of discharge should not be into the prevailing winds nor downward onto the roof. A vertical discharge is highly recommended.	
GREASE EXTRACTION		
SYMPTOM	PROBABLE CAUSE	CORRECTIVE ACTION
1 Poor grease extraction.	A. Ventilators exhausting too much air can cause an excessive amount of noise and allow grease to be pulled through the Extractors. Ventilators exhausting below design will also allow grease to be pulled through the Extractors.	1 Check for proper exhaust volume by following the instructions beginning on page 5-1.
	B. Sticky grease may have accumulated within the Extractors, creating a higher velocity within the Extractors allowing grease to be pulled through.	1 Remove the Extractors and inspect for grease accumulation. If the extractors are not being washed effectively refer to the Troubleshooting section on WASH SYSTEM.

Troubleshooting Charts - Cont.

EXHAUST FAN		
SYMPTOM	PROBABLE CAUSE	CORRECTIVE ACTION
1 If the START FAN button is pushed but the exhaust fan does not come on.	A. Overload protector on the magnetic starter has tripped.	1 Push the "Reset" button on the magnetic starter and push the START FAN button.
	B. If a HOA (Hands Off/Automatic) type magnetic starter switch is used, the selector switch may have been moved from the automatic position.	1 Check the switch and turn the selector to the automatic position.
	C. Exhaust fan circuit breaker tripped.	1 Re-set circuit breaker.
	D. If the system is equipped with a fused disconnect switch for the exhaust fan, a fuse or fuses may have blown out.	1 Check continuity of fuses and replace if necessary.
	E. The Gaylord Command Center may have been improperly wired.	1 Refer to the wiring diagrams beginning on page 7-1.
	F. The Gaylord Command Center is malfunctioning.	1 Refer to the Operation and Maintenance Manual for the Gaylord Command Center, the Troubleshooting section.
2 If the START FAN button is pushed and air is not being pulled through the Ventilator but you can hear there fan running.	A. If the Ventilator is equipped with a manually adjustable balancing damper, the damper may be closed or closed down to far.	1 Check the balancing dampers. For guidance on the proper opening refer to instructions beginning on page 2-19.
	B. If the ventilator is equipped with either a electric balancing damper or a fire/balancing damper, the damper closes each time the STOP FAN button is pushed. The damper may not be re-opening when the START FAN button is pushed.	1 Open the Extractor Access Panel nearest the exhaust duct collar and remove the Extractor. Push START FAN and observe the damper. If the damper does not move to a partially open or fully open position then there is either a mechanical or electrical malfunction. Refer to page 2-19 instructions on corrective action.
	B. Fan drive belt is slipping.	1 Tighten belt and then measure exhaust volume to verify. Refer to instructions on measuring exhaust volume beginning on page 5-1.
	C. Fan is running in reverse.	1 Contact electrical contractor to wire correctly.
WASH SYSTEM		
SYMPTOM	PROBABLE CAUSE	CORRECTIVE ACTION
1 The Wash Cycle is not adequately cleaning the Extractors or Plenum.	A. The water supply is turned off or partially off.	1 Check the hand valves inside the Wash Control Cabinet. Refer to Figure 2-15-1. 2 Check any valves upstream of the Wash Control Cabinet.
	B. Low Water Pressure - Check the water pressure gauge inside the Command Center cabinet. Pressure should be 40 psi min. while the Ventilators are washing.	1 Check the hand valves inside the Wash Control Cabinet to make sure they are fully opened. Refer to Figure 2-15-1. 2 Check any valves upstream of the Wash Control Cabinet to make sure they are fully opened. 3 The Line Strainer inside the Wash Control Cabinet may be clogged. Refer to the Operation, Maintenance and Installation Manual for the Gaylord Command Center and Wash Control Cabinet for instructions on cleaning the Line Strainer.
	C. Low Water Temperature - Check the temperature gauge inside the Wash Control Cabinet. The temperature should be between 140 degrees F. to 180 degrees F.	1 If below temperature it must be increased at the hot water source.
	D. Inadequate Wash Cycle frequency.	1 Refer to page 2-15 for guidance.
	E. Inadequate length of Wash Cycle.	1 Refer to page 2-15 for guidance.
	F. Detergent tank empty.	1 Check and fill the detergent tank at least weekly.
	G. Improper detergent.	1 Refer to page 2-17 for recommended detergent.
	H. Detergent pump has lost it's prime or is malfunctioning.	1 Refer to the Operation, Maintenance and Installation Manual for the Gaylord Command Center and Wash Control Cabinet, the Troubleshooting section.
	I. Clogged Spray Nozzle(s).	1 To determine if there are clogged spray nozzles refer to the instructions on page 5-25.

Troubleshooting Charts - Cont.

WASH SYSTEM - Cont.		
SYMPTOM	PROBABLE CAUSE	CORRECTIVE ACTION
2 Water Sprays, either the Extractor Wash sprays or the Plenum Wash sprays never come on.	A. Malfunction water solenoid valve located on top of the Ventilator.	1 Refer to page 5-23 for trouble shooting and corrective action.
	B. Malfunction PLC control in the Command Center control.	1 Refer to the Operation, Maintenance and Installation Manual for the Gaylord Command Center and Wash Control Cabinet, the Troubleshooting section.
3 Extractor Wash or Plenum Wash is spraying when the Command Center is <u>not</u> in a Wash Cycle.	A. Water Solenoid Valve is stuck in the open position.	1 Gently tap the valve housing with a hammer. This should release foreign material trapped in the valve and the water should stop. If tapping does not release the valve must be disassembled and checked. Refer to Page 5-23 for instructions.

DRAINS		
SYMPTOM	PROBABLE CAUSE	CORRECTIVE ACTION
1 If during a Wash Cycle water overflows the gutter and comes out the inlet slot.	A. Clogged drain outlet. (Note: each Ventilator section has its own drain outlet).	1 The drain outlet is always located at either the right or left end of the Ventilator. Open the Extractor Access Door at both ends of the Ventilator, reach in and down into the bottom of the Grease Gutter until the drain outlet is found. Remove any grease or debris found.
	B. (If more than one Ventilator section in not draining it indicates that the building drain system is clogged).	1 A chemical drain cleaner applied per instructions may dissolve stoppage. Pour cleaner into the Grease Gutter at the drain opening. 2 Hire a drain rooter service to clear the entire drain system.
	C. Clogged or full grease trap.	1 Some cities and counties have codes which require grease traps. If a grease trap is in use, check to ensure that it is not clogged.

UV SYSTEM		
SYMPTOM	PROBABLE CAUSE	CORRECTIVE ACTION
1 After exhaust fan is started and the UV Status lights on the Ventilator section(s) illuminate as follows: 1. Green light is Off . 2. Yellow light is Off . 3. Blue light is On .	A. XGS Extractor is missing.	1 Find and replace missing XGS Extractor.
	B. Extractor Access Door open.	1 Close Access Door.
	C. UV Module Access Panel missing or partially open.	1 Replace or close panel.
	D. Safety Interlock Pressure Switch(s) is out of adjustment.	1 Refer to page 5-17 for instructions on adjusting.
	E. Airflow is too low.	1 Confirm Ventilator is at design exhaust volume. Refer to instructions beginning on page 5-1 for measuring exhaust volume.
	F. The internal temperature of the Ballast Box has exceeded 118° F. and the High Temperature Shutdown Controller has activated.	1 Confirm that the cooling fan has not failed. If failed, refer to page 5-16 for instructions on replacing. 2 Check the removable filter in front of the Ballast Box Ventilation Fan to see that it is not clogged or that air inlet to the fan or the louvers at the air outlet is not blocked by building insulation or any other material. Clean the filter or replace with a new filter and/or remove the material that is blocking the air inlet or outlet. 3 Building insulation has been placed over the top of the Ballast Box. Corrective action: Cut a rectangular opening in the insulation, the size of the Ballast Box, and slide it down around the sides of the box. Tape the insulation down so it will not interfere with the openings. Note: the ELXC-UVi Ventilator has been approved and listed for such application, and must not be covered with insulation impeding the cooling openings going into the Ballast Box. 4 Ballast Box Access Cover Plate gasket is missing or broken down. Remove old gasket and replace. Refer to the Parts section of this manual to order a new gasket. 5 The cooking equipment under the Ventilator is in a "runaway" condition operating to hot. Check with owner to see if cooking equipment is operating properly.

Troubleshooting Charts - Cont.

UV SYSTEM - Cont.		
SYMPTOM	PROBABLE CAUSE	CORRECTIVE ACTION
2 After exhaust fan is started and the UV Status lights on the Ventilator section(s) illuminate as follows: 1. Green light is On . 2. Yellow light is On . 3. Blue light is Off .	A. One or more UV Lamps has failed	1 Refer to page 5-7 for instructions on determining which Lamp has failed and replace.
	B. UV Ballast has failed.	1 Refer to page 5-14 for instructions on determining which Ballast has failed and replacing.
	C. Loose wires.	1 Check wires 1A and 3A from the Command Center to the UV Ballast Box. If either are loose, re-secure and tighten.
3 After exhaust fan is started and the UV Status lights on the Ventilator section(s) illuminate as follows: 1. Green light is Off . 2. Yellow light is On . 3. Blue light is Off .	A. No electrical power to the UV Ballast Box located on the top of each Ventilator section.	1 Take steps necessary to supply power to each UV Ballast Box. Refer to the wiring diagrams in Chapter 7 for voltages. 2 Check the Circuit Breaker.
	B. Lamp / Ballast Connector unplugged.	1 Plug in connector. Refer to page instructions beginning on page 5-7.
	C. Loose wire at the Command Center or UV Ballast Box.	1 Check terminal 1U from UV Ballast Box back to the Command Center.
	D. Green status light miss-wired or failed.	1 Confirm light is getting power and/or replace lamp(s) as necessary.
4 After the exhaust fan is started the UV Status Lights on the Ventilator sections do not illuminate.	A. No power on terminal 6U in the Command Center.	1 Check and replace the 4 amp fuse located in the Command Center. Confirm 6U is not shorted and the reason the fuse is blown. If 6U is shorted at some point, find the pinch or short and repair as needed.
	B. Loose wire.	1 Check for voltage on 5U and 6U. Re-secure any loose connections between the Ventilator an the Command Center.
5 Repeated Ballast / UV Lamp failures.	A. UV Ballast Box located on the top of the Ventilator is too hot.	1 Refer to line 1-F on the previous page for corrective action. 2 Check out removable filter. Shake out and replace.
	B. Cooling fan opening and vents are covered up with insulation.	1 Remove all obstructions from the inlet to the fan, and the exit vents. Access to the top of the Ventilator will be required. Note: the ELXC-UV Ventilator has been tested and listed for such application, and must not be covered with insulation impeding the cooling openings going into the Ballast box.
	C. Ballast Box Access Cover Plate gasket is missing or has broken down.	1 Remove old gasket and replace. Refer to the Parts section of this manual to order a new gasket.
6 Command Center not functioning as intended.	A. Varies.	1 Refer to Operation, Maintenance and Installation Manual for the Gaylord Command Center and Wash Control Cabinet, the Troubleshooting section.

Ventilator Control Matrix

Model ELXC and ELXC-UVi Series Ventilator Control Matrix_{Rev 08}															
Action		Reaction													
		1	2	3	4	5	6	7	8			9	10	11	12
		Exhaust Fan	Supply Fan	Extractor Wash (front)	Plenum Wash (rear)	Gaylord Electric Balancing Damper Model GEBD (optional equipment)	Gaylord Fire Balancing Damper Model GFBD (optional equipment)	UV Lamps	UV Status Lights			Building Fire Alarm	Command Center Display Will Read: Important Note: This column shows the text displayed when either the Extractor Wash or Plenum Wash is on.		
									Green "UV System On"	Yellow "UVi Lamp Failure"	Blue "UVi System Standby"				
1	Start Fan Button is Pushed	ON	ON	Note 1	OFF	OPEN	OPEN	ON	ON	OFF	OFF	OFF	OFF	FAN ON, UV ON, EXTRACTOR WASH ON	
2	Stop Fan Button is Pushed	OFF	OFF	OFF	Note 2	CLOSED	CLOSED	OFF	OFF	OFF	OFF	OFF	OFF	FAN OFF, UV OFF, PLENUM WASH ON	
3	Autostart Sensor Reaches 90 Degrees	ON	ON	Note 1	OFF	OPEN	OPEN	ON	ON	OFF	OFF	OFF	OFF	FAN ON, UV ON	
4	Autostart Sensor Drops Below 90 Degrees	Note 3	Note 3	Note 1	OFF	Note 4	Note 4	Note 3	Note 3	OFF	OFF	OFF	OFF	Note 3	
5	Extractor Wash initiated as Programmed	ON	ON	ON	OFF	OPEN	OPEN	ON	ON	OFF	OFF	OFF	OFF	EXTRACTOR WASH ON	
6	Plenum Wash initiated as Programmed	OFF	OFF	OFF	ON	CLOSED	CLOSED	OFF	OFF	OFF	OFF	OFF	OFF	PLENUM WASH ON	
7	UV Safety Interlock Pressure Switch Activates	ON	ON	Note 1	OFF	OPEN	OPEN	OFF	OFF	OFF	ON	OFF	OFF	FAN ON, UV STANDBY	
8	UV Lamp Fails	ON	ON	Note 1	OFF	OPEN	OPEN	Note 7	ON	ON	OFF	OFF	OFF	FAN ON, UV BULB BAD	
9	Ballast Box High Temperature Shutdown Controller Activates	ON	ON	Note 1	OFF	OPEN	OPEN	OFF	OFF	OFF	ON	OFF	OFF	FAN ON, UV STANDBY	
10	Fire Thermostat Activates (see Note 8)	OFF	OFF	OFF	OFF	N/A	CLOSED	OFF	OFF	OFF	OFF	OFF	ON	FIRE IN HOOD, FAN OFF, NOTIFY FIRE DEPT	
11	Chemical Fire System (if equipped) Discharges	Note 5	OFF	Note 9	OFF	Note 6	CLOSED	OFF	OFF	OFF	OFF	OFF	ON	EXT. FIRE ACTIVE	
12	Low Detergent Switch Activates	See Note 10											OFF	LOW DETERGENT	
13	Wash Cycle Test Button Pushed	See Note 11											OFF	EXTRACTOR WASH ON or PLENUM WASH ON, OFF IN XX SECONDS	

Note 1: The Front Wash may be on when the fan is on. The Front Wash comes on after a timed number of hours the exhaust fan is on. The Front wash only comes on when the exhaust fan is on. It will not come on when the exhaust fan is off. Refer to the Typical Example of Frequency and Length of Wash Chart on page 2-16 for typical frequency and wash times of the wash cycles.

Note 2: The Plenum Wash may come when the exhaust fan is shut off. The Plenum Wash will come on after a timed number of hours the exhaust fan is on, but only when the exhaust fan is off. If the Plenum Wash is scheduled to come on, there is a 45 second delay after the exhaust fan shuts off before the Plenum Wash starts. Refer to the Recommended Wash Frequency and Length of Wash Chart on page xx for typical frequency and wash times of the wash cycles.

Note 3: The exhaust and supply fans and UV Lamps will continue to operate for a 15 minute cool down time and then shut off.

Note 4: The Gaylord Electric Balancing Damper or The Gaylord Fire Balancing Damper will close after the 15 minute cool down time. The Dampers are always open when the exhaust fan is on.

Note 5: Chemical Fire Extinguishing Systems are listed to extinguishing a fire with or without the exhaust fan on. The Gaylord Command Center may be interwired with the Chemical Fire System for the exhaust fan to stay on or go off during a fire system discharge. However, typically the system is wired for the exhaust fan to stay on or come on, if the exhaust fan was off, and the supply fan to go off during a fire system discharge.

Note 6: If the Command Center is wired for the exhaust fan to stay on, the electric balancing damper will stay open. If the Command Center is wired for the exhaust fan to shut off, the electric balancing damper will close.

Note 7: If one or more UV Lamp fails the remaining stay on.

Note 8: The Fire Thermostat is only used when the Ventilator is equipped with a Gaylord Fire Balancing Damper Model GFBD.

Note 9: If the Wash Cycle is on it will automatically shut off.

Note 10: Low detergent notification occurs only when either the Extractor Wash or Plenum Wash is on.

Note 11: If there is more than one Ventilator section, when either the Extractor or Plenum Wash Test button is pushed, all the Ventilator sections Extractor or Plenum Washes would wash in sequence with a 30 second delay between them.



INTENTIONALLY LEFT BLANK

Measuring Airflow

Measuring Airflow

Overview

ELXC and ELXC-UVi Ventilators are factory engineered to operate at a specific exhaust volume, CFM (Cubic Feet per Minute), based on, primarily, the type of cooking appliance, their associated energy input, and the exact model of the Ventilator. Smoke capture, grease extraction efficiency and heat removal are dependent upon the proper exhaust volume (Airflow) through the Ventilator. If the exhaust volume is below design, smoke, grease and heat may escape the confines of the Ventilator creating an uncomfortable kitchen for the operators. It will also reduce grease extraction efficiency of the XGS Extractors resulting in additional grease depositing in the duct system and exhaust fan. This can lead to sanitation problems and fire hazards if left uncorrected. If the exhaust volume is higher than design, more energy will be used to operate the exhaust fan, excessive noise levels may result, and grease can be pulled through the Extractors depositing in the duct and fan. Operating the Ventilator at higher or lower airflows than design will result in the entire kitchen ventilation system being out of balance.

It is important that at initial installation of the Ventilator the exhaust volume is measured to verify that it meets design. It is also recommended that the exhaust volume be measured once every two or three years to insure that the exhaust fan is operating properly. The exhaust volume for each Ventilator section is stamped on the Ventilator Nameplate (refer to Figure 5-4-1 on page 5-4).

Measuring Airflow

The Ventilator exhaust volume is determined by measuring the air inlet velocity and using FPM to CFM Table T-5-4-1 to convert the recorded velocity FPM, to an exhaust volume in CFM Per Lineal Ft. of Ventilator. This method requires an Anemometer and the recommended unit is a Pacer rotating vane Model DA40 or DA4000 Digital Anemometer. These instruments can be purchased from Gaylord Industries. To measure the air inlet velocity and confirm the exhaust volume, proceed as follows:

Instructions

1. For safety purposes turn off the cooking equipment and allow to cool.
2. Confirm that all XGS Extractors are clean and in place.
3. Close all Extractor Access Doors.
4. If model ELXC-UVi Series, make sure all UV Module Access Doors are in closed and latched.
5. Turn on the exhaust fan.
6. Attach the cable from the sensing head to the meter (refer to Figures 5-3-1 and 5-3-2).
7. Attach the handle sections to the sensing head.
8. Beginning at one end of the Ventilator, place the sensing head into the inlet slot with the handle in the horizontal position as shown in Figure 5-3-1.
9. Using the 16 second averaging feature on the meter, slide the sensing head along the entire length of the slot, slowly, at a rate that would last approximately 16 seconds. If you reach the end of the Air Inlet Slot before the 16 second interval has elapsed, continue moving the probe head back the other direction (without removing it) until the 16 second interval has expired.

Measuring Airflow - Cont.

10. At the end of 16 seconds an average velocity will appear on digital readout of the meter.
11. Record the average velocity (FPM).
12. Repeat the process for any additional Ventilator sections.
13. Using Table T-5-4-1, find the nearest Inlet Velocity to the Recorded Velocity and read across to the Related CFM Per Lineal Ft. column. This is called the Determined CFM Per Lin. Ft.
14. As an alternate to step #13, multiply the Recorded Velocity by 0.217. The result is the Determined CFM Per Lin. Ft.
15. Measure the length of the Ventilator, in feet, and multiply by the Determined CFM Per Lin. Ft. The result is the Total Exhaust Volume for the Ventilator.
16. Compare this Total Exhaust with the "Min. Suggested Total Exhaust Volume For This Section" stamped on the Ventilator Nameplate and proceed to step 17 (Refer to Figure 5-4-1).
17. The acceptable range is 0% low to 10% high. If the CFM is not within acceptable range then corrective action must be taken to bring the exhaust volume within design.
18. If the Ventilator does not include a Balancing Damper, the exhaust volume must be increased or decreased by adjusting the exhaust fan. If the exhaust fan is not operating properly, refer to the Troubleshooting section of this manual for possible problems and corrective action.
19. If the Ventilator has a balancing damper, and if the Determined CFM is low, the Balancing Damper needs to be opened slightly. If the Determined CFM is high the Balancing Damper needs to be closed slightly. Place the Sensing Head at the Air Inlet Slot and continue either opening or closing the Balancing Damper until the velocity reading on the meter is at or close to the desired Inlet Slot FPM number on Table T-5-4-1. Refer to page 2-19 for specific instructions on adjusting the dampers.

Important Note: Keep in mind that as one damper is adjusted it will affect the exhaust volume in the remaining Ventilator sections so making minor adjustments, and coming back and retaking Air Inlet Velocity readings is highly recommended.

Measuring Airflow - Cont.



Figure 5-3-1
Sensing Head at Air Inlet Slot





Figure 5-3-2
Anemometer

Measuring Airflow - Cont.

Table T-5-4-1

FPM to CFM Table			
Inlet Slot FPM	Related CFM Per Lin Ft.	Inlet Slot FPM	Related CFM Per Lin Ft.
479	104	880	191
507	110	912	198
571	124	931	202
585	127	945	205
604	131	972	211
631	137	1005	218
664	144	1037	225
677	147	1065	231
724	157	1129	245
788	171	1147	249
821	178	1175	255
848	184	1290	280



EXHAUST HOOD WITH OR WITHOUT EXHAUST DAMPERS

THIS EXHAUST HOOD HAS BEEN TESTED TO STANDARD UL 710 "EXHAUST HOODS FOR COMMERCIAL COOKING EQUIPMENT, AND WHERE APPLICABLE TO UL 710C "ULTRAVIOLET LAMPS USED FOR REDUCTION OF GREASE LADEN VAPOR FROM COOKING EQUIPMENT".

THIS HOOD IS LISTED UNDER INTERTEK, ETL SEMKO REPORT NUMBER 3192993CRT-002, AND G100390446CRT-002 FOR ELXC MODELS CONTAINING INTERNAL WASH DOWN SYSTEMS.

ELXC MODEL HOOD FOR USE WITH LISTED SUB-ASSEMBLY CONTROL AND WASH DOWN CABINET MODEL GPC-7000.

THIS EXHAUST HOOD MEETS ALL REQUIREMENTS OF THE LATEST EDITION OF NFPA-96 AND THE IMC (INTERNATIONAL MECHANICAL CODE).

GAYLORD INDUSTRIES
 10900 S.W. AVERY STREET
 TUALATIN, OR 97062 USA
 (800) 547-9696
 EMAIL: info@gaylordusa.com
 www.gaylordusa.com
 PATENT PENDING

ELX0611 / 20137

ENGINEERING DATA

MODEL NO.	
SERIAL NO.	
1. MIN SUGGESTED TOTAL EXHAUST VOLUME FOR THIS SECTION	C.F.M.
2. EXHAUST STATIC PRESSURE AT HOOD DUCT COLLAR	W.G.

MAXIMUM COOKING SURFACE TEMPERATURE	400°F	600°F	700°F
CANOPY HT.	LISTED MIN VALUES IN CFM/LF OF HOOD		
	FACETED, CHAMFERED, OR ROUND FRONT SQUARE FRONT WITH 6 TO 12 INCH SUPER CAP LIP		
HP-30 INCH MIN W/ REAR WALL	104	124	157
HP-30 INCH MIN NO REAR WALL	110	137	171
MP-24 INCH MIN W/ REAR WALL	131	171	218
MP-24 INCH MIN NO REAR WALL	137	178	218
LP-12 INCH MIN W/ REAR WALL	147	191	231
LP-12 INCH MIN NO REAR WALL	151	191	231
BB-24/30 INCH MIN. ISLAND	170	205	249
BB-12 INCH MIN (DOUBLE, VALUE/SIDE)	170	205	249
BB-30 INCH MIN (DOUBLE, VALUE/SIDE)	170	231	255
	170	231	255
	127	171	211
	127	171	211
	127	171	211
	127	171	211

1. REFER TO GAYLORD VENTILATOR TECHNICAL MANUAL FOR METHOD(S) OF VERIFYING AIR VOLUMES.
2. ELECTRICAL RATING OF LIGHT FIXTURES: 120 VOLT, 60HZ. OR 220 VOLT 50HZ OVERALL RATING - 12 AMPS OR LESS
3. IF HOOD IS EQUIPPED WITH ULTRAVIOLET LAMP SYSTEM, CONSULT GAYLORD VENTILATOR TECHNICAL MANUAL FOR PROPER MAINTENANCE AND SAFETY PRECAUTIONS.
4. FRONT OVERHANGS ARE 12"FRONT / 6"SIDE UNLESS OTHERWISE NOTED. BBC MODEL HOODS ARE 12"FRONT / 7.5"SIDE. (SEE LOCATION BELOW)

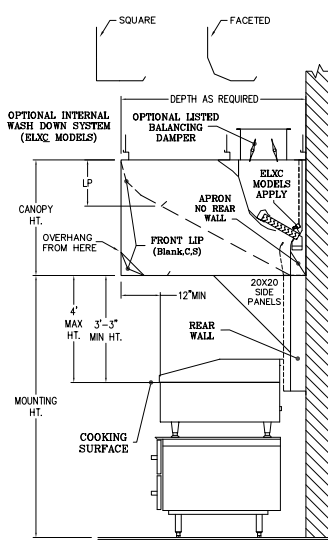

SECTION VIEW

Figure 5-4-1 Ventilator Nameplate

Measuring Airflow - Cont.

Capture Performance

All Gaylord Ventilators are factory engineered to operate at a specific exhaust volume, CFM (Cubic Feet per Minute), based on, primarily, the type of cooking appliance, and the exact model of the Ventilator. Capture performance is based on two primary functions, 1) the ventilator is exhausting the engineered CFM and 2) the make-up air is being introduced correctly. Make-up air introduced incorrectly will typically result in smoke and heat loss into the kitchen, even if the Ventilator is operating at the engineered CFM. Make-up air is typically brought into the kitchen space through ceiling diffusers or through a combination of Gaylord Make-Up Air Plenum Boxes, Model PBW, (refer to Figure 5-6-1) and ceiling diffusers.

Capture and Performance Guarantee

Gaylord Industries provides the following guarantee for all Gaylord Ventilators:

Gaylord Capture Performance Guarantee

Gaylord Industries warrants the Capture Performance of the Ventilator, only if the Exhaust Air Volumes are correct, per the Exhaust Volume Guidelines as stated below, and the Make-up Air Volumes are correct and delivered correctly per the Make-up Air Delivery Guidelines as stated below.

Exhaust Volume Guidelines

1. The amount of exhaust CFM through the Ventilator shall be between 100% and 110% of the values stamped on the Ventilator Nameplate for each Ventilator section.

Make-up Air Delivery Guidelines

A. With Gaylord Plenum Boxes and ceiling diffusers.

1. Gaylord Plenum Boxes Model PBW, shall be located immediately in front of the Ventilator, a minimum of 18" from the lower lip of the Ventilator to the discharge surface of the Plenum Box. (Refer to Figures 5-6-1 and 5-6-2).
2. The amount of make-up air delivered through the Gaylord Plenum Box(s) shall be between 90% and 100% of the values shown on Gaylord Submittal Drawings.
3. The amount of make-up air through the Plenum Boxes shall not exceed 60% of the exhaust volume of the Ventilator.
4. Ceiling diffusers shall be at least 6'-0" away from all sides of the Ventilator and the outlet velocity at the diffusers shall not exceed 150 Feet per Minute (FPM).

B. With ceiling diffusers only.

1. Ceiling diffusers shall be at least 15'-0" away from all sides of the Ventilator and the outlet velocity at the diffusers shall not exceed 300 Feet per Minute (FPM) (Refer to Figure 5-6-1).

C. Additional Requirements.

1. The maximum velocity of the make-up air from diffusers, transfer air diffusers, or any other type of diffusers shall not be greater than 75 FPM on all open sides of the lower edge of the Ventilator.
2. Cross drafts from pass through windows, hallways, or other openings shall not exceed 50 FPM.
3. All forms of make-up air, such as ceiling diffusers, transfer air diffusers, and Plenum Boxes must be evenly distributed around each Ventilator to prevent unequal pressurization.
4. Kitchen pressurization shall not exceed -0.02" W.G. relative to the dining or adjacent spaces as stated in NFPA-96 and ASHRAE Standard 154.
5. For more information on acceptable methods of make-up air delivery reference ASHRAE Standard 154.

Make- Up Air Guidelines

Following these guidelines will result in proper capture and containment at the Ventilator and enact the Gaylord Capture Performance Guarantee. If jobsite conditions cannot accommodate these guidelines, consult Gaylord Industries for alternative design.

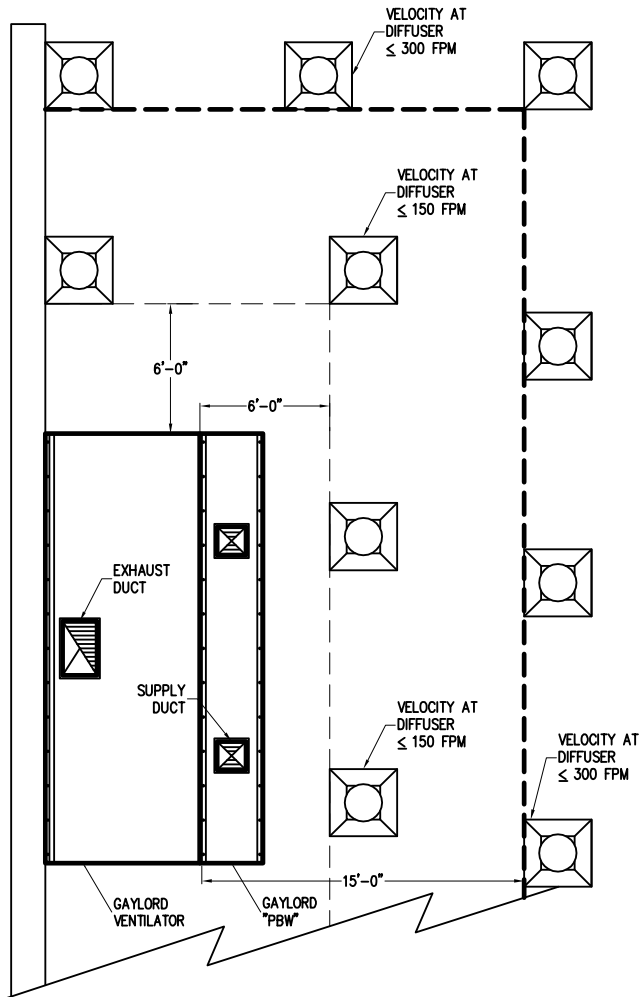

Figure 5-6-1
Plan View - Typical Kitchen

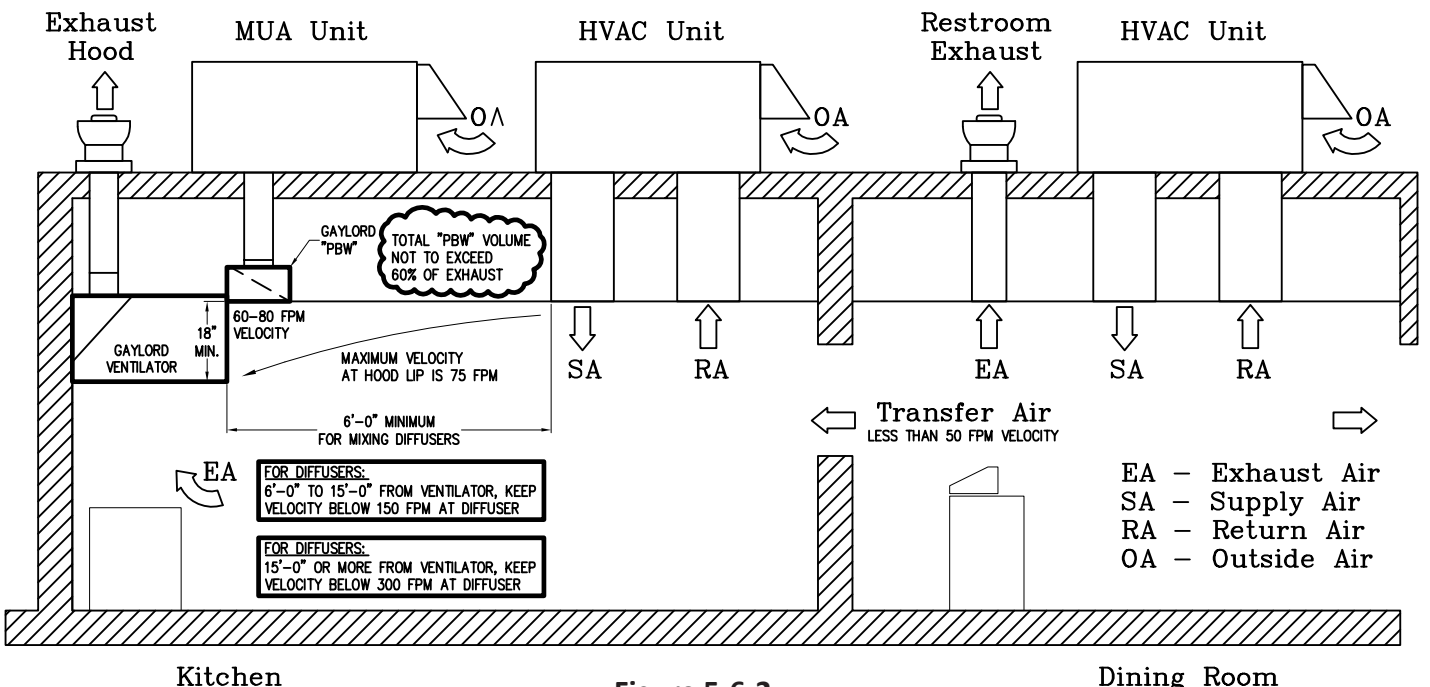

Figure 5-6-2
Section View - Typical Kitchen

Replacing UV Lamps

Overview

The UV Lamp Modules come in two lengths, a nominal 3'-0" and 5'-0". The length and number of modules is dependent on the length of the Ventilator section (refer to Table T-5-7-1). There are six lamps in each module.

Table T-5-7-1

Number of UV Lamp Modules		
Active Ventilator Length	Number of 3'-0" Modules	Number of 5'-0" Modules
4'-0" – 6'-5"	1	0
6'-6" – 7'-5"	0	1
7'-6" – 9'-11"	2	0
10'-0" – 12'-5"	1	1
12'-6" – 16'-0"	0	2

Replacing UV Lamps

DANGER: Replacing UV Lamps as outlined on this page **MUST** be performed by a Gaylord Certified Service Agent. For a list of Gaylord Certified Service Agencies (CSA's) visit www.gaylordventilation.com and go to "Service Agencies".

SAFETY PRECAUTIONS

Tasks involved to replace UV Lamps involve potential exposure to high doses of UV light and live electrical components. There is a risk of serious injury to skin and eyes from UV light. There is a risk of shock, injury, and /or death from live electrical components.

Personal Protective Equipment

1. Eye protection that prevents 100% of UV light being transmitted through the lens must be worn at all times when replacing the UV Lamps on any ELXC-UVi Ventilator that is energized and/or has the potential to be energized and expose personnel to UV light.
2. Whenever service work is performed it is recommended that long sleeve shirts and pants be worn to minimize the potential for inadvertent exposure of the skin to UV light.

Replacing UV Lamps - Cont.

Instructions for Replacing UV Lamps

To replace UV lamps carefully use the following step by step instructions.

1. Turn off all power to the Gaylord Command Center.
2. Turn off all circuits that supply power to the UV Lamps.
3. Open the UV Module Access Door (Refer to Figure 5-9-1).
4. Disconnect the Lamp / Ballast Connector cable by twisting the connector counter clockwise (refer to Figure 5-13-1).
5. Carefully slide out the UV Module (refer to Figure 5-9-1).
6. Referring to Figure 5-9-2, remove the two bolts pc #9, washer's pc #8, Module End Cap pc #7, and Silicon Gasket pc #6 from each end of the module.
7. Slide off each UV Lamp Sockets, pc #5, from the Lamps at each end of the Module.
 - Each UV Lamp Socket should be labeled 1 to 6.
 - Lamp #1 is at the front of the Ventilator when the UV Module is installed.
 - Lamp #6 is at the back of the Ventilator when the UV Module is installed.
 - Be sure to re-label the Lamp Sockets if necessary.
8. Lubricate the Lamps around the Grommets, pc # 2, on each end of the UV Lamp with a small amount of Formula G-510EF or similar detergent.
9. CAREFULLY slide the UV Lamp out one end.
10. Inspect the Grommets around the Lamps.
 - Replace any Grommet that show cracks, or any other damage.
11. Check all UV Lamp Sockets and wires for damage.
 - Replace Light Sockets if the socket or wire show damage.
12. Before installing, lubricate each of the new UV Lamps with a small amount of Formula G-510EF or similar detergent.
13. Slide in all the new UV Lamps.
14. Reconnect all the UV Lamp Sockets to the appropriate numbered Lamp, #1 through #6.
15. Check the Silicon Gaskets for cracks or deterioration. Replace if needed.
16. Re-install the Silicon Gaskets, Module End Caps, Washers and bolts, and torque the bolts to 20 in – lbs.
17. Slide the UV Module back into the Ventilator.
18. Reconnect the Lamp / Ballast Connector Cable.
19. Check the UV Module Access Door Gasket for cracks or deterioration. Replace if needed.
20. Close the UV Module Access Door.
21. Close all Extractor Access Doors.
22. Turn on all circuits that supply power to the UV Lamps.
23. Turn on power to the Gaylord Command Center.
24. Check for proper operation of the UV Lamps and Pressure Switches following the Test Lamps and Ballasts instructions on page 3-3.

Replacing UV Lamps - Cont.

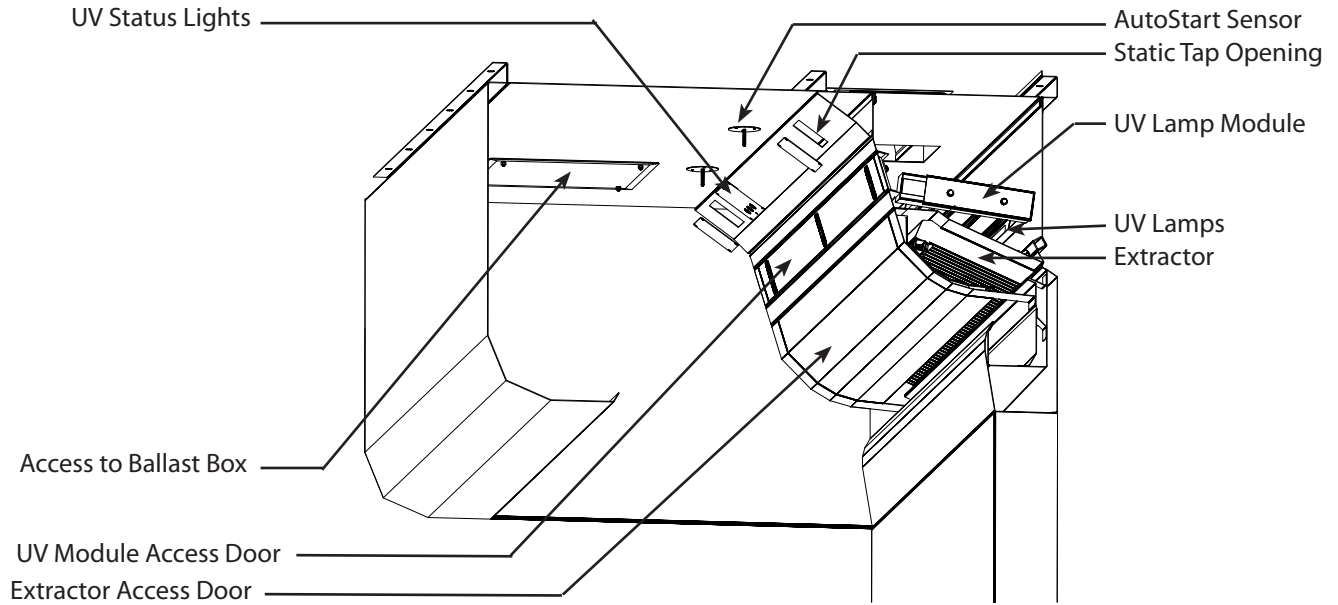

Figure 5-9-1

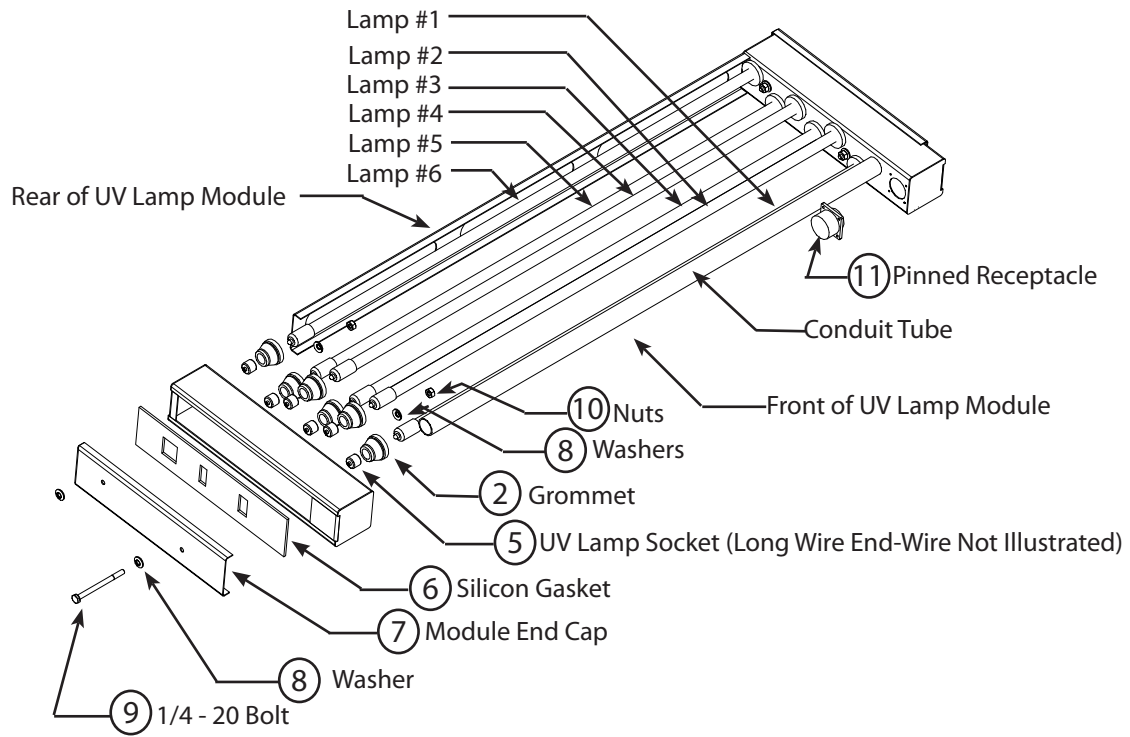

Figure 5-9-2
UV Module
(Exploded View)

Replacing UV Lamp Sockets

Overview

If the UV Lamp Socket or wire connected to it is damaged they must be replaced. The UV Lamp Socket and the wire come as one piece. They are not available individually. There are two methods of replacing UV Lamp Sockets, the Individual Method or the Wiring Harness Method. Use the following directions for replacing:

DANGER: Replacing UV Lamp Sockets as outlined on the following pages MUST be performed by a Gaylord Certified Service Agent. For a list of Gaylord Certified Service Agencies (CSA's) visit www.gaylordventilation.com and go to "Service Agencies" or call Gaylord Industries at 503-691-2010.

Safety Precautions

Caution: Tasks involved in replacing UV Lamp Sockets involve potential exposure to high doses of UV light and live electrical components. There is a risk of serious injury to skin and eyes from UV light. There is a risk of shock, injury, and /or death from contact with live electrical components.

Personal Protective Equipment

1. Eye protection that prevents 100% of UV light being transmitted through the lens must be worn at all times when working on UV Lamp Modules on any ELXC-UV Ventilator that is energized and/or has the potential to be energized and expose personnel to UV light.
2. Whenever service work is performed it is recommended that long sleeve shirts and pants be worn to minimize the potential for inadvertent exposure of the skin to UV light.

Instructions for Replacing UV Lamp Sockets – Individual Method

To replace UV Lamp Sockets carefully use the following step by step instructions.

1. Turn off all power to the Gaylord Command Center.
2. Turn off all circuits that supply power to the UV Lamps.
3. Open the UV Module Access Door (Refer to Figure 5-9-1).
4. Disconnect the Lamp / Ballast Connector Cable by twisting the connector counter clockwise (refer to Figure 5-13-1).
5. Carefully slide out the UV Module and place on a work bench.
6. Referring to Figure 5-13-3, remove the two bolts pc #9, washers, pc #8, Module End Cap pc #7, and the Silicon Gasket, pc #6, from each end of the module.
7. Slide off each UV Lamp Socket, pc #5, from the Lamps at each end of the Module.
8. Remove the four screws that hold the base of the Pinned Receptacle, Figure 5-13-3 pc #11, to the Lamp Module and pull the base away from the Module until the wires are exposed.
9. The UV Lamp Sockets are numbered 1 through 6. The wire from each UV Lamp Socket is wired back to the Pinned Receptacle and connected to a pin labeled A through N (refer to Figure 5-11-1). There are two UV Lamp Sockets with wire per Lamp. One is called the UV Lamp Socket Long Wire, the one that runs to the opposite end of the Pinned Receptacle. The other is called the UV Lamp Socket Short Wire, the one that is at the end with the Pinned Receptacle. Identify the wire by number to be replaced.
10. Cut the identified wire at the Pinned Receptacle. CAUTION: Do not pull the UV Lamp Long Wire out at this time. It is needed to pull the new Lamp Socket through the conduit tube.

Replacing UV Lamp Sockets - Cont.

Instructions for Replacing UV Lamp Sockets – Individual Method – Cont.

11. Slide off the UL Lamp Sockets from the Lamp and remove the UV Lamp Socket Short Wire. CAUTION: Do not pull the UV Lamp Long Wire at this time. It is needed to pull the new Lamp Socket through the conduit.
12. Using a Pin Removal Tool, Gaylord Part Number [20415](#), push the associated pin out of the base of the Pined Receptacle.
13. All Lamp Sockets come with a 76" wire length so each has to be cut to match the one being replaced.
14. Cut the correct length wire, and at the end opposite the Lamp Socket, strip back 1/4" of the insulation. Solder on the pin that is provided.
15. Push the soldered wire pin into the base of the Pined Socket, for both the Short and Long Wire, at the appropriate letter socket. Refer to Table T-5-11-1 and Figure 5-11-1.
16. Re-install the Pined Socket base.
17. Replace the UV Socket Long Wire by tying the end of the cut Long Wire to the socket end of the new UV Socket Long Wire and pull it through the conduit wire way (Refer to Figure 5-13-3).
18. Slide the UV Sockets onto the Lamp at both ends.
19. Check the Silicon Gaskets for cracks or deterioration. Replace if needed.
20. Re-install the Silicon Gaskets, Module End Caps, Washers and bolts, and torque the bolts to 20 in – lbs.
21. Slide the UV Module back into the Ventilator.
22. Reconnect the Lamp / Ballast Connector Cable.
23. Check the UV Module Access Door Gasket for cracks or deterioration. Replace if needed.
24. Close the UV Module Access Door.
25. Turn on all circuits that supply power to the UV Lamps.
26. Turn on power to the Gaylord Command Center.
27. Check for proper operation of the UV Lamps and Pressure Switches following the Test Lamps and Ballasts instructions on page 3-3.

Connection Points From Pinned Receptacle to UV Lamp Sockets														
Pin Letter	A	B	C	D	E	F	G	H	I	J	K	L	M	N
Left End Long Wire Lamp Socket #							4	3	2	1	5	Not Used	Ground Wire	6
Right End Short Wire Lamp Socket #	1	2	3	4	5	6								

Table T-5-11-1

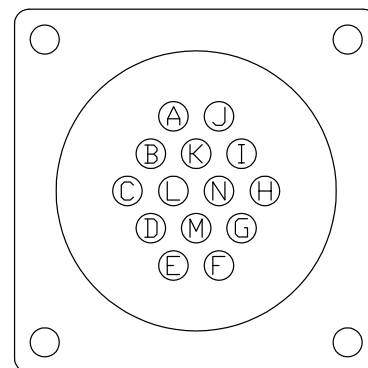

Figure 5-11-1
Pinned Receptacle

Replacing UV Lamp Sockets - Cont.

Instructions for Replacing UV Lamp Sockets – Wiring Harness Method

DANGER: Replacing UV Lamp Sockets as outlined on this page **MUST** be performed by a Gaylord Certified Service Agent. For a list of Gaylord Certified Service Agencies (CSA's) visit www.gaylordventilation.com and go to "Service Agencies" or call Gaylord Industries at 503-691-2010.

Safety Precautions

Caution: Tasks involved in replacing UV Lamp Sockets involve potential exposure to high doses of UV light and live electrical components. There is a risk of serious injury to skin and eyes from UV light. There is a risk of shock, injury, and /or death from contact with live electrical components.

Personal Protective Equipment

1. Eye protection that prevents 100% of UV light being transmitted through the lens must be worn at all times when replacing the UV Lamps on any ELX-UVi Ventilator that is energized and/or has the potential to be energized and expose personnel to UV light.
2. Whenever service work is performed it is recommended that long sleeve shirts and pants be worn to minimize the potential for inadvertent exposure of the skin to UVC light.

Overview

The UV Lamp Sockets Wiring Harness comes with 6 Lamp Sockets Long Wire and 6 Lamp Sockets Short Wire connected to the base of a Pinned Receptacle.

Instructions

To replace all UV Lamp Sockets with a wiring harness carefully use the following step by step instructions.

1. Turn off all power to the Gaylord Command Center.
2. Turn off all circuits that supply power to the UV Lamps.
3. Open the UV Module Access Door.
4. Disconnect the Lamp / Ballast Connector Cable by twisting the connector counter clockwise (refer to Figure 5-13-1).
5. Carefully slide out the UV Module and place on a work bench.
6. Referring to Figure 5-13-3, Remove the two bolts pc #9, washers, pc #8, Module End Cap pc #7, and the Silicon Gasket, pc #6, from each end of the module.
7. Slide off each UV Light Socket, pc #5, from the Lamps at each end of the Module.
8. Remove the four screws that hold the base of the Pinned Receptacle, pc #11, to the Lamp Module and pull the base away from the Module until the wires are exposed.
9. The UV Lamp Sockets are numbered 1 through 6. The wire from each UV Lamp Socket is wired back to the Pinned Receptacle and connected to a pin labeled A through N (refer to Figure 5-13-2). There are two UV Lamp Sockets with wire per Lamp. One is called the UV Lamp Socket Long Wire, the one that runs to the opposite end of the Pinned Receptacle. The other is called the UV Lamp Socket Short Wire, the one that is at the end with the Pinned Receptacle. Cut all the wires at the Pinned Receptacle. **CAUTION:** Do not pull the UV Lamp Long Wire at this time. It is needed to pull the new Lamp Socket Long Wire through the conduit tube.

Replacing UV Lamp Sockets - Cont.

10. Remove all the UV Lamp Socket Short Wire. CAUTION: Do not pull the UV Lamp Long Wire at this time. It is needed to pull the new Lamp Socket through the conduit.
11. Pull all but one of the UV Lamp Socket Long Wire.
12. Install the new Pinned Socket base.
13. Replace the group of UV Socket Long Wires by tying the end of the one remaining Long Wire to the socket ends of the new group of UV Socket Long Wires and pull them through the conduit tube.
14. Slide all the UV Sockets onto the Lamp pins at both ends being careful to match the number on the UV Sockets to the number on the Module.
15. Check the Module End Caps Silicon Gaskets for cracks or deterioration. Replace if needed.
16. Re-install the Module End Caps with gasket, washers and bolts, and torque the bolts to 20 in – lbs.
17. Slide the UV Module back into the Ventilator.
18. Reconnect the Lamp / Ballast Connector Cable.
19. Check the UV Module Access Door Gasket for cracks or deterioration. Replace if needed.
20. Close the UV Module Access Door.
21. Turn on all circuits that supply power to the UV Lamps.
22. Turn on power to the Gaylord Command Center.
23. Check for proper operation of the UV Lamps and Pressure Switches following the Test Lamps and Ballasts instructions on page 3-3.



Figure 5-13-1
Lamp / Ballast Connector

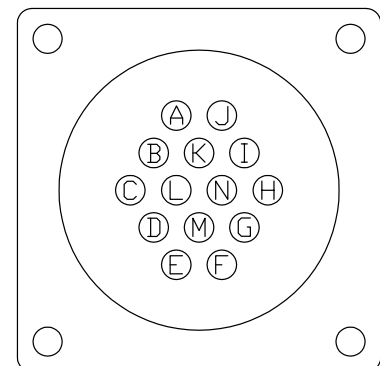

Figure 5-13-2
Pinned Receptacle

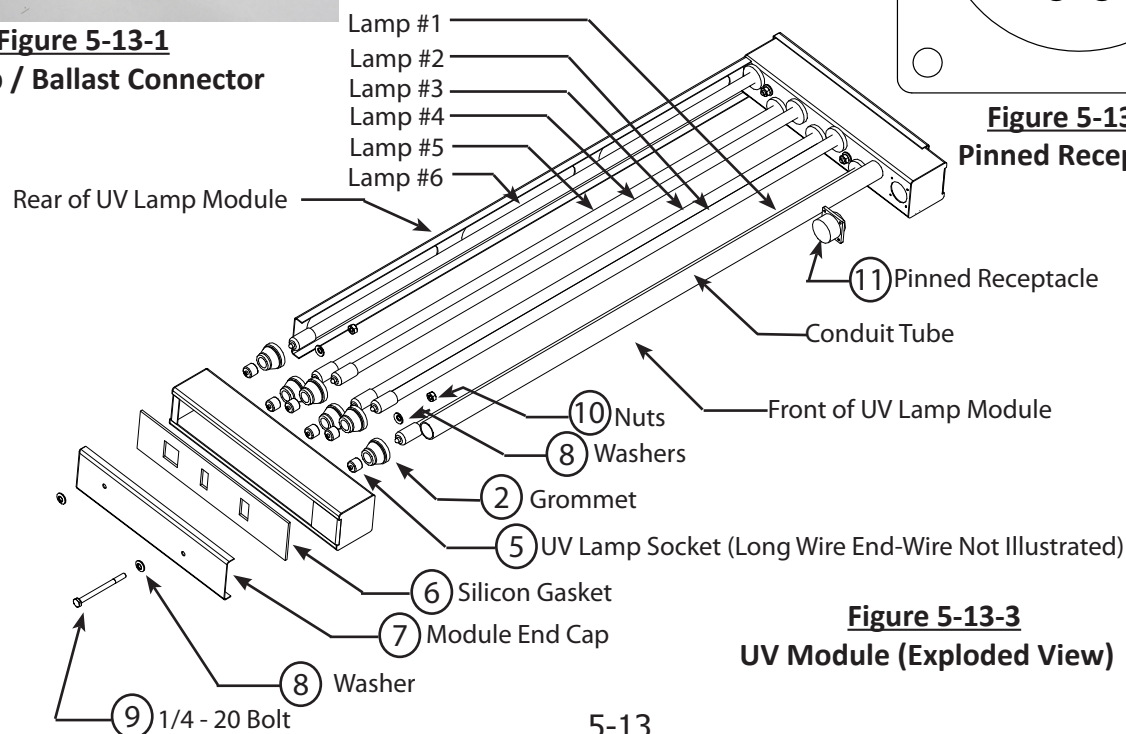

Figure 5-13-3
UV Module (Exploded View)

UV Ballast Box

Overview

There is one UV Ballast Box for each Ventilator section. The UV Ballast Box contains the Ballasts and other electrical components necessary to operate the UV System (Refer to Figure 5-20-2). A list of all the components and their part numbers are shown on Page 6-7 and 6-8. To replace any of the components proceed as follows:

Ballast

The Ballasts are called Ballast Boards (refer to Figures 5-20-2 and 5-22-1). The number of Ballasts Boards is dependent upon the number of UV Lamp Modules, one or two. One Ballast Board serves two UV Lamps. So, for example, if the Ventilator has two UV Lamp Modules then there would be a total of 12 Lamps and therefore six Ballasts Boards. The Ballasts Boards are mounted on Ballast Board Plates (Refer to Figure 5-20-2). If the Ventilator has two UV Lamp Modules there are two Ballast Board Plates, one mounted in front of the other. The Front Ballast Board Plate always serves the left UV Lamp Module and the Rear Ballast Board always serves the right UV Lamp Module. So, for example if the Ventilator has two Lamp Modules the Front Ballast Board Plate would have two Ballast Boards and the Rear Ballast Board Plate would also have two Ballast Boards.

The Ballast Boards are numbered 1, 2 and 3. Ballast Board number 1 serves Lamp number 1 and 2, Ballast Board number 2 serves Lamp number 3 and 4, and ballast Board number 3 serves Lamp number 5 and 6. (Refer to Table T-5-14-1).

Table T-5-14-1

Ballast Board / Lamp Chart			
Left UV Module Front Ballast Board Plate		Right UV Module Rear Ballast Board Plate	
Serves Ballast Board #	Serves Lamp #	Serves Ballast Board #	Serves Lamp #
1	1	1	1
	2		2
2	3	2	3
	4		4
3	5	3	5
	6		6

There are two Green and two Red Status Lights on a Ballast Board, one set for each Lamp (refer to Figure 5-20-2). The Status Lights are numbered Lamp 1 through 6 to correspond with the Lamp number. A Green light indicates the Lamp is operational and a Red light indicates the Lamp is not operational and must be replaced. If both lights are out then the Ballast Board is faulty and it must be replaced.

UV Ballast Box - Cont.

Replacing Ballast Boards

To replace the Ballast Board proceed as follows (refer to Figure 5-20-2 and 5-22-1):

Caution: Turn off all power to the Command Center and to the UV Ballast Box. There is a risk of shock, injury, and /or death from contact with live electrical components.

1. Turn off all power to the Gaylord Command Center.
2. Turn off all circuits that supply power to the UV Lamps.
3. Remove the UV Ballast Box Access Cover.
4. Unplug the Ballast Board power.
5. Remove the two screws that hold the Front Ballast Board Plate. Remove the Rear Ballast Board Plate if necessary.
6. Remove all wires from the terminal blocks. Label if necessary.
7. In three corners of the Ballast Board are plastic standoff retainers and the fourth corner is a screw. Using a screwdriver push in the retainer tab on the plastic standoff while pulling up on the Ballast Board. Remove the one screw.
8. Install a new Ballast Board, wire the plug in harness to the terminal block, mount the Ballast Board to the Ballast Board Plate and remount, and plug the harness back in.
9. Inspect the UV Ballast Box Access Cover Gasket for cracks and deterioration and replace if necessary.
10. Replace the Access Cover.
11. Turn on all circuits that supply power to the UV Lamps.
12. Turn on power to the Gaylord Command Center.
13. Check to make sure both Green lights are on.

Replacing UV Ventilation Control Board

The UV Ventilation Control Board (Refer to Figures 5-19-2 and 5-22-2) monitors all the Safety Interlock Pressure Switches. If the Safety Interlock Pressure Switches are in a normal operational condition, a signal is sent to activate the Ballast Contactor allowing the UV System to operate. If a Safety Interlock Pressure Switch detects a problem, such as an Extractor Access Door or UV Module Access Panel being left open, a signal is sent to deactivate the Ballast Contactor which turns off the UV System. The UV Ventilation Control Board has three main components, the UV Monitoring Board, the Ballast Contactor and the Status Light Relay. If it is determined that any of these three components are defective replace as follows:

Caution: Turn off all power to the Command Center and to the UV Ballast Box. There is a risk of shock, injury, and /or death from live electrical components.

1. Turn off all power to the Gaylord Command Center.
2. Turn off all circuits that supply power to the UV Lamps.
3. Remove the UV Ballast Box Access Cover.
4. Uncouple the wire plug that interties the UV Ventilation Control Board to the Ballast Boards.
5. Unplug the wires leading to the Pressure Switches.
6. Remove all wires from the appropriate terminal blocks. Label if necessary.

UV Ballast Box - Cont.

Replacing UV Ventilation Control Board – Cont.

7. Remove the 2 screws that hold the Din Rail and remove the entire assembly.
8. Loosen and slide off the end retainer (Refer to Figure 5-19-2).
9. Slide off the components as required.
10. Slide on the new component and tighten the end retainer.
11. Reinstall the Din Rail and reconnect all the wires.
12. Inspect the UV Ballast Box Access Box Access Cover Gasket for cracks and deterioration and replace if necessary.
13. Replace the Access Cover.
14. Turn on all circuits that supply power to the UV Lamps.
15. Turn on power to the Gaylord Command Center.

Replacing Ventilation Fan

The Ventilation Fan removes the heat generated by all the electrical components. It is on, typically, whenever the exhaust fan is on. If the Ventilation Fan is not pushing enough air, pull out the mesh filter, clean and replace. If the Ventilation Fan is determined to be defective, replace it as follows (Refer to Figure 5-20-2).

Caution: Turn off all power to the Command Center and to the UV Ballast Box. There is a risk of shock, injury, and /or death from live electrical components.

1. Turn off all power to the Gaylord Command Center.
2. Turn off all circuits that supply power to the UV Lamps.
3. Remove the UV Ballast Box Access Cover.
4. Disconnect the wires from the terminal block.
5. Remove the 4 screws from the holding bracket and remove the fan.
6. Install a new fan in the reverse order.
7. Inspect the UV Ballast Box Access Box Access Cover Gasket for cracks and deterioration and replace if necessary.
8. Replace Access Cover.
9. Turn on all circuits that supply power to the UV Lamps.
10. Turn on power to the Gaylord Command Center

Pressure Switches

There are two Pressure Switches used as the Safety Interlocks that monitor if all the XGS Extractors are in place, and if the UV Module Access Panels are closed and latched. If one or more XGS Extractors are missing and / or one or more UV Module Access Panels are not in place the Pressure Switches will sense a pressure drop and shut down the UV System.

A 1/8" copper tube runs from a Static Pressure Tap in the Ventilator plenum into the Ballast Box. The copper tube is then connected to a clear vinyl tube which in turn is connected to the Pressure Switch. The vinyl tube is called a Vacuum Release Tube and has a small hole mid way in the tube to allow trapped pressure that may

UV Ballast Box - Cont.

Pressure Switches - Cont.

have been caused by the static tap plugging with grease, to bleed off. This safety feature will automatically shut off the UV System if the static tap becomes plugged. **Caution: If the vinyl tube needs replacing always use Gaylord Industries Vacuum Release Tube. Refer to the Parts on Page 6-8.**

The Pressure Switches must be set prior to the initial operation of the Ventilator, and after the exhaust volume has been verified in accordance with the Measuring Airflow section on pages 5-1 through 5-5. To set the Pressure Switches proceed as follows (Refer to Figure 5-19-1):

Caution: Testing the Pressure Switches must be performed by Gaylord Certified Service Agent. For a list of Gaylord Certified Service Agencies (CSA's) visit www.gaylordventilation.com and go to "Service Agencies".

Caution: The Pressure Switches are located in the Ballast Box which is only assessable from the underside of the Ventilator. Therefore before you get started setting the Pressure Switches be sure to provide yourself secure means to the equipment in order to gain access to the critical components contained in the ELXC Ballast Box.

Caution: To set the Pressure Switches the exhaust fan must be on and therefore the Ballast Box will have live electrical components. Be extremely careful not to make contact with live electrical components. It is recommended that gloves be worn while adjusting the switches. There is a risk of shock, injury, and / or death from contact with live electrical components.

CAUTION: Verify that the SPADE CONNECTORS ARE IN PLACE PRIOR TO ANY ADJUSTING as illustrated in Figure 5-19-1. If Not proceed to "Spade Connector not in Place Procedure".

PRIOR to Starting (Site Conditions): The Kitchen Exhaust system is to be fully balanced. All Doors and windows to be closed and sealed consistent with the future operation of the kitchen. Make up air and transfer air systems are to be activated and running during this procedure. Cooking Equipment is to be OFF. Kitchen Ambient Temperatures are to be between 75°F and 85°F. Kitchens running outside these temperatures may not be set correctly. A follow up must be conducted with the kitchen after it is in operation to verify the operations of the UV system and its interlocks.

Setting the Pressure Switches

1. Confirm the Ventilators are properly balanced and verify that if so equipped the Demand Control System is running at 100%.
2. Install all XGS Extractors.
3. Remove the UV Ballast Box Access Cover located on the roof of the canopy for each Ventilator section. A 7/16" Nut Driver will be needed. (Gently push up the inner cover, then slide over and down to remove)
4. Use a (SHORT) Philips screwdriver to remove the Cover Screws holding the Plastic Covers on both Pressure Switches, as shown in Figure 5-19-1.
5. Once the covers are removed, verify spade connectors are in place as shown in Figure 5-19-1.
CAUTION:*RISK OF SHOCK***** If the spade connectors shown are not in place turn off the power immediately. Follow the "Spade Connector not in Place Procedure" shown at the bottom of this Page.

UV Ballast Box - Cont.

Setting the Pressure Switches - Cont.

6. With gloves on and Ventilator running at 100%, turn the Adjustment Dial, as shown in Figure 5-19-1 on Pressure Switch "A", COUNTER CLOCKWISE until you hear a click, and the corresponding green LED lights illuminate on the Ventilation Control Board, shown in Figure 5-19-2. Then turn the Adjustment Dial Pressure Switch "B" COUNTER CLOCKWISE until you hear a "click". The green LED lights on the Ventilation Control Board will illuminate, and the green UVi SYSTEM ON light, on the Ventilator, will also come on. (NOTE: Both Pressure Switches need to be on for the UV system to turn on. LED lights will always come on when the pressure switch closes)
7. Once the UV Lamps are activated, all green LED lights on the Ventilation Control Board are illuminated, and the green UVi SYSTEM ON light on the Ventilator is illuminated, gently turn Pressure Switch Adjustment Dial on Pressure Switch "A", CLOCKWISE until the UV Lamps deactivate, then back again slowly COUNTER CLOCKWISE until the UV system comes back on. Repeat this process for Pressure Switch "B". The Pressure Switches are now set.
8. Replace the pressure switch covers.
9. Briefly secure the Ballast Box Access Cover. It must be in place to maintain proper pressurization in the Ballast Box enclosure.
10. **Test the System:** Remove the XGS Extractor(s) at one end of the Ventilator. The UVi SYSTEM ON light(s) must DEACTIVATE and the UV Lamps shut off immediately, less than one second. If they do not, place the XGS Extractors back in the Ventilator and repeat steps 3 through 9.
11. Repeat this process until the UVi SYSTEM ON lights remains illuminated, and the UV Lamps stay on.
12. Once the system is functioning properly, completely secure the Ballast Box Access Cover, and move on to the next Ventilator section. Repeat as needed.

Spade Connector not in Place Procedure:

1. Shut off Power to the UV Ventilator. Note: There are two breakers to deactivate.
 - a) 208/240 UV module power.
 - b) 120 VAC Power to the Command Center.
2. Verify power is shut down by checking voltage on terminal 6U on the Ventilation Control Board. Also check terminals L3/L4. Voltage for both needs to be 0. Refer to Figure 5-19-2.
3. Place a Spade Terminal on the live Terminal shown in Figure 5-19-1, for both Pressure Switches as needed. Return to "Setting the Pressure Switches".

UV Ballast Box - Cont.

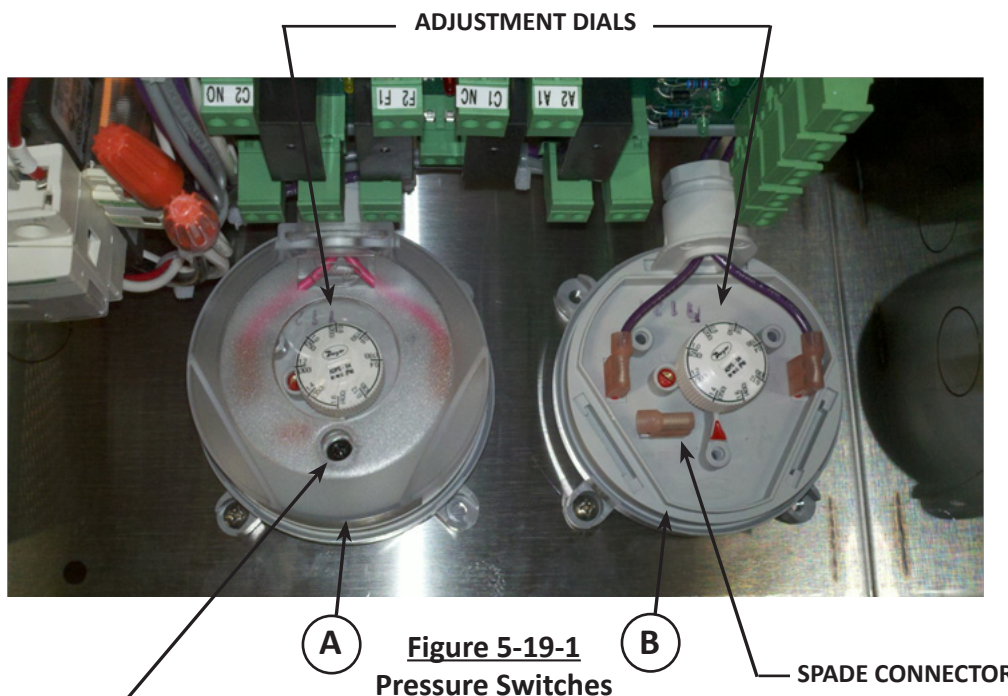

COVER SCREW

CAUTION: VERIFY SPADE CONNECTOR IS IN PLACE PRIOR TO ADJUSTMENT. IF IT IS NOT, FOLLOW "SPADE CONNECTOR NOT IN PLACE" PROCEDURE ON PAGE 5-18

TERMINALS L3 AND L4

GREEN LED LIGHTS

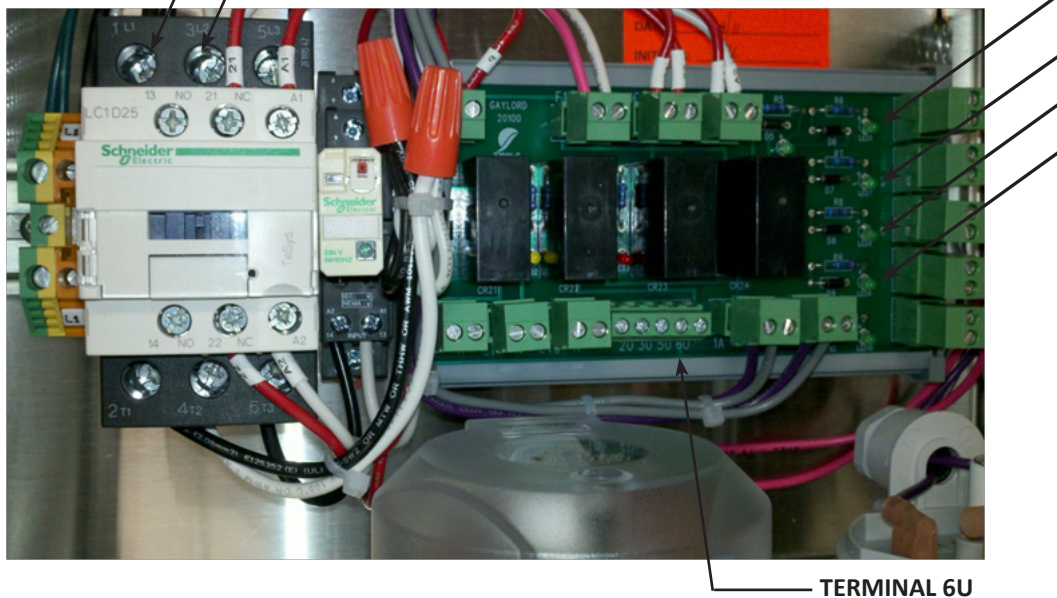

UV Ballast Box - Cont.



Figure 5-20-1
High Temperature
Shutdown Controller

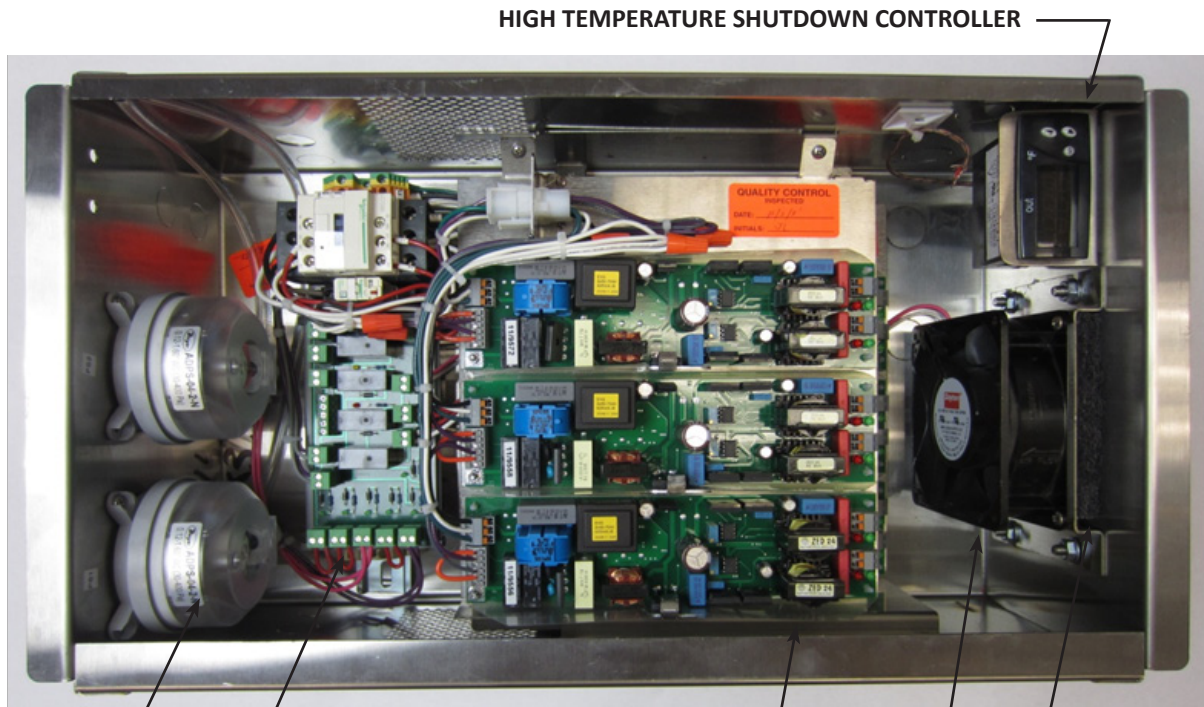

Figure 5-20-2
UV Ballast Box

PRESSURE SWITCHES

VENTILATION CONTROL BOARD

BALLAST BOARD

VENTILATION FAN

MESH FILTER

HIGH TEMPERATURE SHUTDOWN CONTROLLER

UV Ballast Box - Cont.

High Temperature Shutdown Controller

A High Temperature Shutdown Controller is mounted in the Ballast Box to monitor the internal temperature of the box and to shut down the UV System if the temperature in the Ballast Box exceeds 118°F. (Refer to Figure 5-20-2). Temperatures above 118°F may cause the Ballast Box components to fail. Activation of the High Temperature Shutdown Controller will shut off the UV system, turn on the Blue UVi System Standby status light mounted on the Ventilator, and the Gaylord Command Center will display text indicating a similar message as the status light. The exhaust fan will remain on. The High Temperature Shutdown Controller will typically activate for the following reasons:

1. The Ventilation Fan has failed. To replace the Ventilator Fan follow the instructions on page 5-16.
2. The Mesh Filter on the fan inlet is clogged or the inlet is blocked by building insulation or other material.
Corrective action: Clean or replace the Mesh Filter and/or remove any building insulation from the inlet.
3. The louvers at the opposite end of the Ventilation Fan are blocked by building insulation or other material.
Corrective action: Remove any building insulation from the inlet of the louvers.
4. Building insulation has been placed over the top of the Ballast Box. Corrective action: Cut a rectangular opening in the insulation, the size of the Ballast box, and slide it down around the sides of the box. Tape the insulation down so it will not interfere with the openings.
5. The cooking equipment under the Ventilator is in a “runaway” condition and operating too hot. Corrective action: Check with owner/equipment operator to see if cooking equipment is operating properly. If not, it must be serviced.

Important Note: The above conditions must be corrected or a UV Ballast failure will follow.

Checking the High Temperature Shutdown Controller Program

The High Temperature Shutdown comes programmed from the Gaylord factory and should never need to be reprogrammed. To check the program, use the following instructions:

1. Push the “**START FAN**” button on the Command Center. Check to insure that the Green UVi System On status light is on.
2. Confirm controller is showing current ambient temperature (Refer to Figure 5-20-1).
3. Briefly push Set, “SP” will appear.
4. Press Set a second time, then release. “118” will appear. If it does not, the control is either faulty or needs to be reprogrammed. Consult a Gaylord Service Agency or call Gaylord Industries for instructions.

UV Ballast Box - Cont.

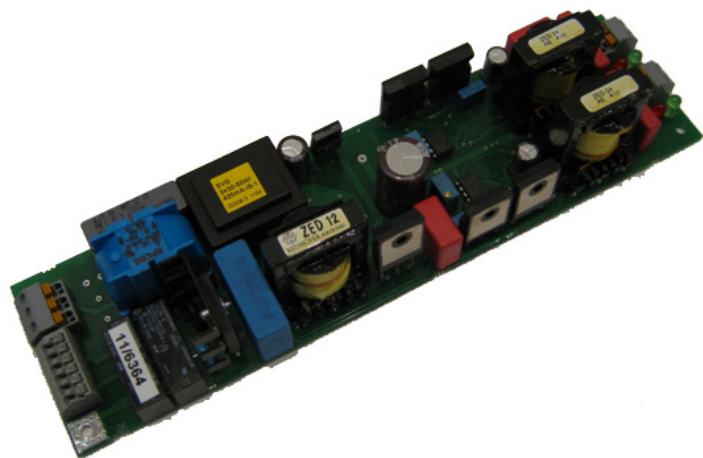

Figure 5-22-1
Ballast Board

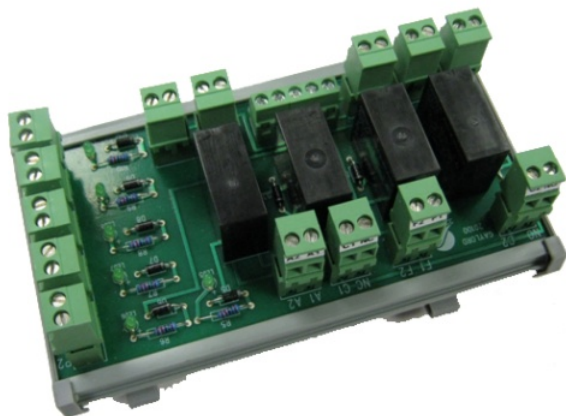

Figure 5-22-2
Ventilation Control Board



Figure 5-22-3
Safety Interlock Pressure Switch

Ventilator Water Solenoid Valves

Overview

There are two water Solenoid Valves located on the top of each Ventilator section. One is for Plenum Wash and one for the Extractor Wash (Refer to Figure A-5-1). The Solenoid Valves are controlled by the Gaylord Command Center.

Sticking Solenoid Valve

If water is running when the Command Center is not in a Wash Cycle it indicates that the Water Solenoid Valve is stuck in the open position. If this is the case, perform the following: (Refer to Figure 5-24-1)

1. Gently tap the valve housing with a hammer. This should release foreign material trapped in the valve and the water should stop.
2. If tapping does not release the foreign material the valve must be disassembled and checked. To disassemble the valve proceed as follows:

Danger: Always shut off electrical power when repairing electrical controls. Contact with unsecured power will result in immediate injury or death to personnel.

- a) Shut off electric power to the Wash Control Cabinet.
- b) Pry up the Red Cap on the top of the Solenoid and slide the Solenoid Coil off the coil stem.
- c) Remove the four bolts to separate the valve casing.
- d) Remove the valve diaphragm, inspect and clean. Clean both half's of the valve casing.
- e) Reassemble in reverse order.
- f) If the diaphragm looks worn or defective it should be replaced with a Solenoid Valve Repair Kit (Refer Chapter 6, Ventilator Parts).

If solenoid valve sticking is a recurring problem, it indicates that foreign material in the water supply line is escaping through the line strainer located in the Wash Control Cabinet. The screen in the line strainer should be removed, checked for holes, and cleaned. For instruction, refer to the Operation, Installation & Maintenance Manual for the Command Center / Wash Control Cabinet.

Solenoid Valve Not Opening

If a Solenoid Valve does not open when the system is placed into a Wash Cycle perform the following:

1. Check to see if there is electrical power at the solenoid coil. If there is no power refer to the Operation, Installation & Maintenance Manual for the Command Center / Wash Control Cabinet, the Troubleshooting Section.
2. If there is power it indicates that the Solenoid is burned out. To replace the Solenoid proceed as follows:

Danger: Always shut off electrical power when repairing electrical controls. Contact with unsecured power will result in immediate injury or death to personnel.

- a) Shut off electric power to the Wash Control Cabinet.
- b) Open the junction box next to the Solenoid Valve and disconnect the valve wires.
- c) Lift up the tab on the Solenoid Retainer and slide the retainer off.
- d) Slide the Solenoid Coil off the coil stem.
- e) Pull the wires out of the conduit going to the junction box.

Ventilator Water Solenoid Valves - Cont.**Solenoid Valve Not Opening - Cont.**

- f) Slide the wires from the new Solenoid through the conduit and into the junction box and connect the wires.
- g) Slide the new Solenoid onto the coil stem.
- h) Install the Solenoid Retainer.

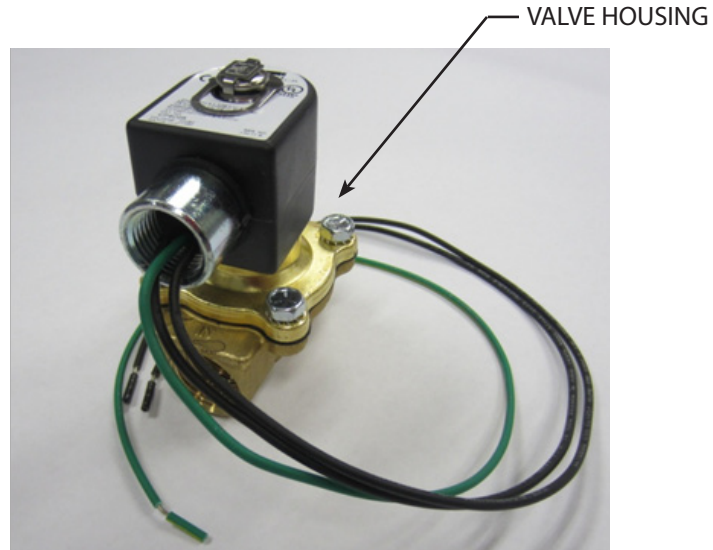

Figure 5-24-1
Water Solenoid Valve

Ventilator Spray Nozzles

Overview

There are two Wash Manifolds, one Extractor Wash Manifold and one Plenum Wash Manifold (Refer to Figure 2-12-2). Each manifold uses a different type of Spray Nozzle (Refer to Figures 5-25-1 and 5-25-2). For the Ventilator to Wash effectively all nozzles must be spraying during a Wash Cycle.

Clogged Spray Nozzles

To determine if there are clogged spray nozzles proceed as follows:

Caution: For this test it is recommended that eye protection is worn to protect the eyes from detergent injected water.

1. It is first necessary to cover all cooking equipment to protect from the water spray.
2. Close all Extractor Access Doors.
3. With the exhaust fan on, on the Command Center push the **EXTRACTOR WASH TEST** button. The Extractor Wash will come on for 60 seconds. While on, open each of the Extractor Access Doors individually and observe each nozzle for spraying. Note: For instructions to access the **EXTRACTOR WASH TEST** button, refer to the Operation, Maintenance & Installation Manual for the Command Center.
4. To test the Plenum Wash, it is first necessary to remove all the XGS Extractors.
5. Close all Extractor Access Doors.
6. With the exhaust fan off, on the Command Center push the **PLENUM WASH TEST** button. The Plenum Wash will come on for 60 seconds. While on, open each of the Extractor Access Doors individually and observe each nozzle for spraying. Note: For instructions to access the **PLENUM WASH TEST** button, refer to the Operation, Maintenance & Installation Manual for the Command Center.
7. If a nozzle is not spraying remove and clean by forcing air backward through the nozzle, or replace the nozzle.



Figure 5-25-1
Plenum Wash Spray Nozzle

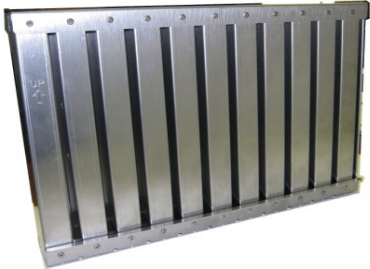





Figure 5-25-2
Extractor Wash Spray Nozzle

Ventilator Parts







Table T-6-1-1

Parts - Ventilator

PC No.	Description	Gaylord Part No.	Illustration
1	Extractor - Model XGS - Size 11" H x 16" L	76044	
2	Extractor - Model XG-SPA (Spark Arrester) Size 11" H x 16" L	76045	
3	100 Watt Surface Mounted Light Lens	10119	
4	12 x 12 Recessed Incandescent Light Lens and Retainer	13211	
5	48" Long Recessed Fluorescent Light Lens and Retainer	10112	
6	36" Long Recessed Fluorescent Light Lens and Retainer	10111	
7	LED Lamp for 48" Fluorescent Lights for 36" Fluorescent Lights for 48" Fluorescent Lights	20326 20327	
8	Water Solenoid Valve 3/4" Without Solenoid Coil (Parker Brand) Solenoid Coil	12028 12033	

Ventilator Parts





Table T-6-2-1

Parts - Ventilator - Cont.			
PC No.	Description	Gaylord Part No.	Illustration
1	Ventilator Exhaust Duct Collar Thermostat. 12" Long, NC Contacts, Factory set at 250 degrees F.	18465	
2	Ventilator Exhaust Duct Collar Thermostat. 15" Long, NC Contacts, Factory set at 250 degrees F. Note: For ELXC-BBC Series Only.	18466	
3	Static Tap	19545	
4	Damper Control Motor 24 Volts) For GFBD and GEBD Model Dampers	19176	
5	Spray Nozzle - For Extractor Wash	20329	
6	Spray Nozzle - For Plenum Wash (Pack of 2)	10303	

Ventilator Parts - Cont.

Table T-6-3-1

Parts - Ventilator - Cont.

PC No.	Description	Gaylord Part No.	Illustration
1	Autostart Sensor (new style)	20319	
2	Autostart Sensor (old style)	76004	
3	Autostart Controller complete with box	20317	
4	Autostart Controller only (No box provided)	20318	

Ventilator Parts - Cont.

Table T-6-4-1

Parts - UV Ventilator			
PC No.	Description	Gaylord Part No.	Illustration
1	UV Module - 3'-0", 6 Lamps (Includes Lamps)	76057	
2	UV Module - 5'-0", 6 Lamps (Includes Lamps)	76058	
3	3'-0" Lamp (single lamp)	20269	
4	5'-0" Lamp (single lamp)	20270	
5	UV Module/ Ballast Connector	20138	
6	UV Status Lamp - Green	19725	
7	UV Status Lamp - Yellow	19724	
8	UV Status Lamp - Blue	19723	
9	Gasket for UV Module Access Doors 3'-0" Module 5'-0" Module	20170 20171	
10	Lift & Turn Latch for UV Module Access Door	19351	

UV Ventilator Parts





Table T-6-5-1

Parts - UV Lamp Module				
Pc. No.	Description	Qty. per Module	Gaylord Part No.	Illustration
1	1/2-13 x 1-1/2 Round Head Slot Screw	4	20289	Not Illustrated
2	ELX UV Lamp Cover Washer	8	20288	
3	1/2-13 Hex Nut	4	20290	
4	1/4-20 x 3-1/4 Hex Head Bolt	4	20284	
5	1/4 Bonded SS Sealing Washer	8	20140	
6	Silicon Gasket for Lamp Module End Cap	2	20299	
7	UV Lamp Grommet	12	19312	
8	Heraeus UV Lamp 3'-0" Lamp (single lamp each) 5'-0" Lamp (single lamp each)	* *	20269 20270	
9	Panel Mount Pinned Receptical 20-27	1	20283	

* Lamps sold individually



UV Lamp Module Parts

Table T-6-6-1

Parts - UV Lamp Module - cont.			
Pc. No.	Description	Gaylord Part No.	Illustration
1	Pin Extractor Tool for Pinned Receptical Pin Insertion Tool for Pinned Receptical	20415 20414	
2	Pins, Male, for UV Pinned Receptical	20416	Not Illustrated
3	Single Pin UV Lamp Socket with 76" Halogen Free Wire and Connector Pin Shipped Loose.	19799	
4	Complete Single Pin UV Lamp Socket wiring harness for 6 Lamp Modules. Includes the short and long Lamp Socket wires pre-wired to the base of the Panel Mount Base Receptical. For 3'-0" Lamp Module For 5'-0" Lamp Module	20412 20413	
5	UV Module - 3'-0", 6 Lamp (Includes Lamps)	76057	
6	UV Module - 5'-0", 6 Lamp (Includes Lamps)	76058	

UV Lamp Module Parts - Cont.

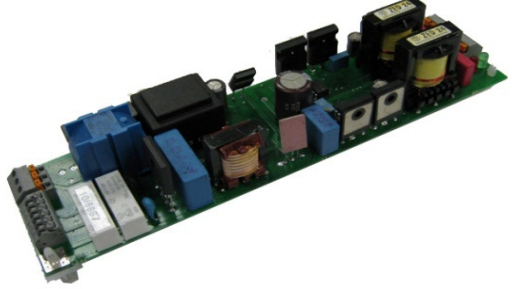
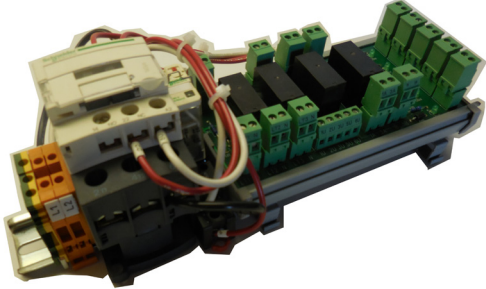
Table T-6-7-1

Parts - UV Ballast Box			
PC No.	Description	Gaylord Part No.	Illustration
1	Ventilation Fan	19430	
2	UV Ballast Board (complete)	22472	
3	UV Monitoring Board with Contactor - Complete Mounted on Din Rail	76029	
4	Contactor	30529	

UV Ballast Box Parts

Table T-6-8

Parts - UV Ballast Box - Cont.

PC No.	Description	Gaylord Part No.	Illustration
1	Relay	30833	
2	UV Pressure Switch	20489	
3	Vacuum Release Tube	20174	NOT ILLUSTRATED
4	Gasket for UV Ballast Box Access Cover 11-1/2" x 20" 16" x 16"	20173 20172	
5	1/4-20 Chrome Acorn Nut for UV Ballast Box Cover Bonded Sealing Washer	10766 20140	

ELXC-GBD with AUTOSTART

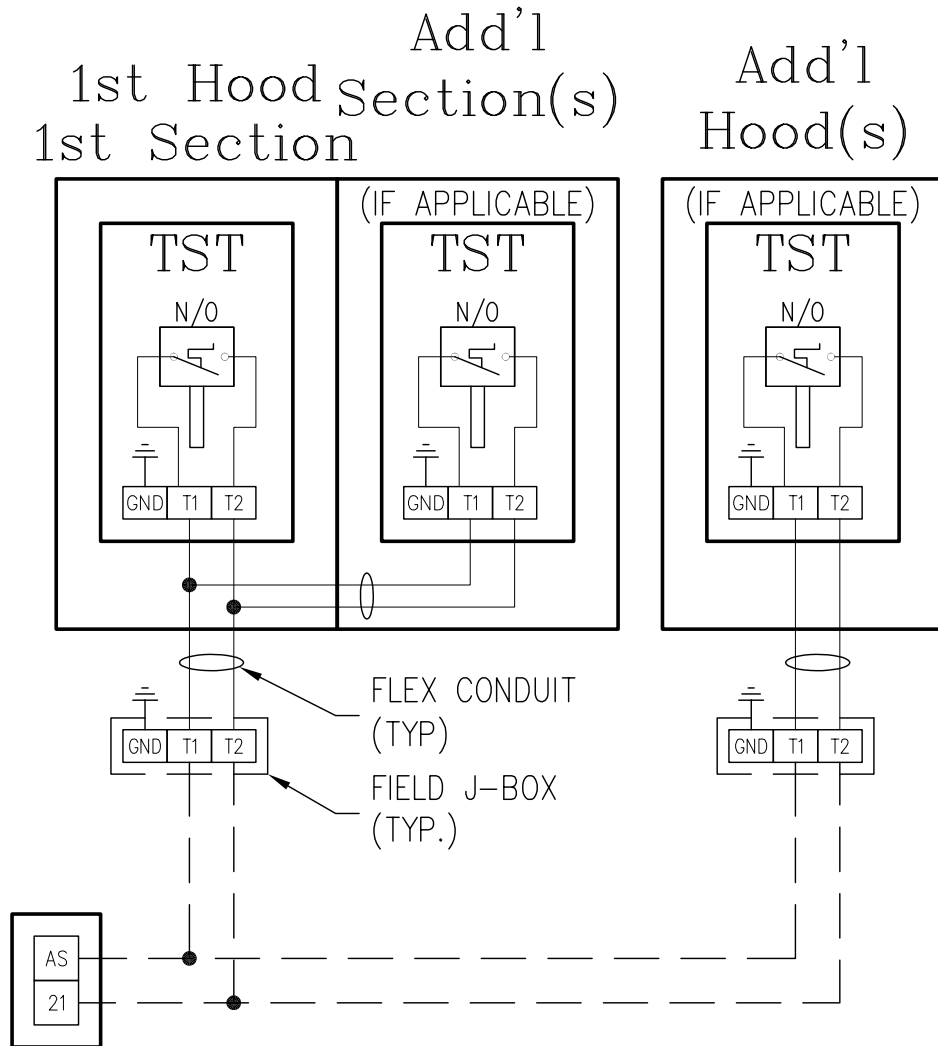

REFER TO
WASH CONTROL
CABINET WIRING
DIAGRAM FOR
DETAILS

ELXC-GFBD with AUTOSTART

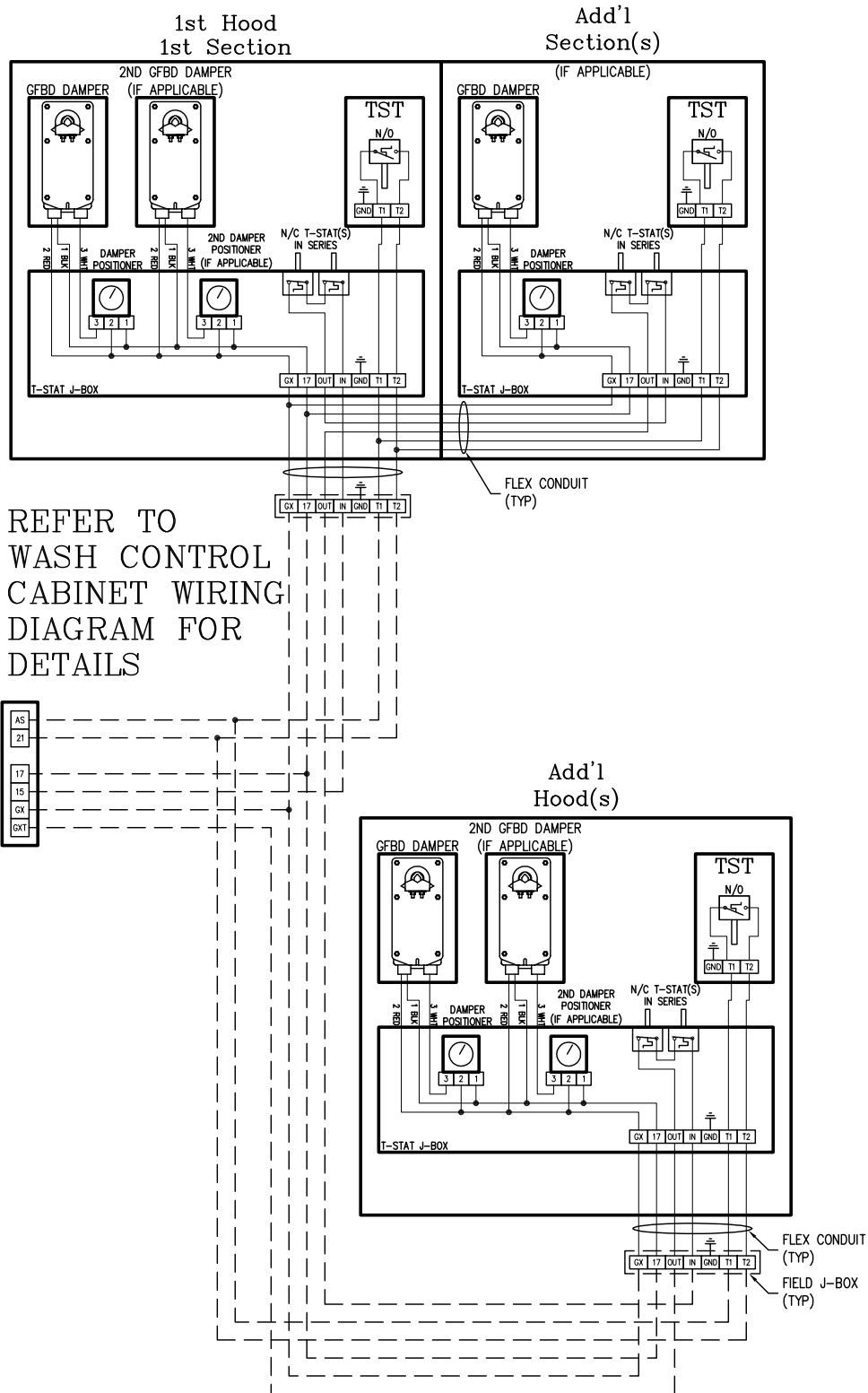

ELXC-GBD-UVi with AUTOSTART

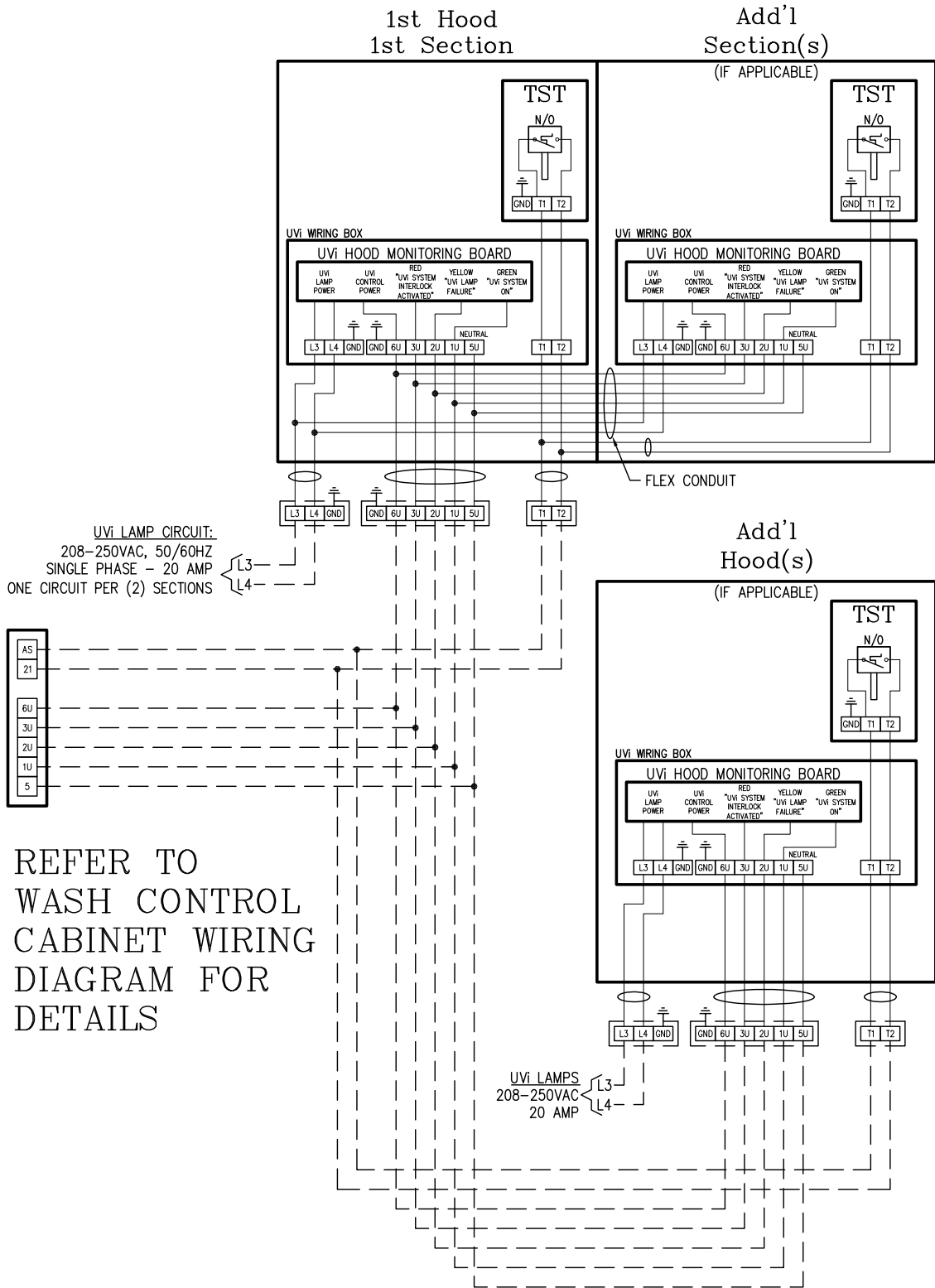

ELXC-GFBD-UVi with AUTOSTART

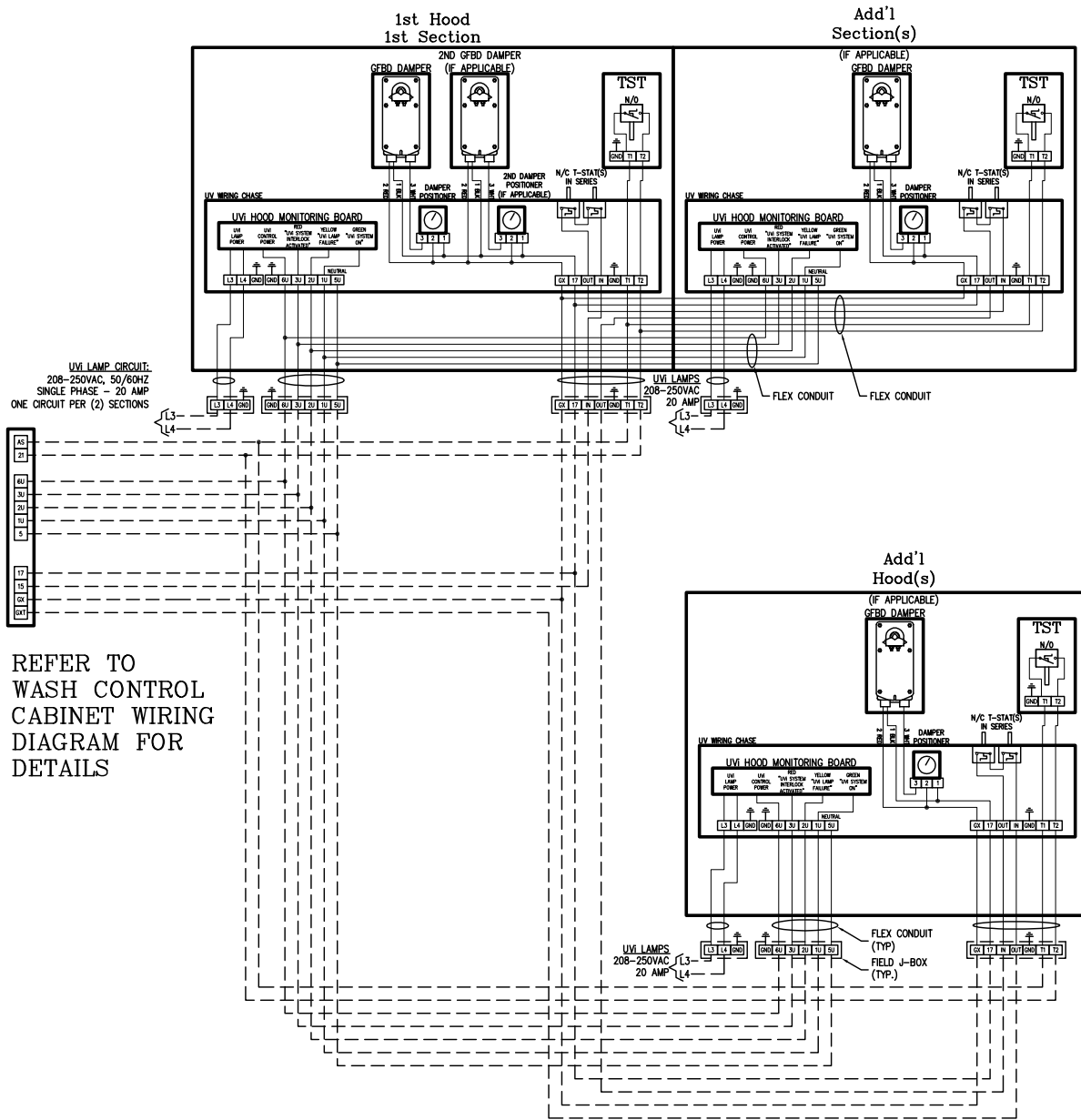

Installation Requirements

Code Compliance

Ventilators must be installed to comply with all applicable codes.

1. Ventilator to be installed in accordance with NFPA-96, Standard for Ventilation Control and Fire Protection of Commercial Cooking Operations, the IMC, International Mechanical Code, and all other local applicable codes.
2. All plumbing and electrical must comply with the applicable codes.
3. Contractors must review applicable codes with code authorities before approving drawings for fabrication.
4. Special attention must be given to code regulations relative to clearances from surrounding combustible constructions (walls, ceilings, etc.).

Permits

IMPORTANT NOTE: Most building departments require the Ventilator (hood) permit separate from any other general building permit. In addition if a Fire Extinguishing System is involved a separate permit from the Ventilator permit is typically required. The Ventilator permit is typically obtained through the plan review department and the Fire Extinguishing System permit through the fire prevention bureau. The installing contractor must check with local building departments for their requirements, and to obtain necessary permits.

Ventilator Listing

The Gaylord Model ELXC and ELXC-UVi Series Ventilators are listed to UL 710, UL 710C respectively, and Recognized by ETL. Any modification made to the Ventilator at the jobsite will void the listing.

Hanging the Ventilator

Use the following guidelines for hanging the Gaylord Ventilator:

1. The maximum section length of a Gaylord Ventilator is 16'-0". Ventilators longer than 16'-0" are made up of multiple sections.
2. The weight of the Ventilator is shown on the Gaylord Submittal Drawings.
3. Each Ventilator section has a full length Rear Mounting Bracket at the rear for bolting to the wall and/or hanging from the overhead. There are two other full length hanging brackets; the Middle Mounting Bracket and the Front Mounting Bracket for hanging from the overhead (refer to Figure A-2-1). All three Hanging Brackets have pre-punched holes centers for hanging from the overhead. Hanging rods to be supplied by the Ventilator installer. If the rear bracket is used for bolting to the wall the holes must be drilled by the installing contractor at a support point in the wall. Refer to Table T-A-2-1 for minimum number of mounting points.
4. It is recommended that the number of hanging rods used be no less than the recommend minimum as shown on Table T-A-2-1.
5. The Ventilator(s) must be installed at the distance from the finish floor and the minimum side overhang dimension from the end of the Ventilator to the cooking equipment as shown on the Gaylord Submittal Drawings.
6. When there is a continuous Ventilator made up of two or more sections it is recommended that each Ventilator section is hung individually. Angles are provided at the top of the sections for bolting together. The bolts are provided by Gaylord. Hem strips and bolts are provided by Gaylord for joining the Ventilators on the underside where visible.

Installation Requirements - cont.

7. **Caution:** When installing Ventilators incorporating a UV system, ELXC-UVi Series, do not cover the UV Ballast Box, mounted on top of the Ventilator, with building insulation. Covering the Ballast Box inlet and outlet ventilation openings will cause the box to overheat which could result in failure of electrical components. Covering the Ballast Box with insulation will damage the Ventilator and void the Warranty.

Table T-A-2-1

Recommend Minimum Mounting Devices					
Rear Mounting Bracket, Bolting to Wall or Hanging With Rods		Middle Mounting Bracket Hanging Rods		Front Mounting Bracket Hanging Rods	
Max. Distance From End of Ventilator Section	Max. Spacing Between Supports	Max. Distance From End of Ventilator Section	Max. Spacing Between Supports	Max. Distance From End of Ventilator Section	Max. Spacing Between Supports
12"	72"	36"	72"	12"	72"

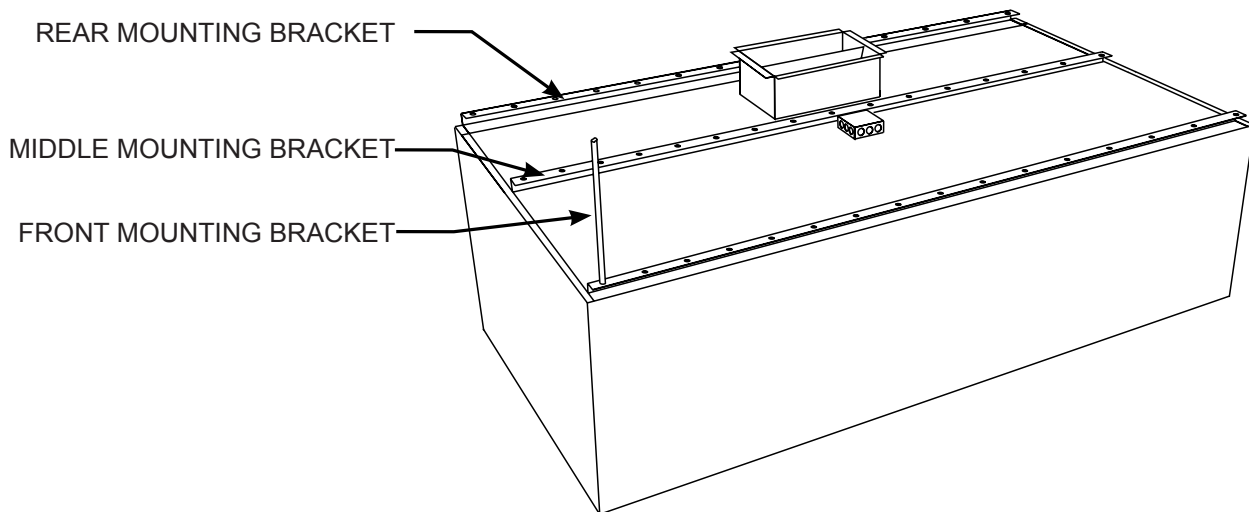

Figure A-2-1
Ventilator Hanging Points

Installation Requirements - cont.

Ductwork

Grease exhaust ducts must be installed in compliance with NFPA-96, IMC and other applicable codes. Use the following guidelines when installing the exhaust ducts:

1. Exhaust ducts must be constructed of 16 gauge steel or 18 gauge stainless steel.
2. Exhaust ducts must be constructed with continuous external welds and be grease and water tight.
3. Exhaust duct must be continuously welded to the Ventilator duct collar.
4. All elbows should be sweeping 90's. Right angle turns or elbows less than sweeping may negatively impact the performance of the Ventilator.
5. All horizontal ducts should slope towards the Ventilator and/or towards an approved sump. Amount of slope must be in accordance with the IMC.

Electrical

Refer to the wiring diagrams on the Gaylord Submittal Drawings for specific wiring interconnections.

1. Provide a 120 volt 20 amp service to the Gaylord Command Center. Optional Voltage 220 volt 50/60 Hz.
2. Wire the Command Center to the designated flex conduit at one end of the Ventilator in accordance with the electrical diagram.
3. Wire the Command Center to the exhaust and supply fan(s).
4. If the Ventilator is built in multiple sections, and if they contain electric dampers, or thermostats, reconnect the flex conduit provided at the section breaks. The electrical contractor is responsible for making these connections.
5. If the Ventilator is provided with light fixtures, provide a separate 120 volt lighting circuit to one of the light J-box on the top of the Ventilator. Ventilator may be equipped with built-in light switch.
6. Ventilators built in multiple sections have a flex conduit at the section breaks for interconnecting the light fixture J-boxes. The electrical contractor is responsible for making these connections.

Additional Electrical for Ventilators with a UV System

Refer to the wiring diagrams on the Gaylord Submittal Drawings for specific wiring interconnections.

1. The UV Lamp Modules are shipped with the Ventilator. They are installed and tested by a Gaylord Certified Representative at the time of initial Start Up and Demonstration. They must be stored in a clean, dry environment where they will not be damaged by lift trucks, falling objects, etc.
2. Provide 208–250 VAC, 50/60HZ, Single Phase, 20AMP service to the marked j-box on the top of each Ventilator section to power the UV Lamp Modules.
3. Ventilators built in no more than two sections have a flex conduit to interconnect the two UV Ballast Boxes. The electrical contractor is responsible for making this reconnection.

Plumbing (Refer to Figure A-5-1)

Refer to the plumbing diagrams on the Gaylord Submittal Drawings for specific plumbing sizes, and plumbing interconnections.

1. Provide a hot supply to the Wash Control Cabinet. Note: water temperature requirements 140° F. Min. to 180° Max., water pressure requirements 40 psi Min. to 80 psi Max.
2. Plumb one 1.00" line from the Wash Control Cabinet to the two connections points on top of each Ventilator section.
3. Run a drain line from the Ventilator drain stub out to a floor sink, or direct connect, as specified. Some Ventilators built in multiple sections the drains may interconnect. The plumbing contractor is responsible for making these connections.
4. Run a drain line from the drain stub out on the bottom of the Wash Control Cabinet to a floor sink, or direct connect, as specified.

Installation Requirements - cont.

Air Flow Rates

The exhaust air flow rate (and supply if part of the Ventilator) must be set at the rate stamped on the Ventilator nameplate. The exhaust volumes (and supply when provided) were established under controlled laboratory conditions and greater exhaust and/or lesser supply may be required for complete grease, smoke and vapor removal in specific situations.

Fire Extinguishing System

NFPA-96 requires a Fire Extinguishing System in all Ventilators that cover cooking equipment producing grease laden vapors. In many cases the Fire Extinguishing System is pre-piped by Gaylord Industries in the factory with completion of the system by a local Fire System contractor. If not pre-piped then the entire system would be installed by a local Fire System contractor. Use the following guidelines:

1. Fire Extinguishing System furnished must be in accordance with the terms of its listing and the applicable NFPA or IFC codes and standards.
2. Caution: Fire extinguishing system piping installed on the Ventilator at jobsite should be coordinated with Gaylord Industries to ensure piping does not interfere with the Ventilator's operation and performance. Improper installation may void Listings of the Ventilator.
3. IMPORTANT NOTE: NFPA-96 requires that all gas cooking equipment, and electric cooking equipment that is protected by a Surface Fire Extinguishing System must automatically shut off upon activation of the system.
4. Most building departments require a separate Fire Extinguishing System permit from any other general building or Ventilator permit. Installing contractor to check with local building departments for their requirements, and to obtain necessary permits.

Installation Requirements - cont.

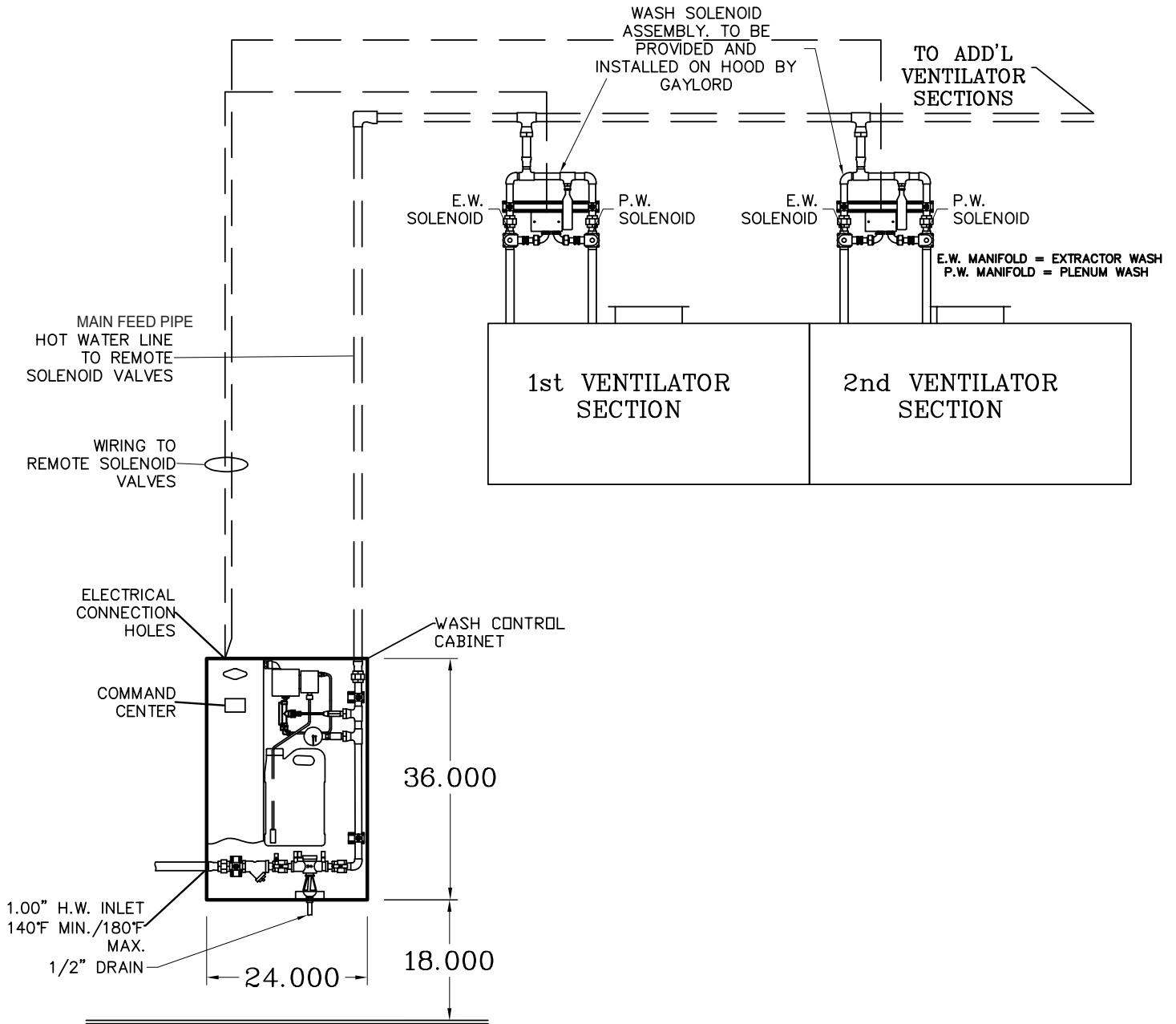

Figure A-5-1
Typical Installation



INTENTIONALLY LEFT BLANK

Ventilator Start-Up Inspection And Tests

Overview

As one of the benefits of purchasing a Gaylord ELXC or ELXC-UVi Series Ventilator is a complete Start-Up Inspection is performed by a Gaylord Authorized Representative or a Gaylord Certified Service Agency. These tests must be conducted prior to use by the operator. Typically at the time the Start-Up Inspection is performed, the operation and general maintenance of the Gaylord equipment is demonstrated and described to the operating personnel. It is the responsibility of the Gaylord Authorized Representative or Agency to coordinate the date of Start-Up with any personnel such as the GC, owner, owner's rep, Fire Marshall, fire protection contractor, air balancer etc., required to witness the Start-Up.

For the ELXC Series Ventilator (without UV Lamps) the Authorized Representative or Agency uses the form titled Ventilator Start-Up Inspection Report, as shown on page B-3 of this manual. For ELXC-UVi Series Ventilator (with UV Lamps) both forms Ventilator Start Inspection Report and UV Start-Up and Test Report, page B-4, are used.

The UV Lamp Modules for ELX-UVi Series are shipped by Gaylord Industries directly to the jobsite. A Gaylord Authorized Representative or Agency will install the modules at the time of Start-Up.

Pre Start-Up Requirements

Before a Gaylord Start-Up can be performed, the responsible contractor or dealer must have the Ventilator installed and operating. The following is a check list of items that must be completed prior to a Start-Up being conducted.

Pre Start-Up Check List

- Ventilator is installed above cooking equipment as per Gaylord Submittal Drawings.
- The exhaust ductwork is connected to the Ventilator and the exhaust fan.
- The supply ductwork is connected to the ceiling diffusers and the make-up air fan (system).
- The exhaust fan is operational and is running in the correct direction.
- The make-up air system is operational.
- All required electrical connections between the Gaylord Command Center and the Ventilator, Building Management Systems, Remote Monitoring Systems, and Fire Extinguishing Systems are completed per plans, and are operational.
- Ventilators built in multiple sections are inter-wired.
- The Ventilator lights are wired and operational.
- Hot water supply is connected to the Wash Control Cabinet.

Ventilator Start-Up Inspection And Tests - cont.

- ___ Hot water lines from the Wash Control Cabinet to the Ventilator(s) are connected and operational.
- ___ Ventilators built in multiple sections the hot water interconnections between sections are complete.
- ___ All drain(s) are plumbed to the floor sink or other drain.
- ___ Fire Extinguishing System installed and certified.
- ___ All Gaylord XGS Extractors are installed in the Ventilator(s).

For ELXC-UVi Series Ventilators

- ___ There is a 208–250 VAC, 50/60HZ, Single Phase, 20AMP circuit going to the Ballast Box on the top of each individual Ventilator section. One power source will serve a two section Ventilator.
- ___ If the Ventilator is built in two sections, the interconnection of the two UV Ballast Boxes is complete.

Ventilator Start-Up Inspection And Tests - cont.

Ventilator Start-Up Inspection and Test Report

For Gaylord Model ELXC and ELXC-UVi Series Ventilators

Facility Name _____	Gaylord Representative Company Name _____
Address _____	_____
City _____ State _____ Zip _____	Gaylord Rep Name _____
Facility Contact Name _____	Signature _____
Facility Contact Phone # _____	Date of Start-Up _____
Facility E-Mail _____	Gaylord File Number _____

Exhaust Volume Readings

1. Push the START FAN button on the Gaylord Command Center. The exhaust fan should come on. Note; if the Ventilator includes an electric damper it may take up to 45 seconds for the exhaust to come up to 100%. Did the exhaust fan come on. Yes ____ No ____
2. Determine the exhaust volume for each Ventilator section by either the Static Pressure Method or the Velocity Method as detailed in the ELXC Series Operation, Maintenance and Installation Manual. Record all readings in the chart below. Record the Design CFM from the Gaylord Drawings or the Ventilator Nameplate. If the installation includes a Plenum Box make up air system, take velocity readings and record on the chart.

Exhaust Volume Test Chart - Example											
Item No.	Ventilator Description	Length	Ventilator Serial #	Plenum Box FPM	Plenum Static		Inlet Velocity		Total CFM		% + or -
					Design	Actual	Design	Actual	Design	Actual	
K-112	Griddle Fryer Line	10'-0"		125			664	610	1440	1325	-8%
K-114	Oven Kettle Line	16'-0"		110	0.22	0.28			2512	3039	21%

Exhaust Volume Test Chart											
Item No.	Ventilator Description	Length	Ventilator Serial #	Plenum Box FPM	Plenum Static		Inlet Velocity		Total CFM		% + or -
					Design	Actual	Design	Actual	Design	Actual	

Make-Up Air

1. When the Exhaust Fan is on the Make-Up Air should be on. Is the Make-Up air on. ... Yes ____ No ____
2. Type of Make-Up Air discharge.
 - ____ Ceiling Registers located approximately ____ ft. in front of Ventilator.
 - ____ Ceiling Plenum Box located immediately in front of Ventilator. Dimension from bottom of Ventilator to discharge screen of Plenum Box. _____
 - ____ Ceiling Plenum Box located approximately ____ ft. in front of Ventilator.
 - ____ Linear Diffusers or registers located approximately ____ ft. in front of Ventilator.
 - ____ Other _____

Ventilator Start-Up Inspection And Tests - cont.

Ventilator Start-Up Inspection and Test Report

For Gaylord Model ELXC and ELXC-UVi Series Ventilators

Wash Mode Test

1. Gaylord Command Center; Model # _____ Serial # _____
2. Push the TEST WASH button on the Gaylord Command Center. The Extractor Wash for Ventilator #1 should come on for 10 seconds and then hood # 2 etc. until all Ventilators sections have completed the Extractor Wash. The Plenum Wash should then come on for 10 second for each Ventilator section.

While in a test wash mode check the following:

Ventilator Check

- a. All Extractor Washes came on and all nozzles spraying Yes No
- b. All Plenum Washes came on and all nozzles spraying Yes No
- c. Any water leaks. Yes No
- d. At conclusion of the wash the water shut off Yes No

Wash Control Cabinet Check

- a. Any water leaks Yes No
- b. Detergent pump is primed and pumping Yes No
- c. Water pressure is: (40 psi Min. to 80 psi Max.) psi
- d. Water temperature is: (140° F. Min. to 180° F. Max.) ° F.
- e. Brand of detergent used _____

Frequency and Length of Wash

1. Record the Equipment Duty, and the Length of the Wash Cycle programmed in the Gaylord Command Center for each Ventilator section. Record the Delay between Washes.

Programmed Frequency and Length of Wash Chart – Example						
Ventilator Section #	Ventilator Description	Length	Extractor Wash		Plenum Wash	
			Equipment Duty*	Length of Wash in Min.	Equipment Duty*	Length of Wash in Min.
1	Griddle Fryer Line	10'-0"	LMD	3	LMD	3
2	Oven Kettle Line	16'-0"	LD	3	LD	3
Length of Delay Between Wash Cycles <u>10</u> Min.						

Programmed Frequency and Length of Wash Chart						
Item No.	Ventilator Description	Length	Extractor Wash		Plenum Wash	
			Equipment Duty*	Length of Wash in Min.	Equipment Duty*	Length of Wash in Min.
Length of Delay Between Wash Cycles _____ Min.						

Equipment Duty Key: Light Duty = **LT**, Light/Medium Duty = **LMD**, Medium Duty = **MD**, Heavy Duty = **HD**, Extra Heavy Duty = **EHD**

Ventilator Start-Up Inspection And Tests - cont.

Ventilator Start-Up Inspection and Test Report

For Gaylord Model ELXC and ELXC-UVi Series Ventilators

Damper Test

1. Model of Damper.
 - No Damper. No test required, proceed to next test.
 - Model GBD manual Gaylord Balancing Damper. No test required, proceed to next damper.
 - Model GEBD Gaylord Electric Balancing Damper. Proceed to Electric Balancing Damper Test.
 - Model GFBD Gaylord Fire Balancing Damper. Proceed to Gaylord Fire Balancing Damper Test.

Gaylord Electric Balancing Damper Test (Damper Model GEBD)

1. Ventilators with this model damper, the damper opens every time the exhaust fan is turned on and closes every time it is shut off. To test proceed as follows:
 - a) With the exhaust fan off, open the Extractor Access Door and remove the Extractor under the exhaust duct. To test, proceed as follows:
 - 1) With the fan off, the damper should be closed. Closed Open
 - 2) Start the fan. The damper should move to the open position Yes No
 - b) Replace Extractor and close the Extractor Access Door.

Gaylord Electric Fire Balancing Damper Test (Damper Model GFBD)

1. **Caution:** Performing this test may set off the building fire alarm system and may notify the fire department. Notify building management/maintenance and disable the building alarm system is necessary.
2. Ventilators with this model damper including a thermostat, that when activated by high heat or fire, closes the damper. This test is also called an Internal Fire Mode Test. To test proceed as follows:
 - a) Push the Internal Fire Mode Test button on the Gaylord Command Center. The following should occur:
 - 1) The exhaust fan should be off. Off On
 - 2) The make-up air should be off. Off On
 - 3) Extractor and Plenum washes should be off. Off On
 - 4) If Ventilator includes UV, it should have shut off. Off On
 - 5) Gaylord Command Center display should read Fire In Hood. Yes No
 - b) With the exhaust fan off, open the Extractor Access Door and remove the Extractor under the exhaust duct. Fire Damper should have closed. Yes No
 - c) Replace Extractor, close Extractor Access Door and start fan.

Installation Includes the Following Equipment

- Gaylord Autostart Control.
- Gaylord Clearair Pollution Control Unit. (RSPC)
- Gaylord Distributor. (UDS)
- Fire Extinguishing System. Manufacturer _____

Ventilator Start-Up Inspection And Tests - cont.

UV Start-Up Inspection and Test Report

For Gaylord Model ELXC-UVi Series Ventilators

Facility Name _____ Address _____ City _____ State _____ Zip _____ Facility Contact Name _____ Facility Contact Phone # _____ Facility E-Mail _____ This Report is for Ventilator: _____	Certified Service Agency (CSA) Company Name _____ _____ CSA Print Name _____ Signature _____ Date of Start-Up _____ Gaylord File Number _____
--	--

Overview

This UV Start Up Inspection and Test Report must be performed by a Gaylord Certified Service Agency (CSA). UV Lamp Modules are shipped separate from the Ventilator to a CSA for installation, and to perform this UV Start-Up Inspection and Test. CSA, complete this form for each Ventilator section. Allow about one hour for each Ventilator section.

Important Note: Before this UV Start-Up Inspection and Test can be performed, the Ventilator Start-Up Inspection Report must be completed, and all Fire Protection Systems installed, certified and signed off by the Fire Marshall.

Installation of UV Lamp Modules

1. Check that all XGS Extractors are properly installed. Yes No
2. Open the UV Module Access Doors and slide in the UV Lamp Modules.
3. Once installed, connect the Lamp Ballast Connectors to the UV Lamp Modules.
4. Close the UV Module Access Doors and latch.

UV Safety Interlock Test for Extractors

1. Set the Safety Interlock Pressure Switches in accordance with the Gaylord Installation, Operation, and Maintenance Manual. Once the Pressure Switches have been set proceed to step 2.
 Pressure Switches have been set. Yes No
2. Double check to make sure all XGS Extractors are in place. Start the exhaust fan. The green UV System Status light should come on. On Off
 If the system fails to come on refer to the UV System Troubleshooting section of the Gaylord Installation, Operation, and Maintenance Manual for ELXC and ELXC-UVi Series Ventilators.
3. With the exhaust fan on, open the Extractor Access Door and remove the left end Extractor, observe the Status Light, and replace the extractor. Continue the test by removing the middle and then the right end Extractor. With any one of the three Extractors removed the system should de-activate immediately and the red UVi System Standby light should come on.
 - a) Left end Extractor removed, UVi System Standby light should be on. On Off
 - b) Middle Extractor removed, UVi System Standby light should be on. On Off
 - c) Right end Extractor removed, UVi System Standby light should be on. On Off
 If the light does not come on refer to the UV System Troubleshooting section of the Gaylord Installation, Operation, and Maintenance Manual for ELXC and ELXC-UVi Series Ventilators.
 - d) All Extractors replaced and Extractor Access Door Closed. Yes No

Ventilator Start-Up Inspection And Tests - cont.

UV Start-Up Inspection and Test Report
For ELXC-UVi Series Ventilators

UVi System Standby Test for Open UV Module Access Door

- 1. Caution: For this test eye protection must be worn. With the fan on open one UV Module Access Door. Note: If there are two different sizes of doors, open the shortest one. The system should de-activate immediately and the blue UVi System Standby light should come on.
2. Close the UV Module Access Door. The green UV System On status light should come back on.

Instructions from the Gaylord Certified Service Agency to the Owner/Operator/End User

After the Inspection and Tests has been successfully completed, demonstrate and review the following with the Owner/Operator/End User.

- 1. Explain the Principles of Operation as shown on pages 6 and 7.
2. Thoroughly review the Operator Maintenance and Cleaning Instructions as described on page 8.
3. Explain that the Ventilator and UV System must be on a scheduled maintenance program, in accordance with NFPA-96, and that it can only be performed by a Certified Service Agency.
4. Explain the hazards of UV light if the Owner/Operator/End User services the UV System.
5. Provide a copy of the Gaylord Installation, Operation, and Maintenance Manual for ELXC and ELXC-UVi Series Ventilators.
6. Provide a copy of the Gaylord Command Center Technical Manual.
7. Provide a copy of this UV Start-Up Inspection and Test Report.

Note to Operator: You may obtain a free copy of the Gaylord Installation, Operation, and Maintenance Manual and the Gaylord Command Center Technical Manual by visitinwww.gaylordventilation.com.

Owner/Operator/End User Acknowledgement

Please sign this form to acknowledge that the Gaylord Certified Service Agent has thoroughly explained items 1 through 4 above, and provided documents listed in items 5 through 7 above.

Signature
Print Name
Company Name
Title Date

Comments

Horizontal lines for writing comments.

THE GAYLORD VENTILATOR LIMITED WARRANTY FOR MODELS ELXC AND ELXC-UVi SERIES

July 2011

The Gaylord Ventilator and component parts furnished with The Gaylord Ventilator are warranted to be free from defects of material and workmanship under normal use when installed, operated and serviced in accordance with factory recommendation. Rubber and synthetic rubber parts such as "O" rings, diaphragms, poppet checks, and gaskets are perishable when caustic cleaning solutions are used and, therefore, are not covered by this warranty.

The Manufacturer's obligation under this warranty and any warranties implied by law shall be limited to repairing or replacing at its option any part of said equipment when either Gaylord Industries, Inc. or the Licensed Gaylord Manufacturer's examination shall disclose to its satisfaction to be thus defective, for a period of one (1) year from the date of beneficial use, or eighteen months from date of shipment, whichever occurs first, provided proper and acceptable evidence of such is recorded at the factory. Note GAYLORD INDUSTRIES AND THE LICENSED GAYLORD MANUFACTURER SHALL NOT BE RESPONSIBLE FOR INCIDENTAL OR CONSEQUENTIAL DAMAGES RESULTING FROM A BREACH OF THIS WARRANTY.

In the United States, the labor required to make repairs and replacements under this warranty shall be furnished by Gaylord Industries or the Licensed Gaylord Manufacturer or its authorized representative. Such labor shall only be provided Mondays through Fridays during standard work hours, at straight time rates. Requests for repairs or replacement parts should be made to GAYLORD INDUSTRIES, 10900 SW Avery Street, Tualatin, Oregon 97062.

Outside the United States, all replacement parts furnished under this warranty shall be F.O.B. Gaylord Industries, Tualatin, Oregon U.S.A. The owner shall pay the necessary freight delivery charges, and necessary labor for removal and installation of parts, and any tariffs, duties or taxes.

Component parts not manufactured by Gaylord Industries, such as electrical switches, solenoid coils, relays, etc., shall be warranted under the terms and conditions of the warranty published by the manufacturer of said component parts.

This warranty does not cover routine maintenance such as detergent replacement and inspection of the cleaning system and UV system as spelled out in The Gaylord Ventilator Technical Manual. This warranty also does not cover malfunctions or improper operation caused by inadequate hot water, low water pressure, fluctuating electrical power or power surges, waste stoppages, and improper exhaust fan operation and/or a lack of proper maintenance.

This is the sole warranty with respect to the aforesaid items. NEITHER GAYLORD INDUSTRIES OR THE GAYLORD LICENSED MANUFACTURER OR ANY OTHER PARTY MAKES ANY OTHER WARRANTY OF ANY KIND WHATSOEVER, EXPRESSED OR IMPLIED, AND ALL IMPLIED WARRANTIES OF MERCHANTABILITY AND FITNESS FOR A PARTICULAR PURPOSE WHICH EXCEED THE AFORESAID OBLIGATIONS ARE HEREBY DISCLAIMED AND EXCLUDED FROM THIS AGREEMENT.

Service and Warranty Policies

1. No warranty work shall be performed on the product without a PO from Gaylord Industries, if financial reimbursement to be requested.
2. No warranty shall be provided on equipment that has been started up and in operation for more than 90 days unless, a product maintenance schedule has been created and performed per the requirements of this technical manual.
3. Any, and all, wearable parts are not to be considered warranty items, regardless of installation date, unless previously authorized by the factory.



**WORLDWIDE SALES, MANUFACTURING AND SERVICE
FOR THE NAME AND LOCATION OF THE NEAREST
CERTIFIED SERVICE AGENCY, VISIT OUR WEB SITE:**

WWW.GAYLORDVENTILATION.COM

OR CONTACT US AT:

GAYLORD INDUSTRIES

10900 SW AVERY STREET
TUALATIN, OREGON 97062 U.S.A

Phone: 503-691-2010

1-800-547-9696

Fax: 503-692-6048

email: info@gaylordventilation.com

LOCAL SERVICE AGENCY