

Master “M” Series Gas Upright Broilers

Parts List

Models:

M100XRM

M100XRCM

M100XSM

M100XTM

Rating Plate Location

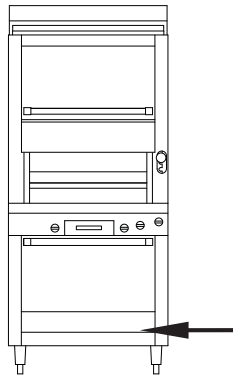

Model with an Oven Base.

The Rating Plate is affixed to the front edge of the chassis bottom, behind the front kick plate.

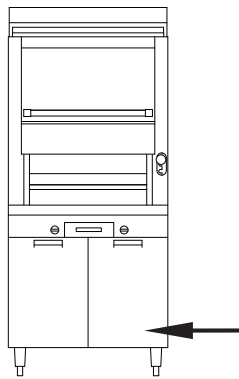

Model with a Storage Base.

The Rating Plate is affixed to the inside of the right cabinet door.

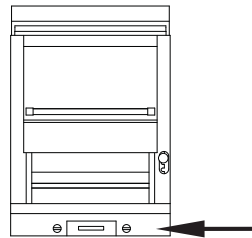

Modular Top Model.

The Rating Plate is affixed to the bottom panel, behind the valve panel.

Serial# Interpretation

The Serial Number is **13 Digits** long.





Master Series Heavy Duty Gas Upright Broilers

models

M100XRM, M100XRCM

M100XSM, M100XTM

Contents

Introduction / Rating Plate Location / Serial# Interpretation	2
Components.....	4
Critical & Recommended Stock Parts List.....	10
Revision History.....	11

COMPONENTS

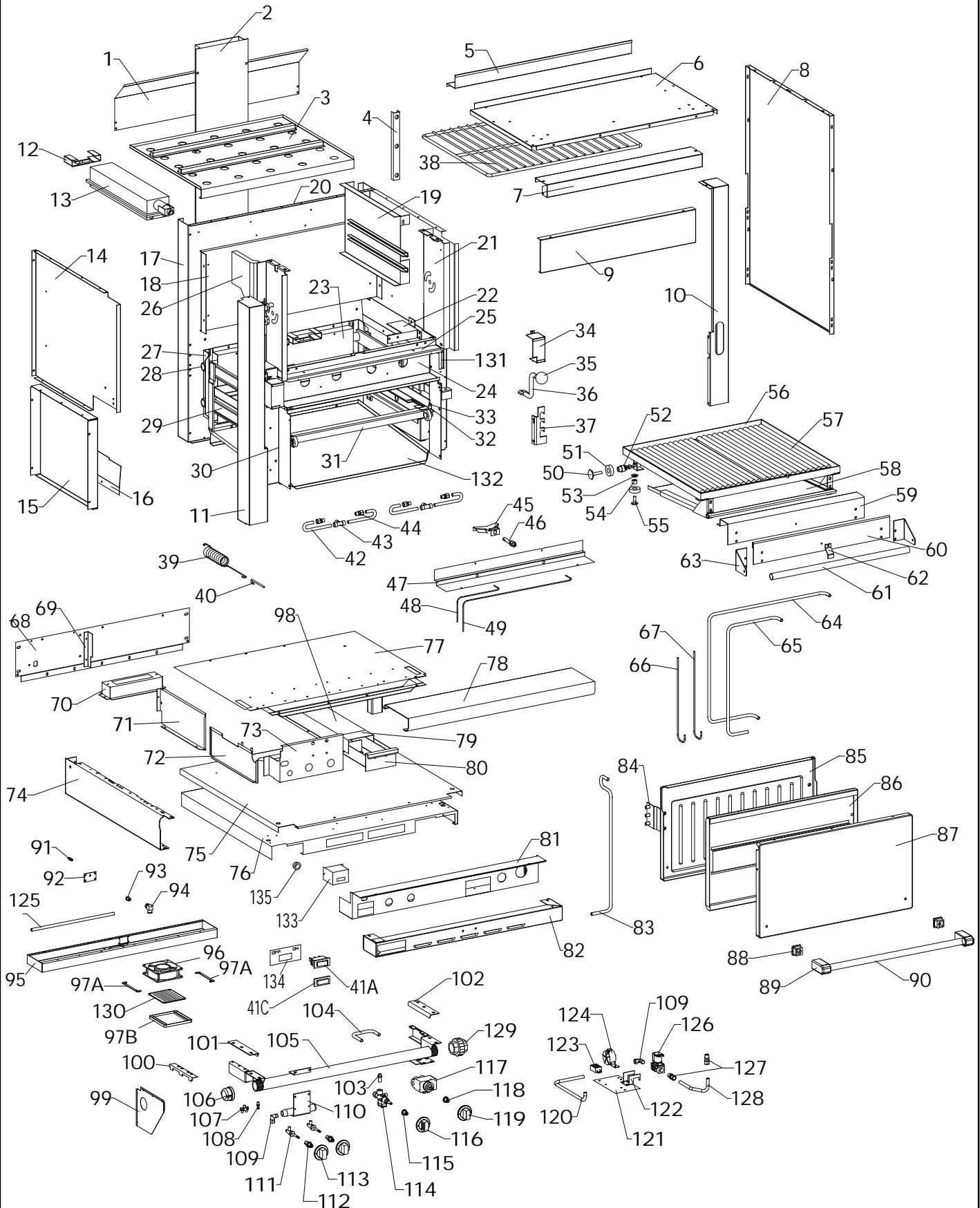

GARLAND PARTS IDENTIFICATION
Master Series Heavy Duty Gas Upright Broiler
models XM100XRM / XM100XRCM / XM100XSM / M100XTM

COMPONENTS

ITEM	PART #	DESCRIPTION	QTY				CRITICAL
			X100XRM	X100XRCM	X100XSM	X100XTM	
1	2676301	Flue Diverter (S/S)	1	1	1	1	
2	1139699	Flue Riser Assy.	1	1			
3	4516307	Upper Oven Bottom Assy.	1	1	1	1	
4	G01260-01-8	Channel Brace Assy.	2	2	2	2	
5	4515517	Flue Shield	1	1	1	1	
6	2666200	Main Top - Std.	1	1	1	1	
	2666201	Main Top - Stainless (Opt.)	1	1	1	1	
7	2668200	Main Front	1	1	1	1	
8	2636000	Main Side - Black	1	1	1	1	
	2636001	Main Side - Stainless	1	1	1	1	
9	4515134	Front Panel	1	1	1	1	
10	4517427	Corner Column R/H	1	1	1	1	
11	4516877	Corner Column Assy. L/H	1	1	1	1	
12	G01994-1-6	Burner Bracket	4	4	4	4	
13	G01229-01	Infra-Red Burner (Specify Gas)	4	4	4	4	
14	4515055	Upper Insulation Lining L/H	1	1	1	1	
	4515056	Upper Insulation Lining R/H	1	1	1	1	
15	4515037	Lower Liner	2	2	2	2	
16	4516045	Inner Deflector L/H	1	1	1	1	
	4516046	Inner Deflector R/H	1	1	1	1	
17	2632200	Main Back	1	1	1	1	
18	4515597	Back Insulation Lining	1	1	1	1	
19	G6344-01-81E	Oven Side Lining Assy. R/H	1	1	1	1	
	G6344-01-82E	Oven Side Lining Assy. L/H	1	1	1	1	
20	2680500	Back Insulation Box	1	1	1	1	
21	G01030-01-81E	Oven Door Support R/H	1	1	1	1	
	G01030-01-82E	Oven Door Support L/H	1	1	1	1	
22	4515046	Front Burner Shield - R/H	1	1	1	1	
	4515048	Front Burner Shield - L/H	1	1	1	1	
23	G01996-1-6	Back Liner	1	1	1	1	
24	4515047	Burner Housing	1	1	1	1	
25	2635700	Front Filler Strip	1	1	1	1	
26	G6007L	Door Counterweight L/H	1	1	1	1	
	G6007R	Door Counterweight R/H	1	1	1	1	
27	G01227-1-8	Carriage Support	2	2	2	2	
28	G01234-01-5	Rack Raising Arm Upper Assy.	1	1	1	1	
29	G01234-02-5	Rack Raising Arm Lower Assy.	1	1	1	1	
30	4515051	Front Frame Side L/H	1	1	1	1	
	4515050	Front Frame Side R/H	1	1	1	1	

* NOT ILLUSTRATED

RECOMMENDED STOCK PARTS

GARLAND PARTS IDENTIFICATION
Master Series Heavy Duty Gas Upright Broiler
models XM100XRM / XM100XRCM / XM100XSM / M100XTM

COMPONENTS

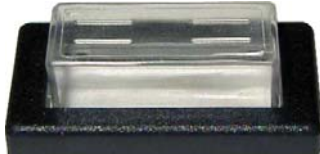
ITEM	PART #	DESCRIPTION	QTY				CRITICAL
			X100XRM	X100XRCM	X100XSM	X100XTM	
31	G02024-01-8	Carriage Assy.	1	1	1	1	
32	G01989-1-8	Post Bearing	2	2	2	2	
33	F5	1/4-20 X 1.25" Hex Socket Screw	2	2	2	2	
34	4516044	Air Deflector R/H	1	1	1	1	
	4516043	Air Deflector L/H	1	1	1	1	
35	1039602	Grey Ball Knob	1	1	1	1	
36	4516744	Rack Lifting Handle Assy.	1	1	1	1	
37	4515577	Broiler Ratchet	1	1	1	1	
38	G6152-40	Oven Rack	1	1	1	1	
39	G01245-1	Broiler Spring	2	2	2	2	
40	G01246-1-8	Spring Hook	2	2	2	2	
41A	2146800	Illuminated Power Switch 	1	1	1	1	
41B*	4520240	Switch Relocation Kit Note: Use this Kit to relocate the illuminated power switch from the corner column of the broiler to the valve panel of the range base for broilers manufactured UP TO serial# 0703100164258 / 28-MAR-2007.	1	1	1	1	
41C	3011400	PVC Clear Cap With Bezel 	1	1	1	1	
42	2655800	7/16 Tubing - Burner Orifice to Tee	4	4	4	4	
43	G01168-1	7/16 Compression Tee	2	2	2	2	
44	G01243-1	Straight Connector - 1/4NPT X 7/16cc	4	4	4	4	
45	4515723	Pilot Shield	2	2	2	2	
46	3093000	Pilot	2	2	2	2	C
47	3093300	Pilot Mounting and Body Enclosure	1	1	1	1	
48	4513669	1/8 Tubing - Left Pilot	1	1	1	1	
49	4513670	1/8 Tubing - Right Pilot	1	1	1	1	
50	G6424	Glider Bolt Hex Head 3/8-16 x 2	2	2	2	2	
51	G01244-1	1 11/16 x 1/2 Large Roller Bearing	6	6	6	6	C
52	G01247-3	Rear Bushing2	2	2	2	2	
53	G01247-1-8	Washer Bearing	2	2	2	2	
54	G01247-2	Front Bearing	2	2	2	2	

* NOT ILLUSTRATED

RECOMMENDED STOCK PARTS

GARLAND PARTS IDENTIFICATION
Master Series Heavy Duty Gas Upright Broiler
models XM100XRM / XM100XRCM / XM100XSM / M100XTM

COMPONENTS



ITEM	PART #	DESCRIPTION	QTY				CRITICAL
			X100XRM	X100XRCM	X100XSM	X100XTM	
55	F56	Hex Head Bolt 5/16-18 x 1	4	4	4	4	
56	2682799	Rack Frame Assy.	1	1	1	1	
57A	4520650	Broiler Rack (Std.)	2	2	2	2	
57B	2684500	Broiler Rack Assy. - Extended (Opt.)	5	5	5	5	
58	2682800	Drip Chute	1	1	1	1	
59	2682200	Broiler Rack Front Veneer (Std.)	1	1	1	1	
60	2682201	Broiler Rack Front Veneer (Opt.Extended Rack.)	1	1	1	1	
61	G01904-03-9	Handle Assy.	1	1	1	1	
62	2682300	Drip Tray Stop	1	1	1	1	
63	2682601	Handle End - L/H	1	1	1	1	
	2682600	Handle End - R/H	1	1	1	1	
64	4517367	7/16" Tubing - Right Valve to Burner	1	1	1	1	
65	4517366	7/16" Tubing - Left Valve to Burner	1	1	1	1	
66	4516047	3/16" Tubing - Left Pilot	1	1	1	1	
67	4516048	3/16" Tubing - Right Pilot	1	1	1	1	
68	4516664	Burner Box Back (Std.)	1		1		
	4516666	Burner Box Back (Rear Gas)	1		1		
	4517119	Burner Box Back (Std.)		1			
	4517120	Burner Box Back (Rear Gas)		1			
	4517374	Burner Box Back (Std.)				1	
	4517375	Burner Box Back (Rear Gas)				1	
69	4516656	Enclosure Bracket	1	1	1	1	
70	1139598	Lower Oven Flue Box	1	1	1	1	
71	4516651	Rear Electrical Cover	1	1	1	1	
72	4516447	Inner Valve Panel Right	1	1	1	1	
73	4520242	Inner Valve Panel	1	1	1	1	
74	1132806	Burner Box Side L/H	1	1	1		
	1132807	Burner Box Side L/H	1	1	1		
	1132804	Burner Box Side R/H	1	1	1		
	1132805	Burner Box Side R/H	1	1	1		
	2247602	Burner Box Side L/H				1	
	2247603	Burner Box Side L/H				1	
	2247600	Burner Box Side R/H				1	
	2247601	Burner Box Side R/H				1	
75	2512600	Burner Box Bottom	1	1	1		
	2247000	Burner Box Bottom				1	
76	2247400	Secondary Burner Box Bottom				1	
77	4515031	Grease Hopper	1	1	1	1	
78	2190699	Front Rail Assy.	1	1	1	1	

* NOT ILLUSTRATED

RECOMMENDED STOCK PARTS

GARLAND PARTS IDENTIFICATION
Master Series Heavy Duty Gas Upright Broiler
models XM100XRM / XM100XRCM / XM100XSM / M100XTM

COMPONENTS

ITEM	PART #	DESCRIPTION	QTY				CRITICAL
			X100XRM	X100XRCM	X100XSM	X100XTM	
79	4517468	Grease Box Front	1	1	1	1	
80	4515573	Grease Drawer Assy.	1	1	1	1	
81	4520241	Valve Panel	1	1	1	1	
81A*	4523510	Valve Panel W/Switch			1	1	
82	2247703	Secondary Valve Panel				1	
83	2230000	7/16 Tubing FD Control to Comp. Union	1	1			
84	G6036-01-8	Door Hinge Assy.	2	2	2	2	
85	1439794	Oven Door Lining Assy.	1	1	1	1	
86	1138399	Broiler Insert Box Assy.	1	1	1	1	
87	1080714	Oven Door Panel	1	1	1	1	
88	3010000	Handle Spacer Insert	2	2	2	2	
89	3007300	Handle End	2	2	2	2	
90	3017000	Door Handle	1	1	1	1	
91	4513619	Hose Barb	1	1	1	1	
92	4515596	Mounting Plate	1	1	1	1	
93	4513620	Reducing Bushing	1	1	1	1	
94	4513621	Plastic Elbow	1	1	1	1	
95	4515035	Plenum	1	1	1	1	
96	4516836	Fan	1	1	1	1	C
97A	4516838	Brackets - Fan Screen 	2	2	2	2	
97B	4516837	Fan Screen 	1	1	1	1	
98	4515103	Grease Box Cover	2	2	2	2	
99	2208001	End Enclosure L/H (Opt.)	1	1	1	1	
100	2208000	End Enclosure R/H (Opt.)	1	1	1	1	
101	2544101	Manifold Bracket Extension L/H	1	1	1	1	
102	2544100	Manifold Bracket Extension R/H	1	1	1	1	
103	2198100	Valve Connector Fitting - 12mm	1	1			
104	2572600	7/16 Tubing - Oven Valve to FD Control	1	1			
105	4515783	Manifold Assy.	1	1	1	1	
	4515935	Manifold Assy. Rear Gas (Opt.)	1	1	1	1	
106	G02335-1	Pipe Cap - 1 1/4"NPT (Opt.)	1	1	1	1	
107	G01248-1	1/4 X 1/4 Double Pilot Valve Assy.	1	1	1	1	
108	G02251-1	Pressure Test Spigot	1	1	1	1	

* NOT ILLUSTRATED

RECOMMENDED STOCK PARTS

GARLAND PARTS IDENTIFICATION
Master Series Heavy Duty Gas Upright Broiler
models XM100XRM / XM100XRCM / XM100XSM / M100XTM

COMPONENTS

ITEM	PART #	DESCRIPTION	QTY				CRITICAL
			X100XRM	X100XRCM	X100XSM	X100XTM	
109	G02352-1	Compression Elbow	2	2	2	2	
110	4516424	Sub-Manifold Assy.	1	1	1	1	
111	1095100	Broiler Valve - Natural Gas Opt.	2	2	2	2	C
	1095101	Broiler Valve - LP Gas Opt.	2	2	2	2	C
112	3043205	Valve Stem Hub	2	2	2	2	
113	3043100	Knob - Broiler	2	2	2	2	C
114	4601583	Sentry/Master Oven Valve	1	1			C
115	3043201	Valve Stem Hub	1	1	1	1	
116	3043101	Knob Oven Valve	1	1	1	1	C
117	G03145-048	FD Control Assy.	1	1			C
118	3043203	Valve Stem Hub	1	1			
119	3043100	Knob - FD Control	1	1			C
120	4516054	7/16" Tube - Solenoid to Manifold	1	1	1	1	
121	4516137	Component Mounting. Plate	1	1	1	1	
122	4516136	Solenoid Mounting Bracket		1	1	1	
123	2573000	Terminal Block	1	1	1	1	
124	3096800	Air Pressure Switch	1	1	1	1	
125	4517380	Flexible PVC Hose	1	1	1	1	
126A	G02965-1	Solenoid Valve		1	1	1	C
126B	4521194	Solenoid Valve w/Bracket	1				C
127	1095499	Straight Connector - 3/8NPT X 7/16cc	2	2	2	2	
128	4516053	7/16" Tube - Manifold to Solenoid	1	1	1	1	
129	G7075	1 1/4" Union	1	1	1	1	
130	4516839	Fan Filter	1	1	1	1	C
							
131	4516987	Cover Plate	2	2	2	2	
132	4517010	Grease Diverter Assembly	1	1	1	1	
133	4520192	Switch Box	1	1	1	1	
134	4512759	Overlay, On / Off - 30x11mm	1	1	1	1	
135	G01487-8	Bushing	1	1	1	1	

* NOT ILLUSTRATED

RECOMMENDED STOCK PARTS

GARLAND PARTS IDENTIFICATION
Master Series Heavy Duty Gas Upright Broiler
models XM100XRM / XM100XRCM / XM100XSM / M100XTM

CRITICAL & RECOMMENDED STOCK PARTS LIST

PART#	DESCRIPTION
1095100	Broiler Valve - Natural Gas Opt.
1095101	Broiler Valve - LP Gas Opt.
4601583	Sentry/Master Oven Valve
3043100	Knob - Broiler
3043100	Knob - FD Control
3043101	Knob Oven Valve
3093000	Pilot
4516136	Solenoid Mounting Bracket
4516836	Fan
4516839	Fan Filter
4521194	Solenoid Valve w/Bracket
G01244-1	1 11/16 x 1/2 Large Roller Bearing
G02965-1	Solenoid Valve
G03145-048	FD Control Assy.

GARLAND PARTS IDENTIFICATION Revision History

REV	PAGE# ⁺⁺	ITEM# ⁺⁺	NOTES	DATE
0			Released Part List	NOV 25/03
1	5	1	"Description changed, also part number 2676300 [Flue Diverter (Opt. with Stainless Back Veneer)] is been removed."	JAN 16/07
	6	57A	Part number changes - was G01544-01-5	
	8	122	Quantity deleted from M100XRM model - was 1	
		126A	Quantity deleted from M100XRM model - was 1	
		126B	New part number added	
2	6	41B	New part number added	JUN 19/07
3	4		New drawing	AUG 10/07
	6	41B, 41C	Part number added	
	7	81	Part number 4517372 (Valve Panel) deleted	
	7		New part number - was Part # 4515483	
	8	133, 134,135	New parts number added	
9		Photo added		
4	7	81A	New part number added	NOV 9/07
	5,6,7,8		Critical parts column added	
5	10	97A, 97B	One single p/n 4516838 was assigned to both the Fan Screen and the Screen Brackets. New p/n - 4516837 is created for the Fan Screen and 4516838 is assigned to the Brackets.	JAN 19/12
	10, 11	97A, 97B, 130	Added photos.	
	4, 5, 12		Added introductory information and critical parts table.	
6	11	114	New FF Valve 4601583. Was 2513399. Direct Replacement. ECO-000437I	JUN 23/16

⁺⁺ Page#/Item# reference the specific page/item numbers in the corresponding Revision version only.



1-844-724-CARE • www.mtwkitchencare.com