



Garland® Induction RTCSmp Module-Line Dual and Quad Cooktops

DUAL-cooktop models

MO DU 7000 360/650/720
MO DU 10000 360/650/720
MO DU 7000 360 FL
MO DU 14000 360/650/720 FL

QUAD-cooktop models

MO QU 14000 650/720
MO QU 20000 650/720
MO QU 21000 720
MO QU 24000 720
MO QU 28000 650/720 FL



PARTS LIST

Parts & Service

T (USA & Canada): 1 800 427 6668

F (USA & Canada): 1 800 361 7745

www.Garland-Group.com

Garland Commercial Ranges, Ltd.
1177 Kamato Road
Mississauga, Ontario L4W 1X4 Canada
www.Garland-Group.com

General Inquiries 1 905 624 0260
USA Sales 1 800 424 2411
Canadian Sales 1 888 442 7526
International Sales, Parts & Service:
www.ManitowocFoodService.com



Rating Plate Location

The rating plate specifies important information such as model number, serial number, and electrical specifications. The rating plate is affixed to the side of the induction generator, next to the mains connection.



Serial Number (S/N) Explained

The serial number for your unit is listed on the rating plate.

Example: MO 321 . 00014 . 1014

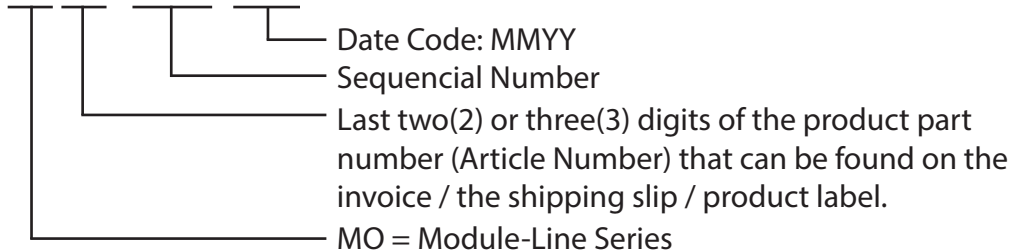

Nomenclature and Models

SERIES	STYLE/ FUNCTION	POWER (WATT)	AVAILABLE GLASS SIZE (MM)	MODELS
MO = module-line	DU = Dual	7000 10000	360 x 360 650 x 375 720 x 360	MO DU 7000 360, MO DU 10000 360 MO DU 7000 650, MO DU 10000 650 MO DU 7000 720, MO DU 10000 720
	DU = Dual Full Coils Only (suffix= FL)	7000 14000	360 x 360 650 x 375 720 x 360	MO DU 7000 360FL MO DU 14000 360FL MO DU 14000 650FL MO DU 14000 720FL
	QU = Quad	14000 20000	650 x 650 720 x 720	MO QU 14000 650, MO QU 20000 650 MO QU 14000 720, MO QU 20000 720
	QU = Quad	21000 24000	720 x 720	MO QU 21000 720 (with both ROUND and FULL coils) MO QU 24000 720 (with both ROUND and FULL coils)
	QU = Quad Full Coil Only (suffix= FL)	28000	650 x 650 720 x 720	MO QU 28000 650FL MO QU 28000 720FL

Users are cautioned that maintenance and repairs must be performed by a Garland authorized service agent using only genuine Garland replacement parts. Garland will have no obligation with respect to any product that has been improperly installed, adjusted, operated or not maintained in accordance with national and local codes and/or installation instructions provided with the product or any product that has its serial number defaced, obliterated or removed, and/or which has been modified or repaired using unauthorized parts or by unauthorized service agents. For a list of authorized service agents and/or genuine replacement parts, please visit our website at www.garland-group.com for USA and Canada. For international customers, please visit www.manitowocfoodservice.com. The information contained herein, including design and part specifications, may be superseded and is subject to change without notice.

Contents

	Rating Plate Location	2
	Serial Number (S/N) Explained	2
	Nomenclature and Models	2
Round Coil Dual Models	MO DU 7000 360	4
	MO DU 7000 650	6
	MO DU 7000 720	8
	MO DU 10000 360	10
	MO DU 10000 650	12
	MO DU 10000 720	14
Round Coil Quad Models	MO QU 14000 650	16
	MO QU 14000 720	18
	MO QU 20000 650	20
	MO QU 20000 720	22
Full Coil Dual Models	MO DU 7000 360FL	24
	MO DU 14000 360FL	26
	MO DU 14000 650FL	28
	MO DU 14000 720FL	30
Full Coil Quad Models	MO QU 28000 650FL	32
	MO QU 28000 720FL	34
Round + Full Coil Quad Models	MO QU 21000 720	36
	MO QU 24000 720	40
	Service Repair Accessories	44
	Critical and Recommended Stock Parts List	45
	Reference Guide: List of Components and Features	46
	Revision History	49

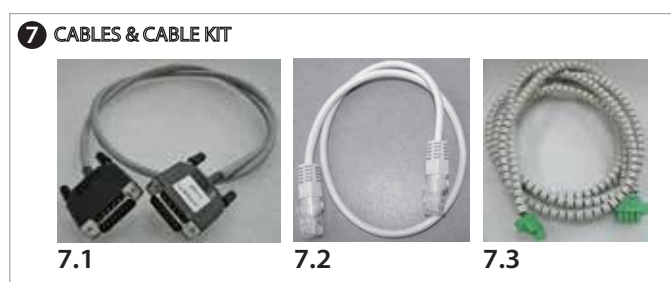
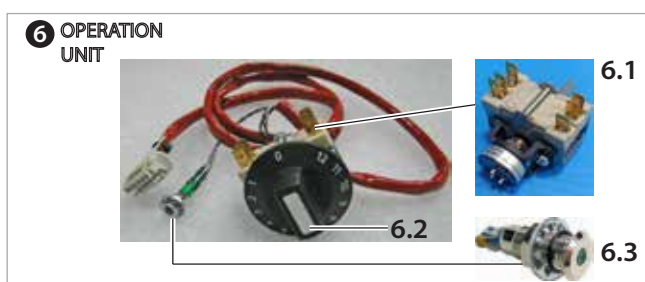
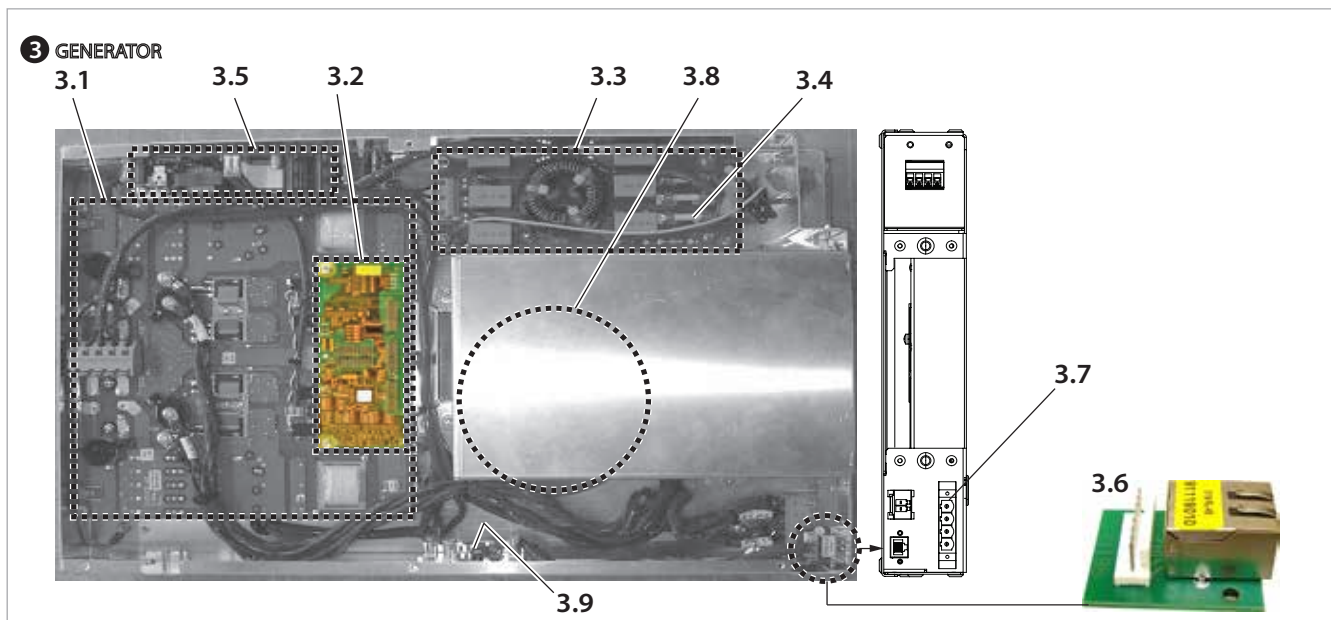
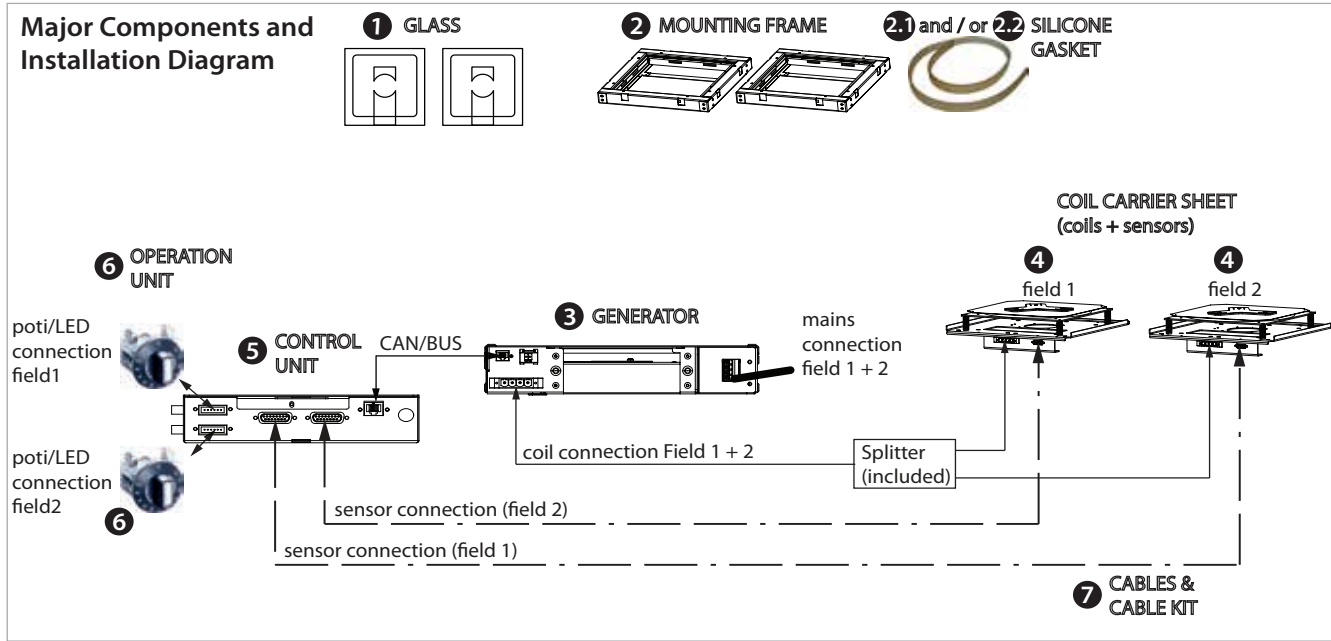

GARLAND PARTS IDENTIFICATION
MO DU 7000 360 208V 7kW 50/60Hz 3Phase 22A
MO DU 7000 360 400V 7kW 50/60Hz 3Phase 10A

ITEM	208V PART#	400V PART#	DESCRIPTION	CRITICAL
1	77363601	77363601	<i>Ceran Glass-Top, Round Coil, 1-Cookzone, 360x 360x 6mm</i>	
2	95000075	95000075	Mounting Frame for 360x 360mm Glass Size, Incl. Silicone Gaskets	
2.1	70000007	70000007	<i>Silicone Gasket, 350x 12x 3mm</i>	
3	99610321	99610320	Generator, Complete Assembly, IN/MO 7000	
3.1	98012661	98012611	<i>Power Module Assembly</i>	C
3.2	91131100	91131120	CPU Board (Print)	
3.3	91168030	91167010	Mains Filter Board (Print)	
3.4	34150259	34150259	<i>Fuse, 25A (Qty=2 per phase)</i>	C
3.5	91120032	91120022	<i>Board (Print) I120</i>	
3.6	91119010	91119010	<i>RJ-45 Board (Print) 119</i>	C
3.7	32060406	32060406	Feed-Through Coupling, 4pol. / 16mm ²	
3.8	94090007	94090007	<i>Axial Fan for IN/MO</i>	C
3.9	91109012	91109012	<i>(Print I109c) Supply and CAN-BUS Interface Board</i>	
4	98100515	98101220	Coil Carrier Sheet, Complete Assembly, 3.5kW Round Coil, 344 x 355 mm	
4.1	94040130	94040130	<i>Sensor Unit, Round Coil, incl. 3xPT Sensors, 1k</i>	C
4.2	93005090	93013081	Induction Coil and Sensor Assembly (with 3xPT Sensors)	
4.3	32060406	32060406	Feed-through Coupling, 4pol / 16mm ²	
4.4	91162011	91162011	<i>(Print I162a) Sub-D, Adapter Board 90deg.</i>	
4.5	60595006	60595006	Screw	
4.6	73000003	73000003	Spring	
4.7	65840003	65840003	Pin	
5	94030221	94030221	<i>Control Unit Assembly, IN/MO 7000/10000, 208V/400V</i>	C
6	94030040	94030040	Operation IN/MO Assembly, 6pol. (Includes items 6.1, 6.2, 6.3, and cable)	C
6.1	94010001	94010001	<i>Potentiometer with Connector, 2pol, cable not included.</i>	C
6.2	39400001	39400001	Plastic Knob, 0-12	
6.3	35624009	35624009	<i>Front Indicator Lamp 24V LED Green, Chrome</i>	
7	95000185	95000180	Cable Kit, Round Coil, IN/MO 7000/10000-360, 2.5-Meter Kit	
	95000186	95000181	Cable Kit, Round Coil, IN/MO 7000/10000-360, 4.0-Meter Kit (Option)	
	95000187	95000182	Cable Kit, Round Coil, IN/MO 7000/10000-360, 6.0-Meter Kit (Option)	
7.1	38601151	38601151	Sensor Cable, D-SUB 15pol., 1-meter	
	38602060	38602080	<i>CAN/BUS RJ-45 Cable, 3-meter / UTP</i>	
7.2	38602061	38602081	<i>CAN/BUS RJ-45 Cable, 5-meter / UTP (Option)</i>	
	38602062		<i>CAN/BUS RJ-45 Cable, 7-meter / UTP (Option)</i>	
7.3	94900269	94900240	Induction Coil Connection Cable, IN/MO, 2.5-meter	
	94900284	94900241	Induction Coil Connection Cable, IN/MO, 4.0-meter (Option)	
	94900285	94900242	Induction Coil Connection Cable, IN/MO, 6.0-meter (Option)	

RECOMMENDED STOCK PARTS

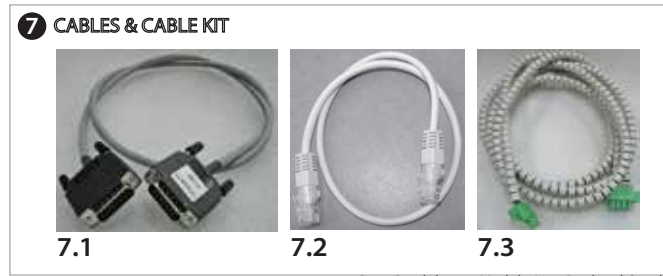
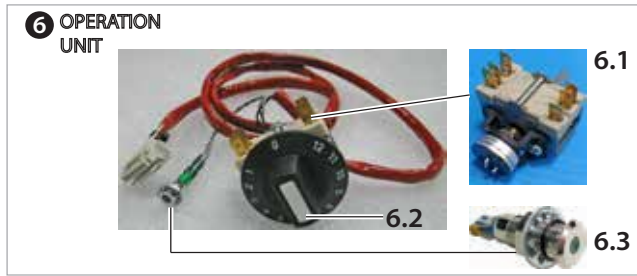
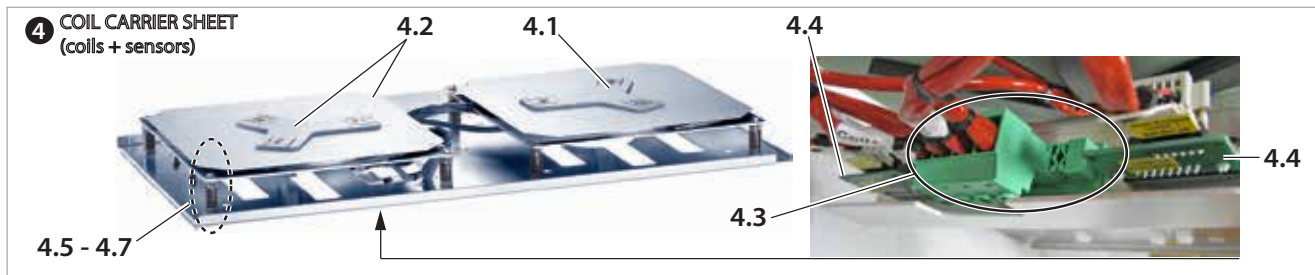
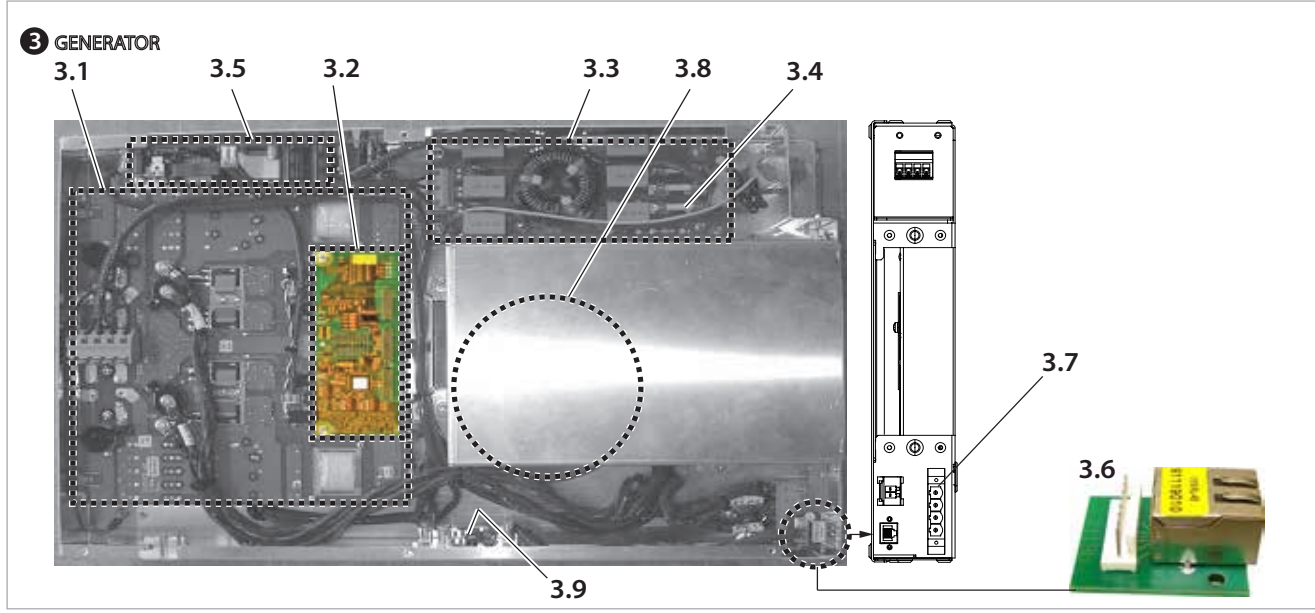
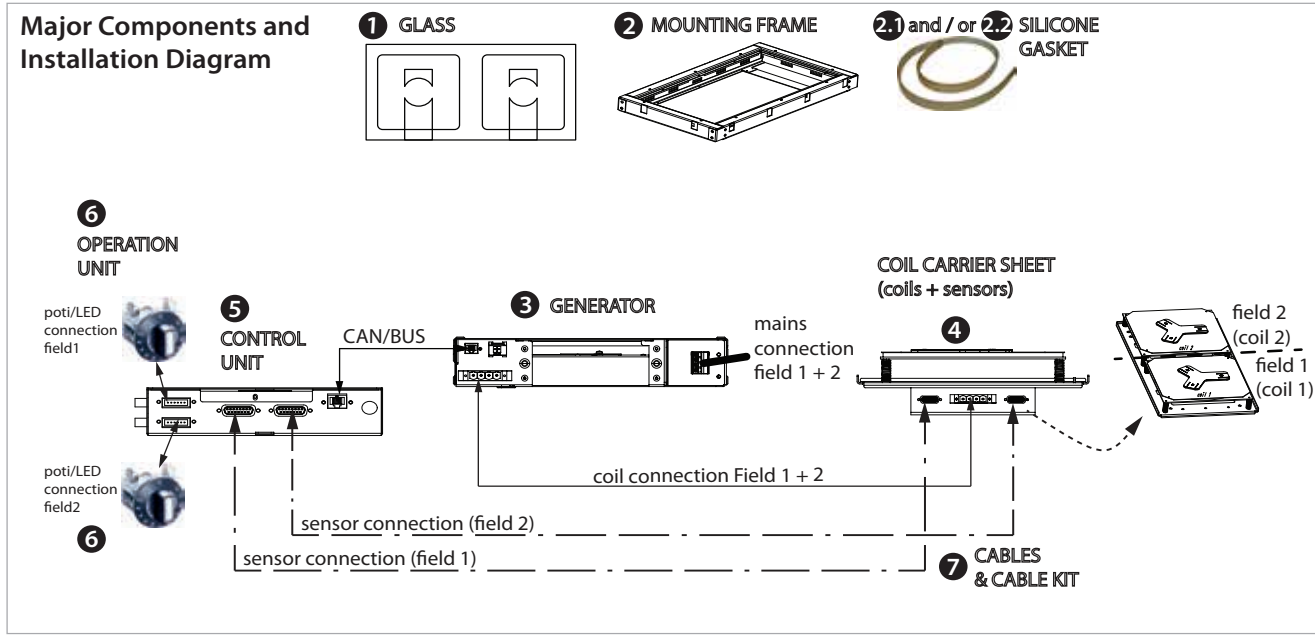

GARLAND PARTS IDENTIFICATION
MO DU 7000 650 208V 7kW 50/60Hz 3Phase 22A
MO DU 7000 650 400V 7kW 50/60Hz 3Phase 10A

ITEM	208V PART#	400V PART#	DESCRIPTION	CRITICAL
1	77376501	77376501	Ceran Glass-Top, Round Coil, 2-Cookzone, 375x 650x 6mm	
2	95000076	95000076	Mounting Frame for 375x 650mm Glass Size, Incl. Silicone Gaskets	
2.1	70000007	70000007	Silicone Gasket, 350x 12x 3mm	
2.2	70000008	70000008	Silicone Gasket, 710x 12x 3mm	
3	99610321	99610320	Generator, Complete Assembly, IN/MO 7000	
3.1	98012661	98012611	Power Module Assembly	C
3.2	91131100	91131120	CPU Board (Print)	
3.3	91168030	91167010	Mains Filter Board (Print)	
3.4	34150259	34150259	Fuse, 25A (Qty=2 per phase)	C
3.5	91120032	91120022	Board (Print) I120	
3.6	91119010	91119010	RJ-45 Board (Print) 119	C
3.7	32060406	32060406	Feed-Through Coupling, 4pol. / 16mm ²	
3.8	94090007	94090007	Axial Fan for IN/MO	C
3.9	91109012	91109012	(Print I109c) Supply and CAN-BUS Interface Board	
4	98100517	98101219	Coil Carrier Sheet, Complete Assembly, 3.5kW Round Coil, 319 x 624 mm	
4.1	94040130	94040130	Sensor Unit, Round Coil, incl. 3xPT Sensors, 1k	C
4.2	93005090	93013081	Induction Coil and Sensor Assembly (with 3xPT Sensors)	
4.3	32060406	32060406	Feed-through Coupling, 4pol / 16mm ²	
4.4	91162011	91162011	(Print I162a) Sub-D, Adapter Board 90deg.	
4.5	60595006	60595006	Screw	
4.6	73000003	73000003	Spring	
4.7	65840003	65840003	Pin	
5	94030221	94030221	Control Unit Assembly, IN/MO 7000/10000, 208V/400V	C
6	94030040	94030040	Operation IN/MO Assembly, 6pol. (Includes items 6.1, 6.2, 6.3, and cable)	C
6.1	94010001	94010001	Potentiometer with Connector, 2pol, cable not included.	C
6.2	39400001	39400001	Plastic Knob, 0-12	
6.3	35624009	35624009	Front Indicator Lamp 24V LED Green, Chrome	
7	95000240	95000191	Cable Kit, Round Coil, IN/MO 7000/10000, 2.5-Meter Kit	
	95000241	95000192	Cable Kit, Round Coil, IN/MO 7000/10000, 4.0-Meter Kit (Option)	
	95000242	95000197	Cable Kit, Round Coil, IN/MO 7000/10000, 6.0-Meter Kit (Option)	
7.1	38601151	38601151	Sensor Cable, D-SUB 15pol., 1-meter	
	38602060	38602080	CAN/BUS RJ-45 Cable, 3-meter / UTP	
7.2	38602061	38602081	CAN/BUS RJ-45 Cable, 5-meter / UTP (Option)	
	38602062		CAN/BUS RJ-45 Cable, 7-meter / UTP (Option)	
	94900269	94900240	Induction Coil Connection Cable, IN/MO, 2.5-meter	
7.3	94900284	94900241	Induction Coil Connection Cable, IN/MO, 4.0-meter (Option)	
	94900285	94900242	Induction Coil Connection Cable, IN/MO, 6.0-meter (Option)	

RECOMMENDED STOCK PARTS

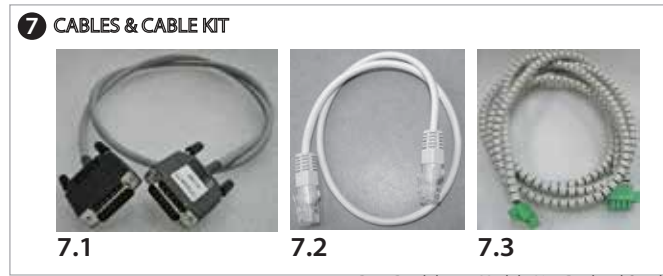
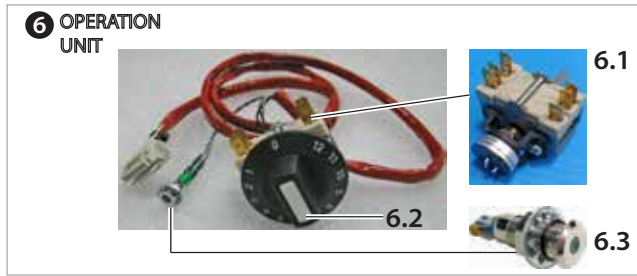
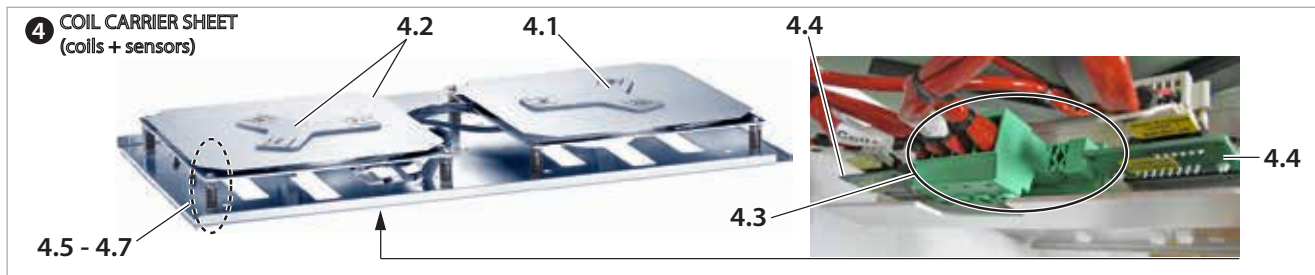
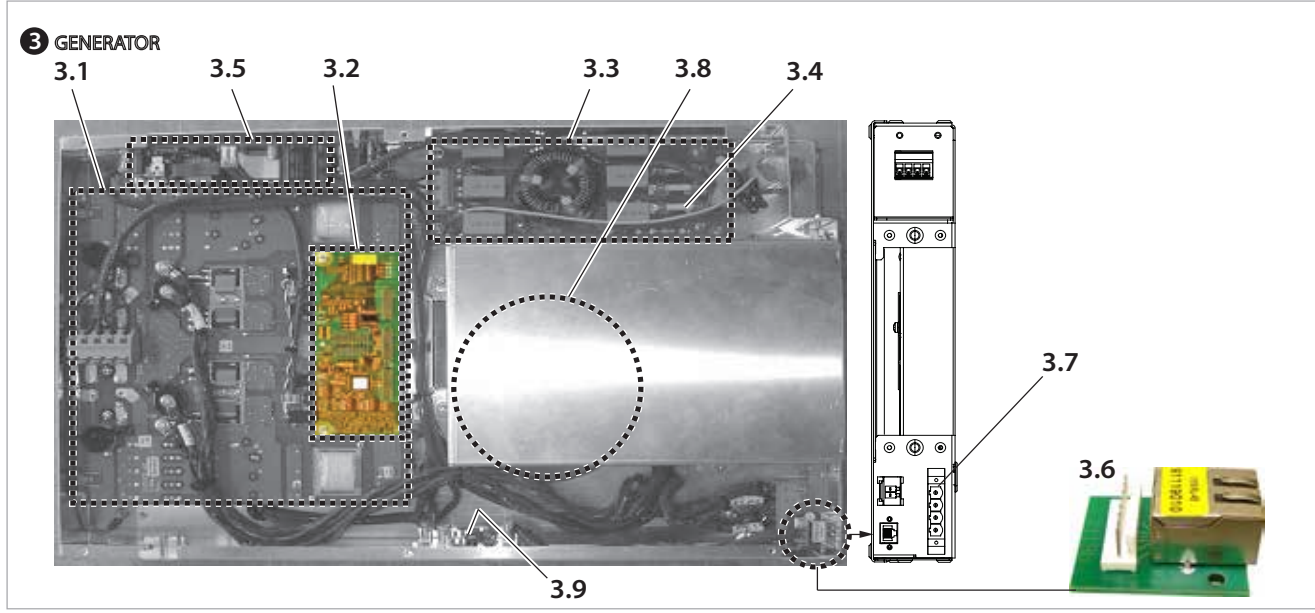
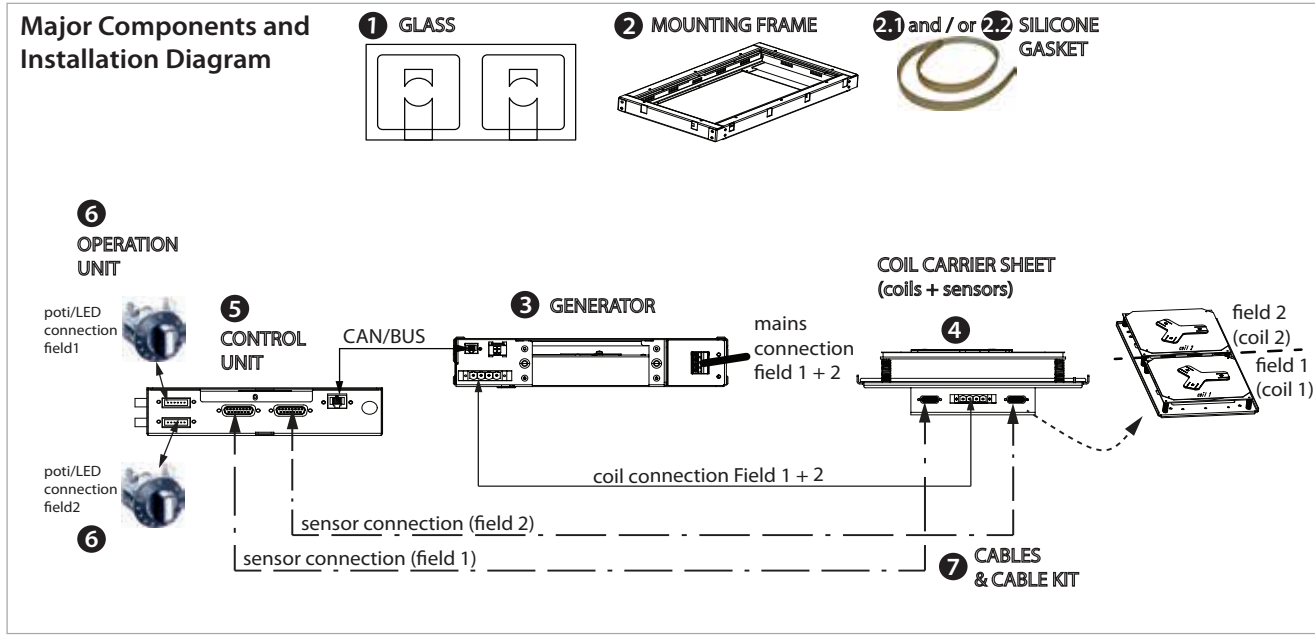

GARLAND PARTS IDENTIFICATION
MO DU 7000 720 208V 7kW 50/60Hz 3Phase 22A
MO DU 7000 720 400V 7kW 50/60Hz 3Phase 10A

ITEM	208V PART#	400V PART#	DESCRIPTION	CRITICAL
1	77367201	77367201	Ceran Glass-Top, Round Coil, 2-Cookzone, 360x 720x 6mm	
2	95000078	95000078	Mounting Frame for 360x 720mm Glass Size, Incl. Silicone Gaskets	
2.1	70000007	70000007	Silicone Gasket, 350x 12x 3mm	
2.2	70000008	70000008	Silicone Gasket, 710x 12x 3mm	
3	99610321	99610320	Generator, Complete Assembly, IN/MO 7000	
3.1	98012661	98012611	Power Module Assembly	C
3.2	91131100	91131120	CPU Board (Print)	
3.3	91168030	91167010	Mains Filter Board (Print)	
3.4	34150259	34150259	Fuse, 25A (Qty=2 per phase)	C
3.5	91120032	91120022	Board (Print) I120	
3.6	91119010	91119010	RJ-45 Board (Print) 119	C
3.7	32060406	32060406	Feed-Through Coupling, 4pol. / 16mm ²	
3.8	94090007	94090007	Axial Fan for IN/MO	C
3.9	91109012	91109012	(Print I109c) Supply and CAN-BUS Interface Board	
4	98100513	98101218	Coil Carrier Sheet, Complete Assembly, 3.5kW Round Coil, 354.5 x 689 mm	
4.1	94040130	94040130	Sensor Unit, Round Coil, incl. 3xPT Sensors, 1k	C
4.2	93005090	93013081	Induction Coil and Sensor Assembly (with 3xPT Sensors)	
4.3	32060406	32060406	Feed-through Coupling, 4pol / 16mm ²	
4.4	91162011	91162011	(Print I162a) Sub-D, Adapter Board 90deg.	
4.5	60595006	60595006	Screw	
4.6	73000003	73000003	Spring	
4.7	65840003	65840003	Pin	
5	94030240	94030240	Control Unit Assembly, IN/MO 7000/14000, 208V/400V	C
6	94030040	94030040	Operation IN/MO Assembly, 6pol. (Includes items 6.1, 6.2, 6.3, and cable)	C
6.1	94010001	94010001	Potentiometer with Connector, 2pol, cable not included.	C
6.2	39400001	39400001	Plastic Knob, 0-12	
6.3	35624009	35624009	Front Indicator Lamp 24V LED Green, Chrome	
7	95000240	95000191	Cable Kit, Round Coil, IN/MO 7000/10000, 2.5-Meter Kit	
	95000241	95000192	Cable Kit, Round Coil, IN/MO 7000/10000, 4.0-Meter Kit (Option)	
	95000242	95000197	Cable Kit, Round Coil, IN/MO 7000/10000, 6.0-Meter Kit (Option)	
7.1	38601151	38601151	Sensor Cable, D-SUB 15pol., 1-meter	
	38602060	38602080	CAN/BUS RJ-45 Cable, 3-meter / UTP	
7.2	38602061	38602081	CAN/BUS RJ-45 Cable, 5-meter / UTP (Option)	
	38602062		CAN/BUS RJ-45 Cable, 7-meter / UTP (Option)	
	94900269	94900240	Induction Coil Connection Cable, IN/MO, 2.5-meter	
7.3	94900284	94900241	Induction Coil Connection Cable, IN/MO, 4.0-meter (Option)	
	94900285	94900242	Induction Coil Connection Cable, IN/MO, 6.0-meter (Option)	

RECOMMENDED STOCK PARTS

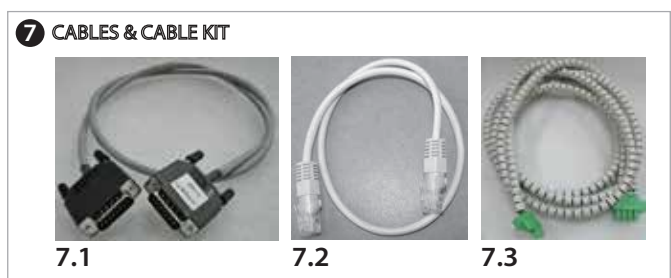
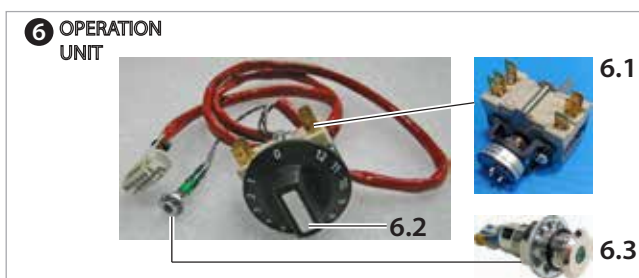
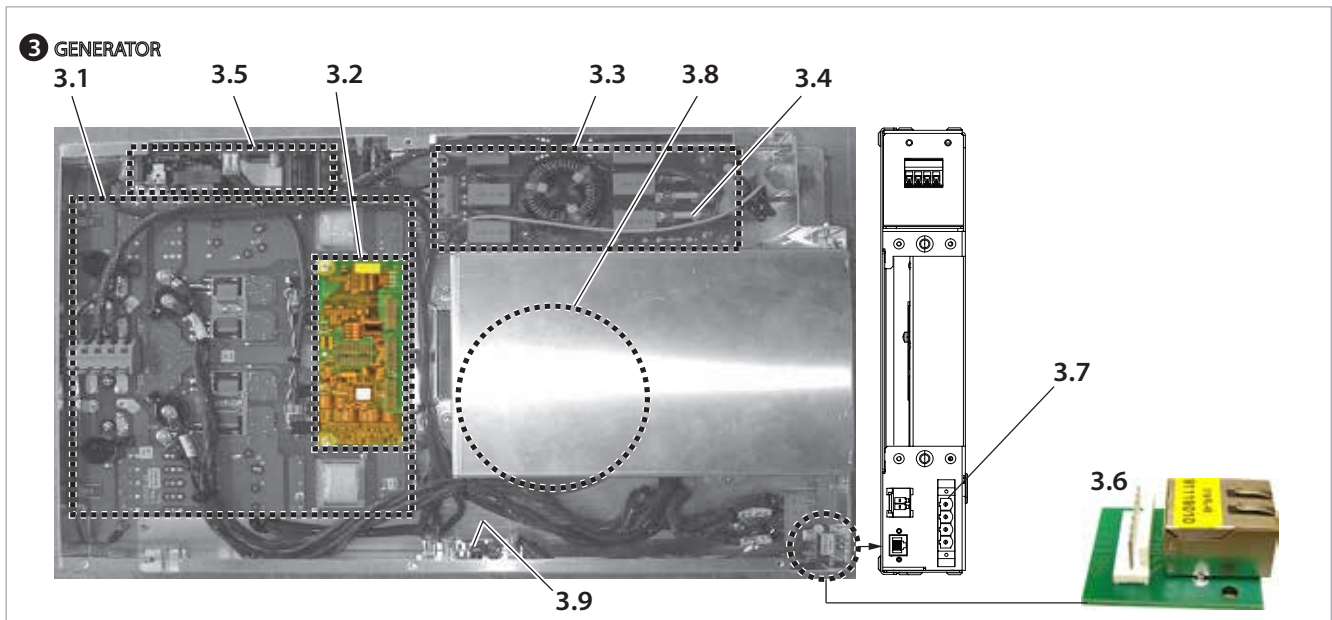
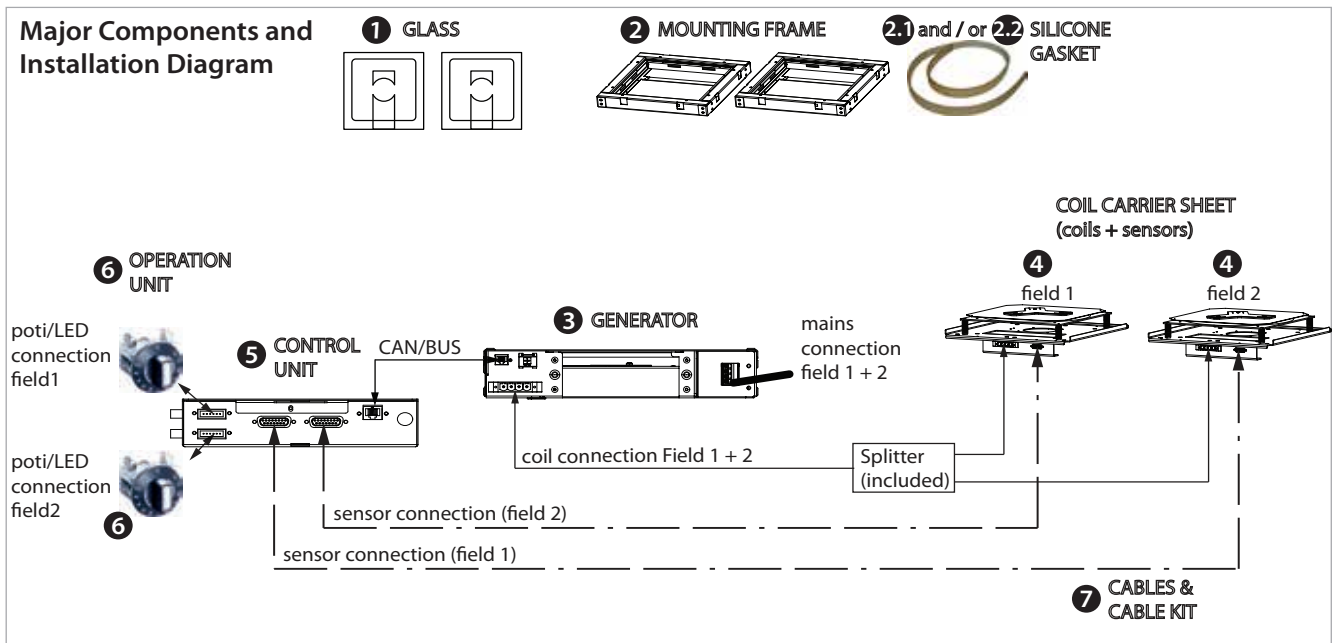

Parts Breakdown - Module-Line Dual and Quad

GARLAND PARTS IDENTIFICATION
MO DU 10000 360 208V 10kW 50/60Hz 3Phase 30A
MO DU 10000 360 400V 10kW 50/60Hz 3Phase 15A

ITEM	208V PART#	400V PART#	DESCRIPTION	CRITICAL
1	77363601	77363601	<i>Ceran Glass-Top, Round Coil, 1-Cookzone, 360x 360x 6mm</i>	
2	95000075	95000075	Mounting Frame for 360x 360mm Glass Size, Incl. Silicone Gaskets	
2.1	70000007	70000007	<i>Silicone Gasket, 350x 12x 3mm</i>	
3	99610331	99610330	Generator, Complete Assembly, IN/MO 10000	
3.1	98012661	98012611	<i>Power Module Assembly</i>	C
3.2	91131140	91131160	CPU Board (Print)	
3.3	91168030	91167010	Mains Filter Board (Print)	
3.4	34150259	34150259	<i>Fuse, 25A (Qty=2 per phase)</i>	C
3.5	91120032	91120022	<i>Board (Print) I120</i>	
3.6	91119010	91119010	<i>RJ-45 Board (Print) 119</i>	C
3.7	32060406	32060406	Feed-Through Coupling, 4pol. / 16mm ²	
3.8	94090007	94090007	<i>Axial Fan for IN/MO</i>	C
3.9	91109012	91109012	<i>Board (Print) I109c Supply and CAN Interface</i>	
4	98100516	98101323	Coil Carrier Sheet, Complete Assembly, 5.0kW Round Coil, 344 x 355 mm	
4.1	94040130	94040130	<i>Sensor Unit, Round Coil, incl. 3xPT Sensors, 1k</i>	C
4.2	93005090	93013081	Induction Coil and Sensor Assembly (with 3xPT Sensors)	
4.3	32060406	32060406	Feed-through Coupling, 4pol / 16mm ²	
4.4	91162011	91162011	<i>(Print I162a) Sub-D, Adapter Board 90deg.</i>	
4.5	60595006	60595006	Screw	
4.6	73000003	73000003	Spring	
4.7	65840003	65840003	Pin	
5	94030221	94030221	<i>Control Unit Assembly, IN/MO 7000/10000, 208V/400V</i>	C
6	94030040	94030040	Operation IN/MO Assembly, 6pol. (Includes items 6.1, 6.2, 6.3, and cable)	C
6.1	94010001	94010001	<i>Potentiometer with Connector, 2pol, cable not included.</i>	C
6.2	39400001	39400001	Plastic Knob, 0-12	
6.3	35624009	35624009	<i>Front Indicator Lamp 24V LED Green, Chrome</i>	
7	95000185	95000180	Cable Kit, Round Coil, IN/MO 7000/10000-360, 2.5-Meter Kit	
	95000186	95000181	Cable Kit, Round Coil, IN/MO 7000/10000-360, 4.0-Meter Kit (Option)	
	95000187	95000182	Cable Kit, Round Coil, IN/MO 7000/10000-360, 6.0-Meter Kit (Option)	
7.1	38601151	38601151	Sensor Cable, D-SUB 15pol., 1-meter	
	38602060	38602080	<i>CAN/BUS RJ-45 Cable, 3-meter / UTP</i>	
7.2	38602061	38602081	<i>CAN/BUS RJ-45 Cable, 5-meter / UTP (Option)</i>	
	38602062		<i>CAN/BUS RJ-45 Cable, 7-meter / UTP (Option)</i>	
	94900269	94900240	Induction Coil Connection Cable, IN/MO, 2.5-meter	
7.3	94900284	94900241	Induction Coil Connection Cable, IN/MO, 4.0-meter (Option)	
	94900285	94900242	Induction Coil Connection Cable, IN/MO, 6.0-meter (Option)	

RECOMMENDED STOCK PARTS

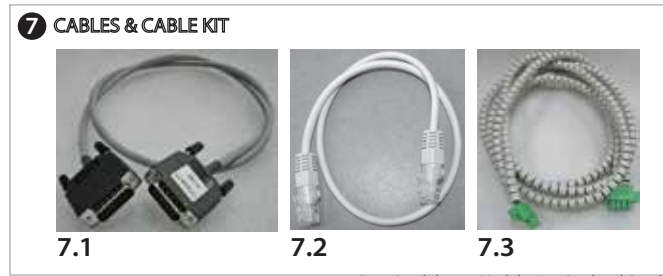
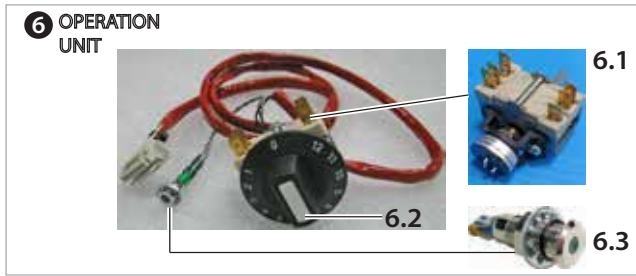
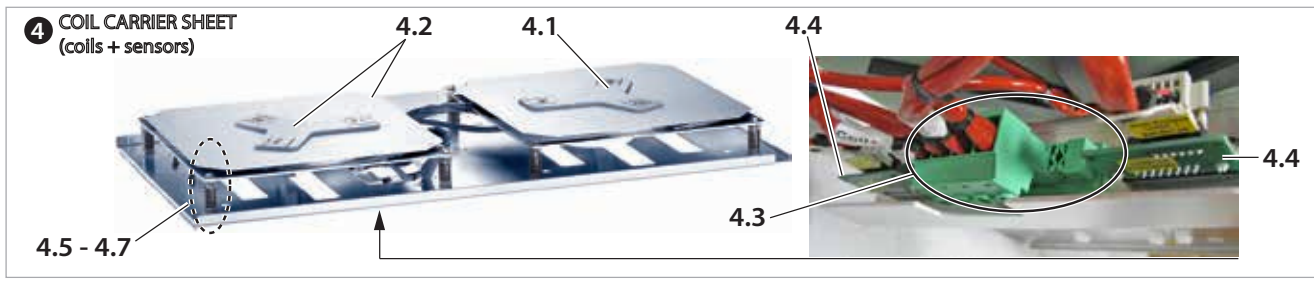
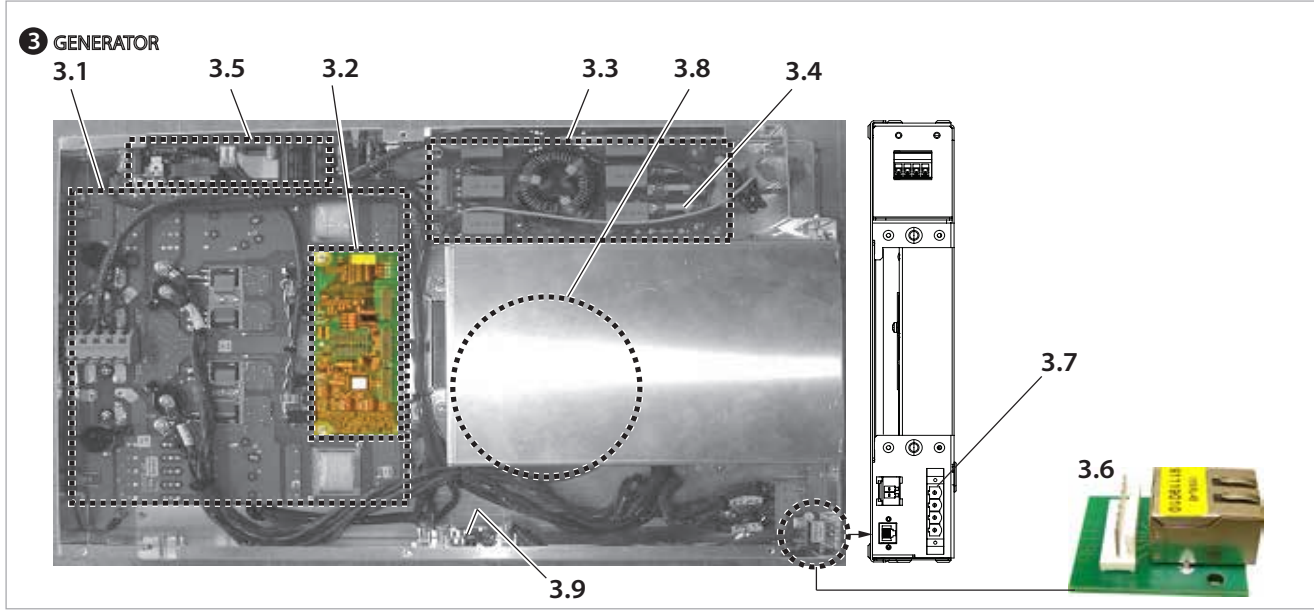
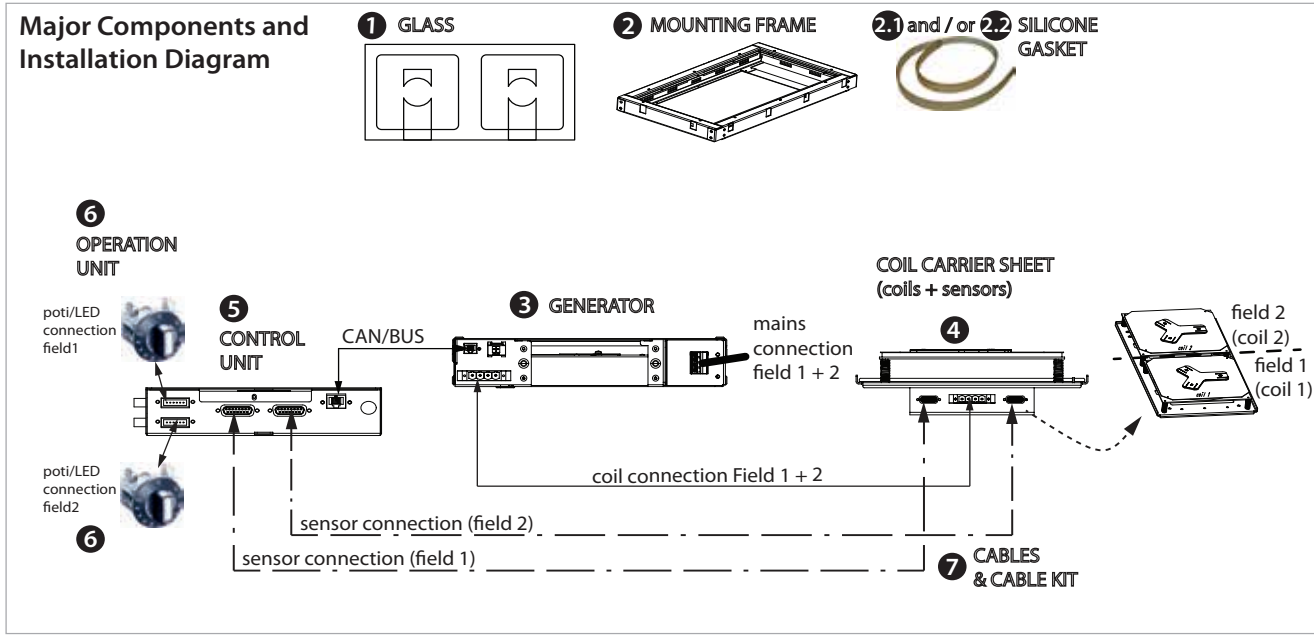

GARLAND PARTS IDENTIFICATION
MO DU 10000 650 208V 10kW 50/60Hz 3Phase 30A
MO DU 10000 650 400V 10kW 50/60Hz 3Phase 15A

ITEM	208V PART#	400V PART#	DESCRIPTION	CRITICAL
1	77376501	77376501	Ceran Glass-Top, Round Coil, 2-Cookzone, 375x 650x 6mm	
2	95000076	95000076	Mounting Frame for 375x 650mm Glass Size, Incl. Silicone Gaskets	
2.1	70000007	70000007	Silicone Gasket, 350x 12x 3mm	
2.2	70000008	70000008	Silicone Gasket, 710x 12x 3mm	
3	99610331	99610330	Generator, Complete Assembly, IN/MO 10000	
3.1	98012661	98012611	Power Module Assembly	C
3.2	91131140	91131160	CPU Board (Print)	
3.3	91168030	91167010	Mains Filter Board (Print)	
3.4	34150259	34150259	Fuse, 25A (Qty=2 per phase)	C
3.5	91120032	91120022	Board (Print) I120	
3.6	91119010	91119010	RJ-45 Board (Print) 119	C
3.7	32060406	32060406	Feed-Through Coupling, 4pol. / 16mm ²	
3.8	94090007	94090007	Axial Fan for IN/MO	C
3.9	91109012	91109012	Board (Print) I109c Supply and CAN Interface	
4	98100518	98101330	Coil Carrier Sheet, Complete Assembly, 5.0kW Round Coil, 319 x 624 mm	
4.1	94040130	94040130	Sensor Unit, Round Coil, incl. 3xPT Sensors, 1k	C
4.2	93005090	93013081	Induction Coil and Sensor Assembly (with 3xPT Sensors)	
4.3	32060406	32060406	Feed-through Coupling, 4pol / 16mm ²	
4.4	91162011	91162011	(Print I162a) Sub-D, Adapter Board 90deg.	
4.5	60595006	60595006	Screw	
4.6	73000003	73000003	Spring	
4.7	65840003	65840003	Pin	
5	94030221	94030221	Control Unit Assembly, IN/MO 7000/10000, 208V/400V	C
6	94030040	94030040	Operation IN/MO Assembly, 6pol. (Includes items 6.1, 6.2, 6.3, and cable)	C
6.1	94010001	94010001	Potentiometer with Connector, 2pol, cable not included.	C
6.2	39400001	39400001	Plastic Knob, 0-12	
6.3	35624009	35624009	Front Indicator Lamp 24V LED Green, Chrome	
7	95000240	95000191	Cable Kit, Round Coil, IN/MO 7000/10000, 2.5-Meter Kit	
	95000241	95000192	Cable Kit, Round Coil, IN/MO 7000/10000, 4.0-Meter Kit (Option)	
	95000242	95000197	Cable Kit, Round Coil, IN/MO 7000/10000, 6.0-Meter Kit (Option)	
7.1	38601151	38601151	Sensor Cable, D-SUB 15pol., 1-meter	
	38602060	38602080	CAN/BUS RJ-45 Cable, 3-meter / UTP	
7.2	38602061	38602081	CAN/BUS RJ-45 Cable, 5-meter / UTP (Option)	
	38602062		CAN/BUS RJ-45 Cable, 7-meter / UTP (Option)	
	94900269	94900240	Induction Coil Connection Cable, IN/MO, 2.5-meter	
7.3	94900284	94900241	Induction Coil Connection Cable, IN/MO, 4.0-meter (Option)	
	94900285	94900242	Induction Coil Connection Cable, IN/MO, 6.0-meter (Option)	

RECOMMENDED STOCK PARTS

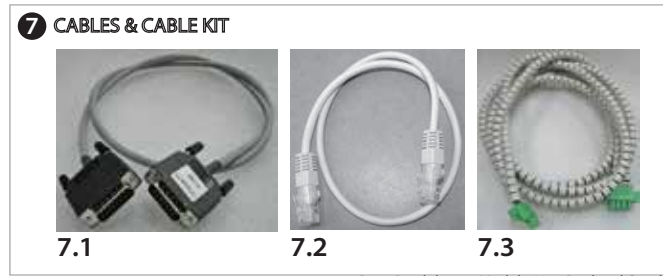
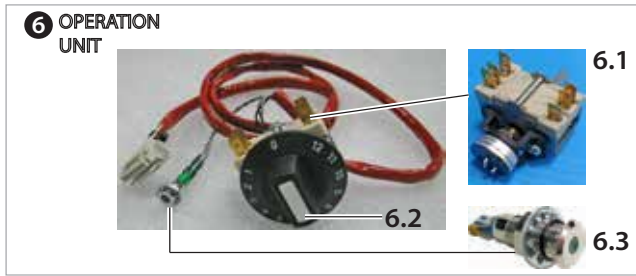
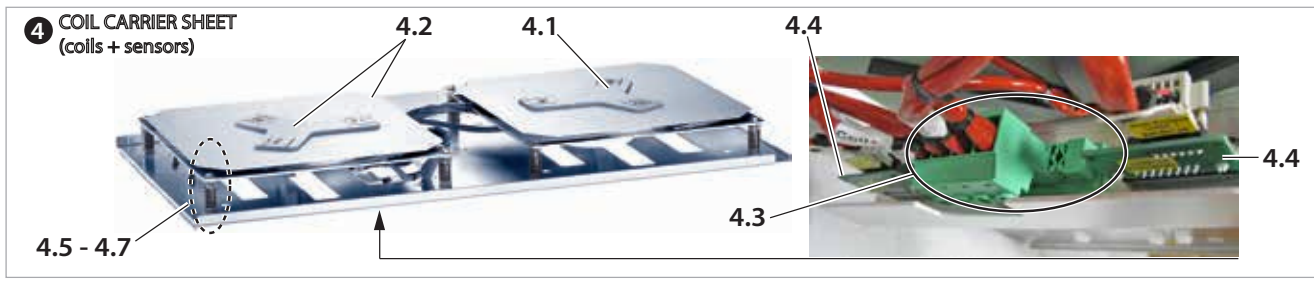
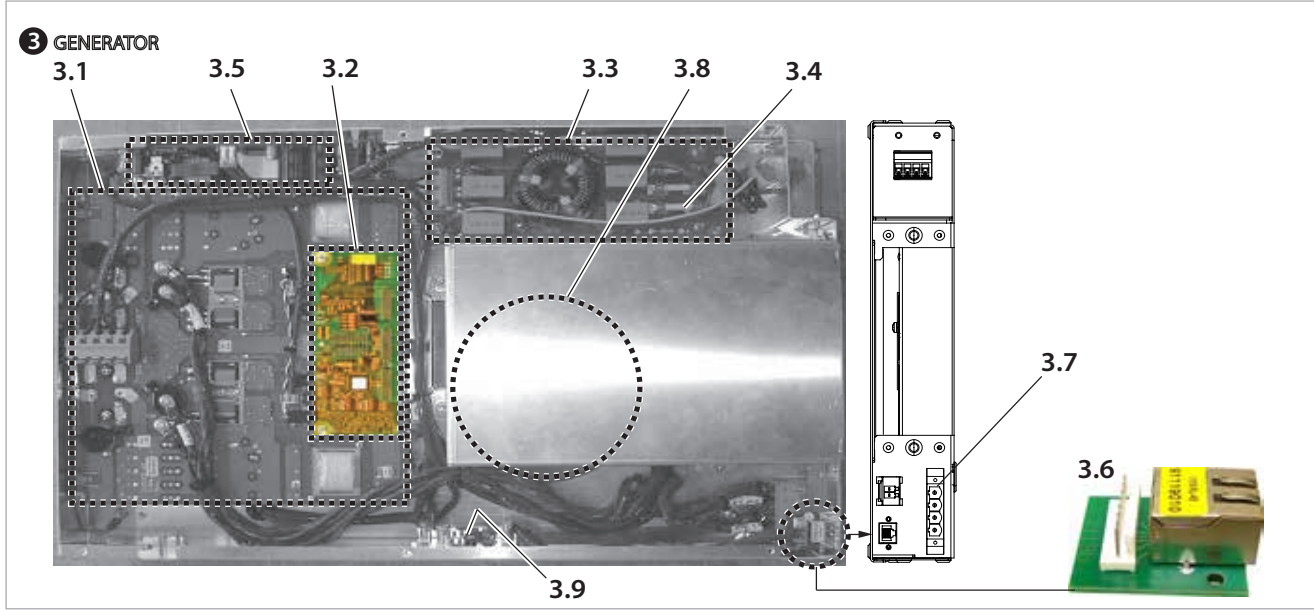
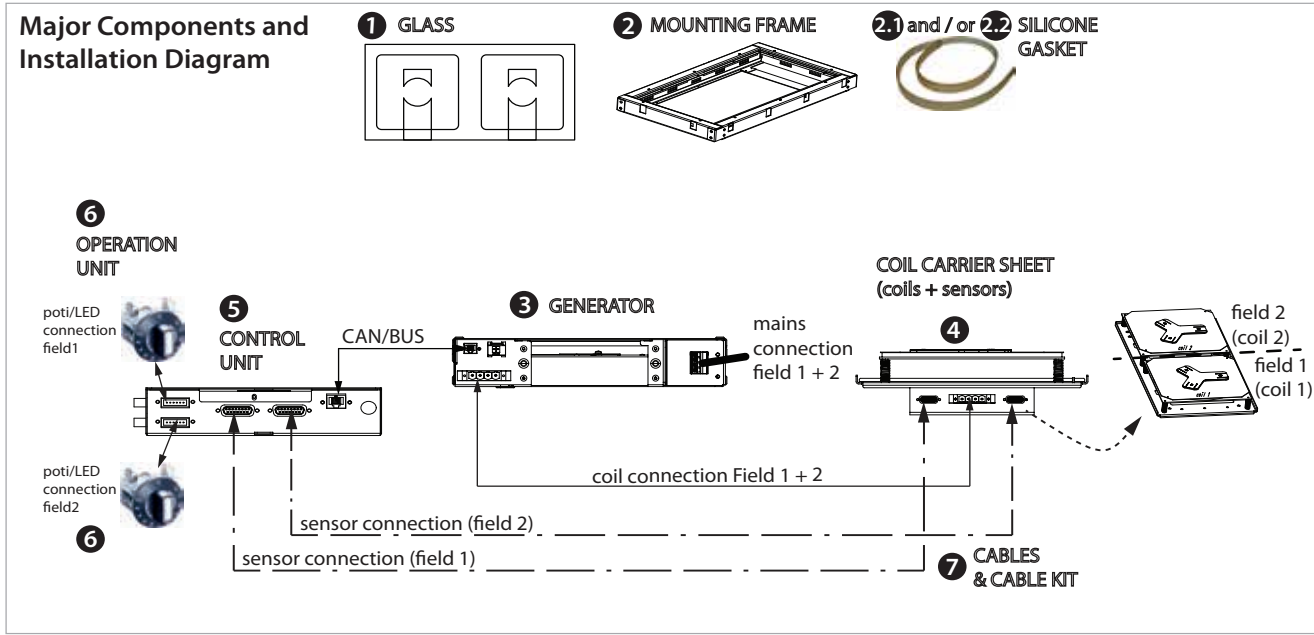

GARLAND PARTS IDENTIFICATION
MO DU 10000 720 208V 10kW 50/60Hz 3Phase 30A
MO DU 10000 720 400V 10kW 50/60Hz 3Phase 15A

ITEM	208V PART#	400V PART#	DESCRIPTION	CRITICAL
1	77367201	77367201	Ceran Glass-Top, Round Coil, 2-Cookzone, 360x 720x 6mm	
2	95000078	95000078	Mounting Frame for 360x 720mm Glass Size, Incl. Silicone Gaskets	
2.1	70000007	70000007	Silicone Gasket, 350x 12x 3mm	
2.2	70000008	70000008	Silicone Gasket, 710x 12x 3mm	
3	99610331	99610330	Generator, Complete Assembly, IN/MO 10000	
3.1	98012661	98012611	Power Module Assembly	C
3.2	91131140	91131160	CPU Board (Print)	
3.3	91168030	91167010	Mains Filter Board (Print)	
3.4	34150259	34150259	Fuse, 25A (Qty=2 per phase)	C
3.5	91120032	91120022	Board (Print) I120	
3.6	91119010	91119010	RJ-45 Board (Print) 119	C
3.7	32060406	32060406	Feed-Through Coupling, 4pol. / 16mm ²	
3.8	94090007	94090007	Axial Fan for IN/MO	C
3.9	91109012	91109012	Board (Print) I109c Supply and CAN Interface	
4	98100514	98101322	Coil Carrier Sheet, Complete Assembly, 5.0kW Round Coil, 354.5 x 689 mm	
4.1	94040130	94040130	Sensor Unit, Round Coil, incl. 3xPT Sensors, 1k	C
4.2	93005090	93013081	Induction Coil and Sensor Assembly (with 3xPT Sensors)	
4.3	32060406	32060406	Feed-through Coupling, 4pol / 16mm ²	
4.4	91162011	91162011	(Print I162a) Sub-D, Adapter Board 90deg.	
4.5	60595006	60595006	Screw	
4.6	73000003	73000003	Spring	
4.7	65840003	65840003	Pin	
5	94030221	94030221	Control Unit Assembly, IN/MO 7000/10000, 208V/400V	C
6	94030040	94030040	Operation IN/MO Assembly, 6pol. (Includes items 6.1, 6.2, 6.3, and cable)	C
6.1	94010001	94010001	Potentiometer with Connector, 2pol, cable not included.	C
6.2	39400001	39400001	Plastic Knob, 0-12	
6.3	35624009	35624009	Front Indicator Lamp 24V LED Green, Chrome	
7	95000240	95000191	Cable Kit, Round Coil, IN/MO 7000/10000, 2.5-Meter Kit	
	95000241	95000192	Cable Kit, Round Coil, IN/MO 7000/10000, 4.0-Meter Kit (Option)	
	95000242	95000197	Cable Kit, Round Coil, IN/MO 7000/10000, 6.0-Meter Kit (Option)	
7.1	38601151	38601151	Sensor Cable, D-SUB 15pol., 1-meter	
7.2	38602060	38602080	CAN/BUS RJ-45 Cable, 3-meter / UTP	
	38602061	38602081	CAN/BUS RJ-45 Cable, 5-meter / UTP (Option)	
	38602062		CAN/BUS RJ-45 Cable, 7-meter / UTP (Option)	
7.3	94900269	94900240	Induction Coil Connection Cable, IN/MO, 2.5-meter	
	94900284	94900241	Induction Coil Connection Cable, IN/MO, 4.0-meter (Option)	
	94900285	94900242	Induction Coil Connection Cable, IN/MO, 6.0-meter (Option)	

RECOMMENDED STOCK PARTS

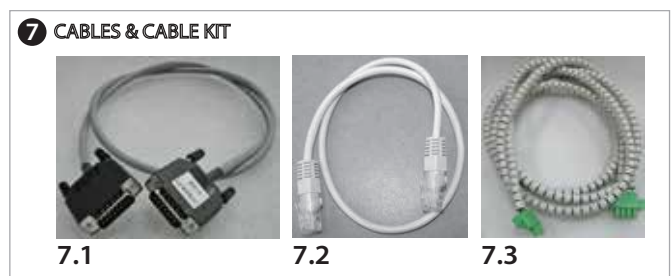
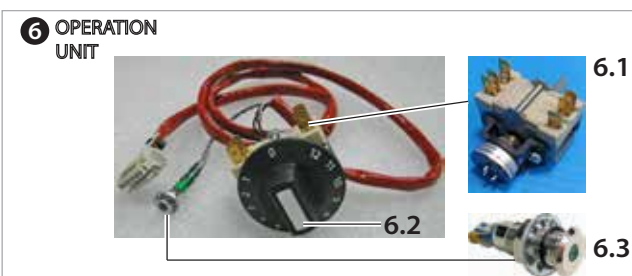
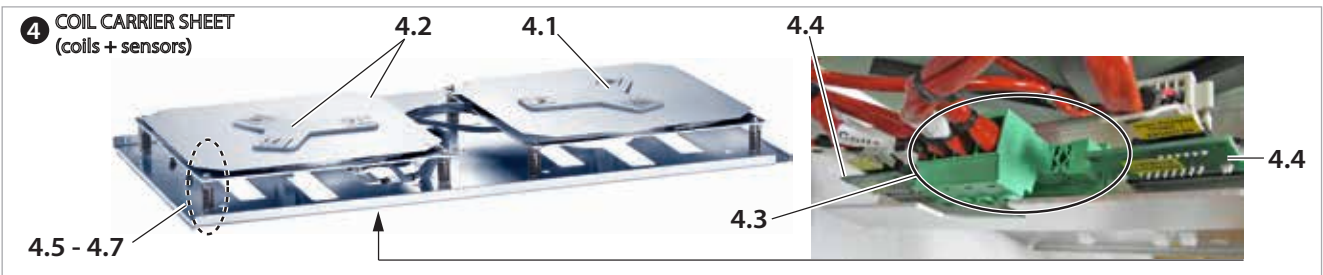
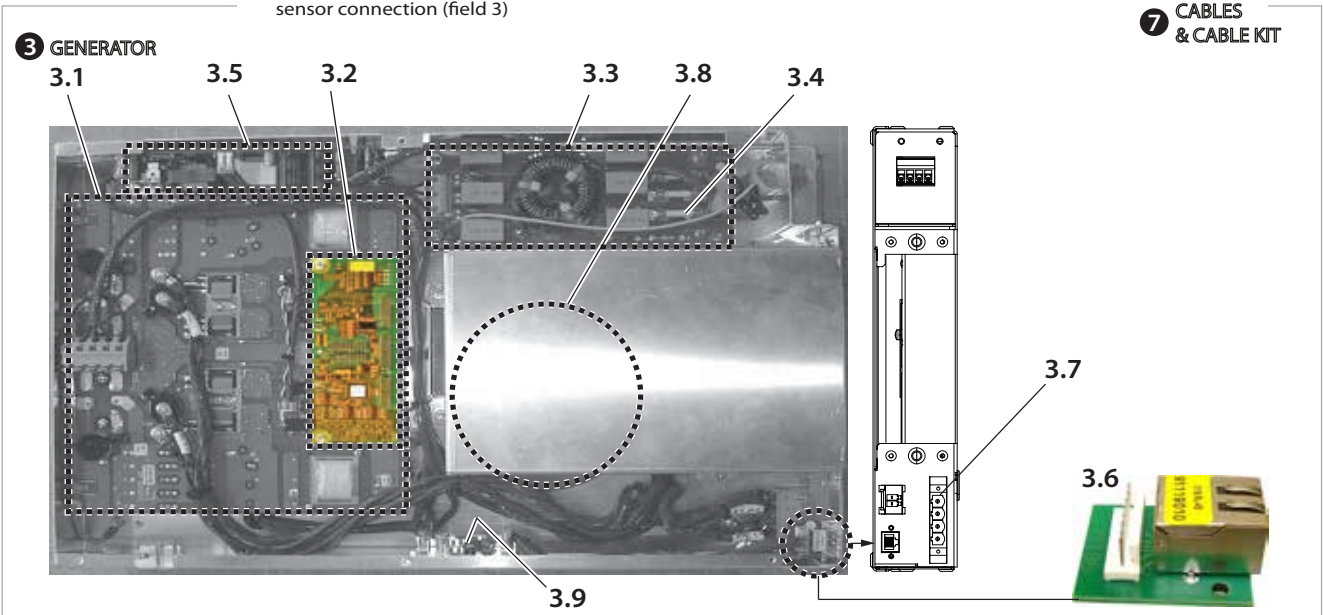
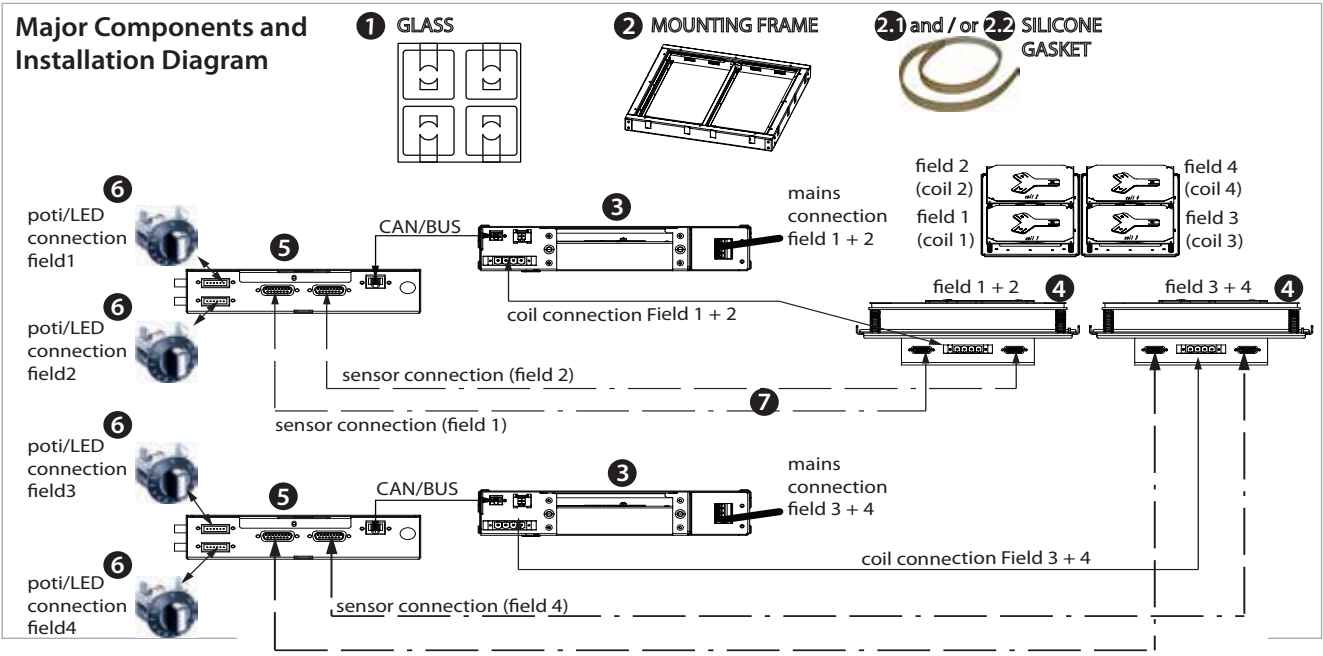

GARLAND PARTS IDENTIFICATION
MO QU 14000 650 208V 2x 7kW 50/60Hz 3Phase 22A
MO QU 14000 650 400V 2x 7kW 50/60Hz 3Phase 15A

ITEM	208V PART#	400V PART#	DESCRIPTION	CRITICAL
1	77656501	77656501	Ceran Glass-Top, Round Coil, 4-Cookzone, 650x 650x 6mm	
2	95000077	95000077	Mounting Frame for 650x 650mm Glass Size, Incl. Silicone Gaskets	
2.2	70000008	70000008	Silicone Gasket, 710x 12x 3mm	
3	99610321	99610320	Generator, Complete Assembly, IN/MO 7000	
3.1	98012661	98012611	Power Module Assembly	C
3.2	91131100	91131120	CPU Board (Print)	
3.3	91168030	91167010	Mains Filter Board (Print)	
3.4	34150259	34150259	Fuse, 25A (Qty=2 per phase)	C
3.5	91120032	91120022	Board (Print) I120	
3.6	91119010	91119010	RJ-45 Board (Print) 119	C
3.7	32060406	32060406	Feed-Through Coupling, 4pol. / 16mm ²	
3.8	94090007	94090007	Axial Fan for IN/MO	C
3.9	91109012	91109012	(Print I109c) Supply and CAN-BUS Interface Board	
4	98100517	98101219	Coil Carrier Sheet, Complete Assembly, 3.5kW Round Coil, 319 x 624 mm	
4.1	94040130	94040130	Sensor Unit, Round Coil, incl. 3xPT Sensors, 1k	C
4.2	93005090	93013081	Induction Coil and Sensor Assembly (with 3xPT Sensors)	
4.3	32060406	32060406	Feed-through Coupling, 4pol / 16mm ²	
4.4	91162011	91162011	(Print I162a) Sub-D, Adapter Board 90deg.	
4.5	60595006	60595006	Screw	
4.6	73000003	73000003	Spring	
4.7	65840003	65840003	Pin	
5	94030221	94030221	Control Unit Assembly, IN/MO 7000/10000, 208V/400V	C
6	94030040	94030040	Operation IN/MO Assembly, 6pol. (Includes items 6.1, 6.2, 6.3, and cable)	C
6.1	94010001	94010001	Potentiometer with Connector, 2pol, cable not included.	C
6.2	39400001	39400001	Plastic Knob, 0-12	
6.3	35624009	35624009	Front Indicator Lamp 24V LED Green, Chrome	
7	95000240	95000191	Cable Kit, Round Coil, IN/MO 7000/10000, 2.5-Meter Kit	
	95000241	95000192	Cable Kit, Round Coil, IN/MO 7000/10000, 4.0-Meter Kit (Option)	
	95000242	95000197	Cable Kit, Round Coil, IN/MO 7000/10000, 6.0-Meter Kit (Option)	
7.1	38601151	38601151	Sensor Cable, D-SUB 15pol., 1-meter	
	38602060	38602080	CAN/BUS RJ-45 Cable, 3-meter / UTP	
7.2	38602061	38602081	CAN/BUS RJ-45 Cable, 5-meter / UTP (Option)	
	38602062		CAN/BUS RJ-45 Cable, 7-meter / UTP (Option)	
	94900269	94900240	Induction Coil Connection Cable, IN/MO, 2.5-meter	
7.3	94900284	94900241	Induction Coil Connection Cable, IN/MO, 4.0-meter (Option)	
	94900285	94900242	Induction Coil Connection Cable, IN/MO, 6.0-meter (Option)	

RECOMMENDED STOCK PARTS

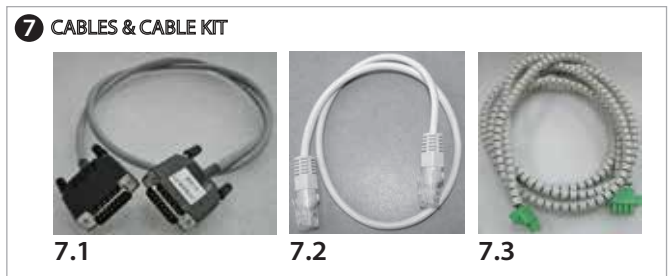
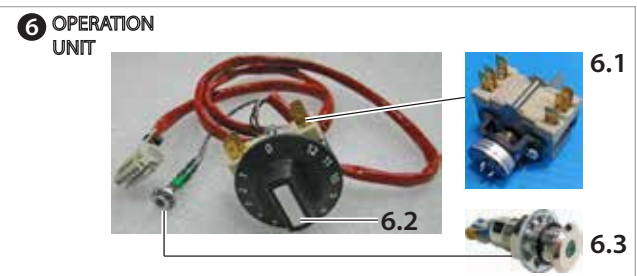
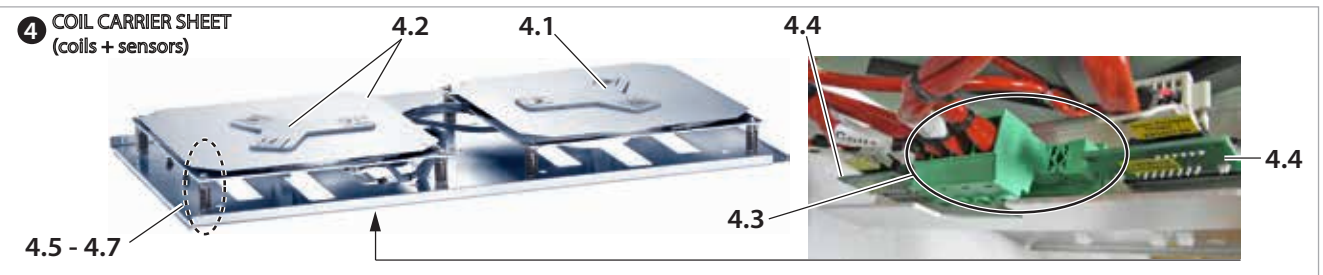
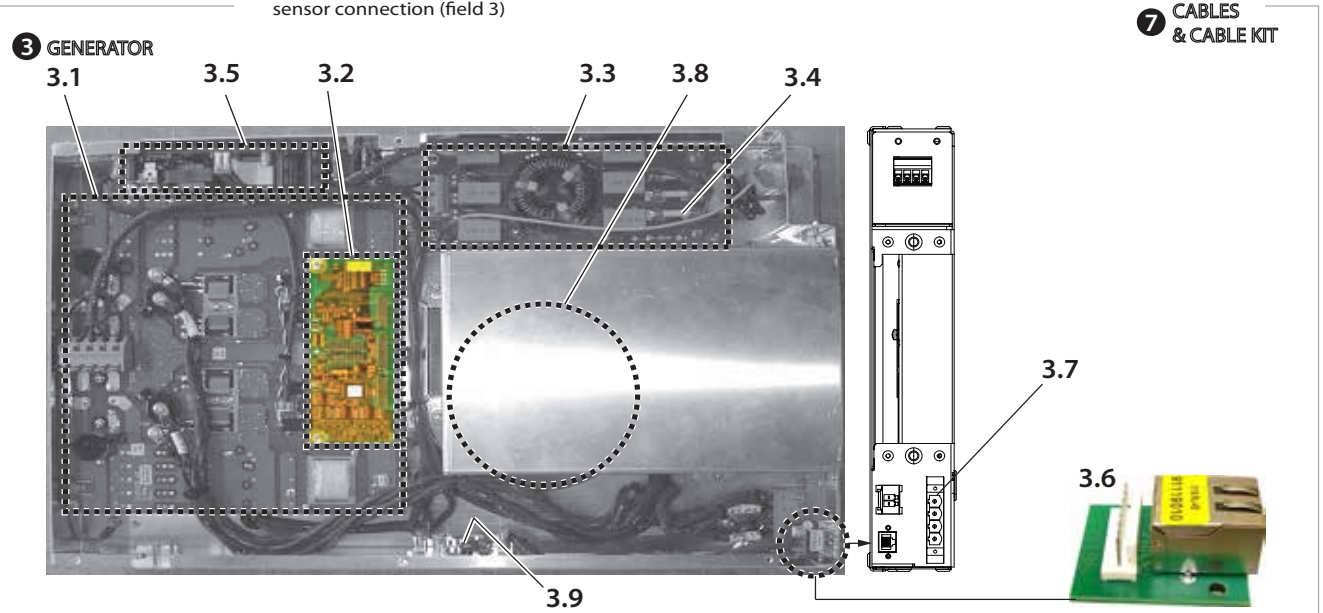
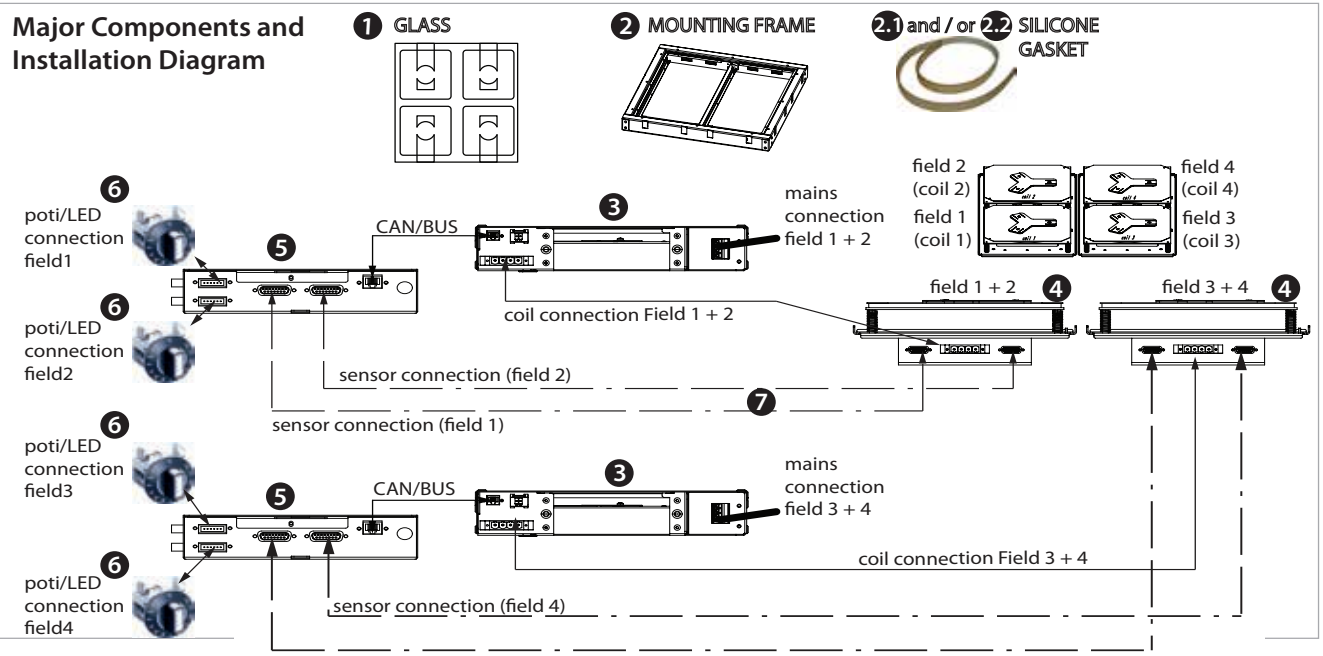

GARLAND PARTS IDENTIFICATION
MO QU 14000 720 208V 2x 7kW 50/60Hz 3Phase 22A
MO QU 14000 720 400V 2x 7kW 50/60Hz 3Phase 10A

ITEM	208V PART#	400V PART#	DESCRIPTION	CRITICAL
1	77727201	77727201	Ceran Glass-Top, Round Coil, 4-Cookzone, 720x 720x 6mm	
2	95000079	95000079	Mounting Frame for 720x 720mm Glass Size, Incl. Silicone Gaskets	
2.2	70000008	70000008	Silicone Gasket, 710x 12x 3mm	
3	99610321	99610320	Generator, Complete Assembly, IN/MO 7000	
3.1	98012661	98012611	Power Module Assembly	C
3.2	91131100	91131120	CPU Board (Print)	
3.3	91168030	91167010	Mains Filter Board (Print)	
3.4	34150259	34150259	Fuse, 25A (Qty=2 per phase)	C
3.5	91120032	91120022	Board (Print) I120	
3.6	91119010	91119010	RJ-45 Board (Print) 119	C
3.7	32060406	32060406	Feed-Through Coupling, 4pol. / 16mm ²	
3.8	94090007	94090007	Axial Fan for IN/MO	C
3.9	91109012	91109012	(Print I109c) Supply and CAN-BUS Interface Board	
4	98100513	98101218	Coil Carrier Sheet, Complete Assembly, 3.5kW Round Coil, 354.5 x 689 mm	
4.1	94040130	94040130	Sensor Unit, Round Coil, incl. 3xPT Sensors, 1k	C
4.2	93005090	93013081	Induction Coil and Sensor Assembly (with 3xPT Sensors)	
4.3	32060406	32060406	Feed-through Coupling, 4pol / 16mm ²	
4.4	91162011	91162011	(Print I162a) Sub-D, Adapter Board 90deg.	
4.5	60595006	60595006	Screw	
4.6	73000003	73000003	Spring	
4.7	65840003	65840003	Pin	
5	94030221	94030221	Control Unit Assembly, IN/MO 7000/10000, 208V/400V	C
6	94030040	94030040	Operation IN/MO Assembly, 6pol. (Includes items 6.1, 6.2, 6.3, and cable)	C
6.1	94010001	94010001	Potentiometer with Connector, 2pol, cable not included.	C
6.2	39400001	39400001	Plastic Knob, 0-12	
6.3	35624009	35624009	Front Indicator Lamp 24V LED Green, Chrome	
7	95000240	95000191	Cable Kit, Round Coil, IN/MO 7000/10000, 2.5-Meter Kit	
	95000241	95000192	Cable Kit, Round Coil, IN/MO 7000/10000, 4.0-Meter Kit (Option)	
	95000242	95000197	Cable Kit, Round Coil, IN/MO 7000/10000, 6.0-Meter Kit (Option)	
7.1	38601151	38601151	Sensor Cable, D-SUB 15pol., 1-meter	
	38602060	38602080	CAN/BUS RJ-45 Cable, 3-meter / UTP	
7.2	38602061	38602081	CAN/BUS RJ-45 Cable, 5-meter / UTP (Option)	
	38602062		CAN/BUS RJ-45 Cable, 7-meter / UTP (Option)	
	94900269	94900240	Induction Coil Connection Cable, IN/MO, 2.5-meter	
7.3	94900284	94900241	Induction Coil Connection Cable, IN/MO, 4.0-meter (Option)	
	94900285	94900242	Induction Coil Connection Cable, IN/MO, 6.0-meter (Option)	

RECOMMENDED STOCK PARTS

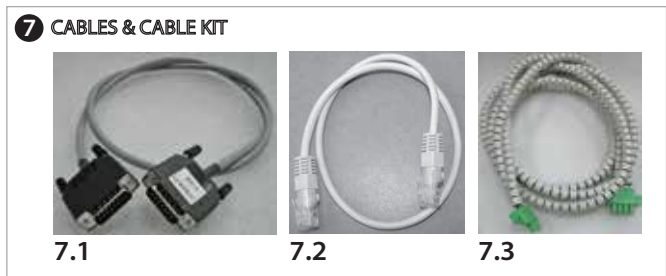
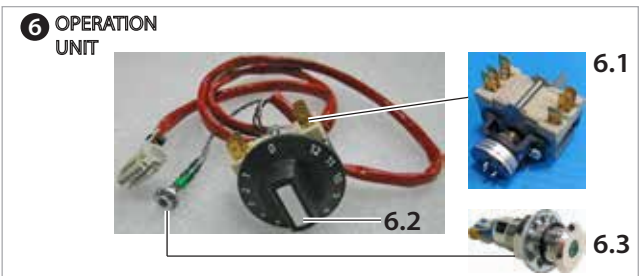
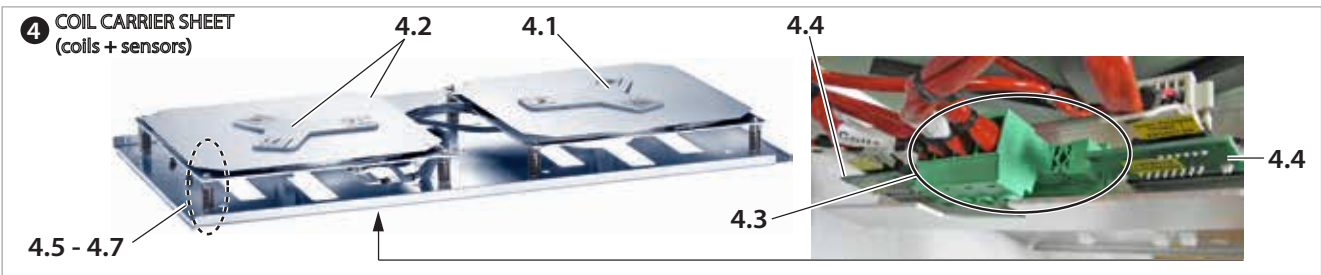
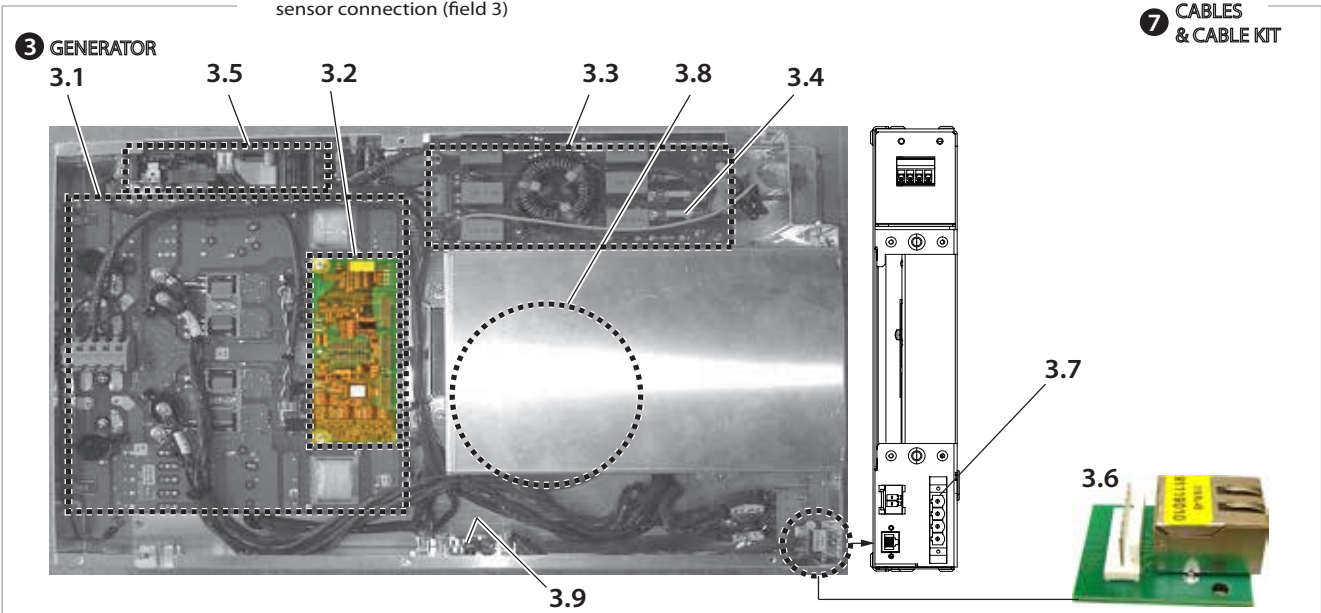
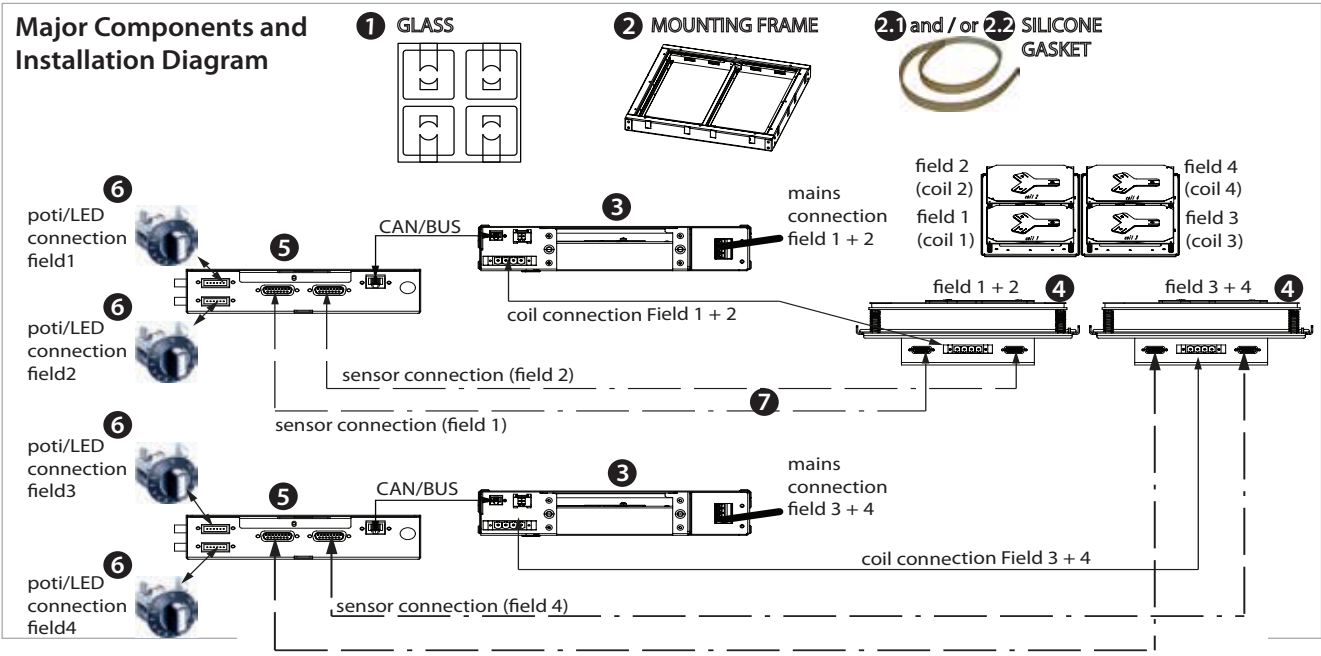

GARLAND PARTS IDENTIFICATION
MO QU 20000 650 208V 2x 10kW 50/60Hz 3Phase 30A
MO QU 20000 650 400V 2x 10kW 50/60Hz 3Phase 15A

ITEM	208V PART#	400V PART#	DESCRIPTION	CRITICAL
1	77656501	77656501	Ceran Glass-Top, Round Coil, 4-Cookzone, 650x 650x 6mm	
2	95000077	95000077	Mounting Frame for 650x 650mm Glass Size, Incl. Silicone Gaskets	
2.2	70000008	70000008	Silicone Gasket, 710x 12x 3mm	
3	99610331	99610330	Generator, Complete Assembly, IN/MO 10000	
3.1	98012661	98012611	Power Module Assembly	C
3.2	91131140	91131160	CPU Board (Print)	
3.3	91168030	91167010	Mains Filter Board (Print)	
3.4	34150259	34150259	Fuse, 25A (Qty=2 per phase)	C
3.5	91120032	91120022	Board (Print) I120	
3.6	91119010	91119010	RJ-45 Board (Print) 119	C
3.7	32060406	32060406	Feed-Through Coupling, 4pol. / 16mm ²	
3.8	94090007	94090007	Axial Fan for IN/MO	C
3.9	91109012	91109012	Board (Print) I109c Supply and CAN Interface	
4	98100518	98101330	Coil Carrier Sheet, Complete Assembly, 5.0kW Round Coil, 319 x 624 mm	
4.1	94040130	94040130	Sensor Unit, Round Coil, incl. 3xPT Sensors, 1k	C
4.2	93005090	93013081	Induction Coil and Sensor Assembly (with 3xPT Sensors)	
4.3	32060406	32060406	Feed-through Coupling, 4pol / 16mm ²	
4.4	91162011	91162011	(Print I162a) Sub-D, Adapter Board 90deg.	
4.5	60595006	60595006	Screw	
4.6	73000003	73000003	Spring	
4.7	65840003	65840003	Pin	
5	94030221	94030221	Control Unit Assembly, IN/MO 7000/10000, 208V/400V	C
6	94030040	94030040	Operation IN/MO Assembly, 6pol. (Includes items 6.1, 6.2, 6.3, and cable)	C
6.1	94010001	94010001	Potentiometer with Connector, 2pol, cable not included.	C
6.2	39400001	39400001	Plastic Knob, 0-12	
6.3	35624009	35624009	Front Indicator Lamp 24V LED Green, Chrome	
7	95000240	95000191	Cable Kit, Round Coil, IN/MO 7000/10000, 2.5-Meter Kit	
	95000241	95000192	Cable Kit, Round Coil, IN/MO 7000/10000, 4.0-Meter Kit (Option)	
	95000242	95000197	Cable Kit, Round Coil, IN/MO 7000/10000, 6.0-Meter Kit (Option)	
7.1	38601151	38601151	Sensor Cable, D-SUB 15pol., 1-meter	
	38602060	38602080	CAN/BUS RJ-45 Cable, 3-meter / UTP	
7.2	38602061	38602081	CAN/BUS RJ-45 Cable, 5-meter / UTP (Option)	
	38602062		CAN/BUS RJ-45 Cable, 7-meter / UTP (Option)	
	94900269	94900240	Induction Coil Connection Cable, IN/MO, 2.5-meter	
7.3	94900284	94900241	Induction Coil Connection Cable, IN/MO, 4.0-meter (Option)	
	94900285	94900242	Induction Coil Connection Cable, IN/MO, 6.0-meter (Option)	

RECOMMENDED STOCK PARTS

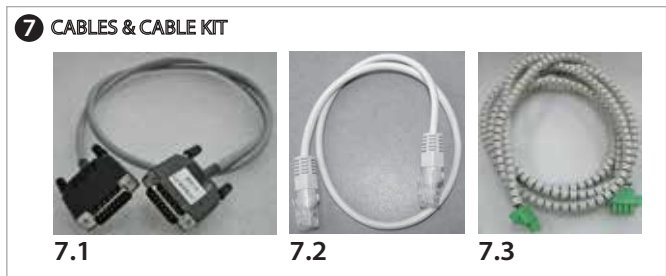
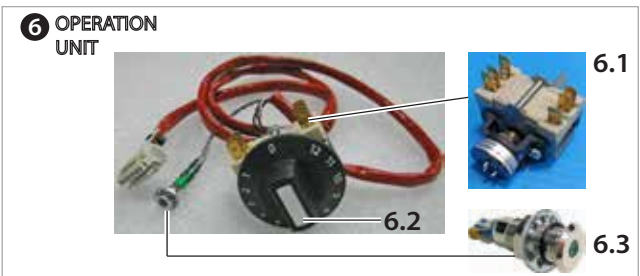
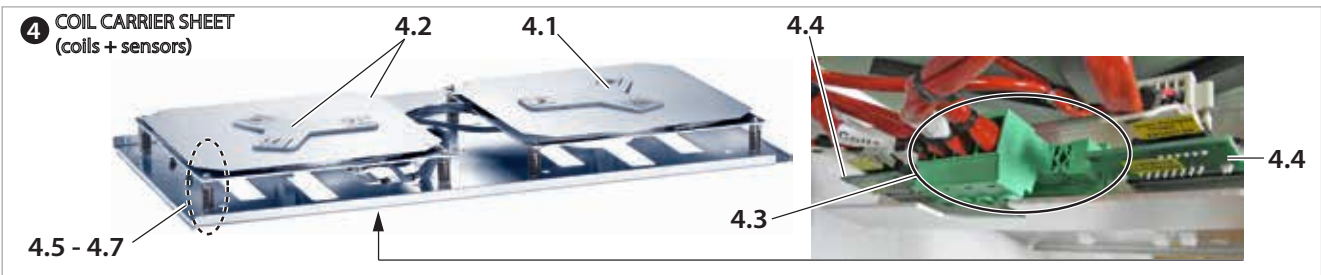
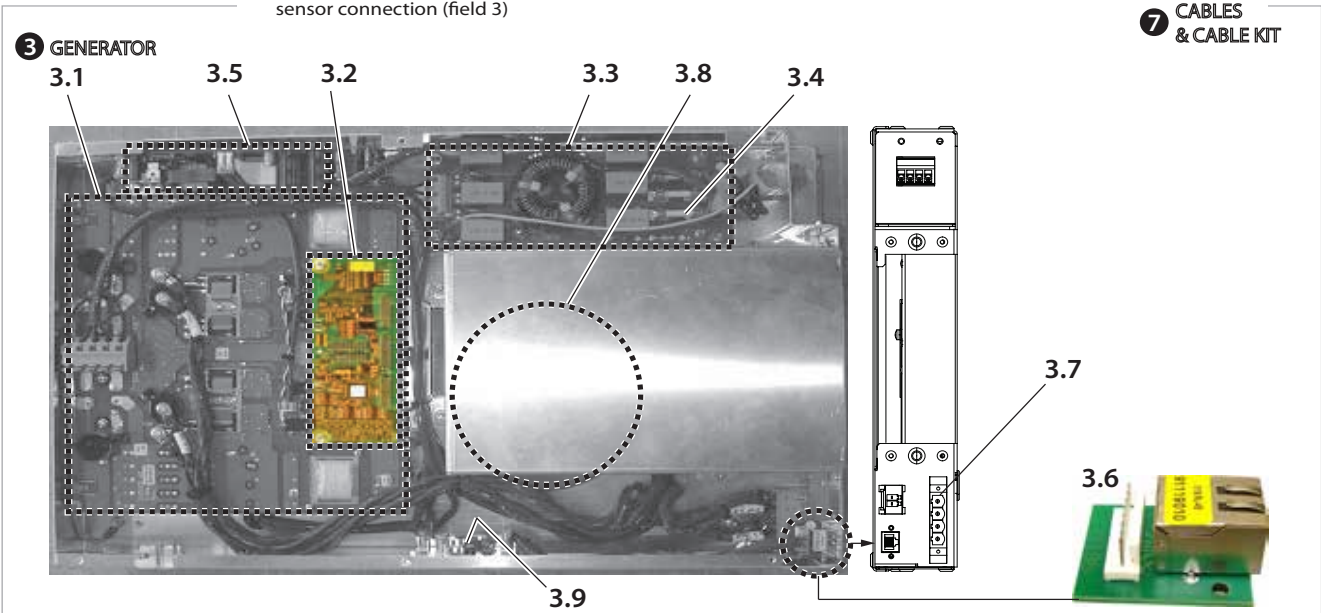
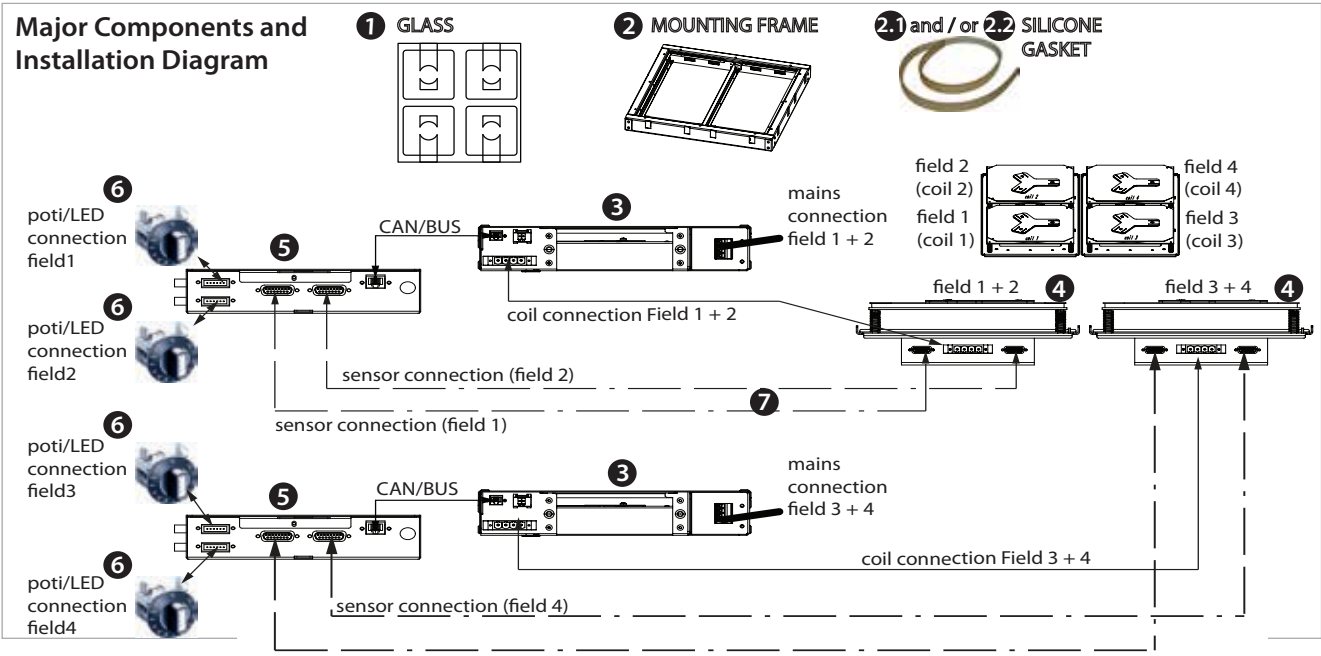

GARLAND PARTS IDENTIFICATION
MO QU 20000 720 208V 2x 10kW 50/60Hz 3Phase 30A
MO QU 20000 720 400V 2x 10kW 50/60Hz 3Phase 15A

ITEM	208V PART#	400V PART#	DESCRIPTION	CRITICAL
1	77727201	77727201	Ceran Glass-Top, Round Coil, 4-Cookzone, 720x 720x 6mm	
2	95000079	95000079	Mounting Frame for 720x 720mm Glass Size, Incl. Silicone Gaskets	
2.2	70000008	70000008	Silicone Gasket, 710x 12x 3mm	
3	99610331	99610330	Generator, Complete Assembly, IN/MO 10000	
3.1	98012661	98012611	Power Module Assembly	C
3.2	91131140	91131160	CPU Board (Print)	
3.3	91168030	91167010	Mains Filter Board (Print)	
3.4	34150259	34150259	Fuse, 25A (Qty=2 per phase)	C
3.5	91120032	91120022	Board (Print) I120	
3.6	91119010	91119010	RJ-45 Board (Print) 119	C
3.7	32060406	32060406	Feed-Through Coupling, 4pol. / 16mm ²	
3.8	94090007	94090007	Axial Fan for IN/MO	C
3.9	91109012	91109012	Board (Print) I109c Supply and CAN Interface	
4	98100514	98101322	Coil Carrier Sheet, Complete Assembly, 5.0kW Round Coil, 354.5 x 689 mm	
4.1	94040130	94040130	Sensor Unit, Round Coil, incl. 3xPT Sensors, 1k	C
4.2	93005090	93013081	Induction Coil and Sensor Assembly (with 3xPT Sensors)	
4.3	32060406	32060406	Feed-through Coupling, 4pol / 16mm ²	
4.4	91162011	91162011	(Print I162a) Sub-D, Adapter Board 90deg.	
4.5	60595006	60595006	Screw	
4.6	73000003	73000003	Spring	
4.7	65840003	65840003	Pin	
5	94030221	94030221	Control Unit Assembly, IN/MO 7000/10000, 208V/400V	C
6	94030040	94030040	Operation IN/MO Assembly, 6pol. (Includes items 6.1, 6.2, 6.3, and cable)	C
6.1	94010001	94010001	Potentiometer with Connector, 2pol, cable not included.	C
6.2	39400001	39400001	Plastic Knob, 0-12	
6.3	35624009	35624009	Front Indicator Lamp 24V LED Green, Chrome	
7	95000240	95000191	Cable Kit, Round Coil, IN/MO 7000/10000, 2.5-Meter Kit	
	95000241	95000192	Cable Kit, Round Coil, IN/MO 7000/10000, 4.0-Meter Kit (Option)	
	95000242	95000197	Cable Kit, Round Coil, IN/MO 7000/10000, 6.0-Meter Kit (Option)	
7.1	38601151	38601151	Sensor Cable, D-SUB 15pol., 1-meter	
	38602060	38602080	CAN/BUS RJ-45 Cable, 3-meter / UTP	
7.2	38602061	38602081	CAN/BUS RJ-45 Cable, 5-meter / UTP (Option)	
	38602062		CAN/BUS RJ-45 Cable, 7-meter / UTP (Option)	
	94900269	94900240	Induction Coil Connection Cable, IN/MO, 2.5-meter	
7.3	94900284	94900241	Induction Coil Connection Cable, IN/MO, 4.0-meter (Option)	
	94900285	94900242	Induction Coil Connection Cable, IN/MO, 6.0-meter (Option)	

RECOMMENDED STOCK PARTS

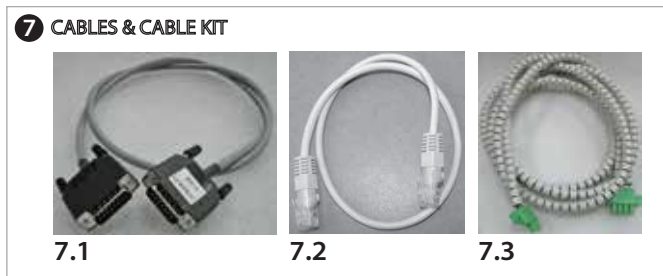
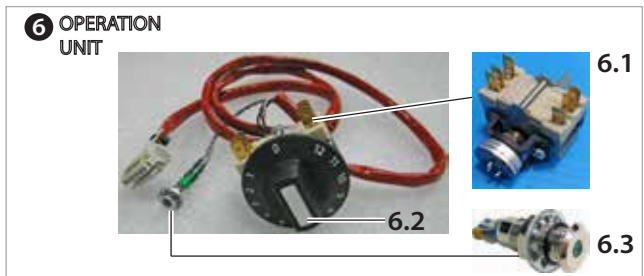
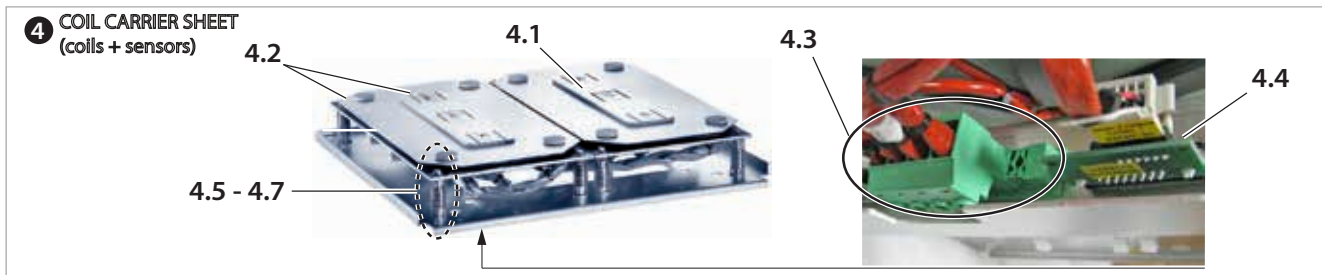
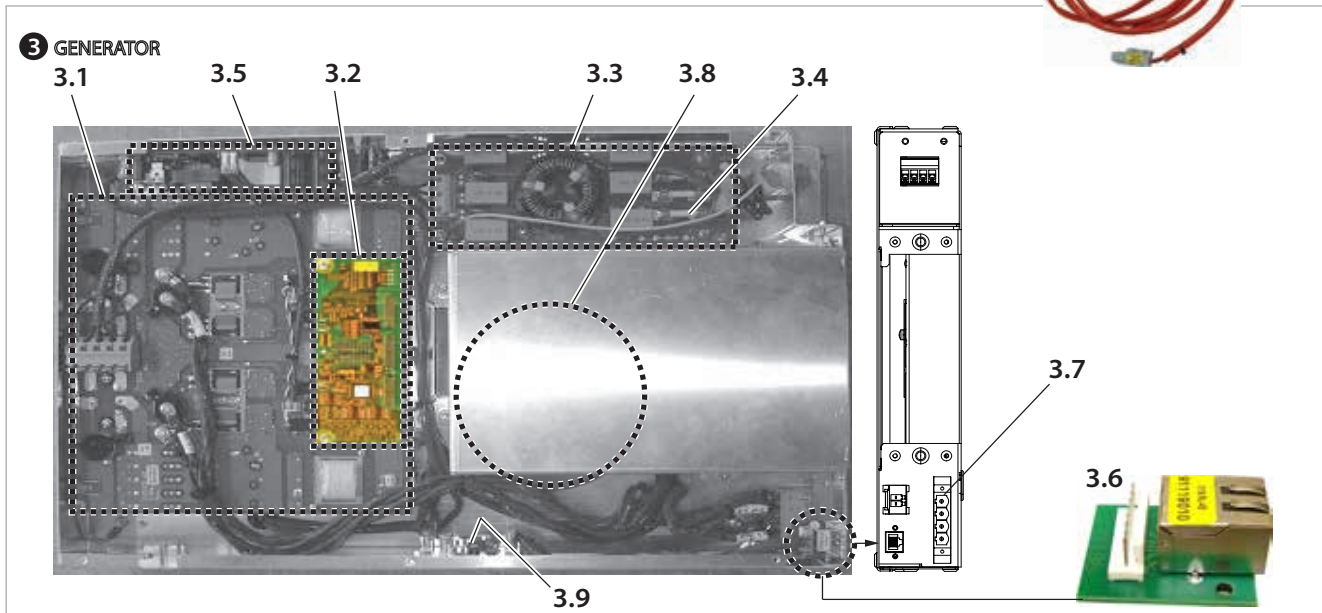
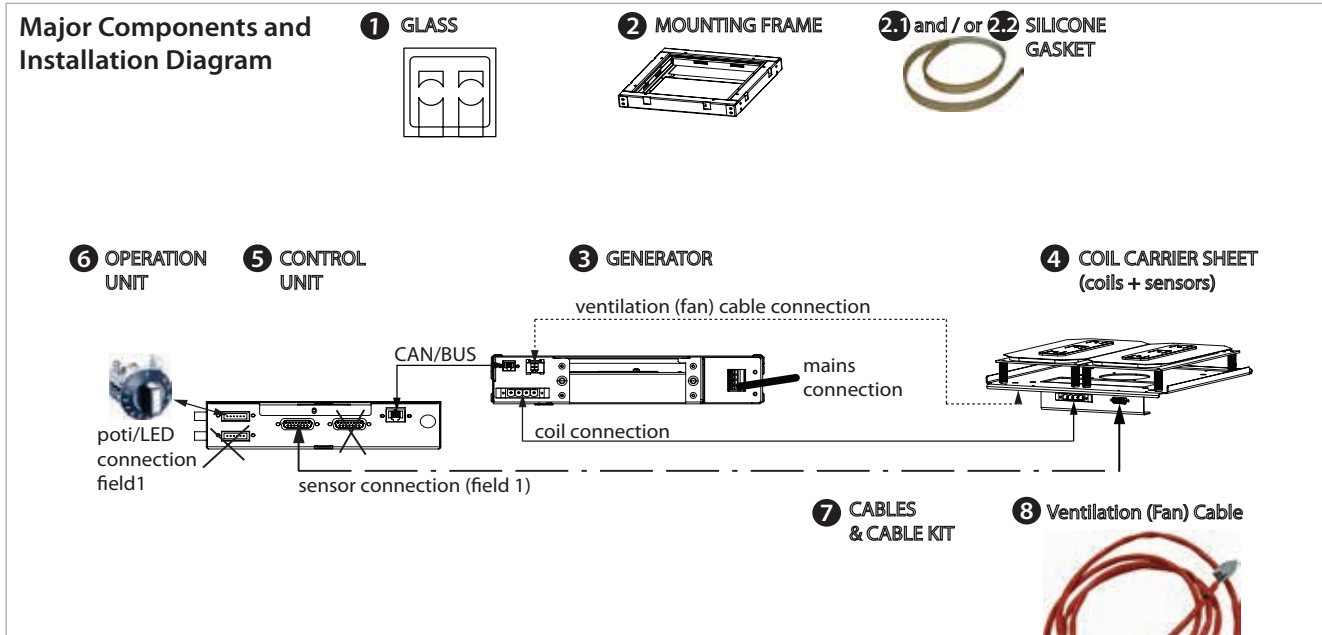

GARLAND PARTS IDENTIFICATION
MO DU 7000 360FL 208V 7kW 50/60Hz 3Phase 22A
MO DU 7000 360FL 400V 7kW 50/60Hz 3Phase 10A

ITEM	208V PART#	400V PART#	DESCRIPTION	CRITICAL
1	77363602	77363602	Ceran Glass-Top, Full Coil, 1-Cookzone, 360x 360x 6mm	
2	95000075	95000075	Mounting Frame for 360x 360mm Glass Size, Incl. Silicone Gaskets	
2.1	70000007	70000007	Silicone Gasket, 350x 12x 3mm	
3	99610326	99610325	Generator, Complete Assembly, IN/MO 7000FL	
3.1	98012661	98012621	Power Module Assembly	C
3.2	91131180	91131200	CPU Board (Print)	
3.3	91168030	91167010	Mains Filter Board (Print)	
3.4	34150259	34150259	Fuse, 25A (Qty=2 per phase)	C
3.5	91120032	91120022	Board (Print) I120	
3.6	91119010	91119010	RJ-45 Board (Print) 119	C
3.7	32060406	32060406	Feed-Through Coupling, 4pol. / 16mm ²	
3.8	94090007	94090007	Axial Fan for IN/MO	C
3.9	91109012	91109012	(Print I109c) Supply and CAN-BUS Interface Board	
4	98102670	98102641	Coil Carrier Sheet, Complete Assembly, 3.5kW Full Coil, 344 x 355 mm	
4.1	94040090	94040090	Sensor Unit, Full/Rectangular Coil, incl. 3xPT Sensors, 1k	C
4.2	93026150	93026120	Induction Coil and Sensor Assembly (with 3xPT Sensors)	
4.3	32060406	32060406	Feed-through Coupling, 4pol / 16mm ²	
4.4	91161010	91161010	Print/Board I161a, Sub-D, Adapter 90deg.	
4.5	60595006	60595006	Screw	
4.6	73000003	73000003	Spring	
4.7	65840003	65840003	Pin	
5	94030240	94030240	Control Unit Assembly, IN/MO 7000/14000, 208V/400V	C
6	94030040	94030040	Operation IN/MO Assembly, 6pol. (Includes items 6.1, 6.2, 6.3, and cable)	C
6.1	94010001	94010001	Potentiometer with Connector, 2pol, cable not included.	C
6.2	39400001	39400001	Plastic Knob, 0-12	
6.3	35624009	35624009	Front Indicator Lamp 24V LED Green, Chrome	
7	95000255	95000220	Cable Kit, Full Coil, IN/MO 7000-360FL, 2.5-Meter Kit	
	95000256	95000221	Cable Kit, Full Coil, IN/MO 7000-360FL, 4.0-Meter Kit (Option)	
	95000257	95000222	Cable Kit, Full Coil, IN/MO 7000-360FL, 6.0-Meter Kit (Option)	
7.1	38601151	38601151	Sensor Cable, D-SUB 15pol., 1-meter	
	38602060	38602080	CAN/BUS RJ-45 Cable, 3-meter / UTP	
7.2	38602061	38602081	CAN/BUS RJ-45 Cable, 5-meter / UTP (Option)	
	38602062		CAN/BUS RJ-45 Cable, 7-meter / UTP (Option)	
	94900269	94900134	Induction Coil Connection Cable, IN/MO, 2.5-meter	
7.3	94900284	94900132	Induction Coil Connection Cable, IN/MO, 4.0-meter (Option)	
	94900285	94900184	Induction Coil Connection Cable, IN/MO, 6.0-meter (Option)	
8	94900143	94900143	Cable, Fan/Ventilation	

RECOMMENDED STOCK PARTS

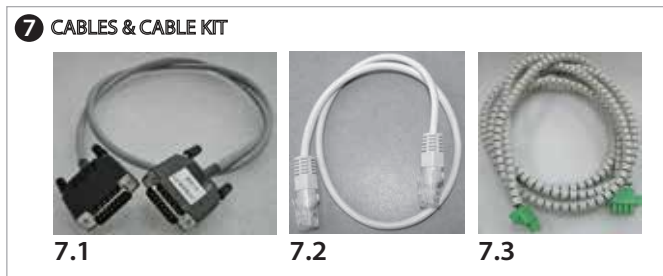
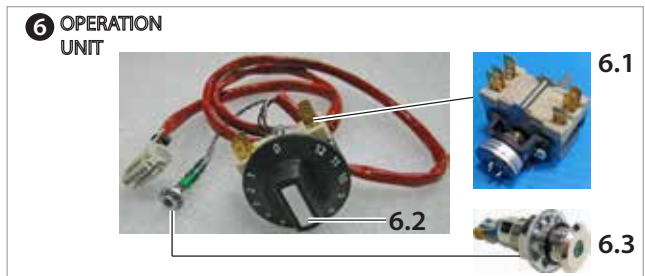
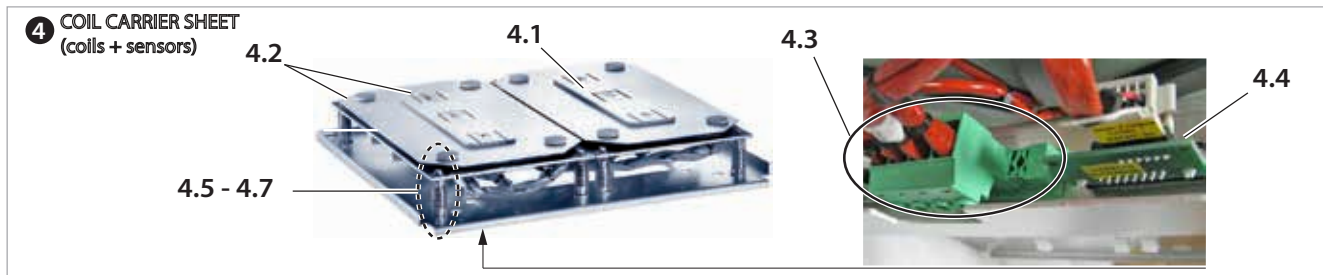
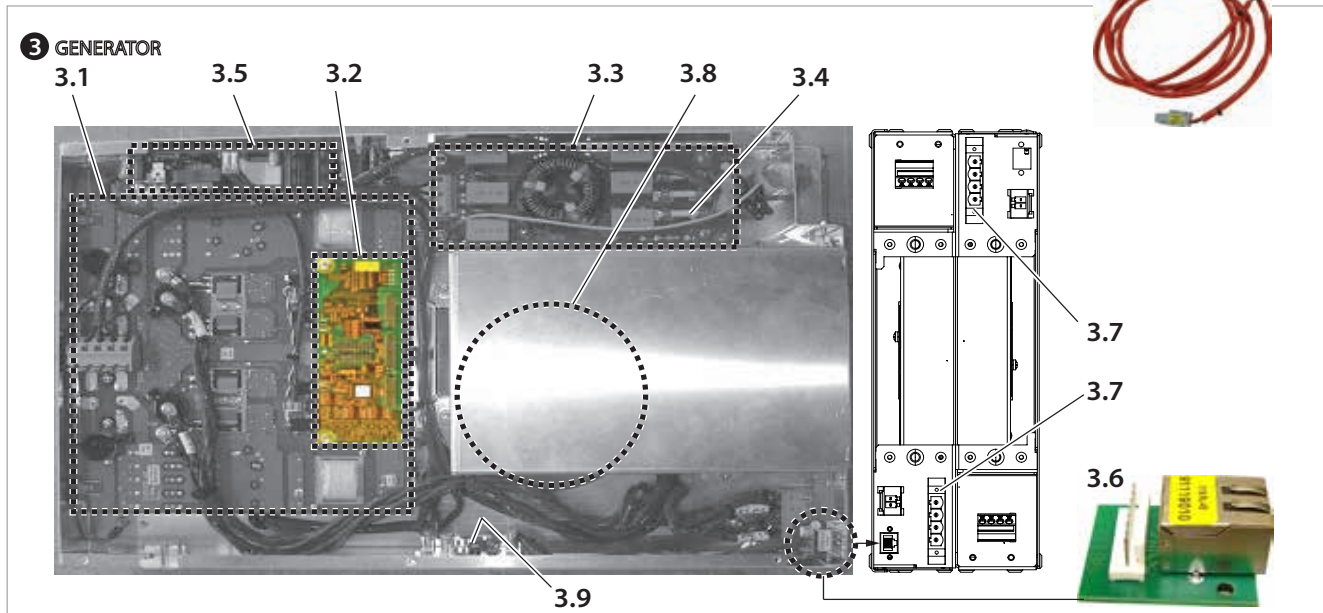
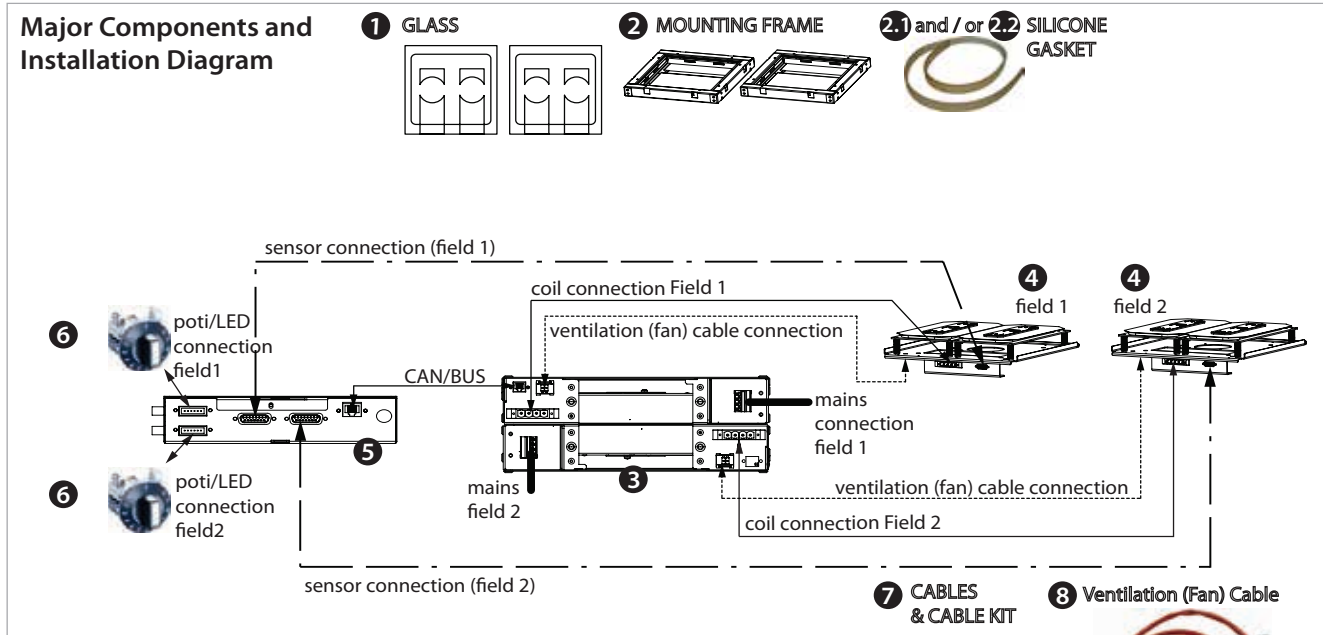

GARLAND PARTS IDENTIFICATION
MO DU 14000 360FL 208V 2x 7kW 50/60Hz 3Phase 21A
MO DU 14000 360FL 400V 2x 7kW 50/60Hz 3Phase 20A

ITEM	208V PART#	400V PART#	DESCRIPTION	CRITICAL
1	77363602	77363602	Ceran Glass-Top, Full Coil, 1-Cookzone, 360x 360x 6mm	
2	95000075	95000075	Mounting Frame for 360x 360mm Glass Size, Incl. Silicone Gaskets	
2.1	70000007	70000007	Silicone Gasket, 350x 12x 3mm	
3	99610347	99610345	Generator, Complete Assembly, IN/MO 14000FL	
3.1	98012661	98012621	Power Module Assembly	C
3.2	91131180	91131200	CPU Board (Print)	
3.3	91168030	91167010	Mains Filter Board (Print)	
3.4	34150259	34150259	Fuse, 25A (Qty=2 per phase)	
3.5	91120032	91120022	Board (Print) I120	
3.6	91119010	91119010	RJ-45 Board (Print) 119	C
3.7	32060406	32060406	Feed-Through Coupling, 4pol. / 16mm ²	
3.8	94090007	94090007	Axial Fan for IN/MO	C
3.9	91109012	91109012	(Print I109c) Supply and CAN-BUS Interface Board	
4	98102670	98102641	Coil Carrier Sheet, Complete Assembly, 3.5kW Full Coil, 344 x 355 mm	
4.1	94040090	94040090	Sensor Unit, Full/Rectangular Coil, incl. 3xPT Sensors, 1k	C
4.2	93026150	93026120	Induction Coil and Sensor Assembly (with 3xPT Sensors)	
4.3	32060406	32060406	Feed-through Coupling, 4pol / 16mm ²	
4.4	91161010	91161010	Print/Board I161a, Sub-D, Adapter 90deg.	
4.5	60595006	60595006	Screw	
4.6	73000003	73000003	Spring	
4.7	65840003	65840003	Pin	
5	94030240	94030240	Control Unit Assembly, IN/MO 7000/14000, 208V/400V	C
6	94030040	94030040	Operation IN/MO Assembly, 6pol. (Includes items 6.1, 6.2, 6.3, and cable)	C
6.1	94010001	94010001	Potentiometer with Connector, 2pol, cable not included.	C
6.2	39400001	39400001	Plastic Knob, 0-12	
6.3	35624009	35624009	Front Indicator Lamp 24V LED Green, Chrome	
7	95000245	95000193	Cable Kit, Full Coil, IN/MO 14000, 2.5-Meter Cable Kit	
	95000246	95000194	Cable Kit, Full Coil, IN/MO 14000, 4.0-Meter Cable Kit (Option)	
	95000247	95000195	Cable Kit, Full Coil, IN/MO 14000, 6.0-Meter Cable Kit (Option)	
7.1	38601151	38601151	Sensor Cable, D-SUB 15pol., 1-meter	
	38602060	38602080	CAN/BUS RJ-45 Cable, 3-meter / UTP	
7.2	38602061	38602081	CAN/BUS RJ-45 Cable, 5-meter / UTP (Option)	
	38602062		CAN/BUS RJ-45 Cable, 7-meter / UTP (Option)	
	94900269	94900134	Induction Coil Connection Cable, IN/MO, 2.5-meter	
7.3	94900284	94900132	Induction Coil Connection Cable, IN/MO, 4.0-meter (Option)	
	94900285	94900184	Induction Coil Connection Cable, IN/MO, 6.0-meter (Option)	
8	94900143	94900143	Cable, Fan/Ventilation	

RECOMMENDED STOCK PARTS

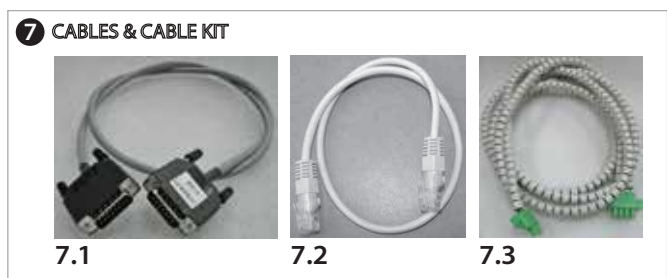
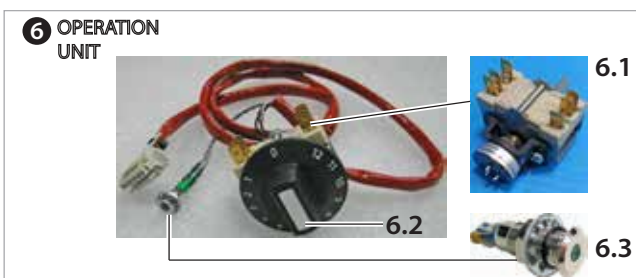
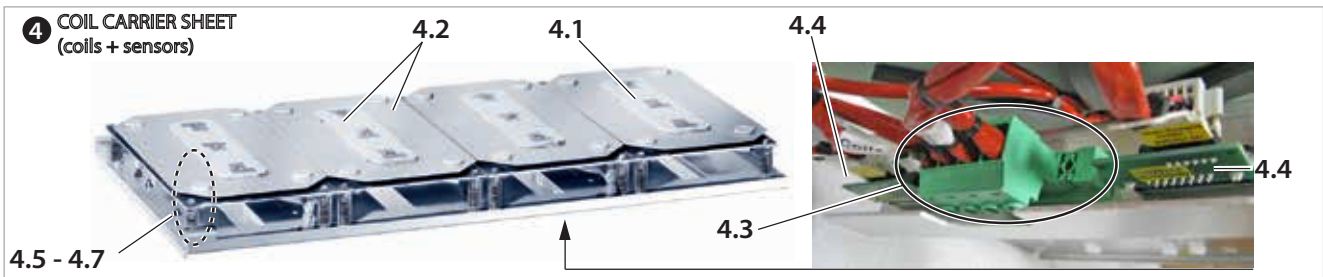
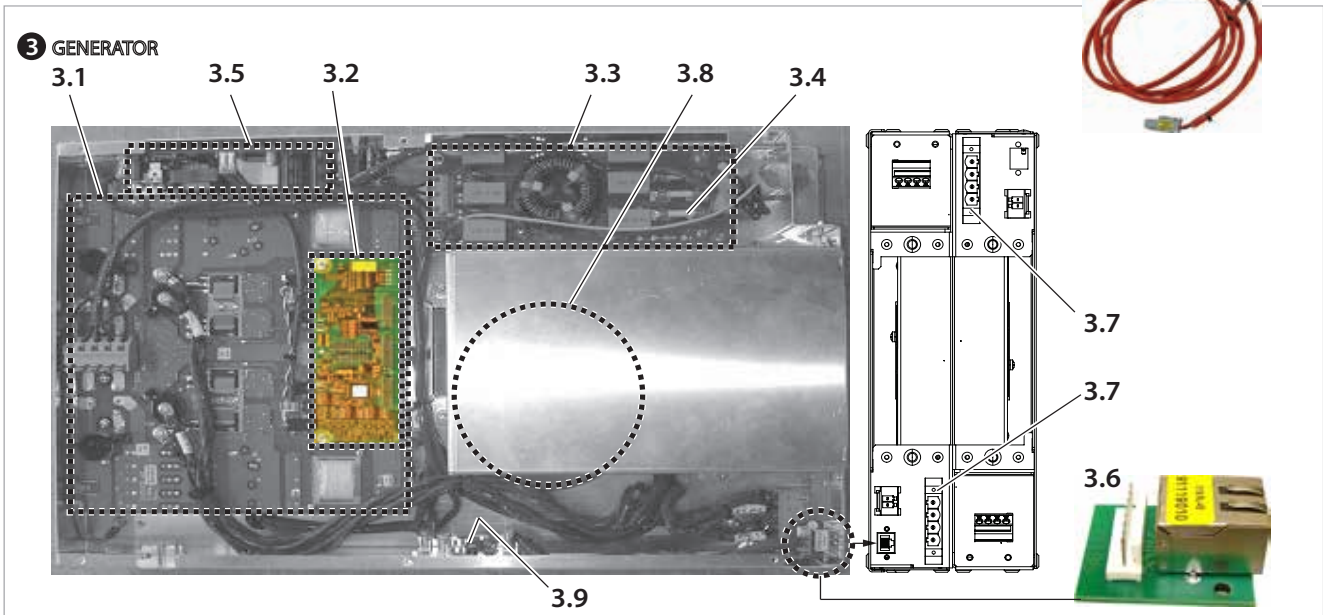
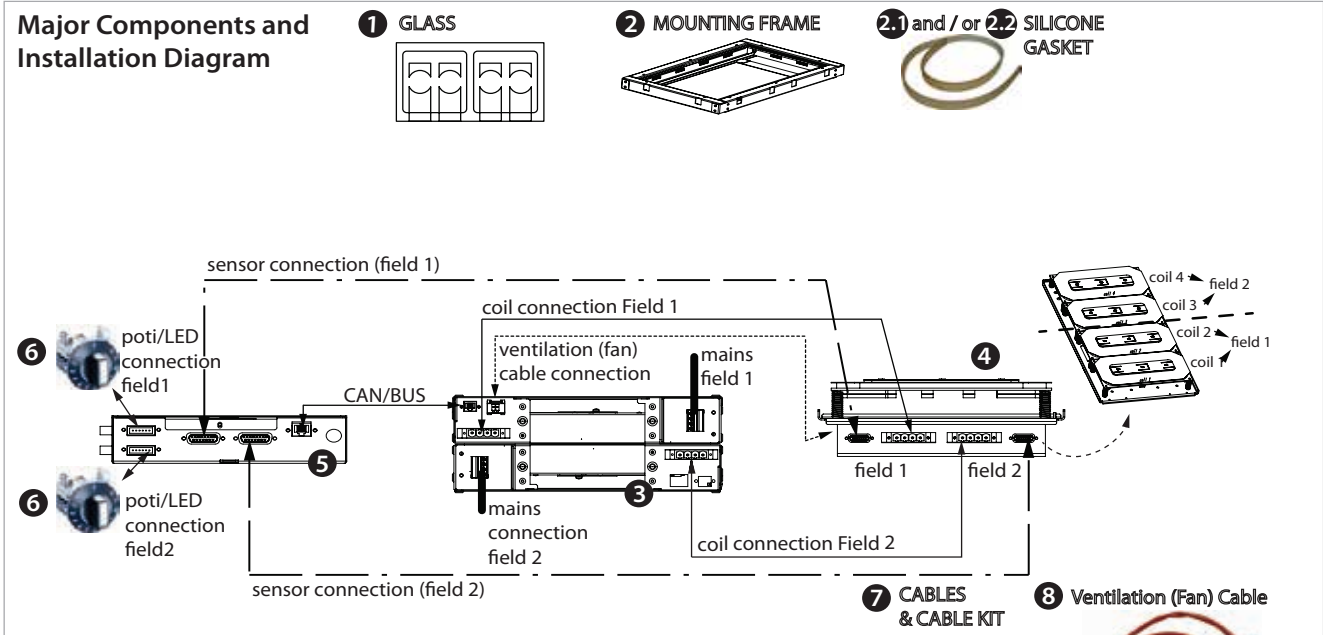

GARLAND PARTS IDENTIFICATION
MO DU 14000 650FL 208V 2x 7kW 50/60Hz 3Phase 21A
MO DU 14000 650FL 400V 2x 7kW 50/60Hz 3Phase 20A

ITEM	208V PART#	400V PART#	DESCRIPTION	CRITICAL
1	77376502	77376502	Ceran Glass-Top, Full Coil, 2-Cookzone, 375x 650x 6mm	
2	95000076	95000076	Mounting Frame for 375x 650mm Glass Size, Incl. Silicone Gaskets	
2.1	70000007	70000007	Silicone Gasket, 350x 12x 3mm	
2.2	70000008	70000008	Silicone Gasket, 710x 12x 3mm	
3	99610347	99610345	Generator, Complete Assembly, IN/MO 14000FL	
3.1	98012661	98012621	Power Module Assembly	C
3.2	91131180	91131200	CPU Board (Print)	
3.3	91168030	91167010	Mains Filter Board (Print)	
3.4	34150259	34150259	Fuse, 25A (Qty=2 per phase)	
3.5	91120032	91120022	Board (Print) I120	
3.6	91119010	91119010	RJ-45 Board (Print) 119	C
3.7	32060406	32060406	Feed-Through Coupling, 4pol. / 16mm ²	
3.8	94090007	94090007	Axial Fan for IN/MO	C
3.9	91109012	91109012	(Print I109c) Supply and CAN-BUS Interface Board	
4	98102660	98102631	Coil Carrier Sheet, Complete Assembly, 3.5kW Full Coil, 319 x 624 mm	
4.1	94040090	94040090	Sensor Unit, Full/Rectangular Coil, incl. 3xPT Sensors, 1k	C
4.2	93026160	93026131	Induction Coil and Sensor Assembly (with 3xPT Sensors)	
4.3	32060406	32060406	Feed-through Coupling, 4pol / 16mm ²	
4.4	91161010	91161010	Print/Board I161a, Sub-D, Adapter 90deg.	
4.5	60595006	60595006	Screw	
4.6	73000003	73000003	Spring	
4.7	65840003	65840003	Pin	
5	94030240	94030240	Control Unit Assembly, IN/MO 7000/14000, 208V/400V	C
6	94030040	94030040	Operation IN/MO Assembly, 6pol. (Includes items 6.1, 6.2, 6.3, and cable)	C
6.1	94010001	94010001	Potentiometer with Connector, 2pol, cable not included.	C
6.2	39400001	39400001	Plastic Knob, 0-12	
6.3	35624009	35624009	Front Indicator Lamp 24V LED Green, Chrome	
7	95000245	95000193	Cable Kit, Full Coil, IN/MO 14000, 2.5-Meter Cable Kit	
	95000246	95000194	Cable Kit, Full Coil, IN/MO 14000, 4.0-Meter Cable Kit (Option)	
	95000247	95000195	Cable Kit, Full Coil, IN/MO 14000, 6.0-Meter Cable Kit (Option)	
7.1	38601151	38601151	Sensor Cable, D-SUB 15pol., 1-meter	
	38602060	38602080	CAN/BUS RJ-45 Cable, 3-meter / UTP	
7.2	38602061	38602081	CAN/BUS RJ-45 Cable, 5-meter / UTP (Option)	
	38602062		CAN/BUS RJ-45 Cable, 7-meter / UTP (Option)	
	94900269	94900134	Induction Coil Connection Cable, IN/MO, 2.5-meter	
7.3	94900284	94900132	Induction Coil Connection Cable, IN/MO, 4.0-meter (Option)	
	94900285	94900184	Induction Coil Connection Cable, IN/MO, 6.0-meter (Option)	
8	94900143	94900143	Cable, Fan/Ventilation	

RECOMMENDED STOCK PARTS

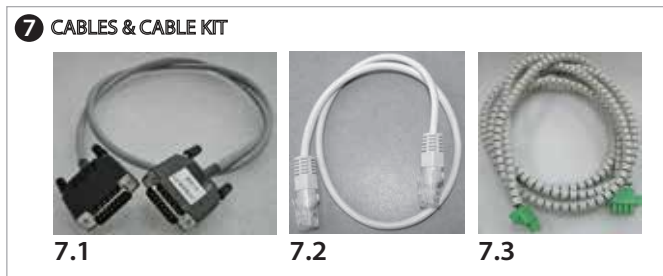
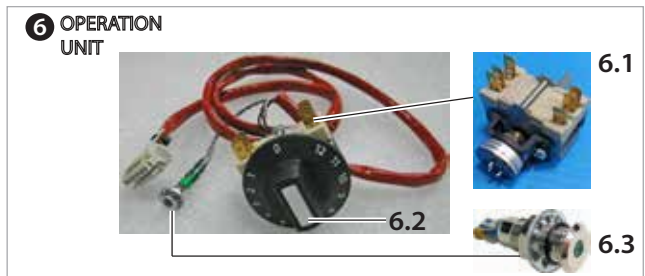
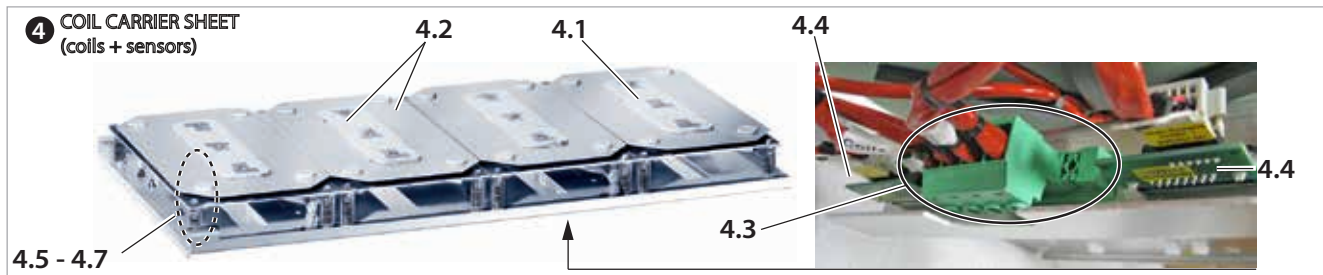
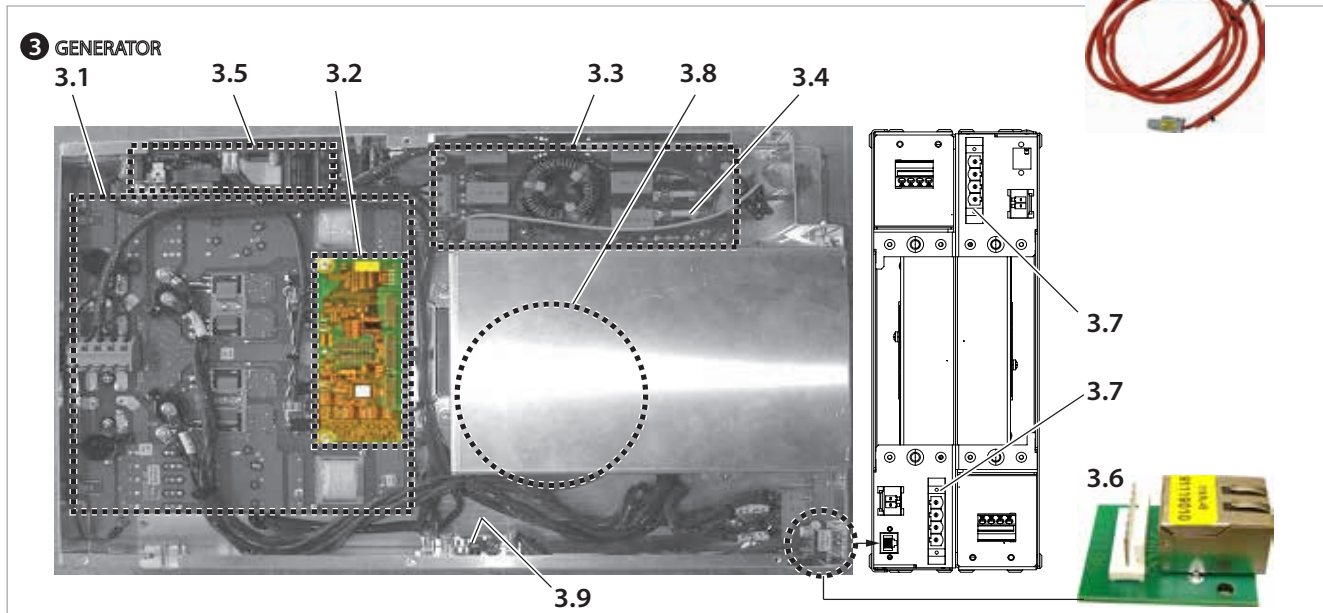
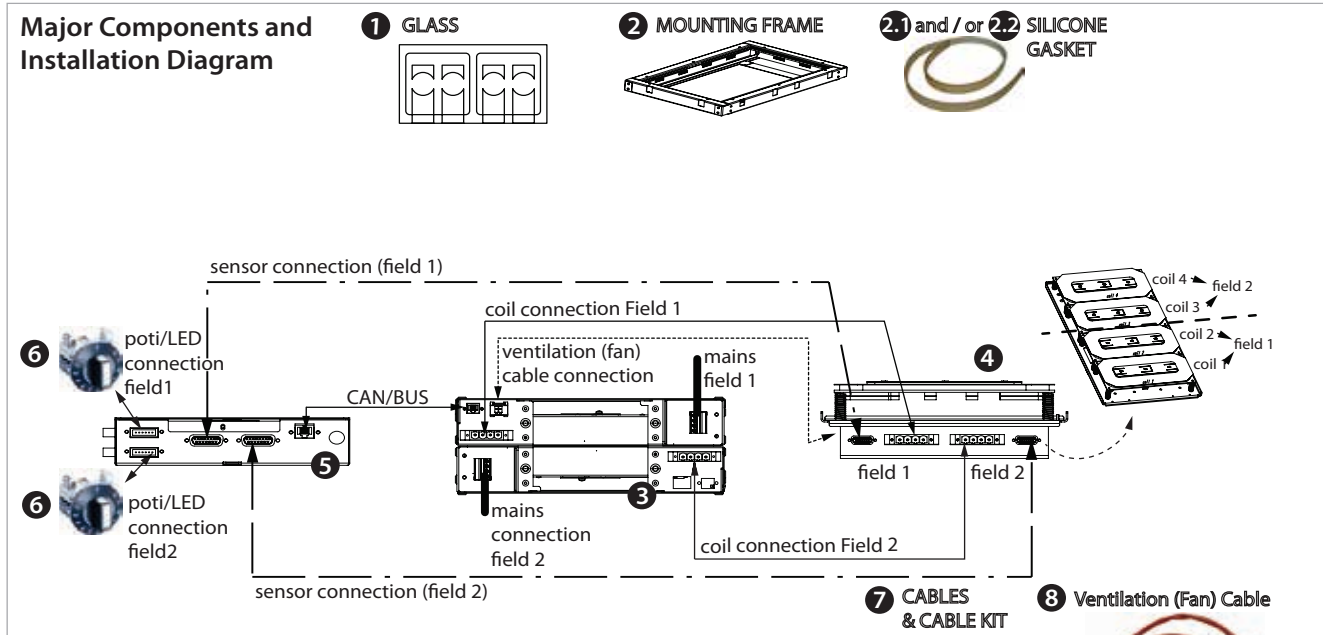

GARLAND PARTS IDENTIFICATION
MO DU 14000 720FL 208V 2x 7kW 50/60Hz 3Phase 21A
MO DU 14000 720FL 400V 2x 7kW 50/60Hz 3Phase 20A

ITEM	208V PART#	400V PART#	DESCRIPTION	CRITICAL
1	77367202	77367202	Ceran Glass-Top, Full Coil, 2-Cookzone, 360x 720x 6mm	
2	95000078	95000078	Mounting Frame for 360x 720mm Glass Size, Incl. Silicone Gaskets	
2.1	70000007	70000007	Silicone Gasket, 350x 12x 3mm	
2.2	70000008	70000008	Silicone Gasket, 710x 12x 3mm	
3	99610347	99610345	Generator, Complete Assembly, IN/MO 14000FL	
3.1	98012661	98012621	Power Module Assembly	C
3.2	91131180	91131200	CPU Board (Print)	
3.3	91168030	91167010	Mains Filter Board (Print)	
3.4	34150259	34150259	Fuse, 25A (Qty=2 per phase)	
3.5	91120032	91120022	Board (Print) I120	
3.6	91119010	91119010	RJ-45 Board (Print) 119	C
3.7	32060406	32060406	Feed-Through Coupling, 4pol. / 16mm ²	
3.8	94090007	94090007	Axial Fan for IN/MO	C
3.9	91109012	91109012	(Print I109c) Supply and CAN-BUS Interface Board	
4	98102650	98102621	Coil Carrier Sheet, Complete Assembly, 3.5kW Full Coil, 354.5 x 689 mm	
4.1	94040090	94040090	Sensor Unit, Full/Rectangular Coil, incl. 3xPT Sensors, 1k	C
4.2	93026150	93026120	Induction Coil and Sensor Assembly (with 3xPT Sensors)	
4.3	32060406	32060406	Feed-through Coupling, 4pol / 16mm ²	
4.4	91161010	91161010	Print/Board I161a, Sub-D, Adapter 90deg.	
4.5	60595006	60595006	Screw	
4.6	73000003	73000003	Spring	
4.7	65840003	65840003	Pin	
5	94030240	94030240	Control Unit Assembly, IN/MO 7000/14000, 208V/400V	C
6	94030040	94030040	Operation IN/MO Assembly, 6pol. (Includes items 6.1, 6.2, 6.3, and cable)	C
6.1	94010001	94010001	Potentiometer with Connector, 2pol, cable not included.	C
6.2	39400001	39400001	Plastic Knob, 0-12	
6.3	35624009	35624009	Front Indicator Lamp 24V LED Green, Chrome	
7	95000245	95000193	Cable Kit, Full Coil, IN/MO 14000, 2.5-Meter Cable Kit	
	95000246	95000194	Cable Kit, Full Coil, IN/MO 14000, 4.0-Meter Cable Kit (Option)	
	95000247	95000195	Cable Kit, Full Coil, IN/MO 14000, 6.0-Meter Cable Kit (Option)	
7.1	38601151	38601151	Sensor Cable, D-SUB 15pol., 1-meter	
	38602060	38602080	CAN/BUS RJ-45 Cable, 3-meter / UTP	
7.2	38602061	38602081	CAN/BUS RJ-45 Cable, 5-meter / UTP (Option)	
	38602062		CAN/BUS RJ-45 Cable, 7-meter / UTP (Option)	
	94900269	94900134	Induction Coil Connection Cable, IN/MO, 2.5-meter	
7.3	94900284	94900132	Induction Coil Connection Cable, IN/MO, 4.0-meter (Option)	
	94900285	94900184	Induction Coil Connection Cable, IN/MO, 6.0-meter (Option)	
8	94900143	94900143	Cable, Fan/Ventilation	

RECOMMENDED STOCK PARTS

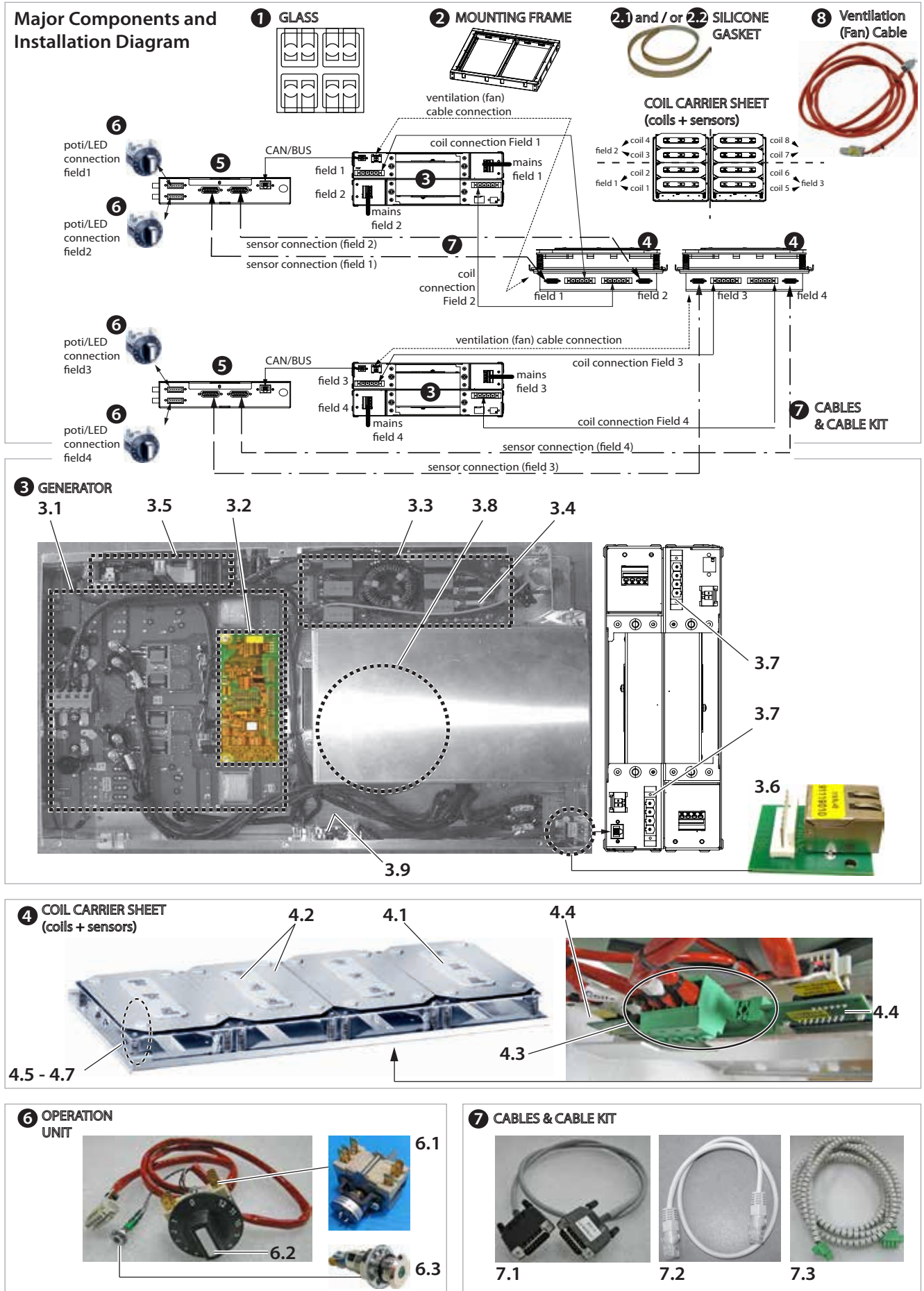

GARLAND PARTS IDENTIFICATION
MO QU 28000 650FL 208V 4x 7kW 50/60Hz 3Phase 21A
MO QU 28000 650FL 400V 4x 7kW 50/60Hz 3Phase 20A

ITEM	208V PART#	400V PART#	DESCRIPTION	CRITICAL
1	77656502	77656502	<i>Ceran Glass-Top, Full Coil, 4-Cookzone, 650x 650x 6mm</i>	
2	95000077	95000077	Mounting Frame for 650x 650mm Glass Size, Incl. Silicone Gaskets	
2.2	70000008	70000008	<i>Silicone Gasket, 710x 12x 3mm</i>	
3	99610347	99610345	Generator, Complete Assembly, IN/MO 14000FL	
3.1	98012661	98012621	<i>Power Module Assembly</i>	C
3.2	91131180	91131200	CPU Board (Print)	
3.3	91168030	91167010	Mains Filter Board (Print)	
3.4	34150259	34150259	<i>Fuse, 25A (Qty=2 per phase)</i>	
3.5	91120032	91120022	<i>Board (Print) I120</i>	
3.6	91119010	91119010	<i>RJ-45 Board (Print) 119</i>	C
3.7	32060406	32060406	Feed-Through Coupling, 4pol. / 16mm ²	
3.8	94090007	94090007	<i>Axial Fan for IN/MO</i>	C
3.9	91109012	91109012	<i>(Print I109c) Supply and CAN-BUS Interface Board</i>	
4	98102660	98102631	Coil Carrier Sheet, Complete Assembly, 3.5kW Full Coil, 319 x 624 mm	
4.1	94040090	94040090	<i>Sensor Unit, Full/Rectangular Coil, incl. 3xPT Sensors, 1k</i>	C
4.2	93026160	93026131	Induction Coil and Sensor Assembly (with 3xPT Sensors)	
4.3	32060406	32060406	Feed-through Coupling, 4pol / 16mm ²	
4.4	91161010	91161010	<i>Print/Board I161a, Sub-D, Adapter 90deg.</i>	
4.5	60595006	60595006	Screw	
4.6	73000003	73000003	Spring	
4.7	65840003	65840003	Pin	
5	94030240	94030240	<i>Control Unit Assembly, IN/MO 7000/14000, 208V/400V</i>	C
6	94030040	94030040	Operation IN/MO Assembly, 6pol. (Includes items 6.1, 6.2, 6.3, and cable)	C
6.1	94010001	94010001	<i>Potentiometer with Connector, 2pol, cable not included.</i>	C
6.2	39400001	39400001	Plastic Knob, 0-12	
6.3	35624009	35624009	<i>Front Indicator Lamp 24V LED Green, Chrome</i>	
7	95000245	95000193	Cable Kit, Full Coil, IN/MO 14000, 2.5-Meter Cable Kit	
	95000246	95000194	Cable Kit, Full Coil, IN/MO 14000, 4.0-Meter Cable Kit (Option)	
	95000247	95000195	Cable Kit, Full Coil, IN/MO 14000, 6.0-Meter Cable Kit (Option)	
7.1	38601151	38601151	Sensor Cable, D-SUB 15pol., 1-meter	
	38602060	38602080	<i>CAN/BUS RJ-45 Cable, 3-meter / UTP</i>	
7.2	38602061	38602081	<i>CAN/BUS RJ-45 Cable, 5-meter / UTP (Option)</i>	
	38602062		<i>CAN/BUS RJ-45 Cable, 7-meter / UTP (Option)</i>	
	94900269	94900134	Induction Coil Connection Cable, IN/MO, 2.5-meter	
7.3	94900284	94900132	Induction Coil Connection Cable, IN/MO, 4.0-meter (Option)	
	94900285	94900184	Induction Coil Connection Cable, IN/MO, 6.0-meter (Option)	
8	94900143	94900143	Cable, Fan/Ventilation	

RECOMMENDED STOCK PARTS

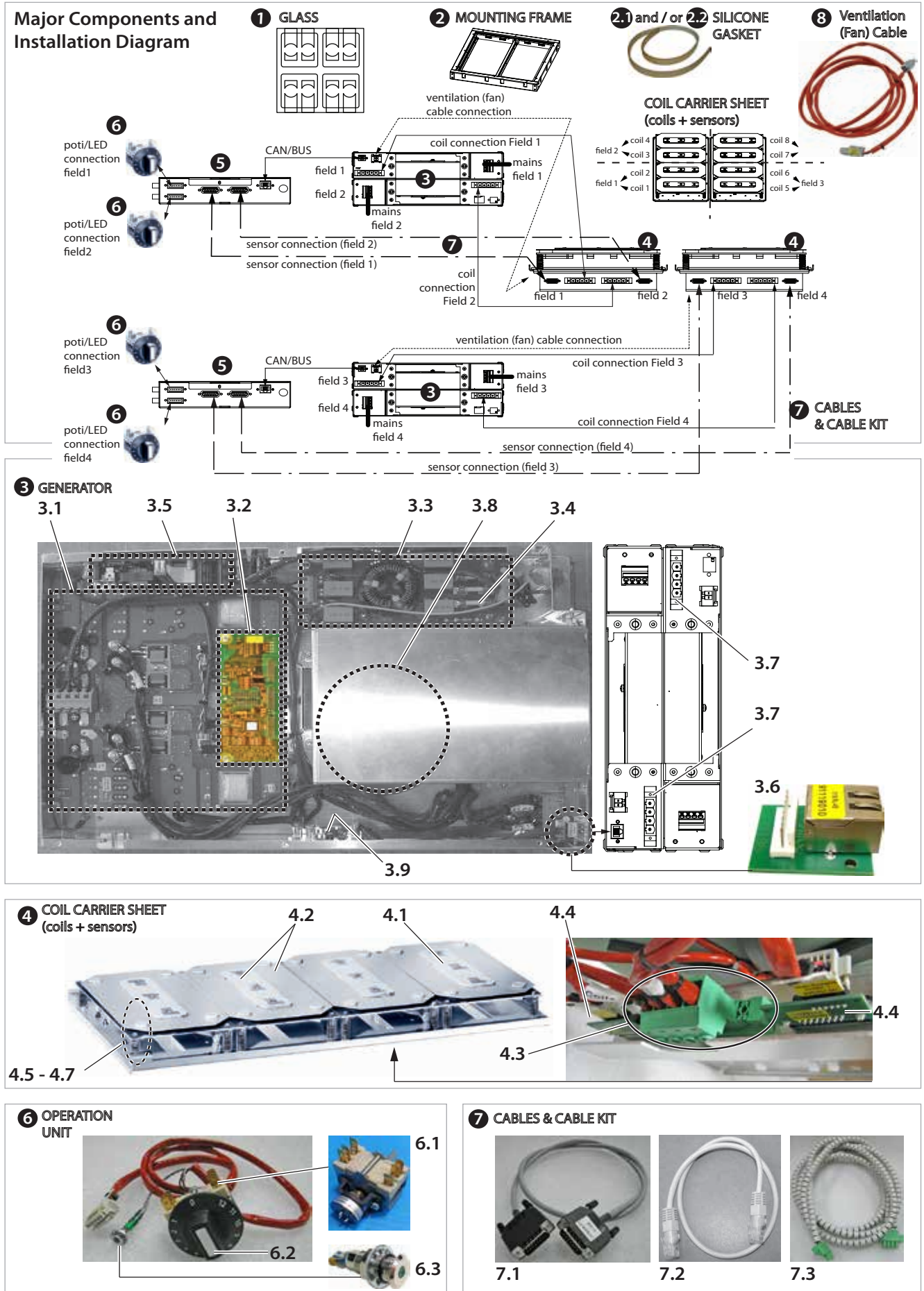

GARLAND PARTS IDENTIFICATION
MO QU 28000 720FL 208V 4x 7kW 50/60Hz 3Phase 21A
MO QU 28000 720FL 400V 4x 7kW 50/60Hz 3Phase 20A

ITEM	208V PART#	400V PART#	DESCRIPTION	CRITICAL
1	77727203	77727203	Ceran Glass-Top, Full Coil, 4-Cookzone, 720x 720x 6mm	
2	95000079	95000079	Mounting Frame for 720x 720mm Glass Size, Incl. Silicone Gaskets	
2.2	70000008	70000008	Silicone Gasket, 710x 12x 3mm	
3	99610347	99610345	Generator, Complete Assembly, IN/MO 14000FL	
3.1	98012661	98012621	Power Module Assembly	C
3.2	91131180	91131200	CPU Board (Print)	
3.3	91168030	91167010	Mains Filter Board (Print)	
3.4	34150259	34150259	Fuse, 25A (Qty=2 per phase)	
3.5	91120032	91120022	Board (Print) I120	
3.6	91119010	91119010	RJ-45 Board (Print) 119	C
3.7	32060406	32060406	Feed-Through Coupling, 4pol. / 16mm ²	
3.8	94090007	94090007	Axial Fan for IN/MO	C
3.9	91109012	91109012	(Print I109c) Supply and CAN-BUS Interface Board	
4	98102650	98102621	Coil Carrier Sheet, Complete Assembly, 3.5kW Full Coil, 354.5 x 689 mm	
4.1	94040090	94040090	Sensor Unit, Full/Rectangular Coil, incl. 3xPT Sensors, 1k	C
4.2	93026150	93026120	Induction Coil and Sensor Assembly (with 3xPT Sensors)	
4.3	32060406	32060406	Feed-through Coupling, 4pol / 16mm ²	
4.4	91161010	91161010	Print/Board I161a, Sub-D, Adapter 90deg.	
4.5	60595006	60595006	Screw	
4.6	73000003	73000003	Spring	
4.7	65840003	65840003	Pin	
5	94030240	94030240	Control Unit Assembly, IN/MO 7000/14000, 208V/400V	C
6	94030040	94030040	Operation IN/MO Assembly, 6pol. (Includes items 6.1, 6.2, 6.3, and cable)	C
6.1	94010001	94010001	Potentiometer with Connector, 2pol, cable not included.	C
6.2	39400001	39400001	Plastic Knob, 0-12	
6.3	35624009	35624009	Front Indicator Lamp 24V LED Green, Chrome	
7	95000245	95000193	Cable Kit, Full Coil, IN/MO 14000, 2.5-Meter Cable Kit	
	95000246	95000194	Cable Kit, Full Coil, IN/MO 14000, 4.0-Meter Cable Kit (Option)	
	95000247	95000195	Cable Kit, Full Coil, IN/MO 14000, 6.0-Meter Cable Kit (Option)	
7.1	38601151	38601151	Sensor Cable, D-SUB 15pol., 1-meter	
	38602060	38602080	CAN/BUS RJ-45 Cable, 3-meter / UTP	
7.2	38602061	38602081	CAN/BUS RJ-45 Cable, 5-meter / UTP (Option)	
	38602062		CAN/BUS RJ-45 Cable, 7-meter / UTP (Option)	
	94900269	94900134	Induction Coil Connection Cable, IN/MO, 2.5-meter	
7.3	94900284	94900132	Induction Coil Connection Cable, IN/MO, 4.0-meter (Option)	
	94900285	94900184	Induction Coil Connection Cable, IN/MO, 6.0-meter (Option)	
8	94900143	94900143	Cable, Fan/Ventilation	

RECOMMENDED STOCK PARTS

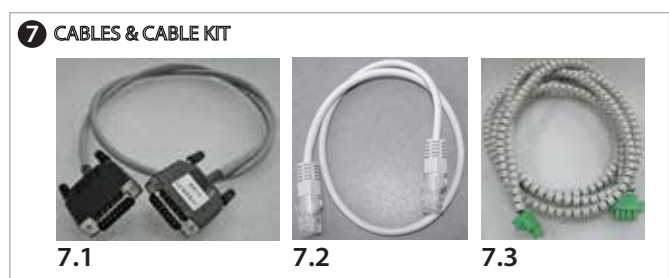
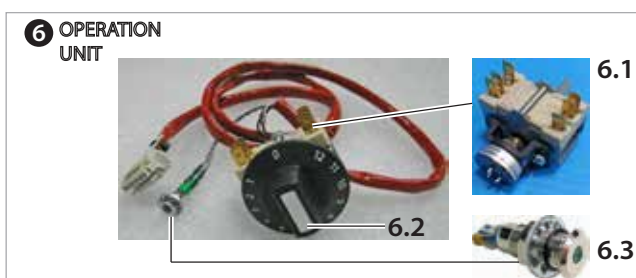
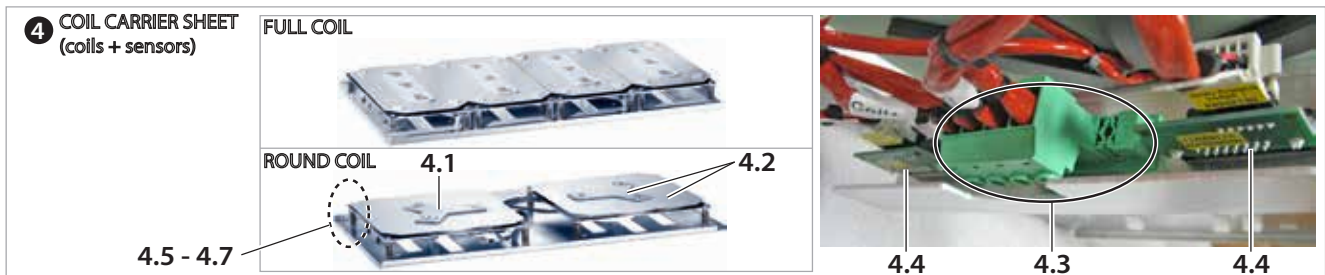
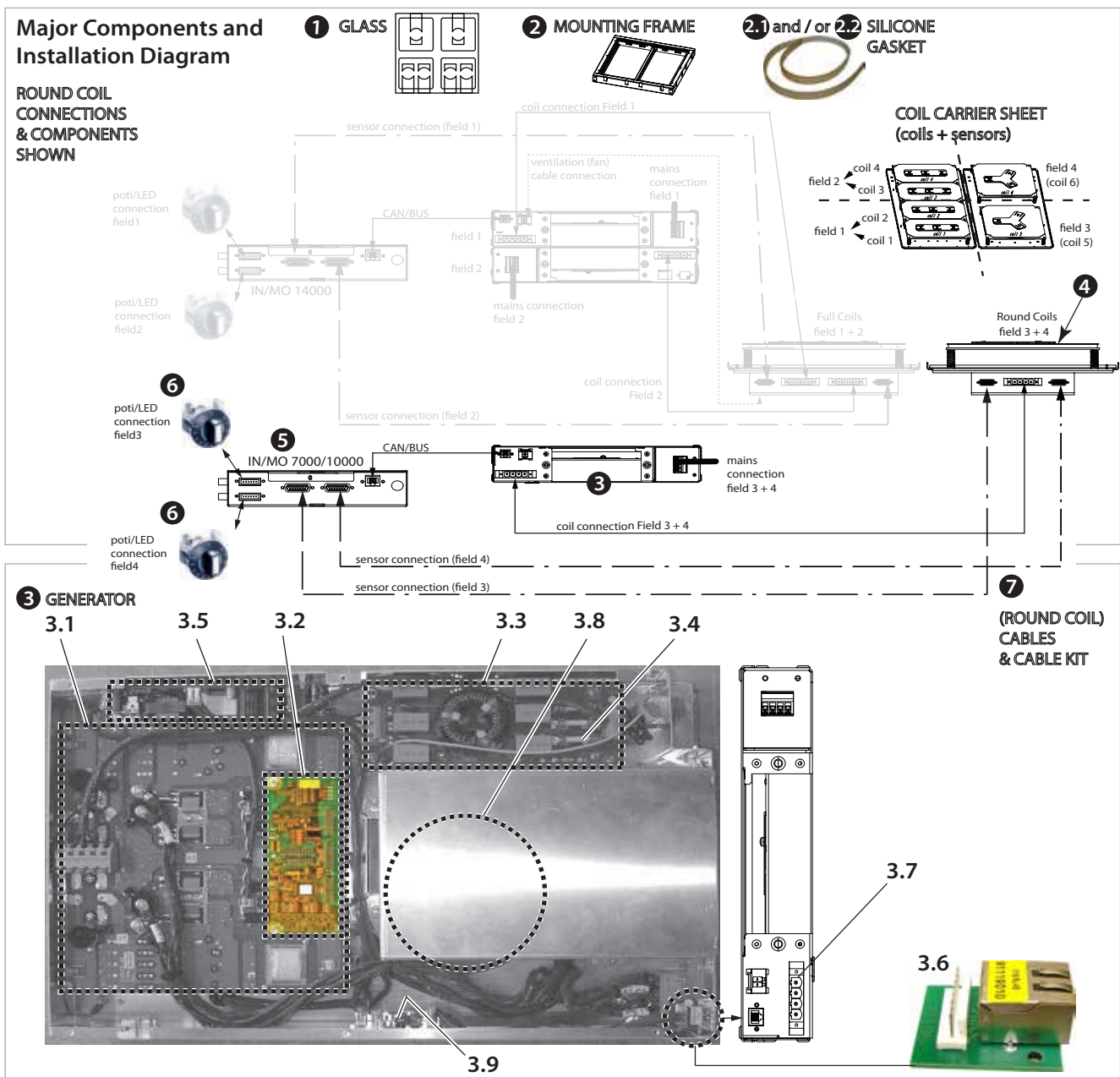

GARLAND PARTS IDENTIFICATION

MO QU 21000 720 208V

MO QU 21000 720 400V

ITEM	208V PART#	400V PART#	DESCRIPTION	CRITICAL
1	77727202	77727202	<i>Ceran Glass-Top, Full+Round Coil, 4-Cookzone, 720x 720x 6mm</i>	
2	95000079	95000079	Mounting Frame for 720x 720mm Glass Size, Incl. Silicone Gaskets	
2.2	70000008	70000008	<i>Silicone Gasket, 710x 12x 3mm</i>	

ROUND-COIL SECTION COMPONENTS

3	99610321	99610320	Generator, Complete Assembly, IN/MO 7000	
3.1	98012661	98012611	<i>Power Module Assembly</i>	C
3.2	91131100	91131120	CPU Board (Print)	
3.3	91168030	91167010	Mains Filter Board (Print)	
3.4	34150259	34150259	<i>Fuse, 25A (Qty=2 per phase)</i>	C
3.5	91120032	91120022	<i>Board (Print) I120</i>	
3.6	91119010	91119010	<i>RJ-45 Board (Print) 119</i>	C
3.7	32060406	32060406	Feed-Through Coupling, 4pol. / 16mm ²	
3.8	94090007	94090007	<i>Axial Fan for IN/MO</i>	C
3.9	91109012	91109012	<i>(Print I109c) Supply and CAN-BUS Interface Board</i>	
4	98100513	98101218	Coil Carrier Sheet, Complete Assembly, 3.5kW Round Coil, 354.5 x 689 mm	
4.1	94040130	94040130	<i>Sensor Unit, Round Coil, incl. 3xPT Sensors, 1k</i>	C
4.2	93005090	93013081	Induction Coil and Sensor Assembly (with 3xPT Sensors)	
4.3	32060406	32060406	Feed-through Coupling, 4pol / 16mm ²	
4.4	91162011	91162011	<i>(Print I162a) Sub-D, Adapter Board 90deg.</i>	
4.5	60595006	60595006	Screw	
4.6	73000003	73000003	Spring	
4.7	65840003	65840003	Pin	
5	94030221	94030221	<i>Control Unit Assembly, IN/MO 7000/10000, 208V/400V</i>	C
6	94030040	94030040	Operation IN/MO Assembly, 6pol. (Includes items 6.1, 6.2, 6.3, and cable)	C
6.1	94010001	94010001	<i>Potentiometer with Connector, 2pol, cable not included.</i>	C
6.2	39400001	39400001	Plastic Knob, 0-12	
6.3	35624009	35624009	<i>Front Indicator Lamp 24V LED Green, Chrome</i>	
7	95000240	95000191	Cable Kit, Round Coil, IN/MO 7000/10000, 2.5-Meter Kit	
	95000241	95000192	Cable Kit, Round Coil, IN/MO 7000/10000, 4.0-Meter Kit (Option)	
	95000242	95000197	Cable Kit, Round Coil, IN/MO 7000/10000, 6.0-Meter Kit (Option)	
7.1	38601151	38601151	Sensor Cable, D-SUB 15pol., 1-meter	
7.2	38602060	38602080	<i>CAN/BUS RJ-45 Cable, 3-meter / UTP</i>	
	38602061	38602081	<i>CAN/BUS RJ-45 Cable, 5-meter / UTP (Option)</i>	
	38602062		<i>CAN/BUS RJ-45 Cable, 7-meter / UTP (Option)</i>	
7.3	94900269	94900240	Induction Coil Connection Cable, IN/MO, 2.5-meter	
	94900284	94900241	Induction Coil Connection Cable, IN/MO, 4.0-meter (Option)	
	94900285	94900242	Induction Coil Connection Cable, IN/MO, 6.0-meter (Option)	

RECOMMENDED STOCK PARTS

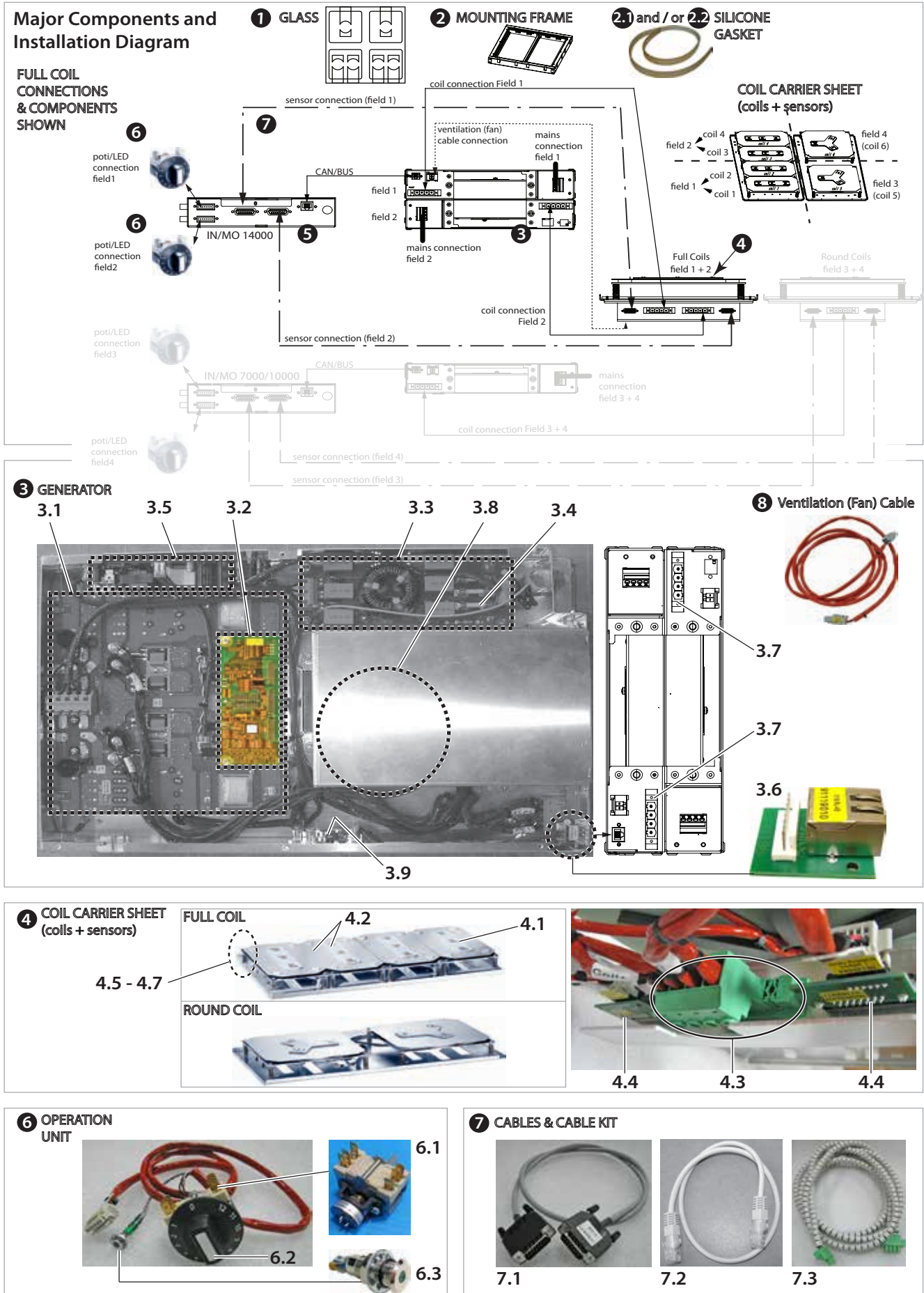

GARLAND PARTS IDENTIFICATION

MO QU 21000 720 208V

MO QU 21000 720 400V

ITEM	208V PART#	400V PART#	DESCRIPTION	CRITICAL
------	------------	------------	-------------	----------

FULL-COIL SECTION COMPONENTS

3	99610347	99610345	Generator, Complete Assembly, IN/MO 14000FL	
3.1	98012661	98012621	Power Module Assembly	C
3.2	91131180	91131200	CPU Board (Print)	
3.3	91168030	91167010	Mains Filter Board (Print)	
3.4	34150259	34150259	Fuse, 25A (Qty=2 per phase)	
3.5	91120032	91120022	Board (Print) I120	
3.6	91119010	91119010	RJ-45 Board (Print) 119	C
3.7	32060406	32060406	Feed-Through Coupling, 4pol. / 16mm ²	
3.8	94090007	94090007	Axial Fan for IN/MO	C
3.9	91109012	91109012	(Print I109c) Supply and CAN-BUS Interface Board	
4	98102650	98102621	Coil Carrier Sheet, Complete Assembly, 3.5kW Full Coil, 354.5 x 689 mm	
4.1	94040090	94040090	Sensor Unit, Full/Rectangular Coil, incl. 3xPT Sensors, 1k	C
4.2	93026150	93026120	Induction Coil and Sensor Assembly (with 3xPT Sensors)	
4.3	32060406	32060406	Feed-through Coupling, 4pol / 16mm ²	
4.4	91161010	91161010	Print/Board I161a, Sub-D, Adapter 90deg.	
4.5	60595006	60595006	Screw	
4.6	73000003	73000003	Spring	
4.7	65840003	65840003	Pin	
5	94030240	94030240	Control Unit Assembly, IN/MO 7000/14000, 208V/400V	C
6	94030040	94030040	Operation IN/MO Assembly, 6pol. (Includes items 6.1, 6.2, 6.3, and cable)	C
6.1	94010001	94010001	Potentiometer with Connector, 2pol, cable not included.	C
6.2	39400001	39400001	Plastic Knob, 0-12	
6.3	35624009	35624009	Front Indicator Lamp 24V LED Green, Chrome	
7	95000245	95000193	Cable Kit, Full Coil, IN/MO 14000, 2.5-Meter Cable Kit	
	95000246	95000194	Cable Kit, Full Coil, IN/MO 14000, 4.0-Meter Cable Kit (Option)	
	95000247	95000195	Cable Kit, Full Coil, IN/MO 14000, 6.0-Meter Cable Kit (Option)	
7.1	38601151	38601151	Sensor Cable, D-SUB 15pol., 1-meter	
	38602060	38602080	CAN/BUS RJ-45 Cable, 3-meter / UTP	
7.2	38602061	38602081	CAN/BUS RJ-45 Cable, 5-meter / UTP (Option)	
	38602062		CAN/BUS RJ-45 Cable, 7-meter / UTP (Option)	
	94900269	94900134	Induction Coil Connection Cable, IN/MO, 2.5-meter	
7.3	94900284	94900132	Induction Coil Connection Cable, IN/MO, 4.0-meter (Option)	
	94900285	94900184	Induction Coil Connection Cable, IN/MO, 6.0-meter (Option)	
8	94900143	94900143	Cable, Fan/Ventilation	

RECOMMENDED STOCK PARTS

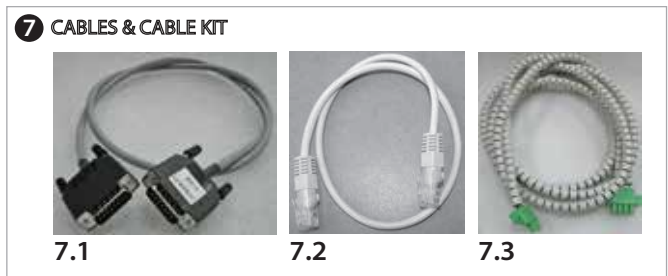
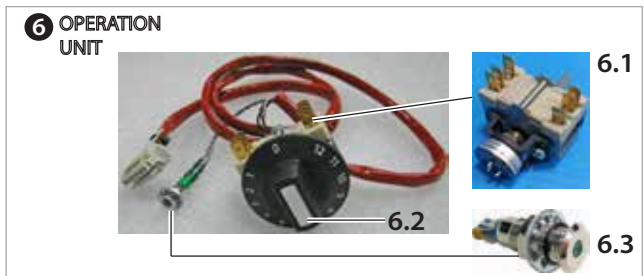
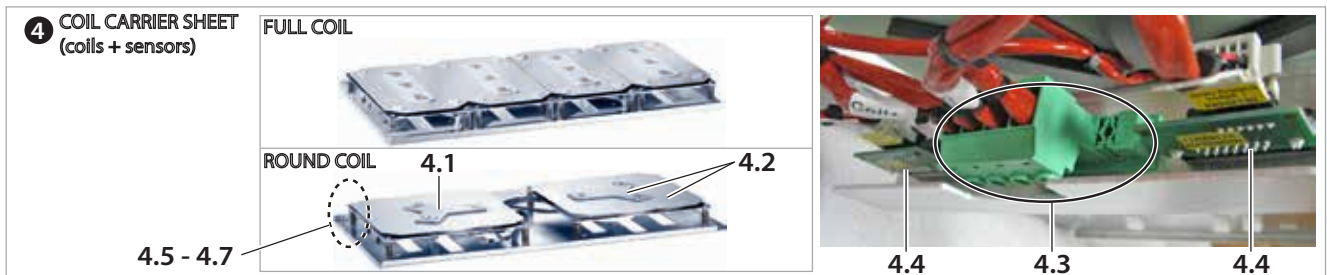
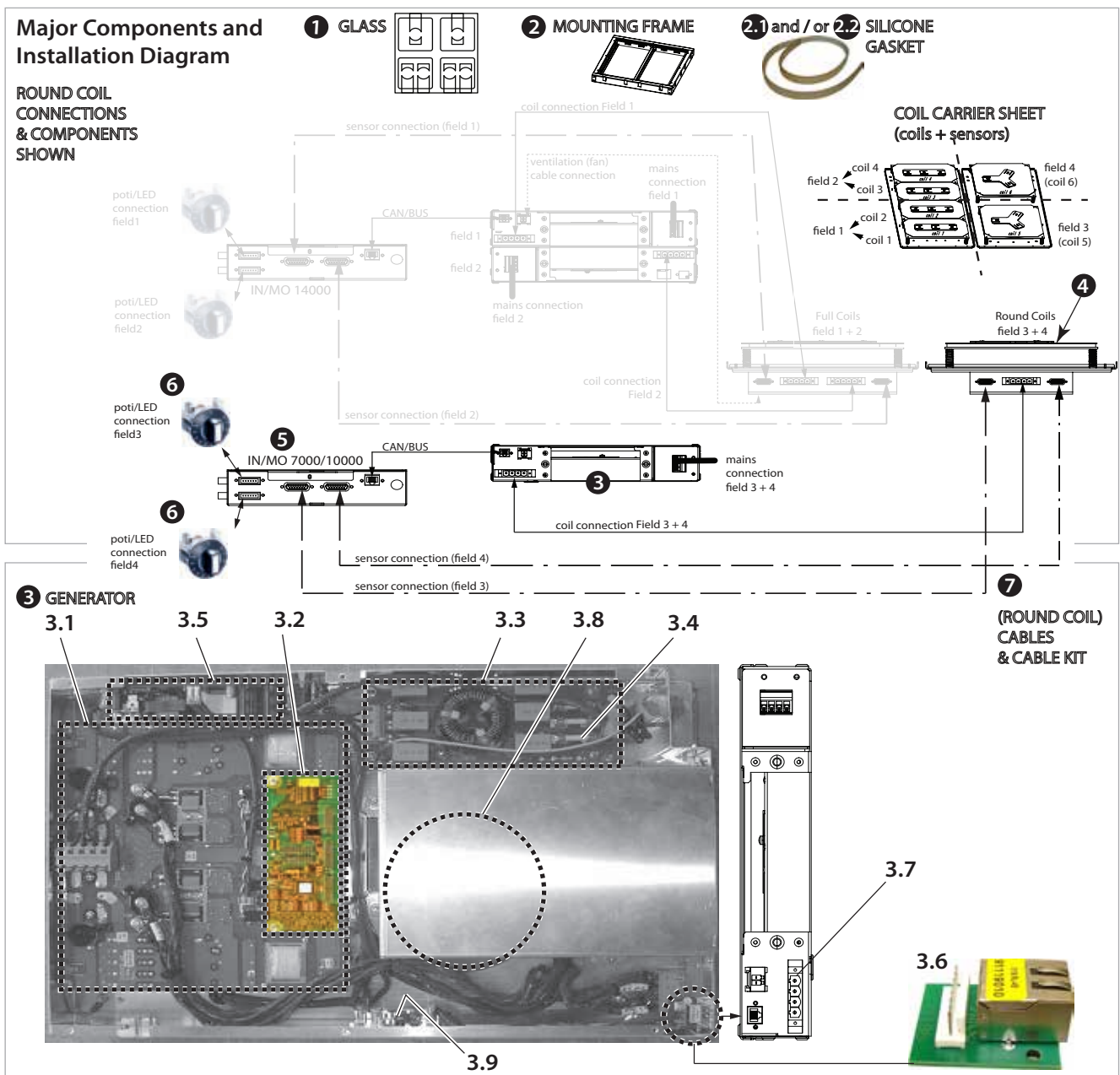

GARLAND PARTS IDENTIFICATION

MO QU 24000 720 208V

MO QU 24000 720 400V

ITEM	208V PART#	400V PART#	DESCRIPTION	CRITICAL
1	77727202	77727202	<i>Ceran Glass-Top, Full+Round Coil, 4-Cookzone, 720x 720x 6mm</i>	
2	95000079	95000079	Mounting Frame for 720x 720mm Glass Size, Incl. Silicone Gaskets	
2.2	70000008	70000008	<i>Silicone Gasket, 710x 12x 3mm</i>	

ROUND-COIL SECTION COMPONENTS

3	99610331	99610330	Generator, Complete Assembly, IN/MO 10000	
3.1	98012661	98012611	Power Module Assembly	C
3.2	91131140	91131160	CPU Board (Print)	
3.3	91168030	91167010	Mains Filter Board (Print)	
3.4	34150259	34150259	Fuse, 25A (Qty=2 per phase)	C
3.5	91120032	91120022	Board (Print) I120	
3.6	91119010	91119010	RJ-45 Board (Print) 119	C
3.7	32060406	32060406	Feed-Through Coupling, 4pol. / 16mm ²	
3.8	94090007	94090007	Axial Fan for IN/MO	C
3.9	91109012	91109012	Board (Print) I109c Supply and CAN Interface	
4	98100514	98101322	Coil Carrier Sheet, Complete Assembly, 5.0kW Round Coil, 354.5 x 689 mm	
4.1	94040130	94040130	Sensor Unit, Round Coil, incl. 3xPT Sensors, 1k	C
4.2	93005090	93013081	Induction Coil and Sensor Assembly (with 3xPT Sensors)	
4.3	32060406	32060406	Feed-through Coupling, 4pol / 16mm ²	
4.4	91162011	91162011	(Print I162a) Sub-D, Adapter Board 90deg.	
4.5	60595006	60595006	Screw	
4.6	73000003	73000003	Spring	
4.7	65840003	65840003	Pin	
5	94030221	94030221	Control Unit Assembly, IN/MO 7000/10000, 208V/400V	C
6	94030040	94030040	Operation IN/MO Assembly, 6pol. (Includes items 6.1, 6.2, 6.3, and cable)	C
6.1	94010001	94010001	Potentiometer with Connector, 2pol, cable not included.	C
6.2	39400001	39400001	Plastic Knob, 0-12	
6.3	35624009	35624009	Front Indicator Lamp 24V LED Green, Chrome	
7	95000240	95000191	Cable Kit, Round Coil, IN/MO 7000/10000, 2.5-Meter Kit	
	95000241	95000192	Cable Kit, Round Coil, IN/MO 7000/10000, 4.0-Meter Kit (Option)	
	95000242	95000197	Cable Kit, Round Coil, IN/MO 7000/10000, 6.0-Meter Kit (Option)	
7.1	38601151	38601151	Sensor Cable, D-SUB 15pol., 1-meter	
	38602060	38602080	CAN/BUS RJ-45 Cable, 3-meter / UTP	
7.2	38602061	38602081	CAN/BUS RJ-45 Cable, 5-meter / UTP (Option)	
	38602062		CAN/BUS RJ-45 Cable, 7-meter / UTP (Option)	
	94900269	94900240	Induction Coil Connection Cable, IN/MO, 2.5-meter	
7.3	94900284	94900241	Induction Coil Connection Cable, IN/MO, 4.0-meter (Option)	
	94900285	94900242	Induction Coil Connection Cable, IN/MO, 6.0-meter (Option)	

RECOMMENDED STOCK PARTS

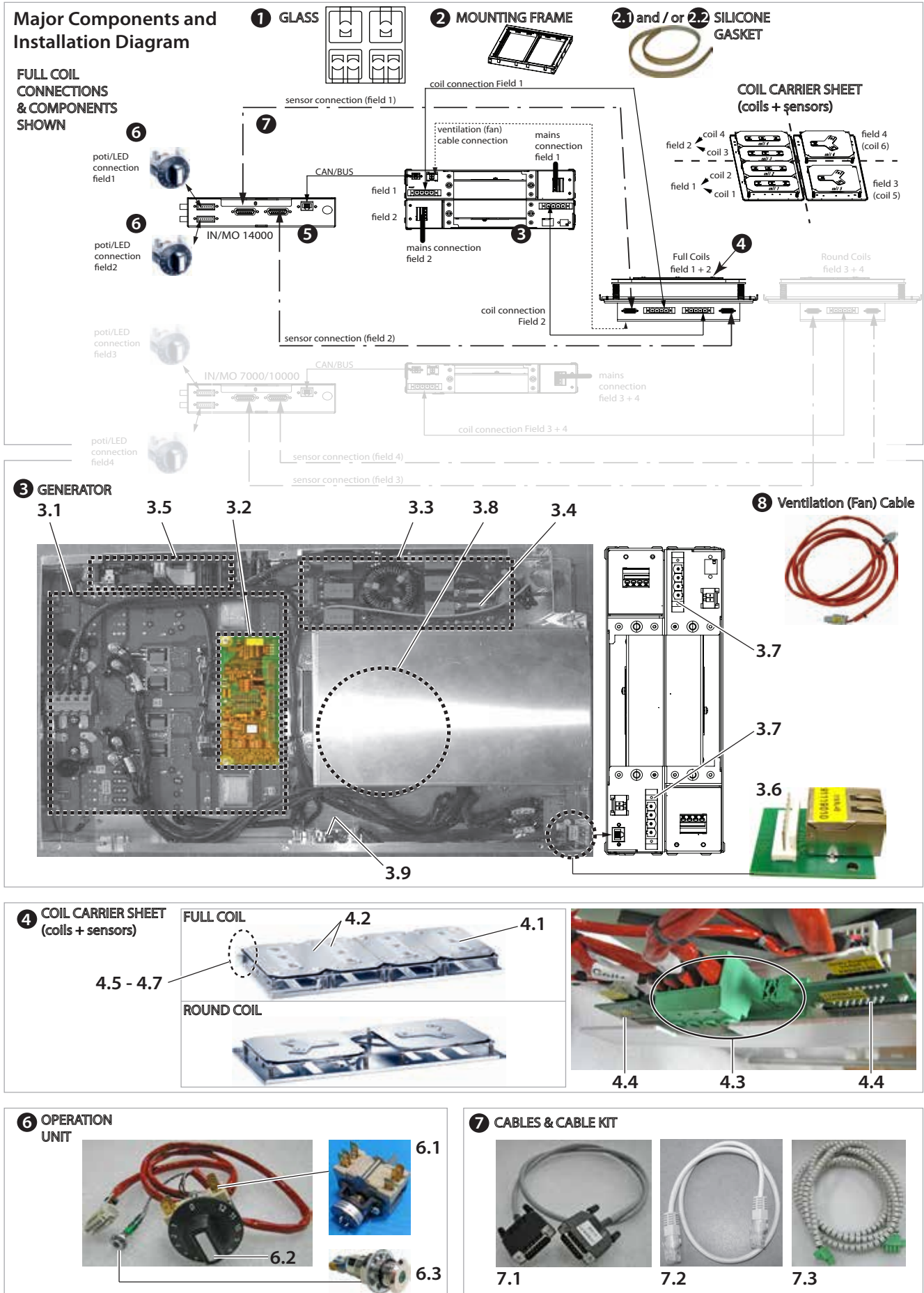

GARLAND PARTS IDENTIFICATION

MO QU 24000 720 208V

MO QU 24000 720 400V

ITEM	208V PART#	400V PART#	DESCRIPTION	CRITICAL
------	------------	------------	-------------	----------

FULL-COIL SECTION COMPONENTS

3	99610347	99610345	Generator, Complete Assembly, IN/MO 14000FL	
3.1	98012661	98012621	Power Module Assembly	C
3.2	91131180	91131200	CPU Board (Print)	
3.3	91168030	91167010	Mains Filter Board (Print)	
3.4	34150259	34150259	Fuse, 25A (Qty=2 per phase)	
3.5	91120032	91120022	Board (Print) I120	
3.6	91119010	91119010	RJ-45 Board (Print) 119	C
3.7	32060406	32060406	Feed-Through Coupling, 4pol. / 16mm ²	
3.8	94090007	94090007	Axial Fan for IN/MO	C
3.9	91109012	91109012	(Print I109c) Supply and CAN-BUS Interface Board	
4	98102650	98102621	Coil Carrier Sheet, Complete Assembly, 3.5kW Full Coil, 354.5 x 689 mm	
4.1	94040090	94040090	Sensor Unit, Full/Rectangular Coil, incl. 3xPT Sensors, 1k	C
4.2	93026150	93026120	Induction Coil and Sensor Assembly (with 3xPT Sensors)	
4.3	32060406	32060406	Feed-through Coupling, 4pol / 16mm ²	
4.4	91161010	91161010	Print/Board I161a, Sub-D, Adapter 90deg.	
4.5	60595006	60595006	Screw	
4.6	73000003	73000003	Spring	
4.7	65840003	65840003	Pin	
5	94030240	94030240	Control Unit Assembly, IN/MO 7000/14000, 208V/400V	C
6	94030040	94030040	Operation IN/MO Assembly, 6pol. (Includes items 6.1, 6.2, 6.3, and cable)	C
6.1	94010001	94010001	Potentiometer with Connector, 2pol, cable not included.	C
6.2	39400001	39400001	Plastic Knob, 0-12	
6.3	35624009	35624009	Front Indicator Lamp 24V LED Green, Chrome	
7	95000245	95000193	Cable Kit, Full Coil, IN/MO 14000, 2.5-Meter Cable Kit	
	95000246	95000194	Cable Kit, Full Coil, IN/MO 14000, 4.0-Meter Cable Kit (Option)	
	95000247	95000195	Cable Kit, Full Coil, IN/MO 14000, 6.0-Meter Cable Kit (Option)	
7.1	38601151	38601151	Sensor Cable, D-SUB 15pol., 1-meter	
	38602060	38602080	CAN/BUS RJ-45 Cable, 3-meter / UTP	
7.2	38602061	38602081	CAN/BUS RJ-45 Cable, 5-meter / UTP (Option)	
	38602062		CAN/BUS RJ-45 Cable, 7-meter / UTP (Option)	
	94900269	94900134	Induction Coil Connection Cable, IN/MO, 2.5-meter	
7.3	94900284	94900132	Induction Coil Connection Cable, IN/MO, 4.0-meter (Option)	
	94900285	94900184	Induction Coil Connection Cable, IN/MO, 6.0-meter (Option)	
8	94900143	94900143	Cable, Fan/Ventilation	

RECOMMENDED STOCK PARTS

GARLAND INDUCTION PRODUCTS
REPAIR ACCESSORIES FOR SERVICE TECHNICIANS

PHOTO	PART #	DESCRIPTION
	98990001	<i>IR Adapter</i>
	70000020	Heat Conducting Paste P12
	94900096	<i>Short Circuit (Service) Plug (RTCS only, Not for RTCSmp)</i>
	39800001	USB- RS232 Adapter
(PHOTO UNAVAILABLE)	70000022	High Temperature Tape
RECOMMENDED STOCK PARTS		

CRITICAL AND RECOMMENDED STOCK PARTS LIST
Garland Induction Module-Line Dual And Quad Cooktops







208V PART#	400V PART#	DESCRIPTION	R	C
GLASS				
77363601	77363601	Ceran Glass-Top, Round Coil, 1-Cookzone, 360x 360x 6mm	R	
77376501	77376501	Ceran Glass-Top, Round Coil, 2-Cookzone, 375x 650x 6mm	R	
77367201	77367201	Ceran Glass-Top, Round Coil, 2-Cookzone, 360x 720x 6mm	R	
77656501	77656501	Ceran Glass-Top, Round Coil, 4-Cookzone, 650x 650x 6mm	R	
77727201	77727201	Ceran Glass-Top, Round Coil, 4-Cookzone, 720x 720x 6mm	R	
77363602	77363602	Ceran Glass-Top, Full Coil, 1-Cookzone, 360x 360x 6mm	R	
77376502	77376502	Ceran Glass-Top, Full Coil, 2-Cookzone, 375x 650x 6mm	R	
77367202	77367202	Ceran Glass-Top, Full Coil, 2-Cookzone, 360x 720x 6mm	R	
77656502	77656502	Ceran Glass-Top, Full Coil, 4-Cookzone, 650x 650x 6mm	R	
77727203	77727203	Ceran Glass-Top, Full Coil, 4-Cookzone, 720x 720x 6mm	R	
77727202	77727202	Ceran Glass-Top, Full + Round Coil, 4-Cookzone, 720x 720x 6mm	R	
SILICONE GASKET (FOR GLASS INSTALLATION)				
70000007	70000007	Silicone Gasket, 350x 12x 3mm	R	
70000008	70000008	Silicone Gasket, 710x 12x 3mm	R	
GENERATOR COMPONENTS				
98012661	98012611	Power Module Assembly, in IN/MO 7000 and IN/MO 10000	R	C
98012661	98012621	Power Module Assembly, in IN/MO 7000FL and IN/MO 14000FL	R	C
34150259	34150259	Fuse, 25A (Qty=2 per phase)	R	C
91120032	91120022	Board (Print) I120	R	
91119010	91119010	RJ-45 Board (Print) 119	R	C
94090007	94090007	Axial Fan for IN/MO	R	C
91109012	91109012	(Print I109c) Supply and CAN-BUS Interface Board	R	
COIL CARRIER SHEET COMPONENTS				
94040130	94040130	Sensor Unit, Round Coil, incl. 3xPT Sensors, 1k	R	C
94040090	94040090	Sensor Unit, Full/Rectangular Coil, incl. 3xPT Sensors, 1k	R	C
91161010	91161010	Print/Board I161a, Sub-D, Adapter 90deg.	R	
CONTROL UNIT ASSEMBLY				
94030221	94030221	Control Unit Assembly, IN/MO 7000/10000, 208V/400V	R	C
94030240	94030240	Control Unit Assembly, IN/MO 7000/14000, 208V/400V	R	C
OPERATION UNIT				
94030040	94030040	Operation IN/MO Assembly, 6pol.		C
94010001	94010001	Potentiometer with Connector, 2pol, cable not included.	R	C
35624009	35624009	Front Indicator Lamp 24V LED Green, Chrome	R	
CABLES				
38602060	38602080	CAN/BUS RJ-45 Cable, 3-meter / UTP	R	
38602061	38602081	CAN/BUS RJ-45 Cable, 5-meter / UTP (Option)	R	
38602062	-	CAN/BUS RJ-45 Cable, 7-meter / UTP (Option)	R	
SERVICE REPAIR ACCESSORIES				
94900096	94900096	Short Circuit (Service) Plug (RTCS only, Not for RTCSmp)	R	

R = Recommended Stock Parts
C = Critical Parts

REFERENCE GUIDE: LIST OF MODULE-LINE DUAL & QUAD COMPONENTS AND FEATURES

Each built-in Module-Line unit is composed of at least one of each of the following components:

1. induction generator
2. control unit
3. operation unit with rotary switch
4. 6mm thick Ceran glass-top
5. coil carrier sheet with built-in induction coil and sensor assemblies
6. mounting frame, and
7. cables.

FEATURES	ILLUSTRATION	PART#	DESCRIPTION
1. INDUCTION GENERATOR: Can be installed up to 10 feet away from other components. All electrical connections can be accessed externally through plug connections. Closed aluminum housing with an integrated cooling fan to keep electronics cool. Integrated air guiding system to direct exhaust air out of the housing. Four (4) versions are available: <ul style="list-style-type: none"> • IN/MO 7000 • IN/MO 10000 • IN/MO 7000FL • IN/MO 14000FL 		99610321	IN/MO 7000 208V, 7kW, 3Ph, 22A
		99610326	IN/MO 7000FL 208V, 7kW, 3Ph, ?A
		99610331	IN/MO 10000 208V, 10kW, 3Ph, 30A
		99610347	IN/MO 14000FL 208V, 14kW, 3Ph, 30A
		99610320	IN/MO 7000 400V, 7kW, 3Ph, 10A
		99610325	IN/MO 7000FL 400V, 7kW, 3Ph, 10A
		99610330	IN/MO 10000 400V, 10kW, 3Ph, 15A
	99610345	IN/MO 14000FL 400V, 14kW, 3Ph, 20A	
2. CONTROL UNIT: Information and diagnostic hub for the whole induction unit. IR interface with diagnostic system for service. Connections to other unit components via plug connections. Compact design and easy to install using special installation tabs/brackets. Two (2) versions are available: <ul style="list-style-type: none"> • IN/MO 7000/14000 • IN/MO 7000/10000 		94030221	IN/MO 7000/10000, 208V / 400V
		94030240	IN/MO 7000/14000, 208V / 400V
3. OPERATING UNIT The power switch (Operation Unit) regulates the temperature in power levels 1 to 12. Simple to operate; adjust the temperature setting simply by turning the knob. LED light indicator (not shown) signals the ON/OFF state, pan detection process and error codes. Pre-assembled with plastic knob, LED light and cable.		94030040	Switch Assembly, Operation IN/MO, 6pol. (Includes a plastic knob, a green LED lamp, potentiometer, and cable-1 meter)



REFERENCE GUIDE: LIST OF MODULE-LINE DUAL & QUAD COMPONENTS AND FEATURES (CONT.)

4. CERAN GLASS-TOP AND FEAUTES

6mm thick Ceran glass-top. | Easy to clean and maintain. | Three glass-top patterns available: Full-Coil / Round-Coil/ Round and Full Coil Quad:

Available sizes:

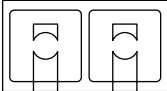
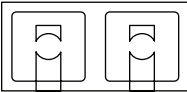
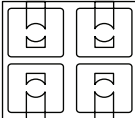
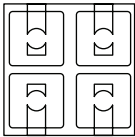
- Dual: 360x 360x 6mm; 650x 375x 6mm; 720x 360x 6mm
- Quad: 650x 650x 6mm; 720x 720x 6mm

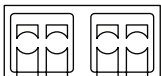
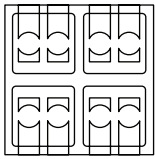
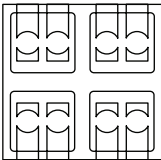
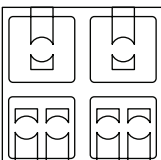

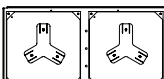
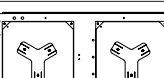
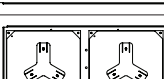
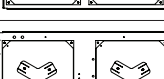



ILLUSTRATION	PART#	DESCRIPTION
	77363601	Ceran Glass-Top, Round Coil, 1-Cookzone, 360x 360x 6mm
	77376501	Ceran Glass-Top, Round Coil, 2-Cookzone, 375x 650x 6mm
	77367201	Ceran Glass-Top, Round Coil, 2-Cookzone, 360x 720x 6mm
	77656501	Ceran Glass-Top, Round Coil, 4-Cookzone, 650x 650x 6mm
	77727201	Ceran Glass-Top, Round Coil, 4-Cookzone, 720x 720x 6mm
	77363602	Ceran Glass-Top, Full Coil, 1-Cookzone, 360x 360x 6mm
	77376502	Ceran Glass-Top, Full Coil, 2-Cookzone, 375x 650x 6mm
	77367202	Ceran Glass-Top, Full Coil, 2-Cookzone, 360x 720x 6mm
	77656502	Ceran Glass-Top, Full Coil, 4-Cookzone, 650x 650x 6mm
	77727203	Ceran Glass-Top, Full Coil, 4-Cookzone, 720x 720x 6mm
	77727202	Ceran Glass-Top, Full + Round Coil, 4-Cookzone, 720x 720x 6mm

REFERENCE GUIDE: LIST OF MODULE-LINE DUAL & QUAD COMPONENTS AND FEATURES (CONT.)

5. COIL CARRIER SHEET (COILS & SENSORS) AND FEATURES

Multiple options are available: round or full coil in single, dual, or quad configurations. | Compact and low profile design.



- Full Coil (FL): Rectangular in shape. Several large or small pans can be placed on one surface at the same time.
- Round Coil: Circular in shape. One pan is used for each heat-zone. Round coils have higher power density and energy efficiency.

ILLUSTRATION	PART#		DESCRIPTION
	208V MODEL	400V MODEL	
	98100515	98101220	1-Round Coil, 3.5kW, 344x 355 mm
	98100516	98101323	1-Round Coil, 5.0kW, 344x 355 mm
	98100517	98101219	2-Round Coils, Each 3.5kW, 319x 624 mm
	98100513	98101218	2-Round Coils, Each 3.5kW, 354.5x 689 mm
	98100518	98101330	2-Round Coils, Each 5.0kW, 319x 624 mm
	98100514	98101322	2-Round Coils, Each 5.0kW, 354.5x 689 mm
	98102670	98102641	2-Full Coils, Each 3.5kW, 344 x 355 mm
	98102660	98102631	4-Full Coils, Each 3.5kW, 319x 624 mm
	98102650	98102621	4-Full Coils, Each 3.5kW, 354.5x 689 mm

REFERENCE GUIDE: LIST OF MODULE-LINE DUAL & QUAD COMPONENTS AND FEATURES (CONT.)

6. MOUNTING FRAME AND FEATES

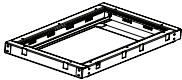
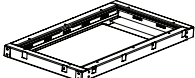
Installation/mounting frame is supplied for flush mounting the coil carrier sheet(s) and glass-top. | Silicone gaskets (not shown) for installation are included. Five sizes are available:

ILLUSTRATION	PART#	DESCRIPTION
	95000075	Mounting Frame for 360x 360mm Glass Size, Dual Models
	95000076	Mounting Frame for 375x 650mm Glass Size, Dual Models
	95000078	Mounting Frame for 360x 720mm Glass Size, Dual Models
	95000077	Mounting Frame for 650x 650mm Glass Size, Quad Models
	95000079	Mounting Frame for 720x 720mm Glass Size, Quad Models

7. LIST OF CABLE KITS

A cable kit includes a coil cable, sensor cable and RJ-45 CAN-BUS cable. Cable for the internal fan is included where applicable. See the parts list tables that followed for the part numbers of the individual cables.

208V	400V	DESCRIPTION	LENGTH OF COIL CABLE (METER)
95000185	95000180	Round Coil, IN/MO 7000/10000-360	2.5
95000186	95000181	Round Coil, IN/MO 7000/10000-360	4.0
95000187	95000182	Round Coil, IN/MO 7000/10000-360	6.0
95000240	95000191	Round Coil, IN/MO 7000/10000	2.5
95000241	95000192	Round Coil, IN/MO 7000/10000	4.0
95000242	95000197	Round Coil, IN/MO 7000/10000	6.0
95000245	95000193	IN/MO 14000	2.5
95000246	95000194	IN/MO 14000	4.0
95000247	95000196	IN/MO 14000	6.0
95000255	95000220	IN/MO 7000FL -360	2.5
95000256	95000221	IN/MO 7000FL -360	4.0
95000257	95000222	IN/MO 7000FL -360	6.0

Revision History (MO DU / MO QU)

REV	PAGE#	ITEM#	NOTES	DATE	WRITER
0			New Release	4 APR/14	HH



Induction Module-Line Dual and Quad Cooktops — MODU & MOQU Models Parts List

Garland Commercial Ranges, Ltd.
1177 Kamato Road
Mississauga, Ontario L4W 1X4 Canada
www.Garland-Group.com

Parts & Service
1 800 427 6668 (Phone, US & Canada)
1 800 361 7745 (Fax, US & Canada)

