



SERVICE MANUAL

GARLAND GAS & ELECTRIC
CLAMSHELL GRILLS
WITH PRODUCT RECOGNITION

MODELS:

MWE3W

MWE3S

MWG3W



WARNING:

IMPROPER INSTALLATION, ADJUSTMENT, ALTERATION, SERVICE OR MAINTENANCE CAN CAUSE PROPERTY DAMAGE, INJURY OR DEATH. READ THE INSTALLATION, OPERATING AND MAINTENANCE INSTRUCTIONS THOROUGHLY BEFORE INSTALLING OR SERVICING THIS EQUIPMENT.

PLEASE READ ALL SECTIONS OF THIS MANUAL AND RETAIN FOR FUTURE REFERENCE.

THIS EQUIPMENT MUST BE INSTALLED AND COMMISSIONED BY A PROFESSIONAL,
FACTORY-TRAINED TECHNICIAN.

THIS EQUIPMENT MUST BE OPERATED UNDER AN APPROVED EXHAUST HOOD SYSTEM ONLY.

NOTE: This manual pertains to all grill models listed above. The reader/operator must interpret its contents to applicable needs. If you have questions about any instructional materials pertaining to Garland grills, please contact our Customer Service Department at one of the phone numbers below.

MANUFACTURED EXCLUSIVELY FOR McDonald's BY
GARLAND COMMERCIAL INDUSTRIES, LLC
185 EAST SOUTH STREET FREELAND, PENNSYLVANIA 18224
TOLL FREE: (800) 446-8367 PHONE: (570) 636-1000 FAX: (570) 636-9874
E-mail: clamshell@garland-group.com
<http://www.garland-group.com>

CONTENTS

INTRODUCTION	4	COMMON PRODUCT RECOGNITION ISSUES	26
WARRANTY	4	PATTY PLACEMENT	27
SAFETY	5	BEEF INTEGRITY	28
SHIPPING DAMAGE CLAIM PROCEDURE	6	CONTROL PROGRAMMING	29
CLEANING & MAINTENANCE	6	Programming Modes; System Setup	29
SPECIFICATIONS	8	Programming Modes; Menu Items.....	30
Dimensions: Model MWE3S.....	9	To Restore Factory Defaults	32
Input Specifications, Electric Grills, United States:	10	PROGRAM LOGIC TREE; PRODUCT MENUS	33
Input Specifications, Electric Grills, Canada:	10	PROGRAM LOGIC TREE; SYSTEM MENUS	34
Input Specifications, Electric Grills, CE Approved	10	FUNCTION OPTIONS; SYSTEM MENU	35
Input Specifications, Electric Grills, Export, Non-CE	10	FACTORY DEFAULT SETTINGS	36
Input Specifications, GAS Grills, North America:	11	ERROR MESSAGES/TROUBLESHOOTING	37
INSTALLATION & STARTUP	12	PROBE CALIBRATION	39
Uncrating the unit	13	THERMOCOUPLE LOCATIONS	39
Electrical Cord Hookup.....	14	PLATEN LEVELING (ZEROING)	40
Exhaust hood Type & Platen Height.....	15	TO SET THE REED SWITCHES	41
Startup Procedure	16	TO CHANGE THE REED SWITCH	41
Setting the Proper Combustion levels.....	17	REED SWITCH OPERATION	42
INSTALLATION OF WRAP AROUND RELEASE MATERIAL		TO CHANGE THE MAGNET ASSEMBLY	45
MOUNTING BRACKETS	18	TO REPLACE THE LINEAR ACTUATOR	45
INSTALLATION OF SPLASH SHIELD	18	TO UPDATE CONTROL SOFTWARE (main control)	47
INSTALLATION OF RELEASE MATERIAL	19	TO UPDATE CONTROL SOFTWARE (motor control)	48
INSTALLATION OF VAPOR SHIELD	19	FLEXIBLE GAS LINE REPLACEMENT	49
ACCESSORIES	20	GRILL EXTERIOR; ALL MODELS.....	52
Splash Shield	20	GRILL EXTERIOR; ALL MODELS.....	53
Vapor Shield	20	GRILL ELEMENT; ELECTRIC MODELS.....	54
Teflon Wraparound kits.....	20	GRILL ELEMENT; ELECTRIC MODELS.....	55
Quick Disconnect Gas Hose	21	GRILL BURNER; GAS MODELS.....	56
Interlock Cord - 5-Wire	21	GRILL BURNER; GAS MODELS.....	57
3Phase 4Wire 50 AMP Cord.....	21	UPPER PLATEN ASSEMBLY; ALL MODELS	58
3Phase 4 Wire 30 AMP Cord	21	UPPER PLATEN ASSEMBLY; ALL MODELS	59
DESCRIPTION OF GRILL CONTROL	22	PLATEN LIFTING MECHANISM; ALL MODELS.....	60
POSSIBLE ERROR MESSAGES	22	PLATEN LIFTING MECHANISM; ALL MODELS.....	61
OPERATING PROCEDURES	23	PARTS ID: WIRING HARNESSSES; ALL MODELS	62
General Overview:	23	WIRING SCHEMATICS	65
To turn the grill on:.....	23	120V CONTROL CIRCUIT; MWG3W	65
To Select a Menu item:	23	120V CONTROL CIRCUIT; MWE3W	65
Menu Item Library	23	MWE3W 200/208/220/240V, 60Hz	66
Indicator Lights	24	MWE3W 3~N, 400V, 50Hz.....	67
Standby Mode	24	MWG3W 200/208/220/240V, 60Hz.....	68
To display the current temperatures:.....	24	MWG3W 3~N, 400V, 50Hz	69
Breakfast In Manual mode.....	24	INDEX	70
Lunch In Manual mode.....	24		
To Change The Cook Time for a Menu Item.....	24		
Breakfast In Auto mode	24		
Lunch In Auto mode	25		
Transition Cooking.....	25		
PRODUCT RECOGNITION	25		
TO PERFORM FORCED AUTO CALIBRATION.....	25		

INTRODUCTION

The Garland clamshell grill, manufactured exclusively for McDonald's, provides a method for efficient two-sided cooking, while accommodating a variety of products. The unit will also serve as a flat grill, and meets all of McDonald's standards for safety, efficiency, and cleanliness.

WARRANTY

This warranty covers defects in material and workmanship under normal use providing that:

- a) the equipment has not been accidentally or intentionally damaged, altered or misused.
- b) the equipment is properly installed, adjusted, operated and maintained in accordance with national and local codes and in accordance with the installation instructions provided with this product.
- c) the warranty serial number affixed to the appliance by us has not been defaced, obliterated or removed.
- d) an acceptable report for any claim under this warranty is supplied to us.

The equipment warranty coverage remains in force for two (2) years, (parts and labor), from the date the equipment is put into operation.

The Garland Group agrees to repair or replace, at it's option, any part that proves to be defective in material or workmanship at no charge for the part or normal labor.

We assume no responsibility for installation, adjustments, diagnosis, or normal maintenance such as: lubrication of springs or valves. We exclude failures caused by erratic voltage or gas supplies.

We assume no responsibility for travel costs beyond 100 miles round trip, travel other than overland, and overtime costs of repair.

We exclude broken glass, paint and porcelain finish, surface rust, gasket material, ceramic material, light bulbs and fuses from normal coverage.

We exclude damage or dysfunction caused by fire, flood, and like "Acts of God" that are beyond the control of The Garland Group.

The Garland Group's liability on a claim of warranty shall not exceed the price of the material and/or service, which caused the claim.

This warranty is limited and is in lieu of all other warranties, expressed or implied. The Garland Group, our employees, or our agents shall not be held liable for any claims of personal injury or consequential damage or loss.

This warranty gives you specific legal rights, and you may have other rights which vary from state to state.

SAFETY

THIS APPLIANCE IS FOR PROFESSIONAL USE AND SHALL BE USED ONLY BY QUALIFIED PERSONNEL.

WARNING: Accessible parts may become hot during use. Young children should be kept away. This appliance is not intended for use by persons (including children) with reduced physical, sensory or mental capabilities, or lack of experience and knowledge, unless they have been given supervision or instruction concerning use of the appliance by a person responsible for their safety."

CAUTION: THIS EQUIPMENT MUST ONLY BE OPERATED UNDER AN APPROVED HOOD SYSTEM IN ACCORDANCE WITH LOCAL REGULATIONS IN FORCE.

DO NOT OPERATE THE GRILL UNLESS IT HAS BEEN COMMISSIONED (START-UP) BY A FACTORY AUTHORIZED SERVICE CENTER.

DO NOT operate the grill without reading this operation manual.

DO NOT operate the clamshell grill unless it has been properly installed and grounded.

DO NOT operate the clamshell grill unless all service and access panels are in place and fastened properly.

Means of disconnection, must be incorporated in the fixed wiring in accordance with local wiring rules (such as a switch, fuse, or circuit breaker). External equipotential bonding conductor provided on rear of appliance. Use as applicable, in accordance with local wiring rules.

The Garland clamshell grill is a semi-automatic cooking appliance. The upper platen is lowered automatically, following the manual, single-handed initiation of the cooking cycle, and raised automatically upon completion of the cooking cycle.

When two sided cooking, the area between the upper platen and the griddle plate should be regarded as a "danger zone". During two sided cooking the operator must not be within this danger zone. When used as a flat grill, then this area is no longer a danger zone, the platens do not move. For whatever reason, be it cleaning, maintenance, normal operation, any exposed person must use extreme caution if within this danger zone. Temperatures on solid cooking surfaces are intended to operate above 120C (250F).

In two sided cooking the upper platen remains in the lowered position by nature of it's own weight. It is not locked down. It can be raised by lifting of the handle on the front of the platen, which pivots the platen about its rear mounting point.

The clamshell grill must only be used for single and two sided cooking of foodstuffs in a McDonald's store.

WARNING: To avoid serious personal injury: **DO NOT** attempt to repair or replace any part of the clamshell grill unless all main power supplies to the grill have been disconnected.

USE EXTREME CAUTION in setting up, operating and cleaning the clamshell grill to avoid coming in contact with hot grill surfaces or hot grease. Suitable protective clothing should be worn to prevent the risk of burns.

WARNING: This appliance must not be cleaned with a water jet. **DO NOT** apply ice to a HOT grill surface.

NOTE: All warning labels and markings on the grill, which call attention to further dangers and necessary precautions.

HAZARD COMMUNICATION STANDARD, (HCS) - The procedures in this manual include the use of chemical products. These chemical products will be printed in **bold face**, followed by the abbreviation **(HCS)** in the text portion of the procedure. See the Hazard Communication Standard, (HCS) manual for the appropriate Material Safety Data Sheet(s), (MSDS).

WARNING: After turning the master power switch to the START position, the grill will go through an initialization process. If the upper platens are in the lowered position they will return to their raised upper position.

MAINTENANCE - the platen support arms carriage block bearing bushes, the platen adjuster nuts, the platen support (shoulder) bolt and the cam follower should be checked annually for wear. Should there be any noticeable play in the bearing bushes and any visible wear on the platen adjuster nuts, platen support bolts or cam follower, then they must be replaced.

MAINTENANCE - the audible alarm that sounds at the end of a cook cycle is to advise the operator that the platen is about to move. The function of this device may be tested by pushing the left hand CANCEL button. If no sound is heard, ensure that the alarm volume is not set to low in SYSTEM SETUP. If there is still no sound then a service engineer should be called out to rectify the fault.

SERVICE AND CLEANING - The grill may be secured in the grill bay by the installer using two anchors that lock onto the front casters. If the grill is to be moved out of the bay for cleaning or service, remove the anchor from each caster by turning the knob counterclockwise to loosen the retainer. When the retainer is free of the caster, lay the assembly aside on the floor.

CLEANING - NEVER clean the grill, interior or exterior, using a high-pressure sprayer, water jet, or any other liquid sprayer.

NOTE: If anchors are present, the anchor assembly remains fastened to the back wall of the grill bay. After service or cleaning is complete, return the grill to its position in the bay and reattach the anchors by placing the retainer on the caster post and turning the knob clockwise to tighten. For safety reasons, the grill must be secured in the grill bay in this manner before operation can resume.

SHIPPING DAMAGE CLAIM PROCEDURE

Please note that the Garland equipment was carefully inspected and packed by skilled personnel before leaving the factory. The transportation company assumes full responsibility for safe delivery upon acceptance of the equipment. What to do if the equipment arrives damaged:

1. File a claim immediately regardless of the extent of damage.
2. Be sure to note, "visible loss or damage," on the freight bill or express receipt and have the person making the delivery sign it.
3. Concealed loss or damage: if damage is unnoticed until the equipment is unpacked, notify the freight company immediately, (within 15 days), and file a concealed damage claim.

CLEANING & MAINTENANCE



McD Hi-Temp Grill Cleaner

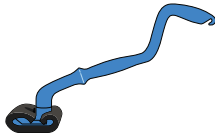

KAY Grill Cleaning Pad Holder & KAY Grill Cleaning Pad

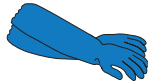

Heat-Resistant Gloves



Clean, Sanitizer-Soaked Grill Cloths



Lid

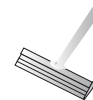



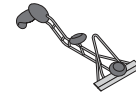

Grill Squeegee

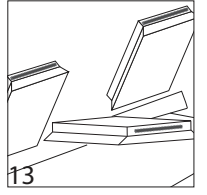
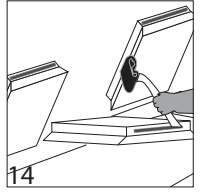
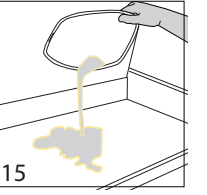
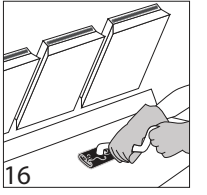
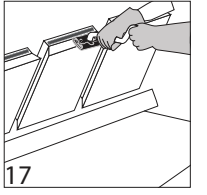
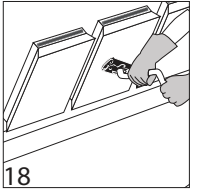
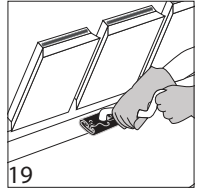
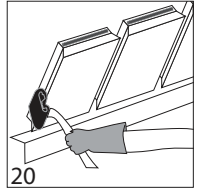
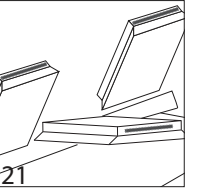
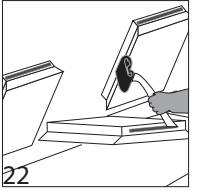
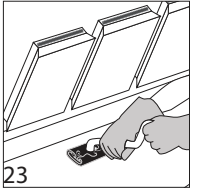
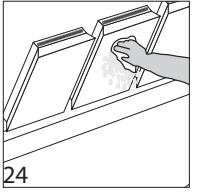
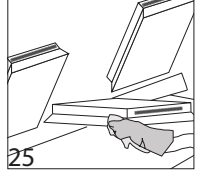
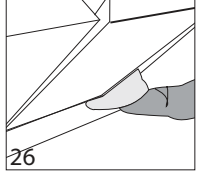
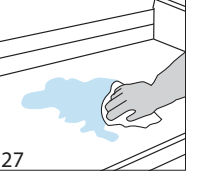
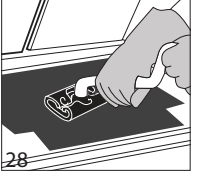

Grill Scraper

<p>1</p>	<p>2</p>	<p>3</p>	<p>4</p>	<p>5</p>	<p>6</p>
<ul style="list-style-type: none"> • Select Clean Mode. Once Clean Mode has been reached turn grill OFF. • After turning grill OFF, platens can be controlled by pressing green button 	<ul style="list-style-type: none"> • Wipe the Release Material® sheets with a clean, sanitizer-soaked grill cloth. 	<ul style="list-style-type: none"> • Remove the locking clips, bars, and release sheets. • Take the clips and bars to the 3-compartment sink to be washed and rinsed; set aside. • Set release sheets aside on a flat surface. 	<ul style="list-style-type: none"> • If splash guards are installed, detach and take to the 3-compartment sink to be washed and rinsed; set aside. 	<ul style="list-style-type: none"> • Scrape the lower grill surface with the grill scraper. • Use grill squeegee to push residual grease into trough. • Take grill scraper to the 3-compartment sink to be washed and rinsed. 	<ul style="list-style-type: none"> • Empty and replace the grease troughs.
<p>7</p>	<p>8</p>	<p>9</p>	<p>10</p>	<p>11</p>	<p>12</p>
<ul style="list-style-type: none"> • Open one packet of McD Hi-Temp Grill Cleaner and empty the contents into a lid or stainless steel pan. • Put on the heat-resistant gloves. 	<ul style="list-style-type: none"> • Dip the KAY Grill Cleaning Pad Holder into the grill cleaner. 	<ul style="list-style-type: none"> • Apply McD Hi-Temp Grill Cleaner to front side of platens starting from right platen to left platen. • DO NOT SCRUB 	<ul style="list-style-type: none"> • Apply the grill cleaner to platen surfaces starting from right platen to left platen. • DO NOT SCRUB 	<ul style="list-style-type: none"> • Apply the grill cleaner to back side of platens from right platen to left platen. • DO NOT SCRUB 	<ul style="list-style-type: none"> • Apply the grill cleaner to outer edges of right and left platens. • DO NOT SCRUB

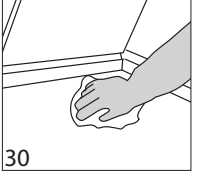
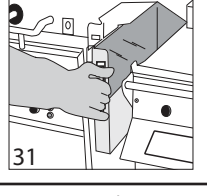
CLEANING & MAINTENANCE *continued*

 <p>13</p>	 <p>14</p>	 <p>15</p>	 <p>16</p>	 <p>17</p>	 <p>18</p>
<ul style="list-style-type: none"> • Press green button to lower center platen. 	<ul style="list-style-type: none"> • Apply grill cleaner to inner edges of the right and left platens. • DO NOT SCRUB • Press green button to raise center platen. 	<ul style="list-style-type: none"> • Pour remaining McD Hi-Temp Grill Cleaner over bottom grill surface. 	<ul style="list-style-type: none"> • Spread the cleaner over the entire lower grill surface from front to back using even strokes. • DO NOT SCRUB 	<ul style="list-style-type: none"> • Scrub front side of platens from right platen to left platen with KAY Grill Cleaning Pad Holder and Pad. 	<ul style="list-style-type: none"> • Scrub flat grill surfaces starting from right platen to left platen.
 <p>19</p>	 <p>20</p>	 <p>21</p>	 <p>22</p>	 <p>23</p>	 <p>24</p>
<ul style="list-style-type: none"> • Scrub back side of platens from right platen to left platen. 	<ul style="list-style-type: none"> • Scrub outer edges of right and left platens. 	<ul style="list-style-type: none"> • Press green button to lower center platen. 	<ul style="list-style-type: none"> • Scrub inner edges of the right and left platens. • Press green button to raise the right platen. 	<ul style="list-style-type: none"> • Scrub lower grill surface. 	<ul style="list-style-type: none"> • Rinse front, side and back of platen surfaces with a clean, sanitizer-soaked grill cloth, starting from right to left platens.
 <p>25</p>	 <p>26</p>	 <p>27</p>	 <p>28</p>	 <p>29</p>	 <p>30</p>
<ul style="list-style-type: none"> • Press the green button to lower right platen, rinse inner edges of both platens; then, raise. 	<ul style="list-style-type: none"> • Wipe back of lower grill with a clean, sanitizer-soaked grill cloth. 	<ul style="list-style-type: none"> • Pour a small amount of lukewarm water on a clean, sanitizer-soaked grill cloth over the bottom grill surface and wipe off residue. 	<ul style="list-style-type: none"> • Place upper platen Release Material sheets flat on grill surface. • Gently clean both sides of the Release Material sheets with the KAY Grill Cleaning Pad Holder. 	<ul style="list-style-type: none"> • Rinse both sides of the Release Material sheets with a clean, sanitizer-soaked grill cloth. • Reinstall upper Release Material sheets; secure in place with bars and clips. 	<ul style="list-style-type: none"> • Wipe lower grill with a clean, sanitizer-soaked grill cloth. Repeat until no visible soil remains.
 <p>31</p>	 <p>32</p>	 <p>33</p>			
<ul style="list-style-type: none"> • Empty, wash, rinse, and replace the grease troughs. 	<ul style="list-style-type: none"> • Wipe remaining grill surfaces with a clean, sanitizer-soaked grill cloth. 	<ul style="list-style-type: none"> • Apply a thin coat of fresh shortening to the lower grill surface only. 			

SPECIFICATIONS

Dimensions: Models MWE3W, MWG3W

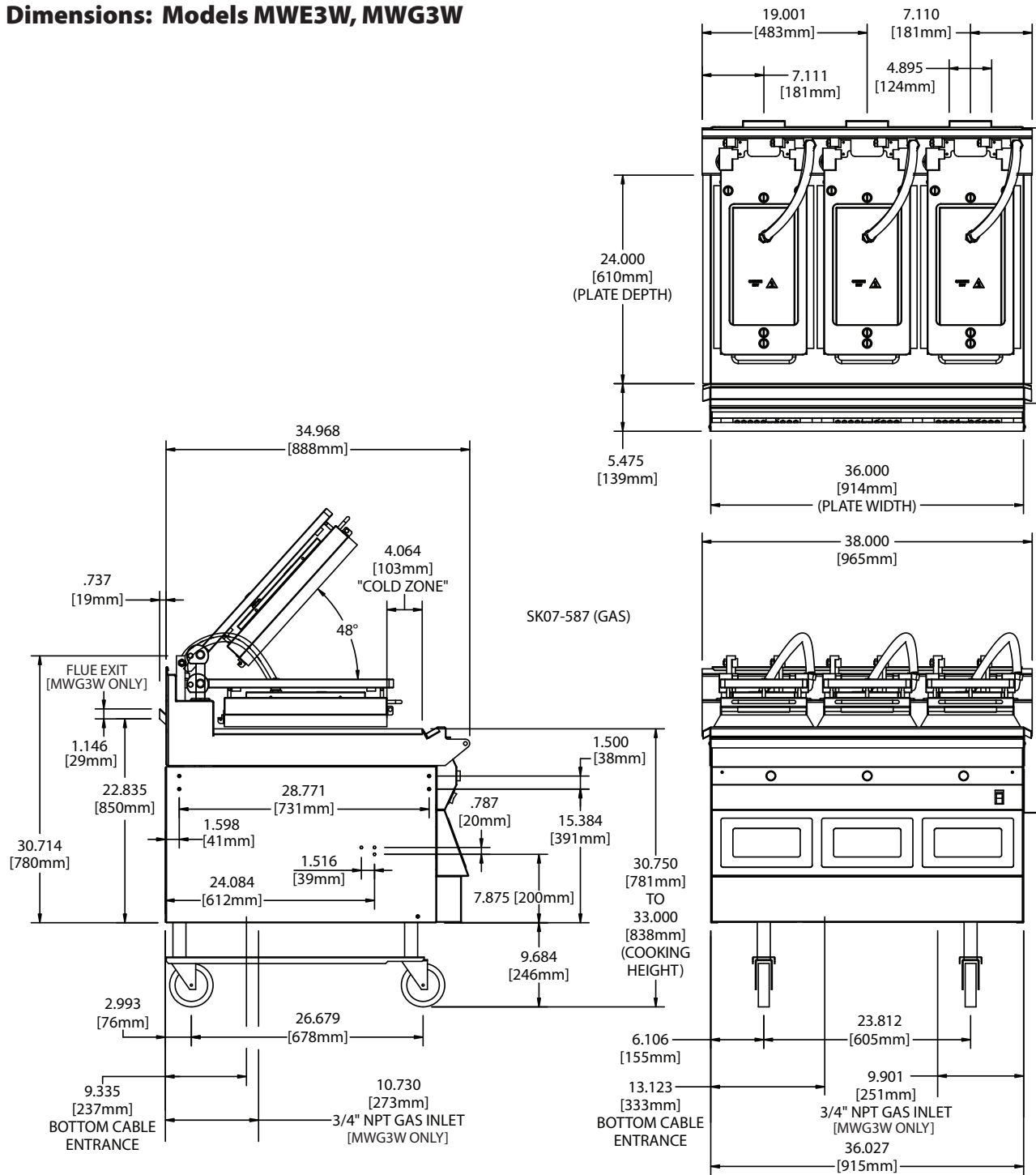

SPECIFICATIONS

Dimensions: Model MWE3S

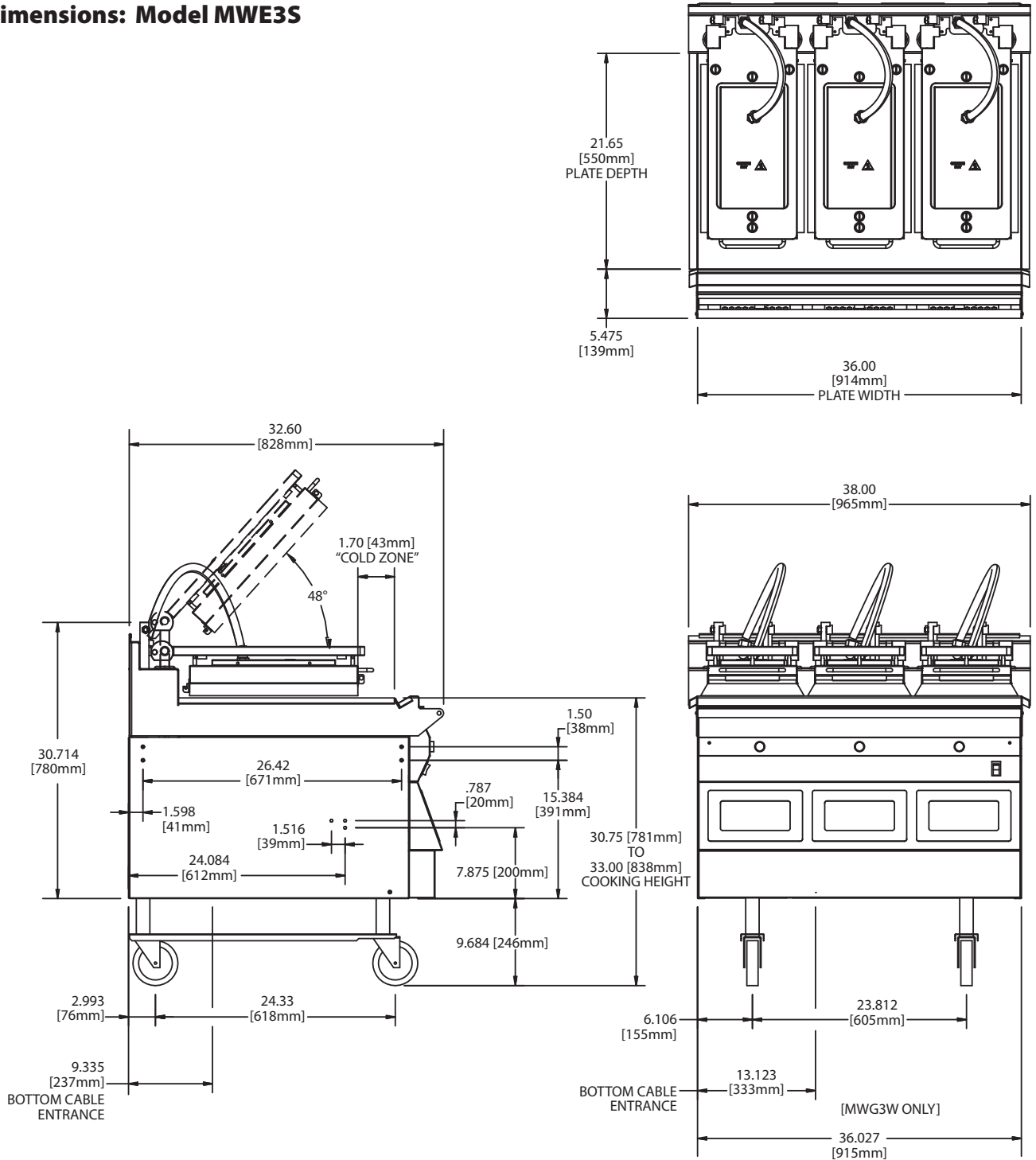

SPECIFICATIONS

Input Specifications, ELECTRIC FULL SIZE Grills, MWE3W, United States:

SUPPLY REQUIRED	TOTAL KW LOAD	NOMINAL AMPS PER LINE								
		208V			220V			240V		
		L1	L2	L3	L1	L2	L3	L1	L2	L3
INPUT 1	7.65	21.3	21.3	21.3	20.1	20.1	20.1	18.4	18.4	18.4
INPUT 2	15.30	42.6	42.6	42.6	40.2	40.2	40.2	36.8	36.8	36.8

Input Specifications, ELECTRIC FULL SIZE Grills, MWE3W, Western Canada:

SUPPLY REQUIRED	TOTAL KW LOAD	NOMINAL AMPS PER LINE					
		208V			240V		
		L1	L2	L3	L1	L2	L3
INPUT 1	22.95	63.9	63.9	63.9	55.2	55.2	55.2

Input Specifications, Electric Grills, CE Approved Models MWE3W-CE, MWE3S-CE:

SUPPLY	TOTAL kW LOAD	LOADING: (kW/PHASE)			NOMINAL AMPS PER LINE			MENNEKES PLUG & RECEPTACLE MAY BE REQUIRED
		230V / 400V			230V / 400V			
3N~ 400V 50Hz	22.7	L1/L2	L1/L3	L2/L3	L1	L2	L3	
		7.60	7.60	7.60	33.0	33.0	33.0	Type 748

Input Specifications, Electric Grills, Export, Non-CE Models MWE3W, MWE3S:

SUPPLY	TOTAL kW LOAD	LOADING: (kW/PHASE)			NOMINAL AMPS PER LINE			MENNEKES PLUG & RECEPTACLE MAY BE REQUIRED
		230V / 400V			230V / 400V			
		L1/L2	L1/L3	L2/L3	L1	L2	L3	
220V 50Hz	22.7	7.60	7.60	7.60	34.5	34.5	34.5	Type 748
240V 50Hz	22.7	7.60	7.60	7.60	31.6	31.6	31.6	

SPECIFICATIONS

Input Specifications, GAS Grills, North America:

SUPPLY REQUIRED	TOTAL kW LOAD	LOADING: (kW/ PHASE)			NOMINAL AMPS PER LINE								
		208V / 220V / 240V			208V / 60Hz			220V / 60Hz			240V / 60Hz		
		L1/L2	L1/L3	L2/L3	L1	L2	L3	L1	L2	L3	L1	L2	L3
INPUT 1	10.0	3.25	3.25	3.25	28.0	28.0	28.0	26.3	26.3	26.3	24.0	24.0	24.0

GAS INPUT						
GAS	MAX INPUT (NET) PER BURNER (BTU/H)	TOTAL INPUT RATING (BTU/H)	INJECTOR SIZE	AIR SHUTTER SETTING (MM)	SUPPLY PRESSURE (IN W.C.)	BURNER MANIFOLD PRESSURE (IN W.C.)
NATURAL GAS	32,000	96,000	#35	4.8	3.5	3.5
PROPANE	32,000	96,000	#43	4.8	3.5	3.5

Input Specifications, GAS Grills, CE Approved Model MWG3W-CE:

3N~ 400V 50Hz	TOTAL kW LOAD	LOADING: (kW/PHASE)			NOMINAL AMPS PER LINE			MENNEKES PLUG & RECEPTACLE MAY BE REQUIRED
		L1/L2	L1/L3	L2/L3	L1	L2	L3	
	10.0	3.25	3.25	3.25	14.1	14.1	14.1	Type 748

GAS INPUT							
GAS GROUP	MAX INPUT (NET) PER BURNER (kW)	TOTAL INPUT RATING (kW)	INJECTOR SIZE	AIR SHUTTER SETTING (mm)	SUPPLY PRESSURE (mbar)	BURNER PRESSURE (mbar)	VOLUMETRIC GAS RATE
G20 NG	8.9	26.7	2.79mm (#35)	4.8	20/25	8.7	0.940 m³/h
G25 NG			2.79mm (#35)	4.8	20	8.7	
G31 LPG	8.9	26.7	2.26mm (#43)	4.8	37/50	8.7	0.69 kg/h

NET HEATING VALUE BY GAS GROUP		
G20	G25	G31
34.02 MJ/m³; 0.555 SG	29.25 MJ/m³; 0.613 SG	88.0 MJ/m³ (46.34 MJ/kg); 1.55 SG

GAS CATEGORIES		
CATEGORY	DESTINATION COUNTRIES	SUPPLY PRESSURE (mbar)
I _{2H}	AT, CH, CZ, DK, ES, FI, GB, IE, IS, IT, NO, PT, SE	20.0
I _{2E}	DE, LU	20.0
I _{2L}	NL	25.0
I _{2ER}	FR	20.0 / 25.0
I _{3P}	NL	30.0
I _{3P}	BE, CH, CZ, ES, FR, GB, GR, IE, LU	37.0
I _{3P}	BE, CH, DE, CZ, ES, FR, NL	50.0

INSTALLATION & STARTUP

Installation Store Responsibilities:

- Ensure grill has been installed by a competent trained installation person.
- Ensure store readiness of utilities, product & personnel.
- Contacting your local Garland Factory Authorized Service Center for a startup date.
- Participate in the startup to ensure a successful startup and familiarity with the grill.
- Conduct training with your crew personnel to ensure maximum utilization of the grill.

Once the installation is complete as per the procedures below, a factory authorized service company **MUST** startup the grill according to Garland Commercial Industries startup standards.

A startup DOES NOT include:

1. Uncrating the unit
2. Placing the unit in its position under the exhaust hood.
3. Leveling the grill on the floor under the exhaust hood.
4. Attaching the supply cord(s) unless supplied by the factory.
5. Making adjustments to the ventilation system.
6. Sheet metal work required due to improper exhaust hood application.
7. Adjusting the grill to achieve beef integrity that deviates from the McDonalds standard.

A start-up DOES include:

1. Verification of supply voltage and, if applicable gas supply.
2. Leak test and gas pressure check on gas grills.
3. Electrical safety check.
4. Verify operation of grill by allowing unit to attain set temperature.

5. Verify operation of platens, if applicable, and timer functions.
6. Ensure time out alarm is functional and platens raise (if applicable)
7. Set proper gas and verify with beef integrity check that two consecutive runs yield the approved beef integrity results as per McDonalds standards.
8. Conduct brief training to store manager on the operation of the grill.

Items included with the purchase of your new grill from Manufacturer:

1. One (1) grill
2. One (1) gas hose (for gas grills only)
3. One (1) box containing:
 - a. Six (6) release material sheets
 - b. Three (3) release material clips
 - c. Three (3) release material rear rods.
4. One (1) box containing four (4) casters.

Items NOT INCLUDED from the manufacturer and should be purchased from the KES:

1. Any electrical cords needed for application.
2. Any flue box needed for application.
3. Any grease traps or grease rails needed for application.

THE FOLLOWING INSTALLATION PROCEDURE CAN BE PERFORMED BY A:

- FACTORY AUTHORIZED SERVICE CENTER
- AN APPROVED INSTALLATION PERSON APPROVED BY PURCHASER OF GRILL
- LICENSED INSTALLER CONTRACTED BY KES (KITCHEN EQUIPMENT SUPPLIER)

WARNING: PLEASE READ INSTALLATION INSTRUCTIONS CAREFULLY. FAILURE TO PERFORM THESE STEPS CAN RESULT IN EQUIPMENT FAILURE, DAMAGE AND / OR VOID OF WARRANTY.

INSTALLATION & STARTUP *(continued)*

1. Uncrate unit from crating material

CAUTION: Prior to installation, check the electrical supply to ensure input voltage and phase match the equipment voltage rating and phase.

NOTE: ENSURE THAT PLATENS ARE STRAPPED DOWN SECURELY THROUGH STEP 3 TO PREVENT PLATENS FROM RAISING. SEVERE DAMAGE MAY OCCUR.

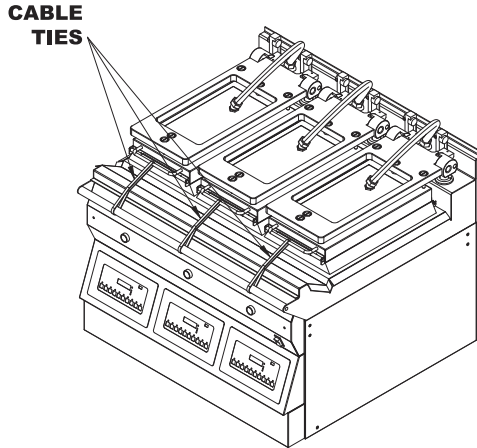

2. Tip unit over on its back. Install caster channels and casters as shown. **WARNING:** It is recommended that the rear casters are screwed in all the way before tipping.

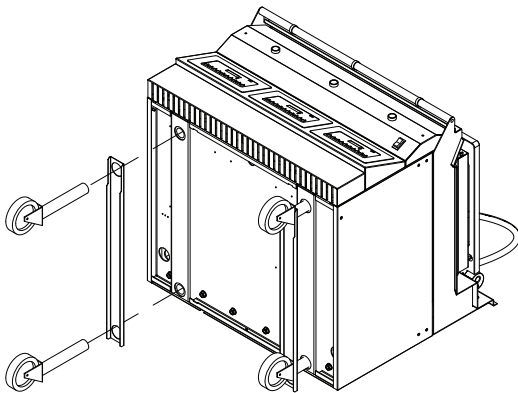

3. Carefully rotate grill back on its casters. Now you may cut and remove the platen securing straps.

4. Remove back body side and Install power cords per your country / area's specifications.

WARNING: Electrical appliances must be electrically grounded in accordance with local codes or in the absence of local codes, with national electric code ANSI/NFPA - latest version.

All electric connections must be made by a qualified, properly equipped technician.

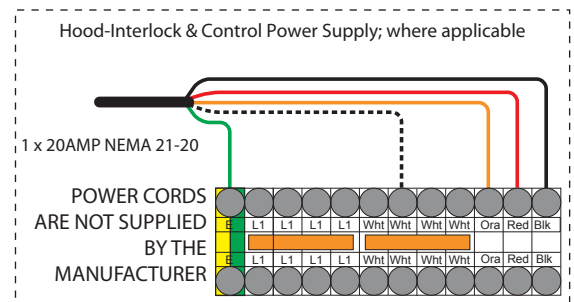
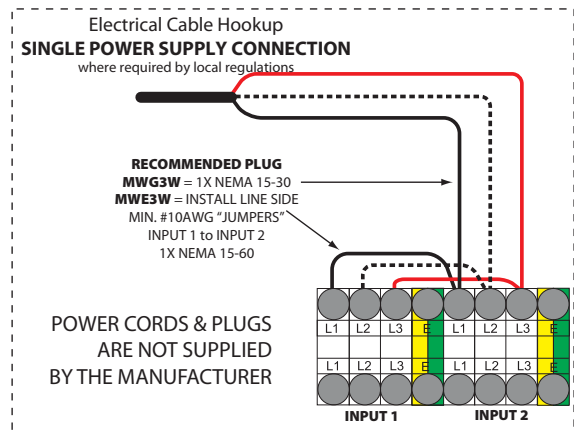
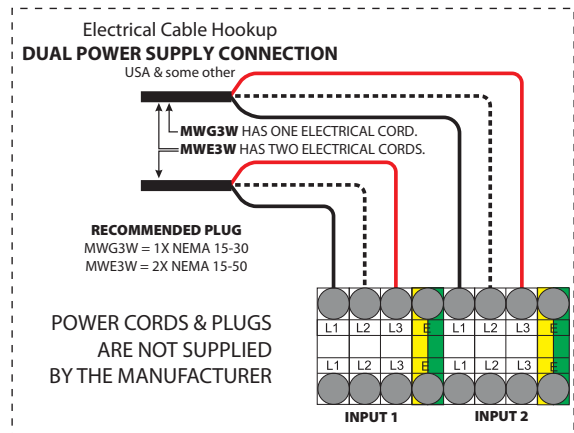

INSTALLATION & STARTUP *(continued)*

5. **GAS GRILL ONLY**, (for electric grills, skip to step 7):
Install the included quick-disconnect gas hose to the inlet fitting on the underside of the grill by threading a 3/4" NPT nipple into the elbow, then install the brass male quick-disconnect coupler included with the hose.

Connect the hose and ensure the sleeve snaps fully forward against the retaining ring.

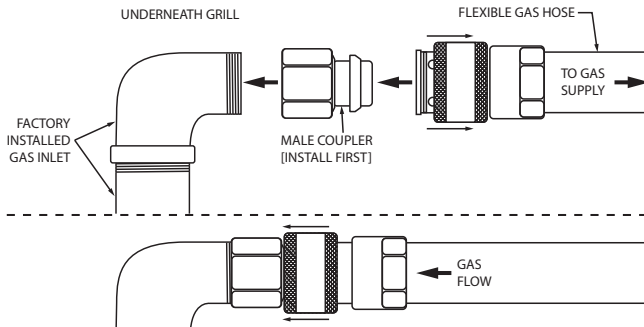

With the manual shut-off valve closed, install the other end of the hose to the gas supply.

6. Install Optional Front Gas connection (If available).

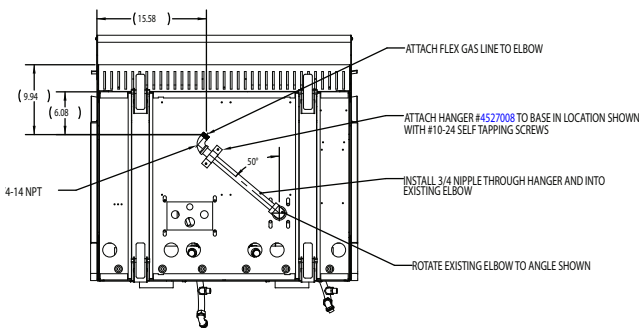

- Isolate grill from any power source by unplugging all electrical connections.
- Rotate existing elbow 50° as shown in the diagram to the left.
- Attach hanger PN [4527008](#) as shown with 10-24 self tapping screws.
- Install 3/4 nipple through hanger and into existing already rotated elbow.
- Install 3/4 elbow fitting to 3/4 nipple.
- Attach gas hose to extended gas line.

7. Install grease bucket rails as shown below:

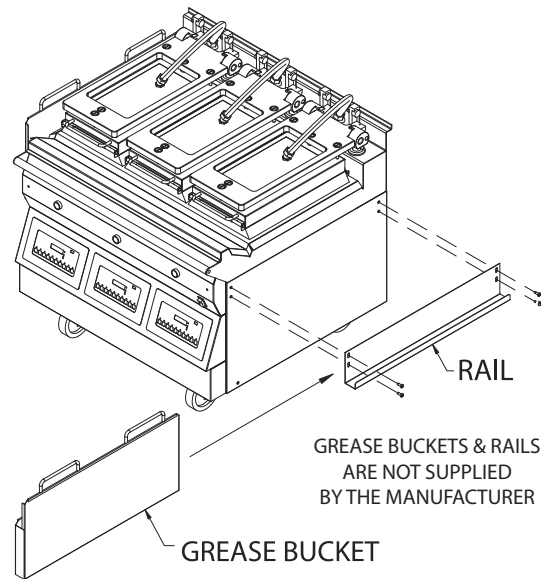

8. Install flue box to back of grill.

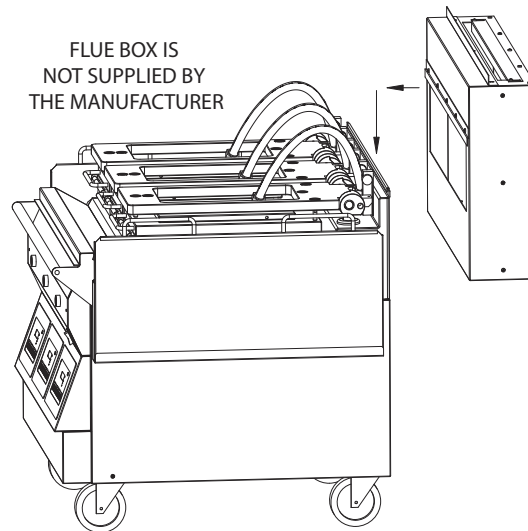

9. Roll grill under exhaust hood. Grill must be level front to back, side to side and diagonally. Adjust casters accordingly to obtain final level.

INSTALLATION & STARTUP *(continued)*

Exhaust hood Type & Platen Height

With the platens in the raised position, measure the height from the front edge of the platen to the grill surface. Determine which type of exhaust hood the store has and check for exhaust hood type/platen height compatibility according to the table below:

Exhaust hood TYPE	CORRECT PLATEN HEIGHT
Universal	18 ½" (470mm)
92 Series	17" (432mm)
GSC	18 ½" (470mm)

If the platen height is incompatible with the exhaust hood type, platen height must be adjusted by an authorized service agent.

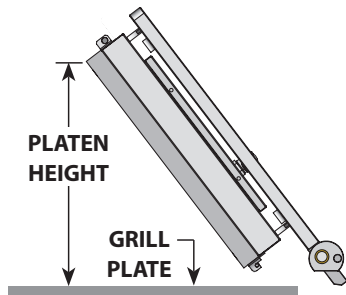

INSTALLATION & STARTUP *(continued)*

Startup Procedure

This Garland 3-platen grill comes with a factory startup at no additional charge. A startup is required to take place **BEFORE** the unit is put into operation. It is the end-user responsibility to schedule the startup with their local Factory Authorized Service Agent, or notify Garland Commercial Industries at 1-800-446-8367 should you need assistance scheduling.

A factory startup is a comprehensive grill check in which a factory certified technician will document all final settings programmed in the controller once various other performance checks are complete. The estimated time to complete a startup is approximately 2.5 – 3.5 hours. Please keep in mind this estimated time when scheduling the startup. After hours or overtime is not covered under warranty and will be billed at a charge which is the difference between the Garland Reimbursement rate and the Factory Authorized Service Centers overtime charges.

A factory startup is necessary to start the warranty period. The Authorized Service Center is required to complete the paperwork during the startup process, and send it to Garland Commercial Industries for reimbursement. At the time of receipt, Garland will start the warranty period which will conclude at the end of 2 years. You may contact your Kitchen Equipment Supplier or dial 1-866-735-1955 for more details regarding an optional 3rd year extended warranty plan.

All aspects of the Startup procedure must be documented using the Garland-issued form, part #4521780:

GARLAND CLAMSHELL GRILL START – UP FORM
ELECTRIC OR COMBINATION GAS / ELECTRIC
(FOR USE IN MODEL MWE3W/MWG3W & MWE2W/MWG2W Series grills ONLY)

McDonald's _____ Certification ID # _____ Store # _____ Start-up Date _____
Located on Certification Sticker MM / DD / YY

Address _____ City _____ Model # MWE3W | MWG3W | MWE2W | MWG2W
Circle One

State / Province _____ Zip Code _____ Serial # _____

United States Canada International (List Country) _____ Telephone # _____

Gas Type	Electric / 3-phase		Record Amps Per Line Each Contactor		
	Actual Input	Actual Input	Left	Center (# Applicable)	Right
Actual Gas Type _____	<input type="checkbox"/> 208 VAC	<input type="checkbox"/> 380 VAC	Line 1		
Matches Rating Plate? YES NO	<input type="checkbox"/> 220 VAC	<input type="checkbox"/> 400 VAC	Line 2		
	<input type="checkbox"/> 230 VAC	<input type="checkbox"/> 415 VAC	Line 3		
	<input type="checkbox"/> 240 VAC				

INSPECTION / OPERATIONAL CHECK
NOTE: CENTER PLATEN should not be checked if MWE2W / MWG2W

1. Ensure grill is installed in the proper type of gas exhaust hood with the proper air draw.	<input type="checkbox"/> OK
2. Ensure flu restrictors are fully opened or removed. <small>Flue Box Supplied by KES Flu Restrictors located inside exhaust hood</small>	<input type="checkbox"/> OK
3. Ensure bottom plate is leveled side to side / front to back / diagonally, in location, under hood. Adjust casters to attain level.	<input type="checkbox"/> OK
4. REMOVE GRILL FROM UNDER THE HOOD. Turn Power Switch ON, controller displays are active, Controller displays "OFF" . All platen raises automatically?	L <input type="checkbox"/> OK C <input type="checkbox"/> OK R <input type="checkbox"/> OK
5. Lower and raise Upper Platen and insure movement is smooth and continuous. Grease shafts accordingly with a FOOD GRADE LUBRICANT.	L <input type="checkbox"/> OK C <input type="checkbox"/> OK R <input type="checkbox"/> OK
6. If upper platen elevation requires lowered to allow for clearance of hood, lower upper limit switch. Refer to Operations & Installation manual for platen heights.	L <input type="checkbox"/> OK C <input type="checkbox"/> OK R <input type="checkbox"/> OK
7. Press the POWER ON button. Controller displays "PREHEAT - AM", platen lowers. Heat indicator lights are AMBER?	L <input type="checkbox"/> OK C <input type="checkbox"/> OK R <input type="checkbox"/> OK
8. Press the AM / PM key. This will allow the unit to heat to: Platen-425°F(217°C), Grill-350°F(177°C).	L <input type="checkbox"/> OK C <input type="checkbox"/> OK R <input type="checkbox"/> OK
9. Grill enters SOAK mode (15:00 timer), counts down and upper platen auto calibrates at temperatures: Platen-425°F(217°C), Grill-350°F(177°C)	L <input type="checkbox"/> OK C <input type="checkbox"/> OK R <input type="checkbox"/> OK
10. Close valve handle and verify the unit tries to ignite four (4) times. Unit locked out to Ignition Failure?	L <input type="checkbox"/> OK C <input type="checkbox"/> OK R <input type="checkbox"/> OK
11. GAS PRESSURE CHECKS (if applicable): Rated Incoming Pressure Natural Gas 6 – 14 Inches W.C. Actual Incoming _____ Propane / Butane Gas 11 – 14 Inches W.C. Actual Incoming _____ Rated Burner Pressure Natural Gas 3.5 Inches W.C. Actual Left _____ Center _____ Right _____ Propane / Butane Gas 3.5 Inches W.C. Actual Left _____ Center _____ Right _____	
12. Check micro amp reading to ensure operating micro amps ARE NO LESS THAN .8. Micro Amp reading should be between .9 – 1.2.	
13. Upon Completion of auto calibration, platen raised automatically, and display reads "READY" <i>If upon completion of auto calibration process, upper platen does not raise, indicate message on controller. Check platen level and adjust reed switches. Cycle power and retry.</i>	OK - <input type="checkbox"/> L / <input type="checkbox"/> C / <input type="checkbox"/> R Check Platen Level - <input type="checkbox"/> L / <input type="checkbox"/> C / <input type="checkbox"/> R Check Reed Switch - <input type="checkbox"/> L / <input type="checkbox"/> C / <input type="checkbox"/> R
14. Select menu item "10:1 – CLAM". Verify set temperature is reached and LED lights turn GREEN.	L <input type="checkbox"/> OK C <input type="checkbox"/> OK R <input type="checkbox"/> OK
15. Initiate cook cycle by pushing the GREEN PUSHBUTTON. Platen lowers, and timing cycle begins.	L <input type="checkbox"/> OK C <input type="checkbox"/> OK R <input type="checkbox"/> OK
16. Ensure the stores pyrometer is accurate and calibrated using the ice bath method.	<input type="checkbox"/> OK
17. Perform PROBE CALIBRATION.	L <input type="checkbox"/> OK C <input type="checkbox"/> OK R <input type="checkbox"/> OK
18. Perform Platen Zeroing procedure & Reed Switch Calibration in "LEVEL / REED SW" mode.	L <input type="checkbox"/> OK C <input type="checkbox"/> OK R <input type="checkbox"/> OK
19. Platen performed Auto Calibration upon completion of reed switch calibration?	L <input type="checkbox"/> OK C <input type="checkbox"/> OK R <input type="checkbox"/> OK
20. Assist or obtain assistance with store personnel for Beef Integrity Testing , testing product 10:1 and 4:1 until desired internal product temperatures are met.	L <input type="checkbox"/> OK C <input type="checkbox"/> OK R <input type="checkbox"/> OK
21. Record cook times, gap settings, and any gap calibrations used to obtain beef integrity.	L <input type="checkbox"/> OK C <input type="checkbox"/> OK R <input type="checkbox"/> OK
22. Record Calibration numbers below:	

Product Cook Times (MWE3W & MWG3W MWE2W & MWG2W)	Calibration numbers (from CALIBRATION MENU)			
	LEFT	CENTER <small>(# Applicable)</small>	RIGHT	
10:1				
4:1				
ANGUS				

Calibration numbers (from CALIBRATION MENU)									
MWE2W & MWG2W ONLY									
2 PLATEN PRC Grills ONLY	Front LT Cal	Back LT Cal	Front RT Cal	Back RT Cal	Front LT Detect	Back LT Detect	Front RT Detect	Back RT Detect	
LEFT									
CENTER									
RIGHT									

Problems / Special Circumstances / Damage: _____

Submitted by:	Accepted by:
Name: _____	Name: _____
Service Agency: _____	Are you satisfied with the start-up procedure that has been performed? Please indicate any comments
Sub Agent: (If Applicable) _____	_____
Are you a factory certified technician? YES / NO	_____
Date of Certification / /	_____

White Copy – Factory
Yellow Copy – Service Agency
Pick Copy – Customer

Rev 3 P/N 4521780 W(091609)

INSTALLATION & STARTUP *(continued)*

Setting the Proper Combustion levels



In order to maintain proper combustion levels, the measurement of uA is not required. Using the following procedure will ensure that the proper O₂, CO₂, & CO levels are reached. If you have any questions, please contact 1-800-446-8367.

1. Remove control panel and lower front panel. Set on floor, leaving all connections in place.
2. The regulator comes set at 3.5" W.C (0.864 KPA) from the factory. Verify pressure is consistent at 3.5".
3. Slightly loosen nut holding butterfly air shutter adjuster on the combustion air blower connected to the burner being adjusted just enough that it can be rotated but will stay in place when force is removed.

4. From a cold start, turn on the zone (burner) and allow it to run for 30 seconds to a minute. Or with a heated zone, place a load on the grill surface to keep the burner operating for a couple of minutes. Adjust the air shutter to reduce the air to the point that the flame on the burner begins to lift and dance off of the burner surface.

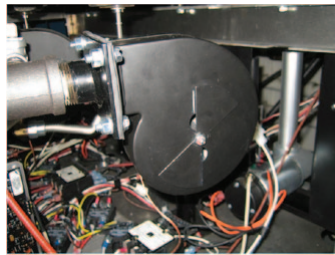

- a. Mark a line along the edge of the air shutter from the hole along the edge of the shutter marking the position of the shutter on the side of the blower face.
- b. If this condition already exists, mark the line at that position and move to the next step.

5. Rotate the air shutter open to the point that the flame loses its inner light blue cone and becomes less bright and the tip of the flame elongates and becomes about an inch (25.4 mm) long. Mark a line off the edge of the shutter at this position..



- a. Or if air shutter is fully open, mark the line at that point.

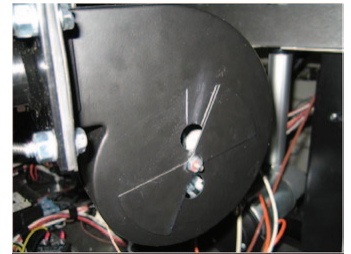

6. Turn off burner (zone) and measure the distance between the outside ends of the 2 line previously marked and place another mark in the center of the 2 marks.

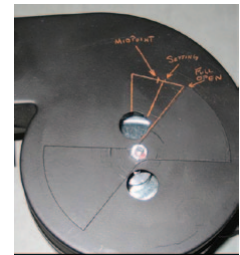

- a. Add another mark 1/16" (1.6 mm) more than the center mark.
- b. Rotate the butterfly shutter to this point, and retighten.

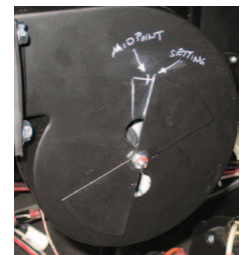
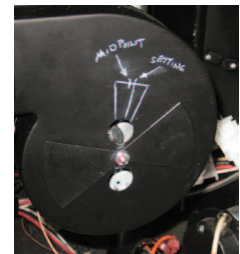

INSTALLATION OF WRAP AROUND RELEASE MATERIAL MOUNTING BRACKETS

CAUTION: UPPER PLATEN IS EXTREMELY HOT. WARNING: ISOLATE POWER SOURCE TO PREVENT ELECTRICAL SHOCK.

1. Ensure Electrical Power is unplugged before proceeding to next step.
2. Loosen 2 screws from each side of the platen lid.
3. Position side bracket assemblies over screws and insert into place.

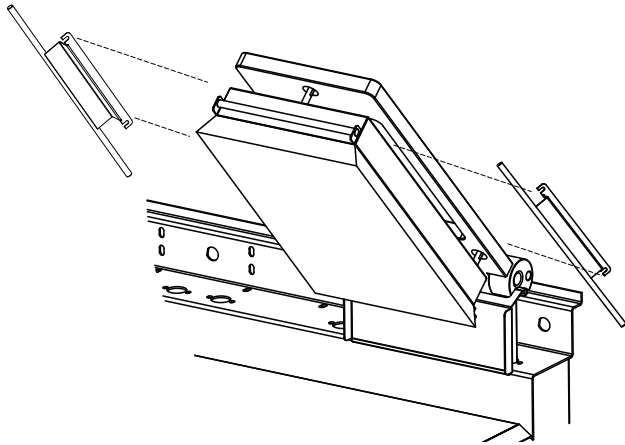

4. Retighten four (4) screws on the platen lid.

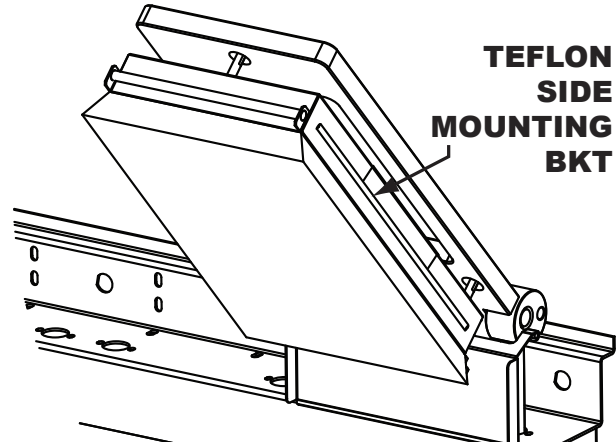

**TEFLON
SIDE
MOUNTING
BKT**

Part Number	Description	Qty Per Full Size (3P) Grill
4526334	Release Material sheet Bracket, Side (3 Platen Grill)	6 Grill, 2 Platen
4527294	Release Material sheet Clip w/ Flange	15 Grill, 5 Platen

INSTALLATION OF SPLASH SHIELD

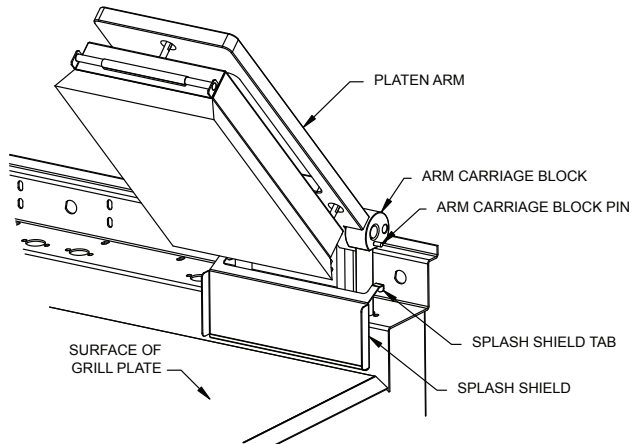

NOTE: SOME COMPONENTS OMITTED FOR CLARITY

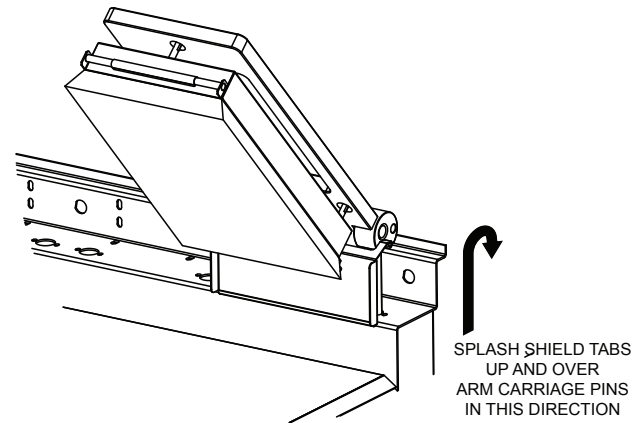

SPLASH SHIELD TABS
UP AND OVER
ARM CARRIAGE PINS
IN THIS DIRECTION

NOTE: SOME COMPONENTS OMITTED FOR CLARITY

INSTALLATION OF RELEASE MATERIAL

- Slide release material rod through hemmed end of the release material sheet.

- Hook release material rod on brackets located at the rear of the upper platen.

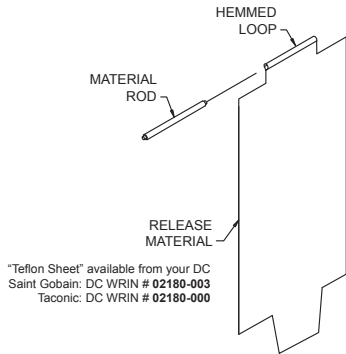

3. Holding the bottom of the release material sheet in place, gently pull the sheet toward the front of the platen.

NOTE: Make sure release material fits smoothly over upper platen.

4. Place one (1) locking clip over release material sheet in front and press into place over release material bar.

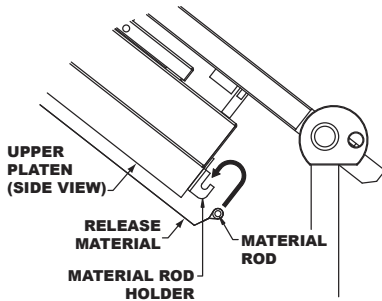

5. Gently pull the release material sheet flap over the left side of the platen and secure in place with two (2) locking clips.

6. Repeat step 5 with the right side.

NOTE: Failure to install the correct number of clips on the upper platen will cause the release material to be loose, and wear quickly. Ensure the correct placement of ALL clips to prevent premature wear and/or poor product quality.

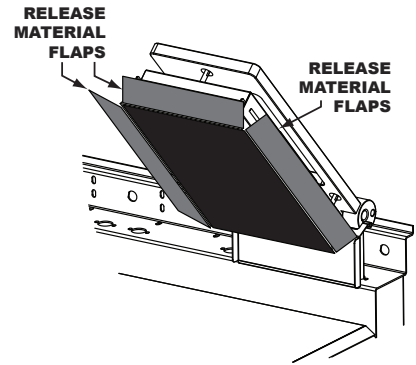

5. Check alignment and rightness of release material against upper platen.

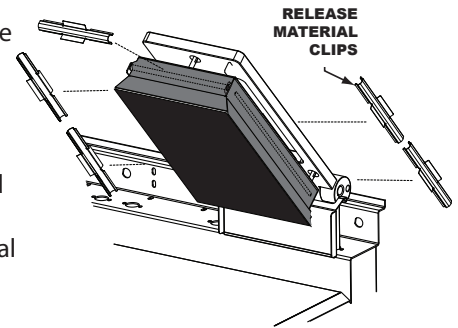

INSTALLATION OF VAPOR SHIELD

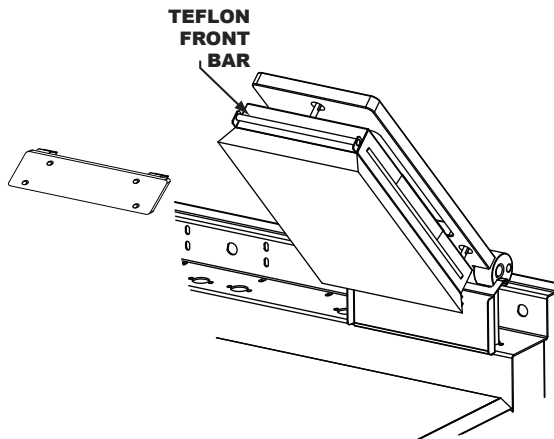

VAPOR SHIELD UP & OVER TEFLON FRONT BAR

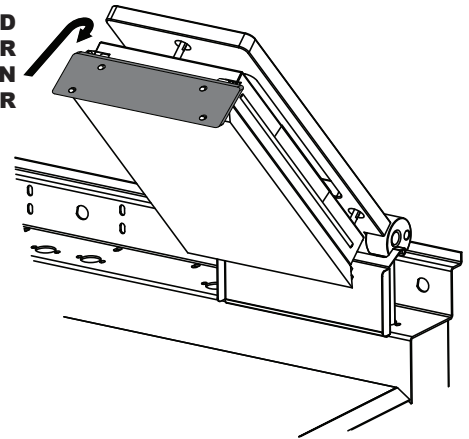

ACCESSORIES



Splash Shield
Item [4523492](#)

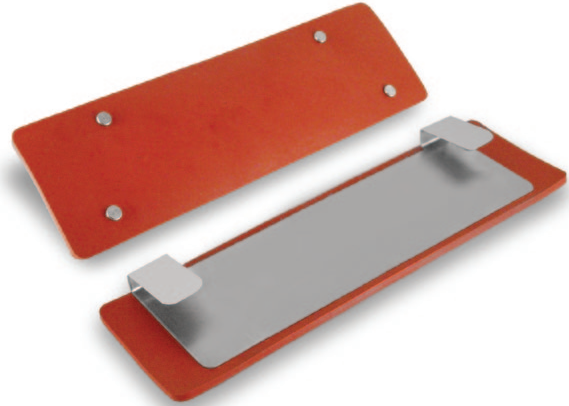

Vapor Shield Complete (2 shown)
Item [CK4525215](#)

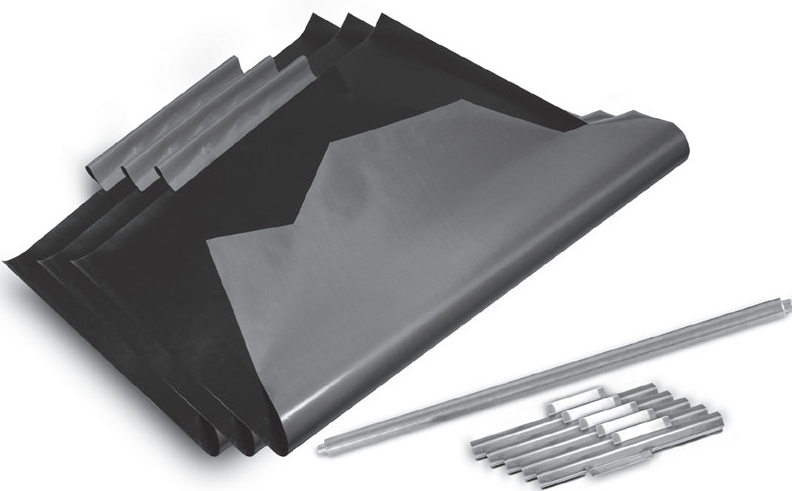

Teflon Wraparound kit (1 platen only)
CK4528080-1 - includes:
(3) Teflon Sheet (Wraparound) - [4527643](#)
(5) Clips - [4527294](#)
(1) Teflon Rear Bar - [4521355](#)

Teflon Wraparound kit (3 platens)
CK4528080-3 - includes:
(9) Teflon Sheet (Wraparound) - [4527643](#)
(15) Clips - [4527294](#)
(3) Teflon Rear Bar - [4521355](#)

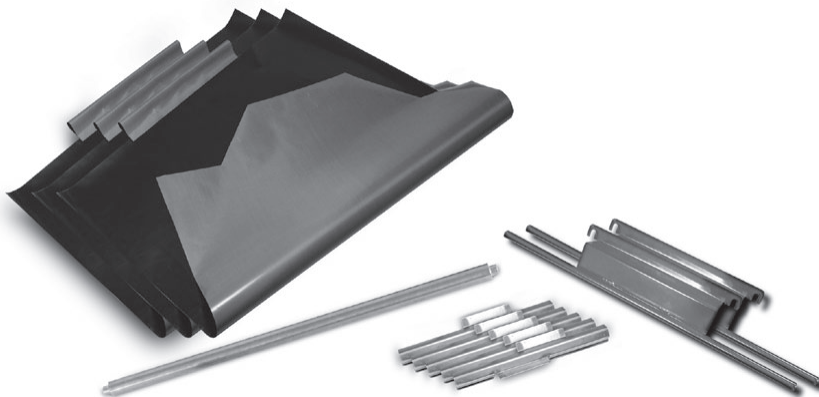

Teflon Wraparound kit (1 platen only) w/ Brackets
CK4528085-1 - includes:
(3) Teflon Sheet (Wraparound) - [4527643](#)
(5) Clips - [4527294](#)
(1) Teflon Rear Bar - [4521355](#)
(2) Wraparound side mount bkts - [4526334](#)

Teflon Wraparound kit (3 platens)
CK4528085-3 - includes:
(9) Teflon Sheet (Wraparound) - [4527643](#)
(15) Clips - [4527294](#)
(3) Teflon Rear Bar - [4521355](#)
(6) Wraparound side mount bkts - [4526334](#)

ACCESSORIES *(continued)*



Quick-Disconnect Gas Hose
Item [1591506](#)



NEMA# 51-50P

3Phase 4Wire 50 AMP Power Cord (Electric Grill ONLY)
(No Garland P/N) - *** Not supplied by Garland



NEMA# L15-30P

3Phase 4Wire 30 AMP Power Cord (Electric Grill ONLY)
(No Garland P/N) - *** Not supplied by Garland



NEMA# L21-20P

Interlock Cord - 5Wire
(No Garland P/N) - *** Not supplied by Garland

DESCRIPTION OF GRILL CONTROL

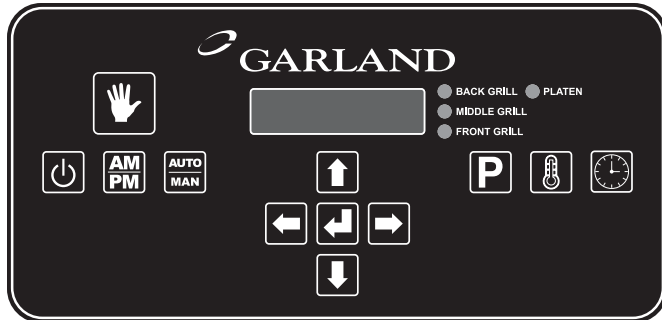

	Power Button – PRESSING and HOLDING the Power button for 2 seconds will either turn the controller on or off.
	AM/PM Button – In normal operating mode, toggles between the AM menu library and the PM menu library.
	AUTO/MAN Button – In normal operating mode, toggles between Automatic Product Recognition and Manual Cooking.
	Up Arrow Button – In any mode, increases the value of the flashing cursor character in the display
	Down Arrow Button – In any mode, decreases the value of the flashing cursor character in the display

	Right Arrow Button – In any mode, scrolls forward through a list
	Left Arrow Button – In any mode, scrolls backward through a list
	Enter Button – In the normal operating mode, this button is not active. In the Programming Mode, used to lock in the values shown on the display.
	Program Button – In the normal operating mode, pressing and holding the PROGRAM button for 3 seconds enters the Programming Mode.
	Temp Button – In the normal operating mode, displays the set temperature and the actual temperature.
	Speed Key – In the normal operating mode, used to change cook time. Also used to enter Probe Calibration Mode. & Perform Auto Forced Calibration
	Standby Button – In the normal operating mode, places the grill in Standby Mode.

POSSIBLE ERROR MESSAGES

GRILL PROBE ERROR – A grill probe circuit error for the Front, Middle, or Back zone has occurred.

PLATEN PROBE ERROR – An upper platen probe circuit error has occurred.

HEATER ERROR – Occurs when the controller does not detect a temperature rise in six (6) minutes.

HIGH TEMP – Occurs when the controller senses a temperature of 465° F (241° C).

CHECK REED SWITCH / USE FLAT COOK – One or more of the reed switches are out of adjustment. User will only be able to cook FLAT menu items.

ERROR COMMS - A communications error has occurred between the Motor Speed Control and the Main Control.

PLATEN NOT LEVEL – Occurs if the calibration difference between the front and rear is greater than maximum allowance. Product Recognition (Auto) and manual cooking is DISABLED. Flat Menu cooking is ONLY allowed.

CHECK PLATEN LEVEL – Occurs if the calibration difference between the front and rear is greater than the minimum allowance, but less than the maximum allowance. Product Recognition (Auto) is DISABLED. Perform **IF CHECK PLATEN LEVEL** is displayed, perform the following steps:

1. PRESS AND HOLD the and buttons for 3 seconds. The control will display “AUTO GAP FORCE”.
2. PRESS the button. “NO” will flash on the display. PRESS the button to change it to “YES.”
3. PRESS the button. The platen will immediately lower and reset its internal measurements. Upon completion, the platen will rise. If the error message does not return continue operating normally. If the error message persists, level the platen, as shown in section titled “Platen Leveling (Zeroing)”

OPERATING PROCEDURES

General Overview:

The PRC grill control will allow for 2 functions, both described in detail in the following sections

The **“Normal Operating Mode”**, also known as the Cook Mode is the mode used during normal cooking. In the normal operating mode, the operator can start a cook cycle, cancel a cook cycle, view actual temperatures, scroll to another menu item, and enter the Programming Mode.

The **“Programming Mode”** is the mode in which the operator can program the controller’s various settings. To enter the programming mode, PRESS and HOLD 

There are currently 3 methods of cooking that can be utilized with the MWE3 Garland clamshell:

Standard Cooking – This is the cook method that utilizes a single gap setting for each menu item. The timer will count down according to the selected menu item.



Multi Stage Cooking – This method of cooking utilizes 2 different gap settings during the cook cycle. The timer will count down according to the selected menu item.

Product Recognition – The product recognition method of cooking uses the magnetic switches mounted on the upper platen arm assembly to determine the product being cooked. Using the PR feature, the operator simply selects the  button on the controller. This will allow the controller to know what product group to select from. When a cook cycle is initiated, the platen will come down and recognize the product being cooked. The cook timer will count down according to the time set for the recognized item. For more information on product Recognition, see the next section; “Product Recognition.”

To turn the grill on:

The Main Power Switch – Controls power to the grill and must be turned ON to start operation. The controller displays will be active. Upon successful power up checks, the controllers will displays “OFF”.



AM Operation – Release Material sheets MUST be ON at this time and the grill surface should be free and clear of carbon.

Once the PRC displays “OFF” press . The PRC will go to PREHEAT mode and default to AM preheat temperatures. To preheat to PM temperatures, press and hold .

AM PREHEAT	PM PREHEAT
375°F (190°C) Upper Platen	425°F (218°C) Upper Platen
275°F (135°C) Grill	350°F (177°C) Grill

Upon reaching the AM or PM set temperature (whichever is selected), the grill will stabilize in temperature for fifteen (15) minutes. Once this time has elapsed, the grill will autocalibrate. Upon completion of autocalibration, the upper platens will raise to there normal position, and the PRC will display “READY”.

To Select a Menu item:

Scroll forward through the list of available menu items by pressing  repeatedly. Scroll backward through the list of available menu items by pressing  repeatedly.

Menu Item Library

The menu item library is loaded in the computer based upon the setting programmed in [CONFIGURE]->[GRILL REGION]. Each menu item consists of a function called [DISPLAY ACTIVE]. The settings in this function (AM, PM, AM/PM, No) determine what menu items are displayed

Menu Item #	Menu Item	Display Active – Default
1	10:1 - CLAM	PM
2	4:1 - CLAM	PM
3	STRIP BACON - CLAM	AM/PM
4	SAUSAGE CLAM FZN	AM
5	MCRIB - CLAM	NO
6	STEAK - CLAM	AM/PM
7	GRILLED CHICKEN - FLAT	PM
8	FOLDED EGGS FLAT	AM
9	ROUND EGGS - FLAT	AM
10	CHICKEN FLAT BRD - FLAT	NO
11	10:1 FLAT	NO
12	4:1 - FLAT	NO
13	MCRIB - FLAT	NO
14	SAUSAGE FLAT FZN	NO
15	HOTCAKES - FLAT	NO
16	OPT MENU 1 - CLAM	NO
17	OPT MENU 2 - CLAM	NO
18	OPT MENU 3 - CLAM	NO
19	OPT MENU 4 - CLAM	NO
20	OPT MENU 5 - CLAM	NO
21	OPT MENU 6 - CLAM	NO
22	OPT MENU 7 - CLAM	NO
23	OPT MENU 1 - FLAT	NO
24	OPT MENU 2 - FLAT	NO
25	OPT MENU 3 - FLAT	NO
26	OPT MENU 4 - FLAT	NO

OPERATING PROCEDURES *(continued)*

when the  button is pressed.

Indicator Lights

The LED lights on the main control indicate the temperature status of each zone.

Electric grills have (4) zones per section, TOP, (platen), BACK GRILL, MIDDLE GRILL, and FRONT GRILL.

Gas grills have (2) zones per section, TOP, (platen), and GRILL.

RED – The zone(s) is “TOO HOT” (more than 79°F/43°C over set temperature) OR a heat zone failure has occurred.

AMBER – The zone(s) is calling for heat.

GREEN – The zone(s) is at or above set temperature, but below 79°F/43°C over set temperature.

Standby Mode



To enter the standby mode:

1. Press the  button. The upper platen will lower, and the grill will maintain a set temperature of Upper platen - 425° F (218°C), Grill Surface - 350° F (177°C).

To Exit the standby Mode:

1. Press the  GREEN PUSHBUTTON. The upper platen will raise.





To display the current temperatures:

1. Press the  button and repeat for each zone to be displayed:
 - 1st key press – Front Set Point
 - 2nd key press – Front Actual
 - 3rd key press – Mid Set Point
 - 4th key press – Mid Actual
 - 5th key press – Back Set Point
 - 6th key press – Back Actual
 - 7th key press – Platen Set Point
 - 8th key press – Platen Actual
2. Pressing and holding the  button for five (5) seconds will display all of the current temperatures at once.

T###	F###	T###	GAS
M###	B###	GAS	B###

ELECTRIC DISPLAY GAS DISPLAY





Breakfast In Manual mode

1. Select AM mode. Press and hold the  button.
2. Select Manual mode. Press and hold the  button.
3. Select a product from the AM product library using the  or  arrow buttons.







4. Following McDonalds procedures for the item selected, load product on the grill.
5. Press the  GREEN pushbutton to initiate a cook cycle.
6. Alarm will sound when the cook cycle is complete.
7. Remove product and clean grill to prepare for the next cook cycle.

Lunch In Manual mode



Note: Switching from breakfast to lunch menu items will take approximately 10 minutes to heat to the appropriate temperatures.

1. Select PM mode. Press and hold the  button.
2. Select Manual mode. Press and hold the  button.
3. Select a product from the PM product library using the  or  arrow buttons.
4. Following the below lay pattern, load product on the grill.
5. Press the  GREEN pushbutton to initiate a cook cycle.
6. Alarm will sound when the cook cycle is complete
7. Remove product and clean grill to prepare for next cook cycle.

To Change The Cook Time for a Menu Item

1. Select AM or PM mode. Press and hold the  button.
2. Select Manual mode. Press and hold the  button.
3. Select a product using the  or  arrow buttons.
4. PRESS the  button to display the cook time.
5. Use the  and  buttons to change the cook time.
6. The control will automatically default back to the normal operating mode after 3 seconds.

Breakfast In Auto mode

1. Select AM mode. Press and hold the  button.
2. Select Auto mode. Press and hold the  button. The control will display “AM / AUTOMATIC”
3. Following McDonalds procedures for the item selected, load product on the grill.

OPERATING PROCEDURES (continued)

- | | |
|---|--|
| <ol style="list-style-type: none"> 4. Press the GREEN pushbutton to initiate a cook cycle. The platen will lower, and recognize the product that has been loaded on the grill. 5. Alarm will sound when the cook cycle is complete. 6. Remove product and clean grill to prepare for the next cook cycle. | <ol style="list-style-type: none"> 4. Press the GREEN pushbutton to initiate a cook cycle. The platen will lower, and recognize the product that has been loaded on the grill. 5. Alarm will sound when the cook cycle is complete 6. Remove product and clean grill to prepare for next cook cycle. |
|---|--|

Lunch In Auto mode

Note: Switching from breakfast to lunch menu items will take approximately 10 minutes to heat to the appropriate temperatures.

1. Select PM mode. Press and hold the button.
2. Select Auto mode. Press and hold the button. The control will display "PM / AUTOMATIC."
3. Following the lay patterns shown on the following page, load product on the grill.

Transition Cooking

Approximately 30 minutes before changing to the lunch menu, perform the following:

1. PRESS the button (to display the upper platen temperature).
2. Press the button.
3. The upper platen indicator will turn on. The upper platen will heat to 425 degrees F (217 degrees C) the platen will maintain this set temperature unless another menu item is selected..

PRODUCT RECOGNITION

This Garland Clamshell grill is equipped with Product Recognition Controls (PRC). This new technology allows the user to simply start a cook cycle WITHOUT having to select a specific menu item. The PRC will recognize the product thickness by utilizing switches inside the upper platen and the magnets mounted on the platen arms. Once the PRC calculates the thickness of the product that's been loaded, it will look up product from the product range library (below), and automatically select that product.

MENU ITEM	MIN GAP	MAX GAP
Breakfast Library Recommended Ranges		
Strip Bacon	.010	.130
Sausage Clam	.210	.405
Steak Clam	.430	.480

MENU ITEM	MIN GAP	MAX GAP
Lunch Library Recommended Ranges		
10:1 Clam	.160	.345
4:1 Clam	.365	.560
Strip Bacon	.001	.130

While cooking in Automatic Mode, the platen will lower and rest on the top of the product. The platen arms will continue to move in a downward motion performing various calculations to measure the thickness of the product that has been placed. In the event "**Product Not Recognized**" or the wrong product is recognized, perform an Forced Auto Calibration. Performing an Auto Force Calibration will reset the platen to the grill surface.

TO PERFORM FORCED AUTO CALIBRATION

1. PRESS and HOLD the and buttons together. The control will display "AUTO GAP FORCE - NO".
2. PRESS the button. The "NO" will begin to flash.
3. PRESS the button. The flashing "NO" will change to flashing "YES".
4. PRESS the button. **The upper platen will immediately begin to lower and perform an auto calibration routine.**

COMMON PRODUCT RECOGNITION ISSUES

Product Recognition Errors can appear in 2 ways:

1. After initiating cook cycle, the controller displays "PRODUCT NOT RECOGNIZED - NO RECIPE FOUND".
2. The controller displays the incorrect product for the product that was layed on the grill.

In both cases, the most common reasons for these 2 issues are as follows:

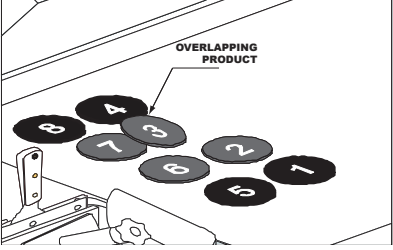
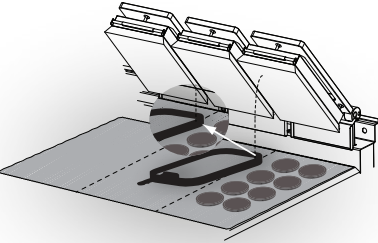
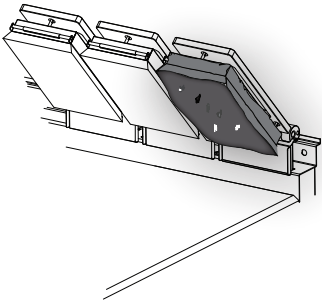
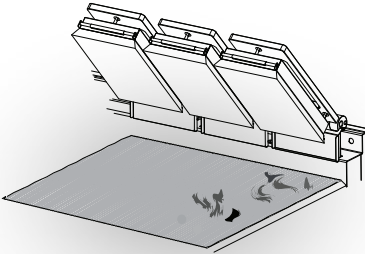
	<p>Overlapping Product - Ensure that you do not have any patties overlapping when you lay product. This will fool the controller into thinking that there is much thicker product on the grill than there is</p>			<p>Platen makes contact with Chicken Ring - Always make sure that the chicken ring is clear of the adjacent platen prior to initiating a cook cycle.</p>
	<p>Wrinkled or Worn Teflon Sheet - Ensure that the teflon sheet is installed and/or wrapped correctly to platen. A loose, worn, or teflon sheet with tears and/or scratches can effect product recognition.</p>			<p>Auto calibration done with carbon build up or product residue on grill surface - Ensure that the grill surface is free of any carbon build up. Debris on the grill surface during auto calibration will cause the control to mark the location of the grill surface incorrectly.</p>

In any of the cases as outlined above or in any other event, perform an Forced Auto Calibration to reset the upper platen distance to the grill surface. Prior to performing a Forced Auto Calibration, be sure to:

1. Make sure the upper platen is free and clear of any carbon build up or debris.
2. Ensure that the grill surface is scraped and cleaned.
3. Teflon sheet should not be worn and be fit to the upper platen tightly.

Perform a Forced Auto Calibration routine as indicated in section "PRODUCT RECOGNITION", "TO PERFORM FORCED AUTO CALIBRATION".

PATTY PLACEMENT

This procedure for placement and removal of meat products on the clamshell grill should be followed as indicated below and as follows:

1. Each gray rectangle depicted below represents one cooking; the area beneath one upper platen.
2. Patties are generally placed two at a time from front to back of grill and right to left.
3. The **removal order** of the patties is shown in the diagrams **by the number shown** in the center of each patty.

NOTE: Patty placement procedures for International Markets may differ. Follow the recommendations of your local McDonald's authorities.

Maximum patty load per lane:

- 8 regular (10:1) patties
- 4 angus (3:1) patties (region and country applicable)
- 6 quarter-pound (4:1) patties
- 8 sausage patties
- 6 circular bacon

NOTE: Lay patties 2 at a time, from front to back:

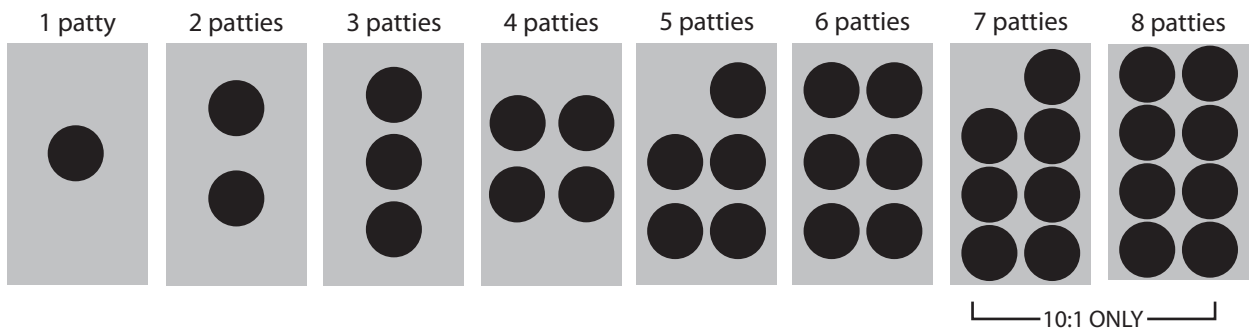

NOTE: Remove the patties in the number ordered shown below:

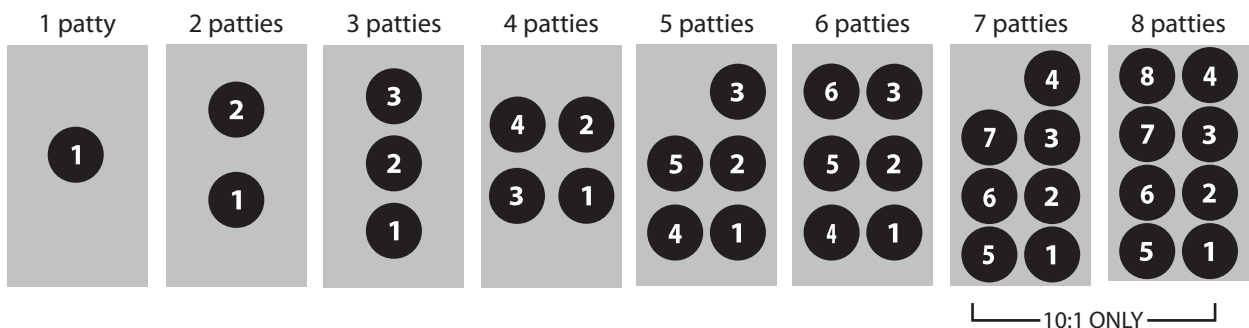

BEEF INTEGRITY

As shown in the previous page, lay product on the grill in the manner reflected. Product internal temperatures are taken on the corner patties.

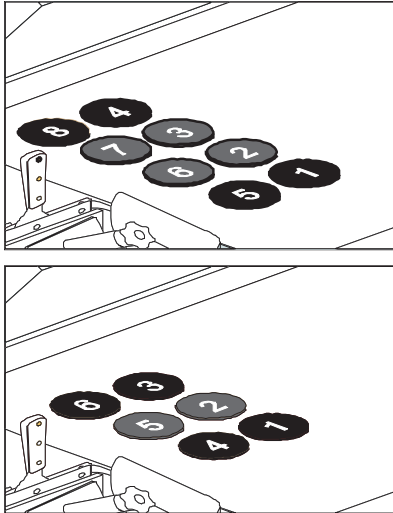

KEY NOTES:

- Full runs are always required when performing food safety
- Target removal times are 22 seconds for 10:1's & 15 seconds for 4:1's.
- Seasoning the patties must be done prior to removing the product from the grill..

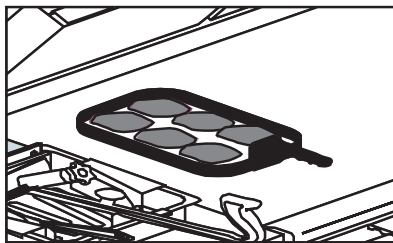

Cooking grilled chicken utilizes various functions and settings within the controller to ensure proper temperature and integrity.

The use of a "Too Cool Flag" is programmed under Menu Item programming. The Too Cool Flag should be set to "ON" in Grilled Chicken & Mushrooms ONLY. In all remaining menu items, the "TOO COOL FLAG" should be turned off.

The "Too Cool Flag" is a function in the control that allows the grill operator to continue to cook approximately 1 additional run of product should the grill be in a "TOO COOL" state prior to the start of a cook cycle, or at the end of a cook cycle.

10:1 Patties - Remove in 2 stacks of 4; Probe in center of corner patties (1, 4, 5, 8).

	Step 1: Using a store calibrated pyrometer, probe the #1 patty (front right corner) in the center of the patty.
	Step 2: Using a store calibrated pyrometer, probe the #4 patty (rear right corner) in the center of the patty.
	Step 3: Using a store calibrated pyrometer, probe the #3 patty (front left corner) in the center of the patty.
	Step 4: Using a store calibrated pyrometer, probe the #4 patty (left rear corner) in the center of the patty.

4:1 Patties - Remove in 3 stacks of 2; Probe in center of corner patties (1, 2, 5, 6)











	Step 1: Using a store calibrated pyrometer, probe the #1 patty (front right corner) in the center of the patty.
	Step 2: Using a store calibrated pyrometer, probe the #1 patty (rear right corner) in the center of the patty.
	Step 3: Using a store calibrated pyrometer, probe the #3 patty (front left corner) in the center of the patty.
	Step 4: Using a store calibrated pyrometer, probe the #4 patty (left rear corner) in the center of the patty.

CONTROL PROGRAMMING

Programming Modes; System Setup







To Change the Temperature Display Units (Fahrenheit / Celcius)





The temperature display units (F or C) will change the way a temperature is displayed on the controller (F – Fahrenheit, C – Celcius)

1. With the controller display ON and either displaying the current menu item or displaying "OFF", PRESS and HOLD the  button for approximately 3 seconds. Controller will display previously selected menu item and its corresponding item number OR "Standby / Menu Item".
2. PRESS the  AND  arrow buttons TOGETHER. "CONFIGURE" will appear in the display.
3. PRESS the  arrow button. "Setup" will appear in the display
4. PRESS the  button. "Temperature Unit" will appear in the display.
5. PRESS the  button. The currently set temperature unit will flash.
6. PRESS the  OR  arrow buttons to change the flashing temperature unit.
7. PRESS the  button to save the new setting.
8. PRESS THE  2X to exit the program mode.

To Change the Time Display Units











Changing the Time Display Units will change the way timing cycles are displayed on the controller.

1. With the controller display ON and either displaying the current menu item or displaying "OFF", PRESS and HOLD the  button for approximately 3 seconds. Controller will display previously selected menu item and its corresponding item number OR "Standby / Menu Item".
2. PRESS the  AND  arrow buttons TOGETHER. "CONFIGURE" will appear in the display.
3. PRESS the  arrow button. "Setup" will appear in the display.
4. PRESS the  button. "Temperature Unit" will appear in the display.
5. PRESS the  1X. "Time Unit" will appear in the display.

6. PRESS the  button. The current time unit will flash.
7. PRESS the  OR  arrow buttons to change the flashing time unit.
For a complete listing of setup functions and their options, see section titled "FUNCTION OPTIONS; SYSTEM MENUS".
8. PRESS the  button to save the new setting
9. PRESS THE  2X to exit the program mode.

To change the Key Chirp (Yes / No)

Changing the Key Chirp On or Off will either turn on or off the sound of the controller when a button is pressed.











1. With the controller display ON and either displaying the current menu item or displaying "OFF", PRESS and HOLD the  button for approximately 3 seconds. Controller will display previously selected menu item and its corresponding item number OR "Standby / Menu Item".
2. PRESS the  AND  arrow buttons TOGETHER. "CONFIGURE" will appear in the display.
3. PRESS the  arrow button. "Setup" will appear in the display
4. PRESS the  button. "Temperature Unit" will appear in the display.
5. PRESS the  repeatedly until "Key Chirp" appears in the display.
6. PRESS the  button. The currently set Key Chirp will flash.
7. PRESS the  OR  arrow buttons to change the flashing "YES" or "NO"
8. PRESS the  button to save the new setting.
9. PRESS THE  2X to exit the program mode.

To change the Audible

Changing the Audible Sound will change the way the controller sounds when a timing cycle has completed its countdown.











1. With the controller display ON and either displaying the current menu item or displaying "OFF", PRESS and HOLD the  button for approximately 3 seconds. Controller will display previously selected menu item and its corresponding item number OR "Standby / Menu Item".

CONTROL PROGRAMMING (continued)











2. PRESS the  AND  arrow buttons TOGETHER. "CONFIGURE" will appear in the display.
3. PRESS the  arrow button. "Setup" will appear in the display
4. PRESS the  button. "Temperature Unit" will appear in the display.
5. PRESS the  repeatedly until "Audible" appears in the display.
6. PRESS the  button. The currently set Audible will flash.
7. PRESS the  OR  arrow buttons to change the flashing audible options.
For a complete listing of setup functions and their options, see section titled "FUNCTION OPTIONS; SYSTEM MENUS".
8. PRESS the  button to save the current setting.
9. PRESS THE  2X to exit the program mode.

Programming Modes; Menu Items

To change the name of an existing menu item











1. Using the  or  button, select the menu item that requires a name change.
 2. PRESS and HOLD the  button for approximately 3 seconds. Controller will display previously selected menu item and its corresponding item number.
 3. PRESS and HOLD the  button.
 4. To spell out the product name:
 - a. Use the  or  arrow buttons to scroll through the character library.
- Character Library:
space ! " # \$ % & ' () * + , - . / 0 1 2 3 4 5 6 7 8 9 ; : < = > ? @ A B C D E F G H
I J K L M N O P Q R S T U V W X Y Z [\] ^ _ ` a b c d e f g h i j k l m n o p q r
s t u v w x y z
- b. PRESS  or  to scroll right or left.
 - c. PRESS the  button to save the new menu item name.
 5. PRESS the  2X to exit and return to normal operating mode.

To activate / deactivate a menu item in the Normal Operating mode library, or change its day-part (Defaults are listed in section "OPERATING PROCEDURES")

1. PRESS and HOLD the  button for approximately 3 seconds. Controller will display previously selected menu item and its corresponding item number.
2. Using the  or  arrow buttons, select the menu item that requires activation / deactivation.
3. PRESS the  button. The controller will display "Product". The menu item will flash.
4. PRESS the  or  arrow buttons until "Display Active" is displayed on the controller.
5. PRESS the  button. The current setting will flash.
6. PRESS the  or  button to select a different setting.
7. PRESS the  button to save the new setting.
8. PRESS the  2X to exit and return to normal operating mode.

To change the grill surface set point temperature











NOTE: Grill temperature set points are preset in the controller to the currently required standard. You should not change this set point to any temperature other than what is shown in section "OPERATING PROCEDURES"

1. Using the  or  arrow buttons, select the menu item that requires a temperature change.
2. PRESS and HOLD the  button for approximately 3 seconds. Controller will display previously selected menu item and its corresponding item number.
3. PRESS the  button. The controller will display "Product".
4. PRESS the  or  arrow buttons until "Grill SetPt" is displayed on the controller.
5. PRESS the  button. The current grill set temperature will begin to flash.
6. Using the  or  button, change the temperature set point to the new desired temperature.
7. PRESS the  button to save the new temperature set point.
8. PRESS the  2X to exit and return to normal operating mode.







CONTROL PROGRAMMING *(continued)*

To change the grill upper platen set point temperature









NOTE: Grill temperature set points are preset in the controller to the currently required standard. You should not change this set point to any temperature other than what is shown in section "OPERATING PROCEDURES".

1. Using the  or  button, select the menu item that requires a temperature change.
2. PRESS and HOLD the  button for approximately 3 seconds. Controller will display previously selected menu item and its corresponding item number.
3. PRESS the  button. The controller will display "Product".
4. PRESS the  or  button until "Platen SetPt" is displayed on the controller.
5. PRESS the  button. The "PLATEN SET POINT" will begin to flash.
6. Using the  or  button, change the temperature set point to the new desired temperature.
7. PRESS the  button to save the new temperature.
8. PRESS the  2X to return to normal operating mode.











To Change the MUST REMOVE IN time

1. Using the  or  button, select the menu item that requires a cook time change.
2. PRESS and HOLD the  button for approximately 3 seconds. Controller will display previously selected menu item and its corresponding item number.
3. PRESS the  button. The controller will display "Product".
4. PRESS the  or  button until "Must Remove In" is displayed on the controller.
5. PRESS the  button. The seconds will begin to flash.
6. Using the  or  arrow buttons to change the Must Remove In time to the new desired time.
7. PRESS the  button to save the new time.
8. PRESS the  2X to return to normal operating mode.

To Change the Toast Buns time

1. Using the  or  button, select the menu item that requires a cook time change.
2. PRESS and HOLD the  button for approximately 3 seconds. Controller will display previously selected menu item and its corresponding item number.
3. PRESS the  button. The controller will display "Product".
4. PRESS the  or  button until "Toast Buns Time" is displayed on the controller.
5. PRESS the  button. The seconds will begin to flash.
6. Using the  or  button, change the Toast Buns Time to the new desired time.
7. PRESS the  button to save the new time.
8. PRESS the  2X to exit and return to normal operating mode.





























To Change the Toast Buns Alarm (Auto / Manual)

1. Using the  or  arrow buttons, select the menu item that requires a cook time change.
2. PRESS and HOLD the  button for approximately 3 seconds. Controller will display previously selected menu item and its corresponding item number.
3. PRESS the  button. The controller will display "Product".
4. PRESS the  or  button until "Toast Buns Alarm" is displayed on the controller.
5. PRESS the  button. The "AUTO" or "MANUAL" will begin to flash.
6. Using the  or  arrow buttons to change the "MANUAL" to "AUTO" or "AUTO" to "MANUAL".
7. PRESS the  button to save the new setting.
8. PRESS the  2X to exit and return to normal operating mode.









CONTROL PROGRAMMING *(continued)*

To Add NEW Menu Items







The following programming instructions serves as a GUIDE for programming the basic settings for CLAM menu items.

1. PRESS and HOLD the  button for approximately 3 seconds. Controller will display previously selected menu item and its corresponding item number.
2. PRESS the  or  button until "Opt menu # - CLAM" is displayed on the controller.
3. PRESS the  button. The controller will display "PRODUCT"
4. PRESS and HOLD the  button. The currently select menu item name will begin to flash.
5. To spell out the product name:
 - a. Use the  or  arrow buttons to scroll through the character library.
 - b. PRESS  or  to scroll right or left.
 - c. PRESS the  button to save the new menu item name.
6. PRESS the  button. "Display Active" will be displayed.
7. PRESS the  button. "NO" will begin to flash.
8. PRESS the  button. "NO" will change to "YES".
9. PRESS the  button to save the new setting.
10. PRESS the  button. "GRILL SETPT" will be displayed.
11. PRESS the  button. The temperature will begin to flash.
12. Using the  or  button, change the temperature set point to the new desired temperature.
13. PRESS the  button to save the new temperature set point.
14. PRESS the  button. "PLATSETPT" will be displayed.
15. PRESS the  button. The temperature will begin to flash.
16. Using the  or  button, change the temperature set point to the new desired temperature.
17. PRESS the  button to save the new temperature set point.
18. PRESS the  button until "GAP MULTI/PR START" appears in the display.
19. PRESS the  button. The gap setting will begin to flash.
20. Using the  and DOWN button, change the gap setting to the desired setting.
21. PRESS the  button to save the new gap setting.
22. PRESS the  button 2X to exit and return to the normal operating mode.

To Restore Factory Defaults for All Product Menu Items

1. With the controller display ON and either displaying the current menu item or displaying "OFF," PRESS and HOLD the  button for approximately 3 seconds. Controller will display previously selected menu item and its corresponding item number OR "Standby / Menu Item."
2. PRESS the  AND  arrow buttons TOGETHER. "CONFIGURE" will appear in the display.
3. PRESS the  arrow button. "Setup" will appear in the display
4. PRESS the  button. "Temperature Unit" will appear in the display.
5. PRESS the  button 6x. The controller will display "Reload Defaults – NO."
6. PRESS the  button. "NO" will begin to flash.
7. PRESS the  button. "NO" will change to "YES".
8. PRESS the  button. The system will Reload the MENU items to factory default settings.
9. Wait 15-20 seconds. The control then automatically returns to OFF mode.

To Restore Factory Defaults for All Functions

1. Ensure the main power is turned off by turning the main power switch to the OFF mode.
2. PRESS the  AND  arrow buttons TOGETHER, while cycling main power ON with the main power switch. The control will display "PASSWORD"
3. Within 3-5 seconds, press the following keys in this sequence:     
4. Upon successful completion, the controller will display FULL DEFAULTS
5. Wait 15-20 seconds. The control then automatically returns to OFF mode.

PROGRAM LOGIC TREE; PRODUCT MENUS (software version 222)

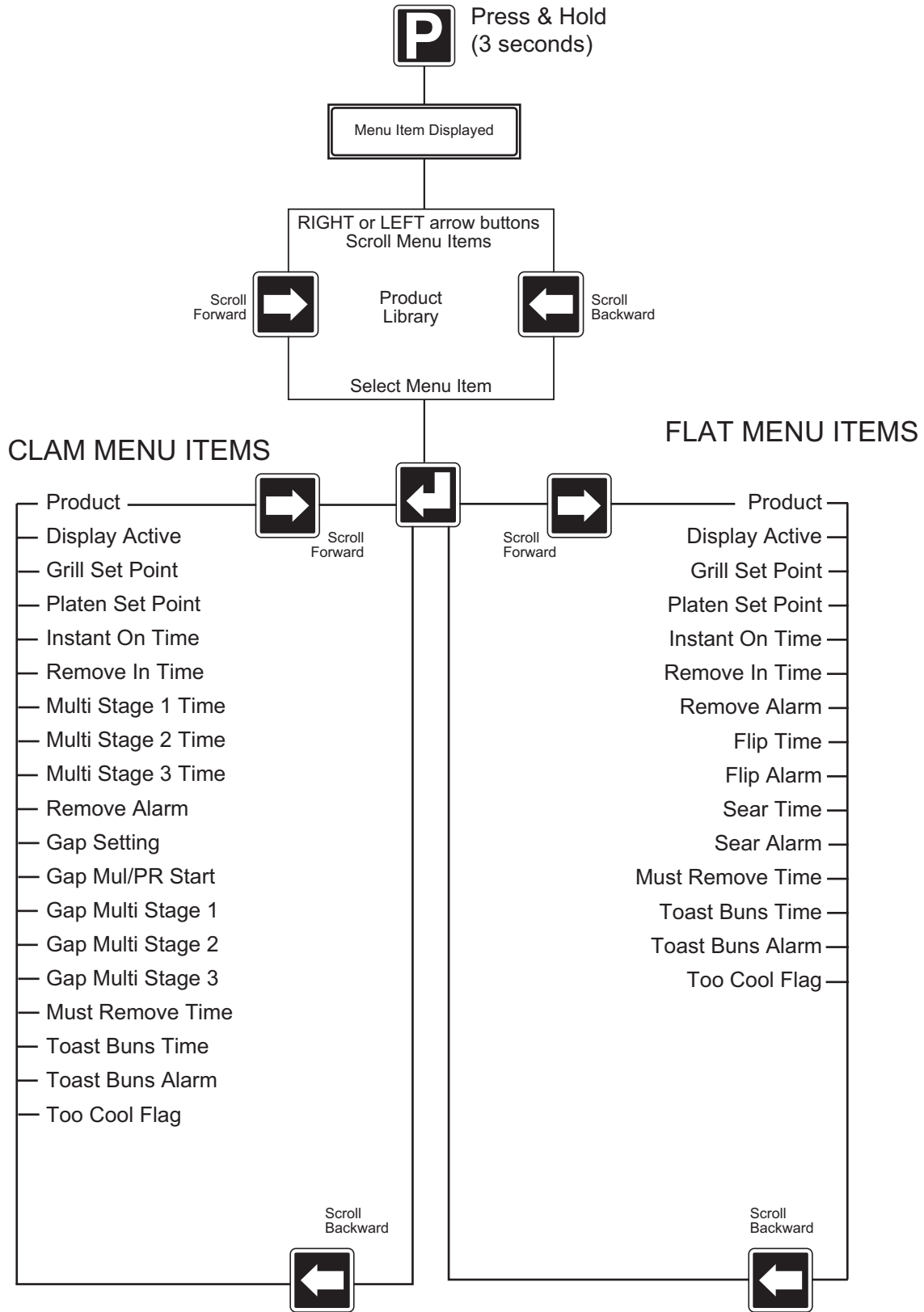

PROGRAM LOGIC TREE; SYSTEM MENUS

(software version 222)

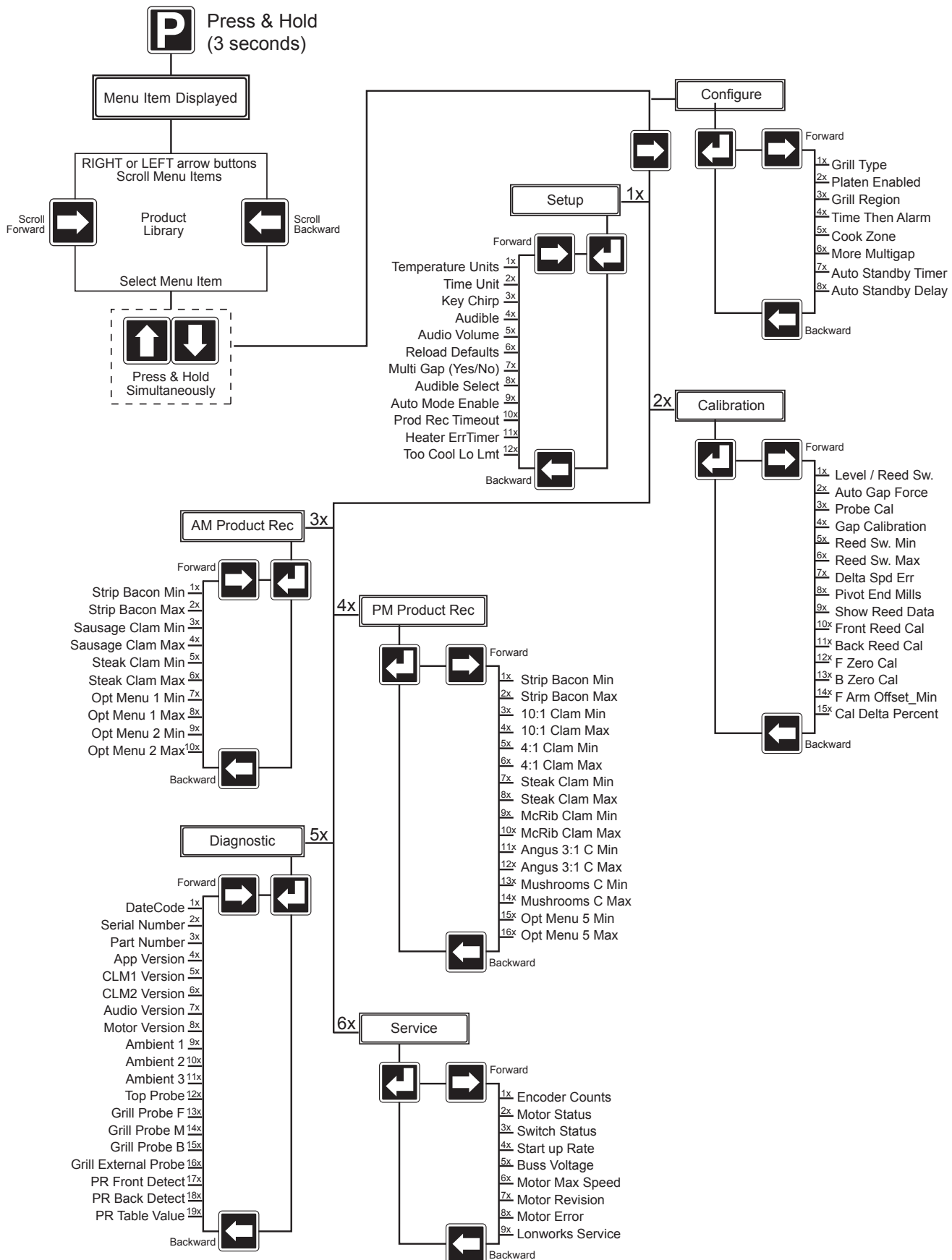

FUNCTION OPTIONS; SYSTEM MENUS (software version 222)

SOFTWARE V222

System Menu	Sub Menu	Options	Description of Options	Default
Configure Menu				
Grill Type	Electric Gas		Setting that tells control whether grill is electric or gas. Must be set correctly to identify number of heat zones.	Electric
Platen Enabled	Yes No		Setting in control that tells whether platen is present. I.E: Flat grills (No Platens).	Yes
Grill Region	World Japan		Setting to determine regional setup requirements.	World
Remove Alarm	Time Then Alarm Japan Fixed 10S			Time Then
Cook Zone	Left Center Right		Placement of control on grill.	Left
More Multi Gap	Yes No		Current requirements are for 2 stages of gap. This setting when set to Yes shows all 3 additional multi gap settings.	Yes
Auto Standby Timer	On Off		Turns on/off the automatic alarm to alert the operator to put grill in standby.	OFF
Auto Standby Delay	1-5		Seconds in which alarm will sound when alerting operator to put grill in standby.	3
Setup				
Temperature Units	F (Fahrenheit) C (Celsius)		Setting to display temperature units in Fahrenheit or Celcius.	F
Time Unit	sss mss mmm		Setting to display time Units: sss - Seconds mss - Minutes / Seconds (M-SS)	sss
Key Chirp	Yes No		Setting that turns the sound on/off when a button is pressed.	Yes
Audible	3 Second Strobe Song		Audible sound when remove alarm is sounding.	3 second
Audio Volume	1-100 (Adjustable)		Alarm volume	100
Reload Defaults	Yes No		When Yes is selected, the control will automatically begin to reload its factory defaults. In this setting, only menu item defaults are reloaded.	No
Multi Gap	Yes No		Enabled Multi Gap cooking on or off.	Yes
Audible Select	0 1 2		Pitch of tone in controller	1
Auto Mode Enable	Yes No		Enables or disables product recognition cooking in control.	Yes
Product Rec Timeout	0-30		Maximum number of seconds to recognize product. If product is not recognized in [Product Rec Timeout] time, then "Product Not Rec"	10
Heater Err Timer	60-1200		Number of seconds the controller must see a temperature rise before "Heater Error"	425
Too Cool Lo Lmt	OFF, 1F/C-450F / 250C			110F / 61C
Calibration				
Level / Reed Switch	Yes No		Mode where technician performs Platen Leveling procedure, and Reed Switch Calibration procedure	No
Auto Gap Force	Yes No		Mode where user can perform an Auto Calibration upon request.	No
Probe Cal	All Temperature Zones		Mode to perform a temperature probe calibration	
Gap Calibration	-1000 - 1000		Gap Offset - Offsets Gap setting for all menu items.	0
Reed Switch Min	0 - 1000		Maximum Δ CAL before warning / error msg	200
Reed Switch Max	0 - 1000		Maximum Δ CAL before disabling clam operation. Number corresponds to linear actuator motor speed.	300
Delta Speed Err	0-20		Adjusts automatically.	
Pivot End Mills	800 - 3000		Number set corresponds to location of pivot block to determine pivot point and decreased motor speed.	1100
Show Reed Data	YES/NO		When activated to YES, controller will display encoder counts when reed switches close.	No
Front Reed Cal	XXX		During Auto Calibration, the encoder counts when Front Reed Switch Closed.	
Back Reed Cal	XXX		During Auto Calibration, the encoder counts when Back Reed Switch Closed.	
F ZERO Cal	XXX		During Auto Calibration, the encoder counts when Front Reed Switch Opened.	
B ZERO Cal	XXX		During Auto Calibration, the encoder counts when Back Reed Switch Opened.	
F ARM OFFSET_MIN	-3000 - 1000		Calculated Offset of arm deflection.	-20
Cal Delta Percent	XXX		Factor of error calculated in control.	25%
Diagnostic				
Date Code	YYDDD		Date-of manufacturer	
Serial Number	XXXXXX		Serial No.	
Part Number	N3AF-XXX-XXX		Control Part Number	N2AF-0307-CNTL
App VERSION	XX.XX.XXX		Software Revision Number	04.01.202
CLM 1 Version	XX.XX.XXX		Control Loop Module Revision 1	01.00.046
CLM 2 Version	XX.XX.XXX		Control Loop Module Revision 2	01.00.046
Audio Version	XX.XX.XXX		Audio Code Revision	01.00.018
Motor Version	XX.XX.XXX		Motor Control Revision Number	06.00.034
Ambient 1	XXXX F/C		Actual Internal Temperature Ambient	
Ambient 2	XXXX F/C		Actual Internal Temperature Ambient (With Offset)	
Ambient 3	XXXX F/C		Actual Internal Temperature Ambient (With Offset)	
Top Probe	XXXX F/C		Actual Temperature Top Probe	
Grill Probe F	XXXX F/C		Actual Temperature Front Probe	
Grill Probe M	XXXX F/C		Actual Temperature Middle Probe	
Grill Probe B	XXXX F/C		Actual Temperature Back Probe	
External probe	XXXX F/C		Actual Temperature External Probe	
PR Front Detect	XXX		Last PR Value Detected By Front Reed Switch	OFF
PR Back Detect	XXX		Last PR Value Detected By Back Reed Switch	
PR Table Value	XXX		Last PR Table Value Calculated	
Service				
Encoder Counts	87-3500		Encoder Counts Brom Bottom Limit Sw Top Limit Sw	
Motor Status	xxx		Motor status Code - Operating Parameter	15
Switch Status	xxx		Switch Status Code - Operating Parameter	
Startup Rate	x		Startup Rate Code - Operating Parameter	8
Buss Voltage	198 +/- 10%		Controller Buss Voltage	
Motor Max Speed	64		Motor Max Speed Code	64
Motor Revision	xxx		Motor Revision	152
Motor Error	x		Motor Error Code - Operating Parameter	0
Lonworks Service	Yes / No		Lonworks Activated	NO

FACTORY DEFAULT SETTINGS (software version 222)

Clam Menu Items

Menu Item #	PRODUCT	DISPLAY ACTIVE	GRILL SET POINT	PLATEN SET POINT	INSTANT ON TIME	REMOVE IN TIME	MULTI STAGE TIME	REMOVE ALARM	GAP SETTING	GAP MULTI/PR START	GAP MULTI STAGE	MUST REMOVE IN TIME	TOAST BUNS IN TIME	TOAST BUNS ALARM	TOO COOL FLAG
1	10:1 - CLAM	PM	350°F (177°C)	425°F (217°C)	25	37	S1 5 S2 0 S3 0	AUTO	.255	.245	S1 .265 S2 0 S3 0	0	0	AUTO	NO
2	4:1 - CLAM	PM	350°F (177°C)	425°F (217°C)	30	107	S1 10 S2 --- S3 ---	AUTO	.415	.400	S1 .425 S2 --- S3 ---	0	0	AUTO	NO
3	STRIP BACON-CLAM	AM/PM	350°F (177°C)	425°F (217°C)	0	23	S1 --- S2 --- S3 ---	AUTO	.089	.089	S1 --- S2 --- S3 ---	0	0	AUTO	NO
4	SAUSAGE CLAM FZN	AM	350°F (177°C)	425°F (217°C)	0	82	S1 --- S2 --- S3 ---	AUTO	.350	.350	S1 --- S2 --- S3 ---	0	0	AUTO	NO
5	MCRIB - CLAM	NO	350°F (177°C)	425°F (217°C)	30	163	S1 --- S2 --- S3 ---	AUTO	.530	.530	S1 --- S2 --- S3 ---	0	0	AUTO	NO
6	STEAK-CLAM	AM/PM	350°F (177°C)	425°F (217°C)	0	104	S1 --- S2 --- S3 ---	AUTO	.415	.415	S1 --- S2 --- S3 ---	0	0	AUTO	YES
18	ANGUS 3:1 CLAM	PM	350°F (177°C)	425°F (217°C)	60	230	S1 --- S2 --- S3 ---	AUTO	.625	.625	S1 --- S2 --- S3 ---	0	0	AUTO	NO
19	MUSHROOM CALM	PM	350°F (177°C)	425°F (217°C)	60	104	S1 --- S2 --- S3 ---	AUTO	.415	.415	S1 --- S2 --- S3 ---	0	0	AUTO	YES

Flat Menu Items

	ITEM	DISPLAY ACTIVE	GRILL SET POINT	PLATEN SET POINT	INSTANT ON TIME	REMOVE IN TIME	REMOVE ALARM	FLIP TIME	FLIP ALARM	SEAR TIME	SEAR ALARM	MUST REMOVE IN TIME	TOAST BUNS TIME	TOAST BUNS ALARM	TOO COOL FLAG
7	GRILL CHICK-FLAT	PM	350°F (177°C)	425°F (217°C)	45	410	AUTO	195	MANUAL	---	---	---	---	---	YES
8	FOLDED EGGS-FLAT	AM	265 (130°C)	OFF	0	120	AUTO	---	NONE	---	---	---	---	---	NO
9	ROUND EGGS-FLAT	AM	265 (130°C)	OFF	0	150	AUTO	---	NONE	---	---	---	---	---	NO
10	CHICK F BRD-FLAT	NO	350°F (177°C)	425°F (217°C)	0	100	AUTO	---	NONE	---	---	---	---	---	NO
11	10:1- FLAT	NO	340°F (171°C)	425°F (217°C)	---	125	---	75	NONE	20	MANUAL	---	---	---	NO
12	4:1-FLAT	NO	365°F (185°C)	425°F (217°C)	---	270	---	150	NONE	20	MANUAL	---	---	---	NO
13	McRIB-FLAT	NO	365 (185°C)	425°F (217°C)	---	390	---	270	NONE	---	---	---	---	---	NO
15	HOTCAKES-FLAT	NO	365 (185°C)	425°F (217°C)	---	140	---	90	NONE	---	---	---	---	---	NO
	CLEAN MODE	AM/PM	325°F (163°C)	325°F (163°C)	---	---	---	---	---	---	---	---	---	---	NO

ERROR MESSAGES/TROUBLESHOOTING

DISPLAYED MESSAGE	MEANING	POSSIBLE CAUSES	POSSIBLE SOLUTION
GRILL PROBE ERROR	Error for grill temperature sensor	Wrong sensor type Poor termination Controller not setup for gas OR electric Open or damaged sensor Sensor is set below or above the controller operating range	Identify sensor as "ungrounded type" Review wiring instructions Check configuration Continuity check Is high limit device activated?
PLATEN PROBE ERROR	Error for platen temperature sensor	Wrong sensor type Poor termination Controller not setup for gas OR electric Open or damaged sensor Sensor is set below or above the controller operating range	Identify sensor as "ungrounded type" Review wiring instructions Check configuration Continuity check Is high limit device activated?
ERROR AMBIENT	Too low or too high temperature at the controller	Ambient is lower than 32 deg F or higher than 176 deg F	Check ventilation of controller area
ERROR COLD START	EEPROM response issue	EEPROM initializing for the very first time EEPROM malfunction	Wait for 30 seconds for message to disappear If message fails to clear controller is suspect
CHECK REED SWITCH USE FLAT COOK	Platen failed to calibrate, can cook in flat mode	Either of the two reed switches are closed when they should be open	Reset reed switch positions in calibration menu
CHK PLATEN LEVEL	Warning that platen level needs checked	Calibration difference between the front and rear reed switch is greater than the REED SWITCH MIN but less than the REED SWITCH MAX in the calibration menu	Recalibrate reed switches in the calibration menu
PLATEN NOT LEVEL	Platen not level	Calibration difference between the front and rear reed switch is greater than the REED SWITCH MAX	Recalibrate reed switches in the calibration menu
ERROR DOWN	Platen fails to move down or is not moving within 40 seconds	Encoder cable not attached Platen movement obstruction Motor malfunction Motor control board malfunction	Check pin connection on motor control board Remove utensils, check exhaust hood clearance, check for grease build up on shafts Check voltage to motor Check voltage to motor control board
ERROR UP	Platen fails to move up or is not moving within 40 seconds	Encoder cable not attached Platen movement obstruction Motor malfunction Motor control board malfunction	Check pin connection on motor control board Remove utensils, check exhaust hood clearance, check for grease build up on shafts Check voltage to motor Check voltage to motor control board
ERROR COMMS	Communication problem between motor control and main controller	Controller does not detect 3 consecutive commands from motor control board	Check cable connection on both boards and voltage to motor control board
IGNITION FAILURE	Burner flame not detected	Gas not turned on to grill No spark from ignitor Blower malfunction Air switch malfunction Gas valve not opening Ignition module malfunction Air still in the gas line when reconnected	Check gas valve on supply line and hose connection Check ignitor wire connections Check voltage at blower motor Check voltage at switch, check for pinched air hose Check voltage at valve listen for valve operation Check voltage at inputs & outputs of ignition module Retry by cycling controller off and on
HIGH TEMP PLATEN/GRILL	Platen or grill platen temperature is higher than 465 deg F	Probe calibration not correct Operational procedures not being followed (e.g. no scraper and squeegee) Stuck closed solid state relay Gas pressure too high	Recalibrate temperature zone Review procedures when message is displayed Check for lit LED on Solid State Relay that should be off Check that manifold pressure is 3.5" W.C. Allow temperature to cool before operation

ERROR MESSAGES/TROUBLESHOOTING *(continued)*

DISPLAYED MESSAGE	MEANING	POSSIBLE CAUSES	POSSIBLE SOLUTION
HEAT ERROR PLATEN/GRILL	No temperature increase within 425 seconds after dropping below set point	Shorted temperature sensor Solid state relays are not on Loss of power to platen Operational procedures not being followed (e.g. no scraper and squeegee)	Continuity check to ground Verify harness connections to controller Check operation of main contactors Review procedures when message is displayed
MOTOR GEN ERR	One of five errors associated with the motor or motor control board has occurred	Communication problem between motor control board and the main controller Motor control board timing is interrupted or not correct	Check cabling between encoder & motor speed controller & between motor speed controller & main controller Cycle main power OFF and ON
MOTOR ENCOD ERR	The encoder has "jumped" or missed a pulse	Loose wiring on encoder Loose encoder connection at the motor Unstable power source	Check wiring connections Check wiring and assembly of encoder Check incoming voltage
MOTOR OVER AMPS	Motor current exceeded 4 amps (software is protecting motor speed control board)	Interference within lift mechanism	Check for platen obstructions Clean excess grease from actuator shafts & replace seals if necessary Clean grill daily per operational instructions
MOTOR CLS STOP	The encoder has detected 31 counts below the "zero" reference point	Lower limit switch not in correct position or defective Platen adjustment has become loose	Recalibrate lower limit switch operation to the correct "zero" position, check for proper limit switch operation Check fasteners on key lift components
MOTOR SPD ERR	Controller detects that the platen is not moving	Actuator failure Loose encoder or motor connections	Check actuator function and replace if defective Check all connections on motor speed control board and the actuator motor
MOTOR BUSLV ERR	The DC voltage on the motor control board dipped below 95 vdc	Incoming voltage drop from AC source Transient voltage issue	Recycle main power to grill to reset motor speed controller settings Measure incoming voltage where motor connects to motor control board
MOTOR BUSSV ERR	The DC voltage on the motor control board is either under or over preset limits	Incoming voltage drop or surge from AC source Transient voltage issue	Recycle main power to grill to reset motor speed controller settings Measure incoming voltage where motor connects to motor control board
MOTOR PINCH ERR	The maximum or minimum platen speed difference is greater than a preset value	Obstruction to platen movement Interference with the lift mechanism Encoder error	Check for platen obstructions Clean excess grease from actuator shafts and replace seals if necessary Check encoder wiring connections Clean grill daily per operational instructions
MOTOR MSE ERR	The motion values for the platen have been exceeded	Obstruction to platen movement Interference with the lift mechanism Encoder error	Check for platen obstructions Clean excess grease from actuator shafts and replace seals if necessary Check encoder wiring connections Clean grill daily per operational instructions
MOTOR SPEED ERR	No level speed after 750 msec	Obstruction to platen movement Interference with the lift mechanism Encoder error	Check for platen obstructions Clean excess grease from actuator shafts and replace seals if necessary Check encoder wiring connections Clean grill daily per operational instructions

PROBE CALIBRATION

Monthly Calibration of Grill Temperature Zones

Tools: Digital Pyrometer with Surface Probe

Warning: PERSONAL INJURY FROM BURNS MAY RESULT WHEN COMING IN CONTACT WITH HOT COOKING SURFACES.

NOTE: Probe Calibration of grills is done with release material sheets "OFF".

PLEASE FOLLOW THESE INSTRUCTIONS EXACTLY AS THEY APPEAR BELOW:

1. The upper platens and lower grill plate should be at operating temperatures to perform this calibration procedure. Press the or button to select a "CLAM" operation and allow the grill to reach the set temperature and stabilize, (approximately 30 minutes).
2. PRESS and HOLD the button for approximately 3 seconds, or until the controller will display: "PROBE CAL".
3. PRESS the button to display the first temperature zone to be calibrated. The first zone to be calibrated is "FRONT TEMP CAL". The zones are displayed in order of FRONT TEMP CAL, MIDDLE TEMP CAL, BACK TEMP CAL, TOP TEMP CAL.

MWE3W: The electric grill's thermocouple probes are located front to rear, as shown in the diagram to the right. Each upper platen has one thermocouple in the center.

MWG3W: The gas grill's thermocouple probes are located in the center of each lane, as shown in the diagram to the right. Each upper platen has one thermocouple in the center.

4. Select a heat zone display using the or buttons.
5. Allow at least 5 seconds for the pyrometer to respond and stabilize. Note the temperature on the pyrometer.
6. If the temperature on the grill control display does not match the temperature on the pyrometer, adjust the temperature on the grill control accordingly. The button will increase the displayed temperature in one, (1) degree increments. The button will decrease the displayed temperature in one, (1), degree Increments.

NOTE: During step 6, the control should be sounding a high-pitched tone. The temperature can only be adjusted if this tone is sounding. If the control is silent, the temperature will not change.





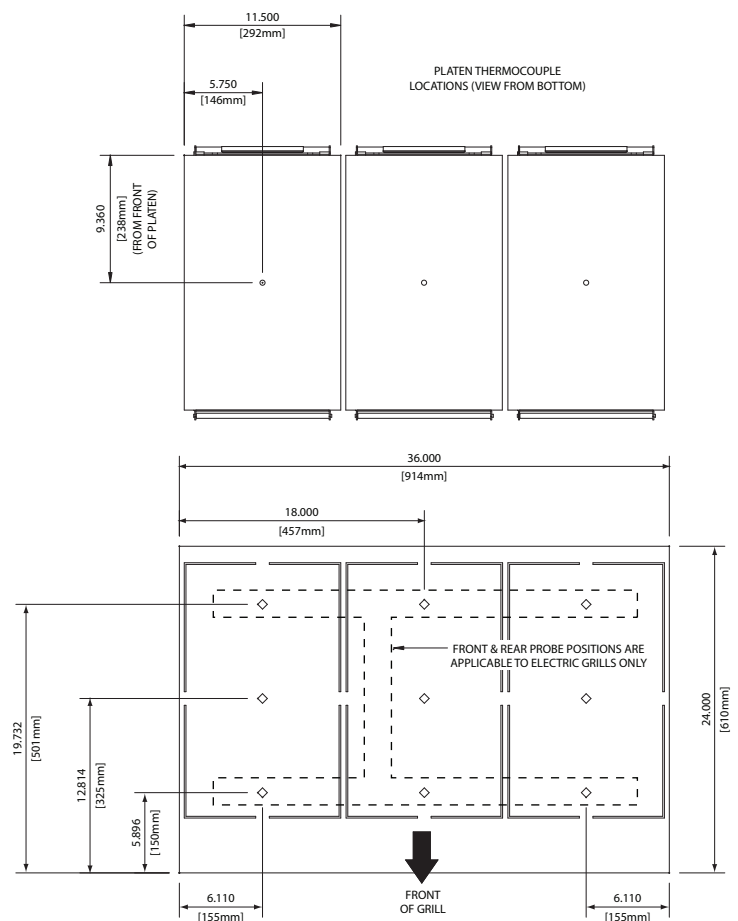



7. PRESS the button to lock the calibrated temperature into the controller.
8. Press the or button to select the next heat zone.
9. Move the pyrometer's surface probe to the newly selected heat zone and repeat steps 5, 6, and 7.
10. Repeat the procedure for each of the heat zones.
11. Continue to cycle through each heat zone repeating the sequence until all temperatures are within 1°.
12. Exit the program mode by pressing the button 2x. The controller will return to its previous state in the Normal Operating Mode.

THERMOCOUPLE LOCATIONS



PLATEN LEVELING (ZEROING)

In order to ensure that the platen reed switches are in their proper location, you must ensure that the distance of the magnet is the correct distance away from the switch (located inside the upper platen).

- 1) Enter the "LEVEL/REED SW" Mode"
 - a) With the controller display ON and either displaying the current menu item or displaying "OFF", PRESS and HOLD the  button for approximately 3 seconds. Controller will display the previously selected menu item and its corresponding item number OR "Standby / Menu Item".
 - b) PRESS the  AND  arrow buttons TOGETHER. "CONFIGURE" will appear in the display.
 - c) PRESS the  2X. "CALIBRATION" will appear in the display.
 - d) PRESS the  button. "LEVEL/REED SW" will appear in the display.
 - e) PRESS the  button. "NO" will begin to flash.
 - f) PRESS the  button. "NO" will change to "YES".
 - g) PRESS the  button. "YES" will stop flashing.
 - h) Ensure the grill surface is free of objects and debris, then press the  GREEN pushbutton to lower the platen.

- 2) Using a flat screwdriver or the Platen Adjusting tool, remove the platen adjuster grease caps.
- 3) Using a flat screwdriver or the Platen Adjusting tool, Remove the platen adjuster locking caps.

4) Adjust Platen:

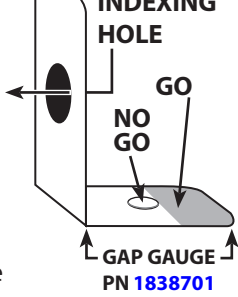
- a) Using a flat screwdriver or the Platen Adjusting tool, adjust rear of platen until the Gap Gauge fits snugly between the upper platen and grill surface. The Gap Gauge should fit snugly under the platen, but STOP at the raised emboss on the gapping tool (No-Go).
 
- b) Move next to the front adjustment and raise or lower the front of the upper platen until the Gap Gauge fits snugly between the upper platen and grill surface. The front of the platen has only a SINGLE-POINT adjustment. Fit the Gap Gauge under the front of the platen, and adjust until both sides gauge equally.

- 5) After adjusting the upper platen, YOU MUST ADJUST AND SET THE UPPER PLATEN REED SWITCHES. Proceed to section titled "TO SET THE REED SWITCHES" on page 41.





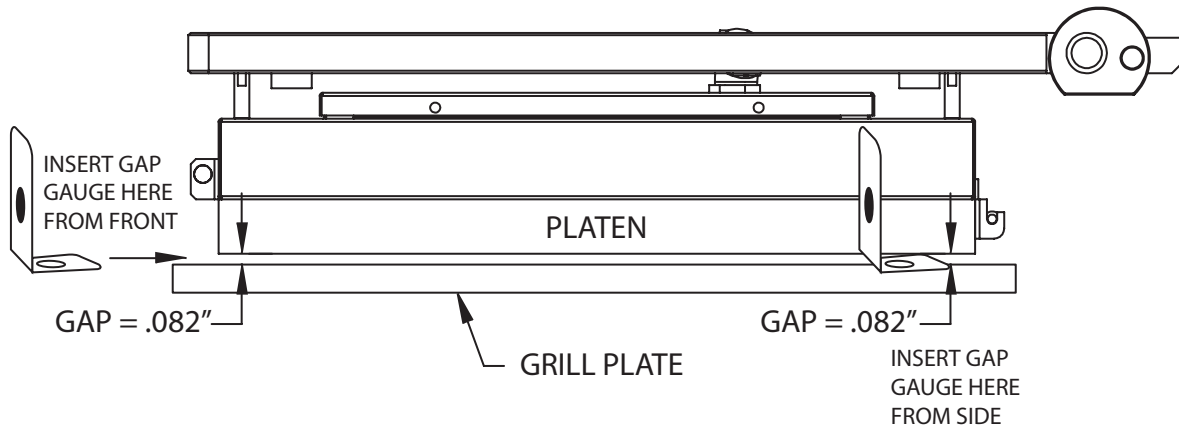











Platen Adjusting Tool
PN 4523323



PLATEN SIDE VIEW

TO SET THE REED SWITCHES

In order to ensure that the platen reed switches are in their proper location, you must ensure that the distance of the magnet is the correct distance away from the switch (located inside the upper platen).

- 1) Enter the "LEVEL/REED SW" mode:
 - a) With the controller display ON and either displaying the current menu item or displaying "OFF" PRESS and HOLD the  button for 3 seconds. Controller will display previously selected menu item and its corresponding item number OR "Standby / Menu Item".
 - b) PRESS the  AND  arrow buttons TOGETHER. "CONFIGURE" will appear in the display.
 - c) PRESS the  2X. "CALIBRATION" appears.
 - d) PRESS the  button. "LEVEL/REED SW" appears.
 - e) PRESS the  button. "NO" will begin to flash.
 - f) PRESS the  button. "NO" will change to "YES".
 - g) PRESS the  button. "YES" will stop flashing.
 - h) Press the  GREEN button to lower the platen.
- 2) Remove the reed switch grease caps.
- 3) Remove the reed switch locking caps.
- 4) Using the Platen Adjusting Tool, screw the magnet down (clockwise) UNTIL the controller sounds a hi pitched BEEP.
- 5) Screw the magnet UP (counter-clockwise) UNTIL the hi-pitched BEEP STOPS.
- 6) Screw the magnet counter-clockwise one, (1), more full turn (360°).
- 7) Repeat the procedure for the opposite reed switch.
- 8) After setting the reed switches as described, you must perform a Forced Auto Calibration. Press the  GREEN button to raise the platen.
- 9) PRESS  until "AUTO GAP FORCE" appears.
- 10) PRESS the  button. "NO" will begin to flash.
- 11) PRESS the  button. "NO" will change to "YES".
- 12) PRESS the  button. The platen will immediately lower and reset its internal measurements.

TO CHANGE THE REED SWITCH

Warning: Reed switches carry high voltage. Isolate grill from all electrical power. Disconnect Power Cords.

1. Remove Platen Cover.

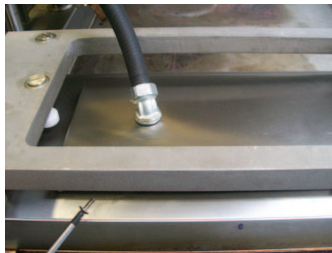

2. Remove Wire Nuts from reed switch leads.

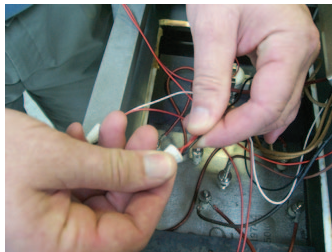

3. Mark wires for easy reconnection.

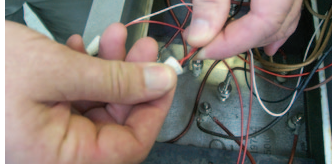

4. Remove reed switch bracket with 5/64 allen wrench.

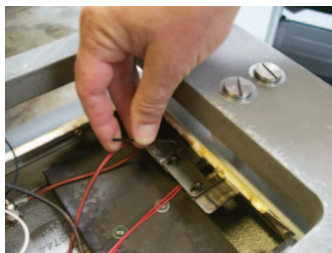

5. Install new reed switch on the bracket, aligning its edges with the edges of the bracket, as shown.

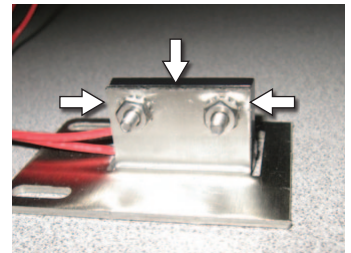

6. Confirm that your positioning gauge is in-square by checking it against the corner of the platen arm as shown. Bend for compliant fit if necessary.



7. Reinstall reed switch bracket using the positioning gauge. Align pushing in the direction shown, and tighten securely.

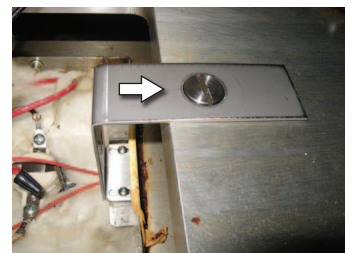



8. Reconnect wires with wire nuts, and reinstall the Platen Cover.

REED SWITCH OPERATION

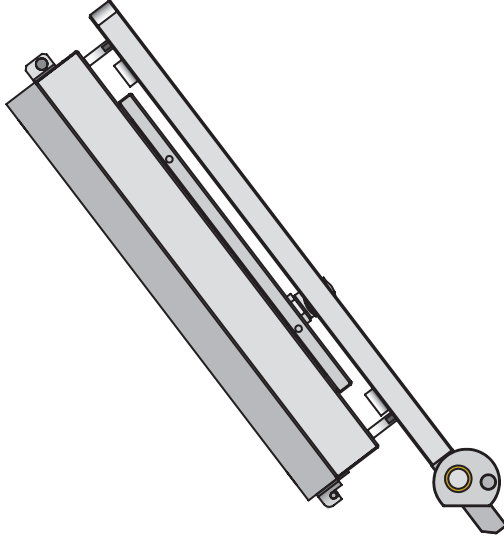
The Motor Speed Control is equipped with LED lights that indicate the state of the reed switches (Both Front and Rear), and the Limit Switches (Both Upper and Lower). The LED light is ON when the state of the switch is OPEN. The LED light is OFF when the state of the switch is CLOSED. (LED colors may vary.)



-  = LED not lighted / Switch Is CLOSED
-  = LED lighted / Switch Is OPEN

PLATEN UP

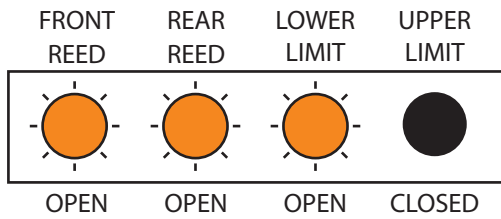
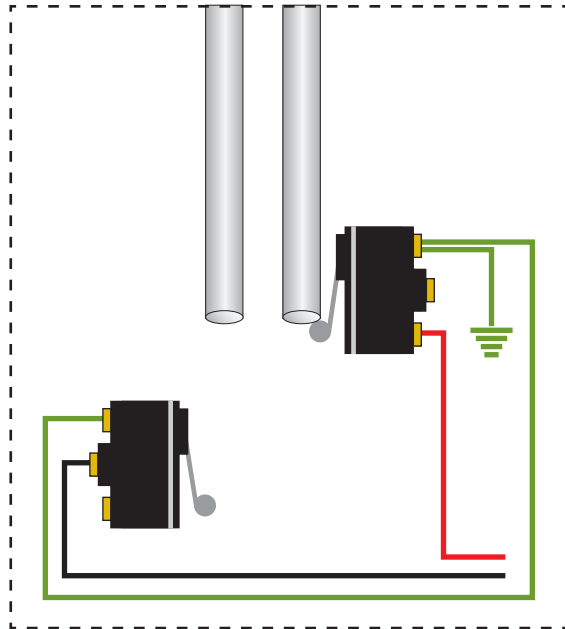



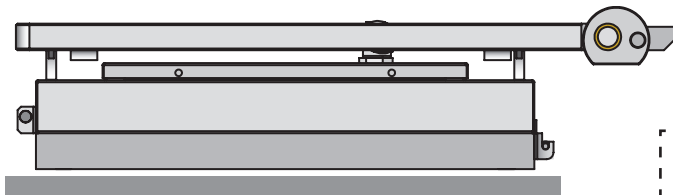



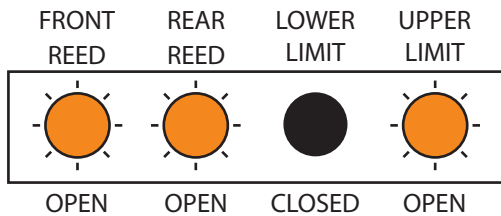
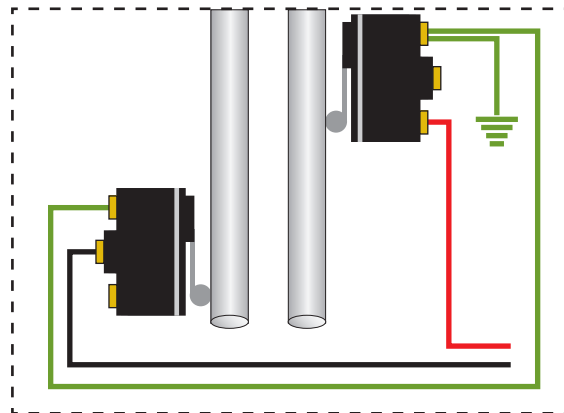





































NORMAL state of the switches when the platen is in the UP position.



PLATEN DOWN



REED SWITCH OPERATION *(continued)*

FRONT REED	REAR REED	LOWER LIMIT	UPPER LIMIT	
 OPEN	 OPEN	 OPEN	 CLOSED	Platen in the Up Position – Switches are in NORMAL state.
 OPEN	 OPEN	 OPEN	 OPEN	Platen movement command has been initiated. Upper Limit switch as OPENED.
 OPEN	 OPEN	 CLOSED	 OPEN	Platen has moved to the DOWN position. Lower Limit switch has CLOSED.
 OPEN	 OPEN	 OPEN	 OPEN	Platen has raised up to PREHEAT GAP SETTING of .450. Lower Limit Switch OPENS.
AUTO CALIBRATION BEGINS AFTER GRILL REACHES TEMPERATURE AND COUNTDOWN TIMER EXPIRES.				
 OPEN	 OPEN	 CLOSED	 OPEN	Auto calibration begins. Lower Limit Switch CLOSES
 OPEN	 CLOSED	 CLOSED	 OPEN	Platen continues to move down. Rear Reed Switch CLOSES.
 CLOSED	 CLOSED	 CLOSED	 OPEN	Platen continues to move down. Front Reed Switch CLOSES.
 OPEN	 CLOSED	 CLOSED	 OPEN	Linear Actuator reverses polarity. Platen Raises. Front Reed Switch OPENS.
 OPEN	 OPEN	 CLOSED	 OPEN	Platen continues to rise. Rear Reed Switch OPENS.
 OPEN	 OPEN	 OPEN	 OPEN	Platen continues to rise. Lower limit switch opens.
 OPEN	 OPEN	 OPEN	 CLOSED	Platen continues to rise. Upper Limit switch OPENS. Movement stops.

REED SWITCH OPERATION *(continued)*

Explanation of calibration numbers, auto calibration, and other Reed Switch variables.

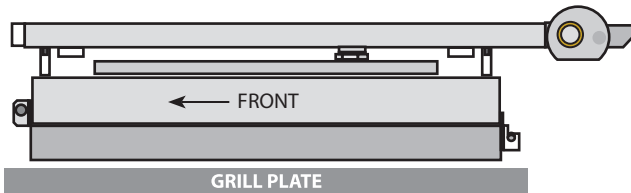

44.1: PLATEN IN THE PARALLEL POSITION

After the platen reaches the parallel position (44.1), the actuator will continue to run bringing the platen to a resting position on the grill plate as shown (44.2).

Once the platen is resting on the grill surface, the linear actuator will continue to run, lowering the platen arm even more, causing the shoulder bolts to ride up into the arm. **This is the reason why the lock nuts are hollowed out all the way through.**

While the platen arm is lowering, the rear reed switch is closed when it makes contact with the magnet mounted on the arm. The number of counts from 0 gets stored in the control as **BACK REED CAL.** (44:3).

The linear actuator will continue lower bringing the platen arm down until the front reed switch makes contact with the magnet. The number of counts from 0 gets stored in the control as **FRONT REED CAL.** (44:4).

The timeline (44.5), shows negative actuator movement, (platen arm downward), and the sequence in which different reference points are achieved. Point **1** represents the number of encoder counts from 0 at which the **rear** reed switch closed (or made contact with the magnet). **2** is the number of encoder counts from 0 that the **front** reed switch closed (or made contact with the magnet).

IMPORTANT – The number of encoder counts between points 1 & 2 is **DELTA CAL (Δ CAL)**. Δ CAL must be **below 200**. The following conditions apply:

Δ CAL < 200: OK

Δ CAL > 200, < 300: “Check Platen Level” (Disables Auto Mode, allows operation in Manual Mode only.)

Δ CAL > 300: “Platen Not Level / Use Flat Cook” (Disables all clamshell cooking.)

During auto calibration, after the front reed switch is made, polarity and actuator direction are reversed, (44.6). The actuator raises the platen arm, referencing point **3** when the **front** reed switch reopens, as **FRONT ZERO CAL.** Point **4**, when the **rear** reed switch opens, is recorded as **BACK ZERO CAL.**

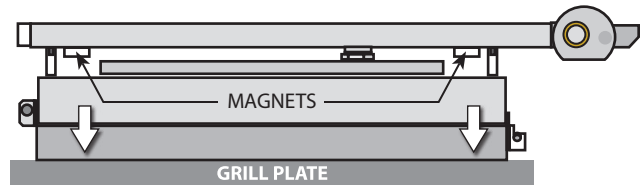

44.2: PLATEN RESTING ON GRILL PLATE

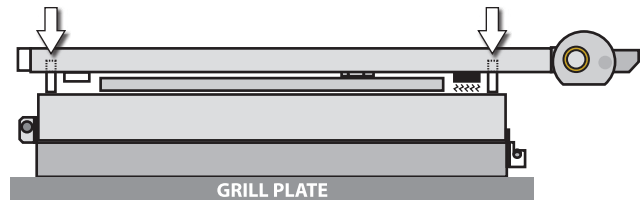

44.3: REAR REED SWITCH MAKING, SHOULDER BOLTS RECESSED INSIDE THE PLATEN ARM. **REAR REED CAL SET AND STORED IN CONTROLLER CALIBRATION MENU.**

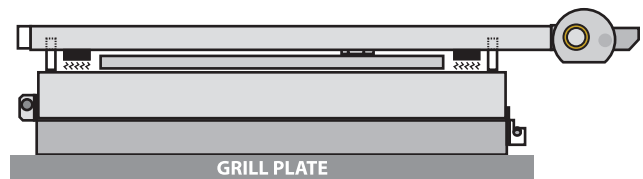

44.4: FRONT REED SWITCH MAKING, SHOULDER BOLTS RECESSED INSIDE THE PLATEN ARM. **FRONT REED CAL SET AND STORED IN CONTROLLER CALIBRATION MENU.**

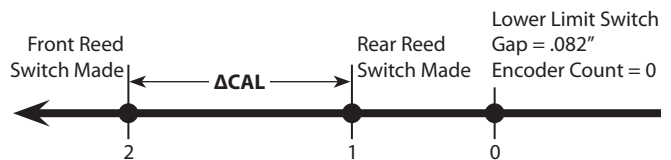

44.5: NEGATIVE LINEAR ACTUATOR MOVEMENT

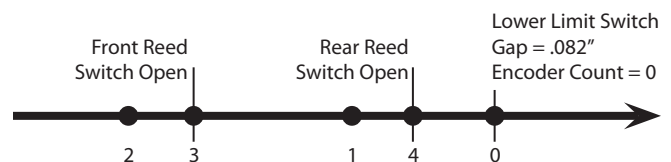

44.6: POSITIVE LINEAR ACTUATOR MOVEMENT

TO CHANGE THE MAGNET ASSEMBLY

1. Remove grease cap and lock nut.



2. With a Phillips head screwdriver, screw magnet CLOCKWISE out of the bottom of the platen arm assembly.



3. If the magnet does not clear the platen arm assembly, lower the gap adjustment in the front to give clearance for the magnet assembly.



4. Install new magnet assembly from the bottom up. ENSURE PROPER SEATING. CROSS THREADING CAN OCCUR.

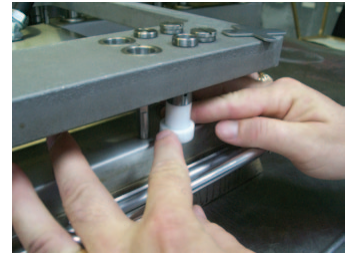

5. Perform platen leveling procedure.
6. Perform reed switch calibration procedure, (see section titled "TO SET THE REED SWITCHES" on page 41).

TO REPLACE THE LINEAR ACTUATOR

1. Disconnect the cable from the Motor Speed Control.

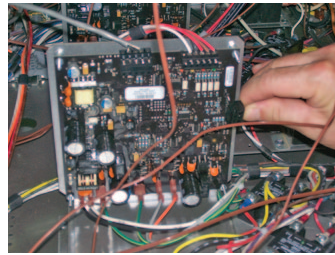

2. Disconnect the motor leads from the wire harness.

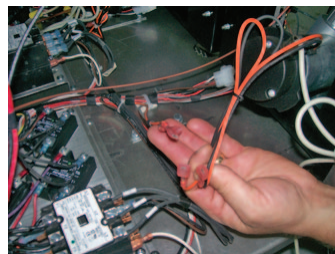

3. With the platen in the UP position, support it with a pry bar, 2x4, etc., from behind the platen arm assembly. Pull the platen arm toward the rear of the grill to insert.

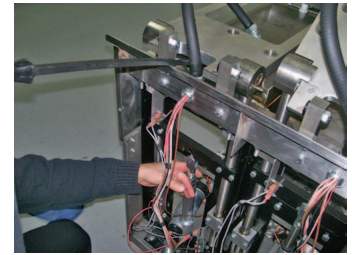

TO REPLACE THE LINEAR ACTUATOR (continued)

4. With the weight of the platen supported by the object inserted in step 3, use pliers to work the clevis pin retaining clip outward, making sure to grip it as close to the pin as possible to prevent deforming it.

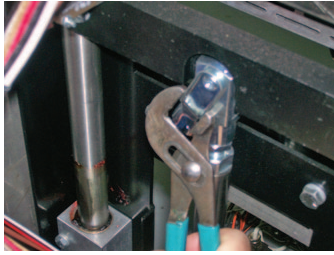

5. Use the pliers to remove the spring clip from the pin at the base of the Linear Actuator.

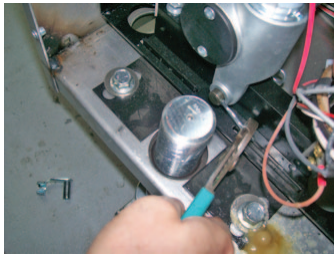

6. Push the pin through the actuator base toward the inside of the grill. Reach around to the inside and remove.



7. Remove the Linear Actuator from the grill, carefully pulling it out the rear.



8. Support the weight of the platen while removing the pry bar. Then, carefully lower platen to the down position, resting it on the grill plate.

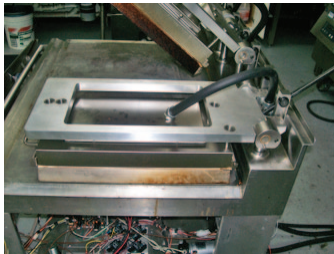

9. Screw NEW linear actuator shaft down approximately 2 turns from bottoming out. DO NOT completely bottom out shaft as it may not be long enough to reconnect the upper clevis clip.



10. Re-install linear actuator into rack assembly. If motor does not clear the cross member, use pry bar to gently lift and fit as previously done in step 3. Reinstall actuator base pin from inside and remount its spring clip.

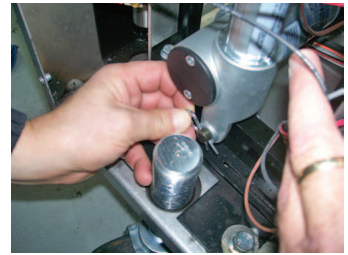
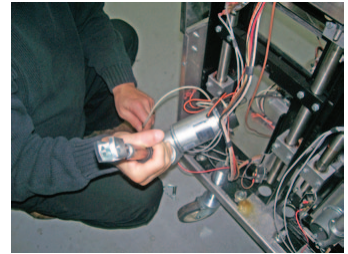

11. Gently fit clevis clip through top of actuator shaft and cross member bar. Use pry bar to align holes.

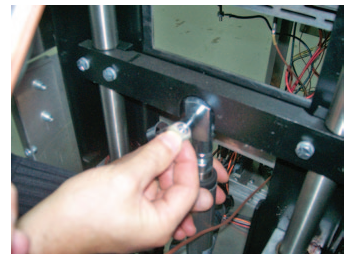

12. Reconnect wires as shows in the photos to the right.

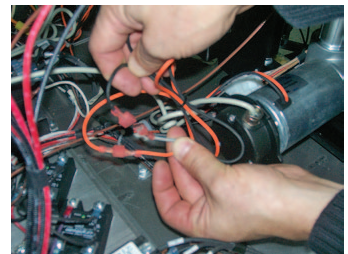
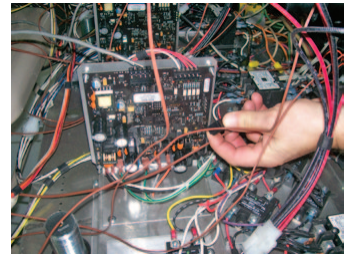

TO UPDATE CONTROL SOFTWARE (main control)

THE FOLLOWING INSTRUCTIONS ARE FOR USE WITH THE GARLAND ZIPGRADER TO UPLOAD NEW CONTROL SOFTWARE INTO WATLOW CONTROL (PN 4522735) AND WATLOW MOTOR CONTROL (PN 4521682.)

To connect and upgrade main control (pn 4522735)

1. Remove control and kick panels. Replace control panel.
 - a. Remove control panel screws to release control panel.
 - b. Carefully push up and release control panel from kick panel.
 - c. Remove kick panel, and place on floor.
 - d. Replace control panel on grill chassis frame.



2. Attach telephone cable to ZipGrader & Control.
 - a. Attach one end of cable to ZipGrader.
 - b. Attach opposite end of cable to controller. Control jack is on the bottom side of the controller.

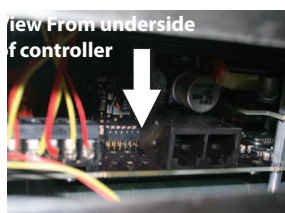

3. Enter programming mode by:
 - a. PRESS AND HOLD the TEMP & CLOCK buttons on the control. Turn main power switch on WHILE HOLDING two buttons in. Hold for approximately 3 seconds. Control will turn on as normal.
 - b. Turn main power switch OFF and wait for 10 seconds.
 - c. Turn main power switch ON. Control should read something similar to "MOD BOOT".



4. Begin uploading software by:
 - a. Press ZipGraders BLUE button.
 - b. Monitor Serial Link and progress LED's as indicated on the back of the ZipGrader.



5. Control upgrade is complete when the control displays FULL DEFAULT and then returns to the OFF position. WAIT FOR THE CONTROL ZIPGRADER TO AUTOMATICALLY TURN OFF.
6. Turn main power switch OFF.



7. Remove RJ12 telephone cable from control, and insert into additional controls. Repeat steps 4 through 7 until complete.

TO UPDATE CONTROL SOFTWARE (motor control)

1. Remove control and kick panels. Replace control panel.
 - a. Remove control panel screws to release control panel.
 - b. Carefully push up and release control panel from kick panel.
 - c. Remove kick panel, and place on floor.
 - d. Carefully place control panel on top of the kick panel to avoid excessive wire tension.



2. Attach Telephone Cable to ZipGrader & Motor Control
 - a. Attach Telephone Cable to ZipGrader (if not done already).
 - b. Attach opposite end of cable to Motor Control adapter kit.
 - c. Remove 4-pin Riacon Connector COMM CABLE from Motor Control.
 - d. Replace 4-pin Riacon Connector from attached ZipGrader to Motor Control.

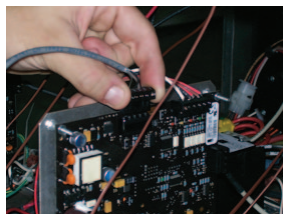
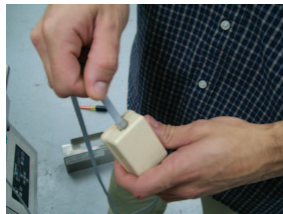

3. Begin uploading software by:
 - a. Press ZipGraders BLUE button.
 - b. Turn grill Power ON via Main Power Switch.



- NOTE: Control will alternately flash ERROR COMMS
- c. Motor Serial Link and Progress LED's as indicated on back of ZipGrader.



4. Allow ZipGrader to turn off automatically.
5. Turn Main Power switch to OFF position.
6. Remove 4-pin Riacon connector from ZipGrader, and replace with 4-pin Riacon connector COMM CABLE previously removed.
7. Repeat steps 3c to 6 until complete.
8. Carefully replace bottom kick panel, and control panel and return unit to service:
 - a. Turn main power switch ON.
 - b. Press POWER ON button on Main Control.
 - c. Platens will automatically come down and into PREHEAT MODE.
 - d. Switch controls to desired time of day by pressing AM/PM button.
 - e. Allow unit to reach set temperature and autocalibrate.
 - f. Verify proper beef integrity and adjust cook times as needed in MANUAL MODE.

FLEXIBLE GAS LINE REPLACEMENT

THE FOLLOWING INSTRUCTIONS AND WARNINGS ARE FOR THE SAFETY AND SECURITY OF ALL PERSONNEL INCLUDING THE SERVICE TECHNICIAN. ANY DEVIATION OR VARIANCE FROM THE BELOW INSTRUCTIONS CAN BE EXTREMELY HARMFUL AND WOULD COMPROMISE THE SAFETY OF ALL PERSONNEL. FOLLOW THE BELOW INSTRUCTIONS CAREFULLY AND DO NOT DEVIATE FROM ANY KEY POINTS BELOW.

BEGINNING WITH SERIAL NUMBERS 0910100200875, THE USE OF RIGID HARD GAS LINES REPLACED FLEXIBLE GAS LINES (SEE "PARTS ID: GRILL BURNER; GAS MODELS" on page 56). WHEN REPLACING FLEXIBLE GAS LINES, A REPLACEMENT FLEXIBLE GAS LINE IS AVAILABLE (PN [CK4527827](#)).

1. DO NOT USE PIPE DOPE, TEFLON TAPE, OR ANY OTHER SEALING COMPOUND ON THE FLARE SEAT
2. DO NOT OVER TIGHTEN FITTINGS

WARNING ALWAYS USE TWO WRENCHES, ONE ON THE TUBE AND ONE ON THE MATING FITTING, WHEN TIGHTENING OR REMOVING A TUBE.

DO NOT ALLOW THE END OF A TUBE TO ROTATE MORE THAN 45 DEGREES WHILE TIGHTENING. REMOVE AND DISCARD ANY TUBE THAT DOES.

3. THE TUBE IS DESIGNED TO BE EASILY BENT FOR INSTALLATION, BUT IS NOT DESIGNED FOR REPEATED BENDING, MOVEMENT OR VIBRATION

WARNING EXCESSIVE BENDING, MOVEMENT OR VIBRATION AFTER INSTALLATION CAN LEAD TO LEAKAGE.

BENDS SHOULD NOT BE TIGHTER THAN A $\frac{3}{4}$ INCH RADIUS (SIZE OF A GOLF BALL).

DO NOT STRAIGHTEN A TUBE THAT HAS BEEN BENT TOO TIGHT DISCARD AND USE A NEW TUBE.

ALIGN THE TUBE TO THE FITTING BEFORE INSTALLING TO ELIMINATE ANY UNNECESSARY BENDING OF THE TUBE AS THE NUT IS TIGHTENED DOWN.

DO NOT BEND A TUBE AFTER INSTALLATION.

4. AVOID CONTACT BETWEEN THE FLEX-TUBE AND OTHER OBJECTS SUCH AS SHEET METAL, WIRING, OTHER TUBING AND OBJECTS WITH SHARP EDGES.
5. DO NOT RE-USE A TUBE THAT HAS BEEN DISCONNECTED AT EITHER END OR REMOVED FOR ANY REASON (REPLACEMENT OF MATING COMPONENT) A NEW TUBE SHOULD ALWAYS BE INSTALLED.

THE PHOTO TO THE RIGHT IS A DEPICTION OF A COMPROMISED FLEXIBLE GAS LINE. IN THIS PHOTO, THE FITTINGS HAVE BEEN OVERTIGHTENED CAUSING STRESS ON THE FITTINGS AND THE TUBE.

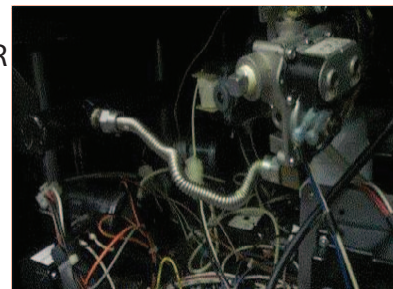

ELECTRIC HEATING ELEMENTS (1 of 3 cooking lanes shown)

UPPER PLATEN ELEMENTS: ALL GRILLS



3249 WATTS TOTAL (3 ELEMENTS @ 1083 WATTS EA)			
VOLTS	LINE AMPS	ELEMENT AMPS	RESISTANCE
208	9.02	5.20	33.95 Ω
220	8.53	4.92	44.69 Ω
240	7.82	4.51	53.20 Ω

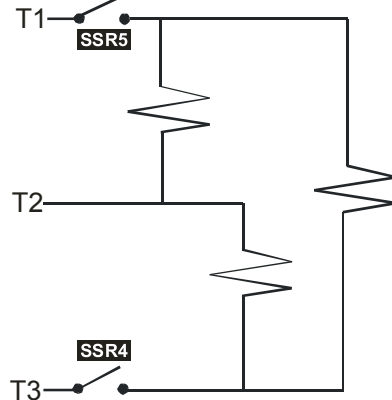
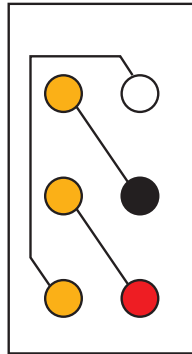

GRILL SURFACE ELEMENTS: MWE3W

VOLTS	LINE AMPS	ELEMENT AMPS	RESISTANCE
FRONT/REAR ELEMENTS: 1300 WATTS EA.			
208	6.25	6.25	33.28 Ω
220	5.91	5.91	37.23 Ω
240	5.42	5.42	44.28 Ω
CENTER ELEMENT: 1700 WATTS			
208	8.17	8.17	25.46 Ω
220	7.72	7.72	28.50 Ω
240	7.08	7.08	33.90 Ω

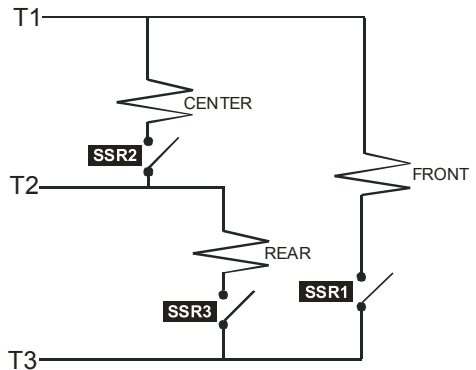
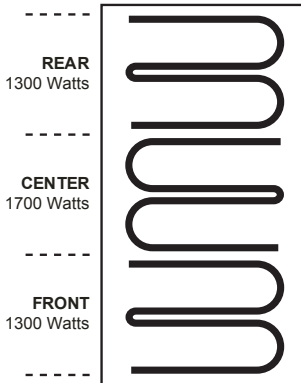

INTERNAL COMPONENTS: MWE3W

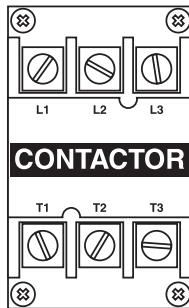
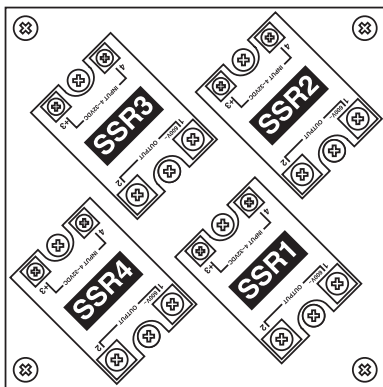

SOLID STATE RELAYS (SSR's)

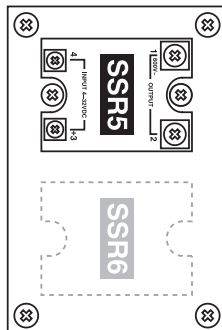

- SSR1 = GRILL SURFACE FRONT
- SSR2 = GRILL SURFACE CENTER
- SSR3 = GRILL SURFACE REAR
- SSR4 = UPPER PLATEN
- SSR5 = UPPER PLATEN
- SSR6 = EXPORT GRILLS ONLY

FRONT OF GRILL

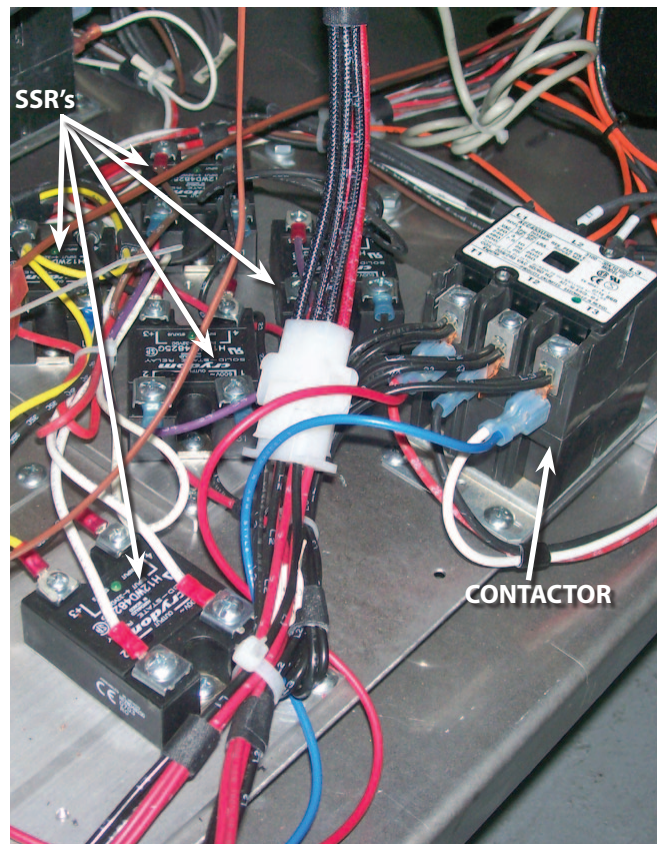

GAS GRILL SUBSYSTEMS (1 of 3 cooking lanes shown)

UPPER PLATEN ELEMENTS: ALL GRILLS

FRONT OF GRILL

3249 WATTS TOTAL (3 ELEMENTS @ 1083 WATTS EA)			
VOLTS	LINE AMPS	ELEMENT AMPS	RESISTANCE
208	9.02	5.20	33.95 Ω
220	8.53	4.92	44.69 Ω
240	7.82	4.51	53.20 Ω

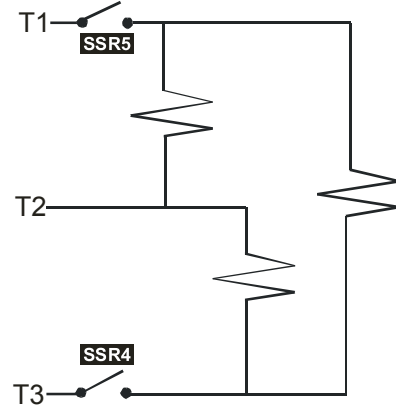
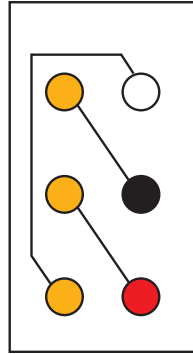

INTERNAL COMPONENTS: MWG3W

SOLID STATE RELAYS (SSR's)

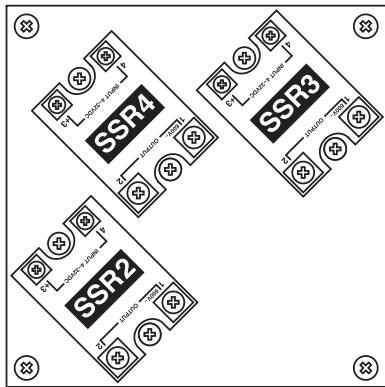

SSR2 = BURNER BLOWER
SSR3 = UPPER PLATEN
SSR4 = UPPER PLATEN

FRONT OF GRILL

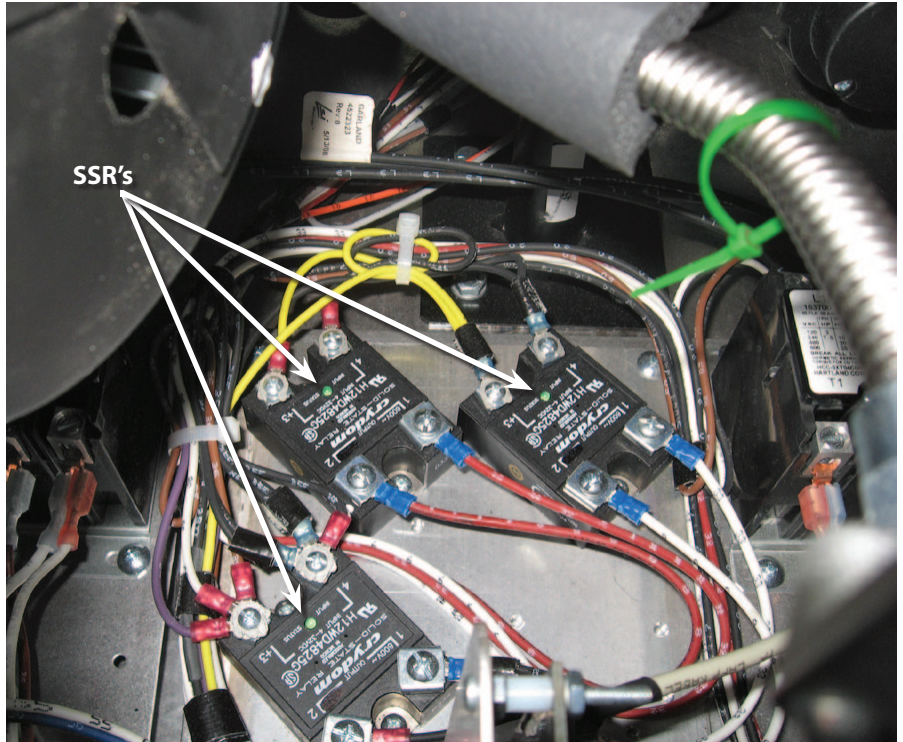

PARTS ID: GRILL EXTERIOR; ALL MODELS

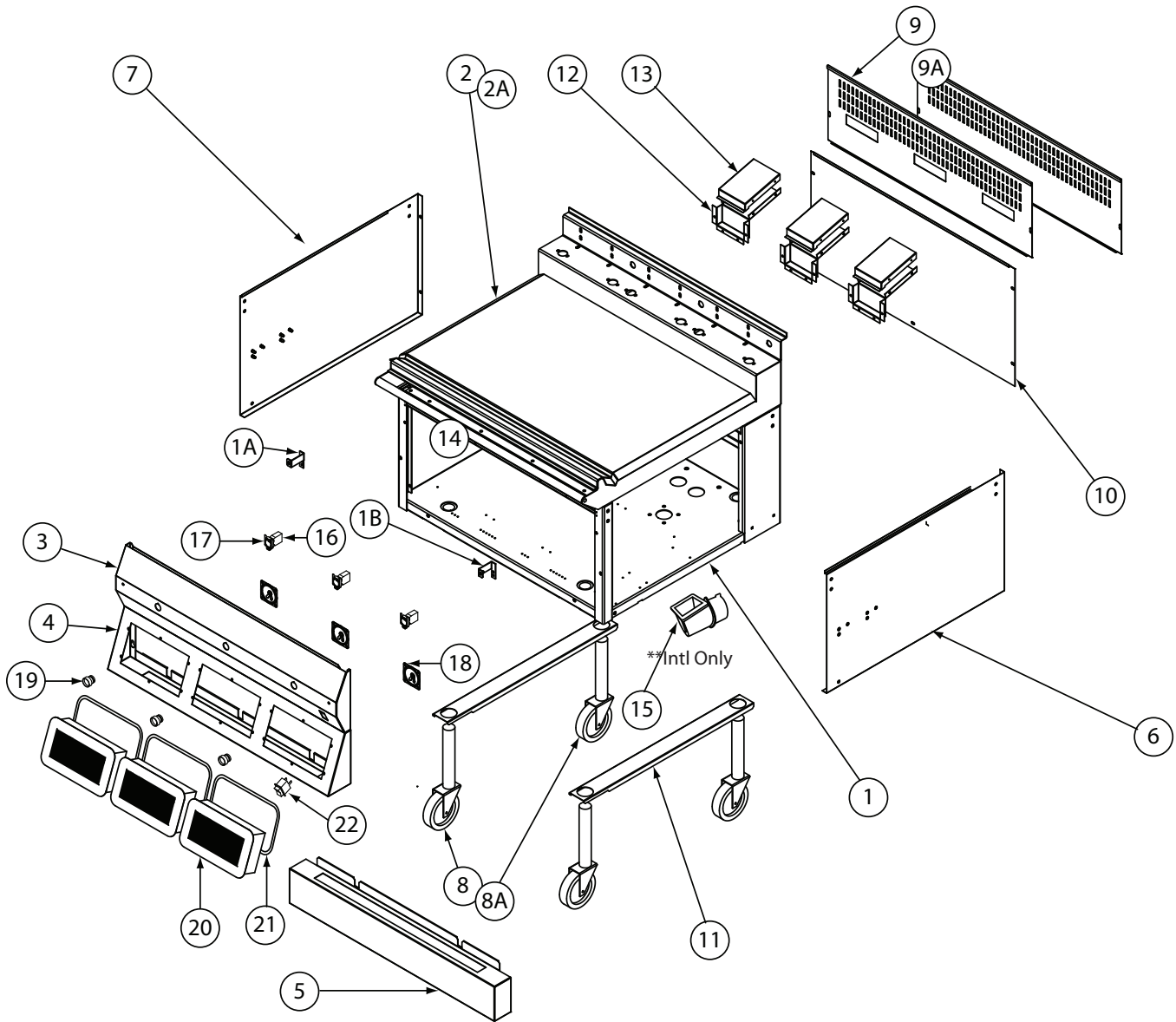

PARTS ID: GRILL EXTERIOR; ALL MODELS

ITEM NO.	PART NUMBER	DESCRIPTION	QTY.
1	4522650	BODY BASE, WA	1
1A	4517928	FRONT PANEL BRACKET, RT	1
1B	4517929	FRONT PANEL BRACKET, LT	1
2	4522707	PLATE WA, GAS	1
2A	4522653	PLATE WA, ELECTRIC	1
3	4522560	FRONT PANEL, UPPER (PRC)	1
4	4520760	FRONT PANEL, MIDDLE (PRC)	1
5	4517747	FRONT PANEL, LOWER	1
6	4522552	BODY SIDE, RT	1
7	4522553	BODY SIDE, LT	1
8	4517563	5" FRONT SWIVEL CASTER W/BRAKE	2
8A	1792003	5" REAR SWIVEL CASTER	2
9	4525272	SPLIT BACK, TOP (GAS)	1
9A	4525273	SPLIT BACK, TOP (ELECTRIC)	1
10	4521436	SPLIT BACK, BOTTOM	1
11	4523352	LEG BRACE LOCKING BRACKET	2
12	4525261	FLUE BOTTOM, GAS	3
13	4525262	FLUE TOP, GAS	3
14	1808302	TOWEL BAR	1
15	1866501	MENNEKES 7-WAY SOCKET	1
16	1859606	CONTACT BLOCK	3
17	1859607	MOUNTING LATCH	3
18	4523482	SPEAKER, 4 WATTS SMT	3
19	1859605	CANCEL PUSH BUTTON, GREEN	3
20	4522735	MAIN CONTROLLER	3
21	1872601	GORE-TEX SEAL, .125"X.020"X2.85'	3
NS	CK4524159	CONTROLLER+SEAL; (1) 4522735 + (1) 18726202	
22	1872404	POWER SWITCH, MAIN 120-240V	1

PARTS ID: GRILL ELEMENT; ELECTRIC MODELS

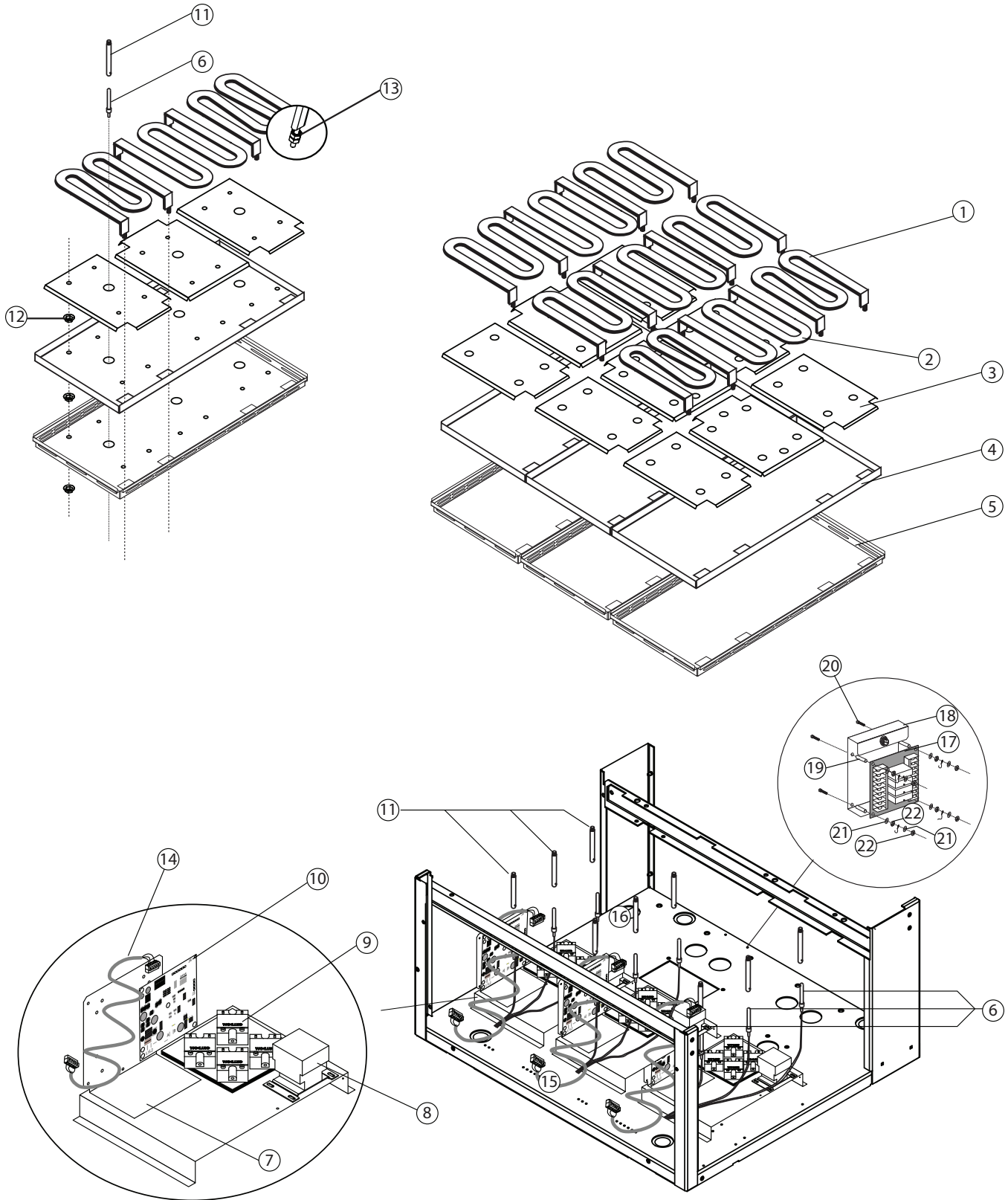

PARTS ID: GRILL ELEMENT; ELECTRIC MODELS

ITEM NO.	PART NUMBER	DESCRIPTION	QUANTITY	
			GRILL	ZONE.
1	4521310	ELEMENT, OUTER, 208V 1300W	6	3
	4521720	ELEMENT, OUTER, 220V 1300W	6	3
	4521312	ELEMENT, OUTER, 230V 1300W	6	3
	4521721	ELEMENT, OUTER, 240V 1300W	6	3
2	4521309	ELEMENT, INNER 208V 1700W	3	1
	4521718	ELEMENT, INNER 220V 1700W	3	1
	4521311	ELEMENT, INNER 230V 1700W	3	1
	4521719	ELEMENT, INNER 240V 1700W	3	1
3	4520682	ELEMENT CLAMP, OUTER	6	3
3A	4520681	ELEMENT CLAMP, INNER	3	1
4	4524029	ELEMENT PAN, UPPER	1	*
5	4524030	ELEMENT PAN, LOWER	1	*
6	4521318	THERMOCOUPLE; GRILL PLATE ELECTIC	9	3
7	4521389	MOTOR SPEED CONTROL BRACKET	3	1
8	1637001	CONTACTOR 120V	3	1
8	1637002	CONTACTOR 240V	3	1
9	4526988	SOLID STATE RELAY	15	5
10	4521682	MOTOR SPEED CONTROL	3	1
11	1859404	BAYONNET ADAPTER	9	3
12	4518173	PAL NUT 5/16-18		
13	4518666	NUT TWIN WHIZ 10-32 LOCK		
14	4521896	COMM CABLE	3	1
15	4522188	TERMINAL BLOCK (CONTROL COMPONENTS)	1	1
16	4517674	TERMINAL BLOCK (3PHASE CONNECTION, ELEC GRILL)	1	1
16A	4525397	TERMINAL BLOCK (3PHASE CONNECTION, GAS GRILL)	1	1
17	4522117	2-SPD FAN RELAY BOARD W SPACERS	1	1
18	4522120	2-SPD FAN RELAY MOUNTING BRACKET	1	1
20		SCREW	4	0
21	8000202	WASHER #8 REG L/W HXFRE MECH	4	0
22	8001209	6-32 FIN HX MACH NUT ZC	4	0

PARTS ID: GRILL BURNER; GAS MODELS

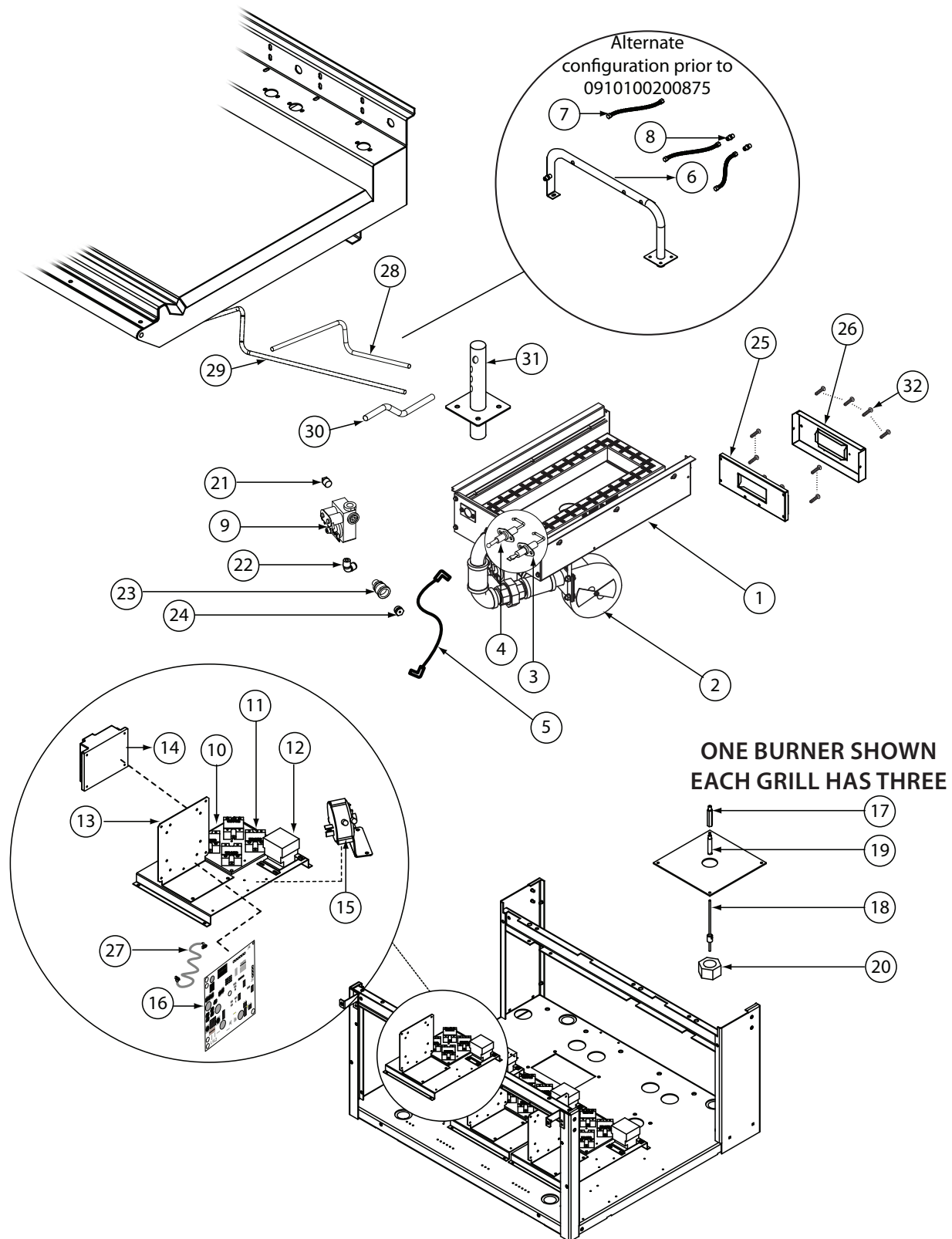

PARTS ID: GRILL BURNER; GAS MODELS

ITEM NO.	PART NUMBER	DESCRIPTION	QUANTITY.	
			GRILL	PLATEN
1	4523394	BURNER ASSY NATURAL	3	1
1	4523395	BURNER ASSY LP	3	1
1	4523396	BURNER ASSY CE NAT	3	1
1	4523397	BURNER ASSY CE LP	3	1
2	4525845	BLOWER MOTOR 120VAC	3	1
2	4526139	BLOWER MOTOR 230VAC	3	1
3	4524066	FLAME SENSOR	3	1
4	4525537	IGNITER	3	1
5	1864803	IGNITION CABLE	3	1
6	4523467	WELDMENT INLET MANIFOLD	1	
7	4527828	FLEXIBLE TUBING 3/8"X10" CORR. SS	3	1
8	4524197	FITTING, STRAIGHT, MALE 3/8" NPT X 5/8"-18, BRASS	3	1
9	1864701	GAS VALVE (NAT/LP) 120VAC	3	1
9	4525846	GAS VALVE CE (NAT/LP) 230VAC	3	1
10	4516116	HEAT SINK	3	1
11	4516988	SOLID STATE RELAY W LED LIGHT	6	2
12	1637001	CONTACTOR 120V COIL	3	1
12	1637002	CONTACTOR 240V COIL	3	1
13	4521389	MOTOR SPEED CONTROL BRACKET	3	1
14	1864901	IGNITION MODULE 120V	3	1
14	4522571	IGNITION MODULE PACTROL 230V CE	3	1
15	4517392	AIR PRESSURE SWITCH	3	1
16	4521682	MOTOR SPEED CONTROL	3	1
17	3084200	BAYONET ADAPTOR EXTENSION	3	1
18	4521710	THERMOCOUPLE, GRILL PLATE (GAS GRILLS)	3	1
19	1859404	BAYONET ADAPTOR (GRILL PLATE)	3	1
20	1853301	LEG NUT, 1-1/2 X 12	3	1
21	NO P/N	PLUG 1/4" NPT	3	1
22	4524198	FITTING, 90DEG, ELBOW - 3/8" NPT X 5/18"-18, BRASS	3	1
23	NO P/N	ORIFICE MOUNTING TUBE	3	1
24	NO P/N	ORIFICE	3	1
25	4517396	FLUE BOX, INNER	3	1
26	4517397	FLUE BOX, OUTER	3	1
27	4521896	COMM CABLE	3	1
28	4521678	GAS TUBE CTR	1	1
29	4521679	GAS TUBE LT	1	1
30	4521677	GAS TUBE RT	1	1
31	4517394	GAS INLET MANIFOLD	1	*
32	8002106	SMSCR-TH PHIL-A #10 X1/2 STL SP		

PARTS ID: UPPER PLATEN ASSEMBLY; ALL MODELS

Shoulder Bolt Assy Magnet Assy

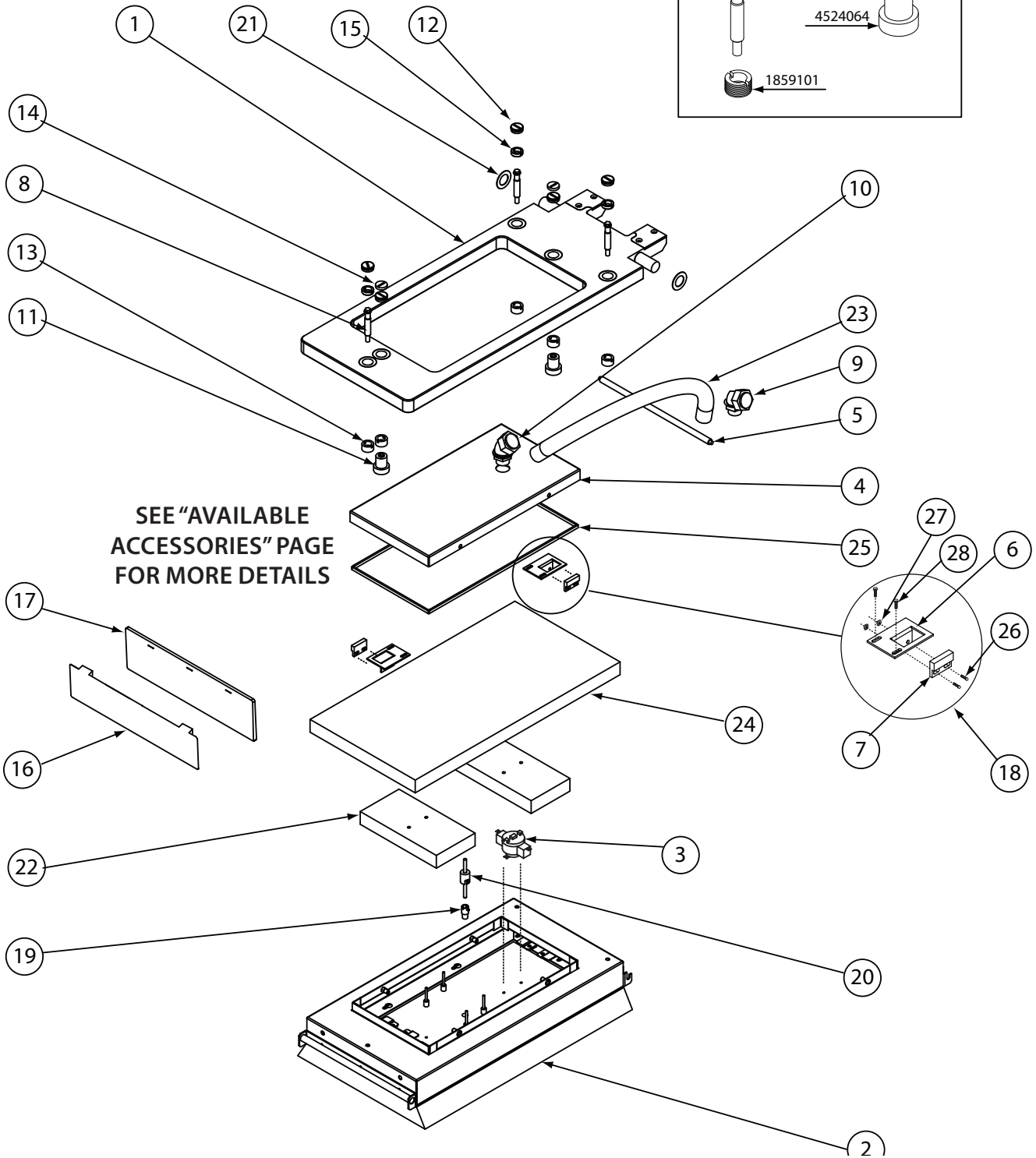
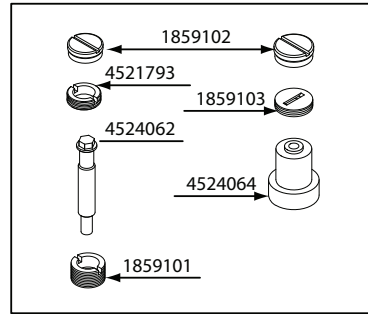

SEE "AVAILABLE ACCESSORIES" PAGE FOR MORE DETAILS

PARTS ID: UPPER PLATEN ASSEMBLY; ALL MODELS

ITEM NO.	PART NUMBER	DESCRIPTION	QUANTITY.	
			GRILL	PLATEN
1	4521293	PLATEN ARM ASSEMBLY	3	1
2	CK4525497	PLATEN ASSEMBLY; 208V	3	1
	CK4525498	PLATEN ASSEMBLY; 220V	3	1
	CK4525499	PLATEN ASSEMBLY; 230V	3	1
	CK4525500	PLATEN ASSEMBLY; 240V	3	1
3	1781301	HIGH LIMIT (AUTO RESET)	3	1
3	1866601	HIGH LIMIT (MANUAL RESET) *EXPORT ONLY	3	1
4	4520806	PLATEN LID	3	1
5	4521355	TEFLON BAR, REAR	3	1
6	4521698	SENSOR MOUNT, REED SWITCH BRACKET	6	2
7	4521314	SENSOR, PRODUCT RECOGNITION, REED SWITCH	6	2
8	4524062	SHOULDER BOLT, PLATEN	6	3
9	4521709	1/2IN X 90 DEG LIQUID TIGHT FITTING	3	1
10	1854504	1/2IN X 45 DEG. LIQUID TIGHT FITTING	3	1
11	4524064	MAGNET ASSY	6	2
12	1859102	PLATEN ADJUSTER CAP	15	5
13	1859101	PLATEN ADJUSTER NUT	15	5
14	1859103	PLATEN ADJUSTER LOCK NUT	6	2
15	4521793	LOCK NUT	9	3
16	4525214	PLATE, VAPOR SHIELD	3	1
17	4523425	SILICONE, VAPOR SHIELD	3	1
18	4524070	REED SWITCH ASSEMBLY	6	2
19	1859402	PLATEN BAYONET ADAPTOR	3	1
20	4521711	THERMOCOUPLE	3	1
21	1855903	TEFLON WASHER CARRIAGE SHAFT	6	2
22	4522054	PLATEN WEIGHT	6	2
23	1854403	ATX-11 CONDUIT BLACK	3	1
24	0010000FG	1IN FIBERGLASS INSULATION #SGR-6	3	1
25	000500GIS	.500 GORE-TEX SEAL STRIP	3	1
26	4526536	HH MS 4-40X1/2" 18-8 SS		
27	8001506	NUT W/L WASHER 4-40 SS		
28	4522260	ALLEN HEAD MOUNTING SCREW - 6-32 X 3/8"		

PARTS ID: PLATEN LIFTING MECHANISM; ALL MODELS

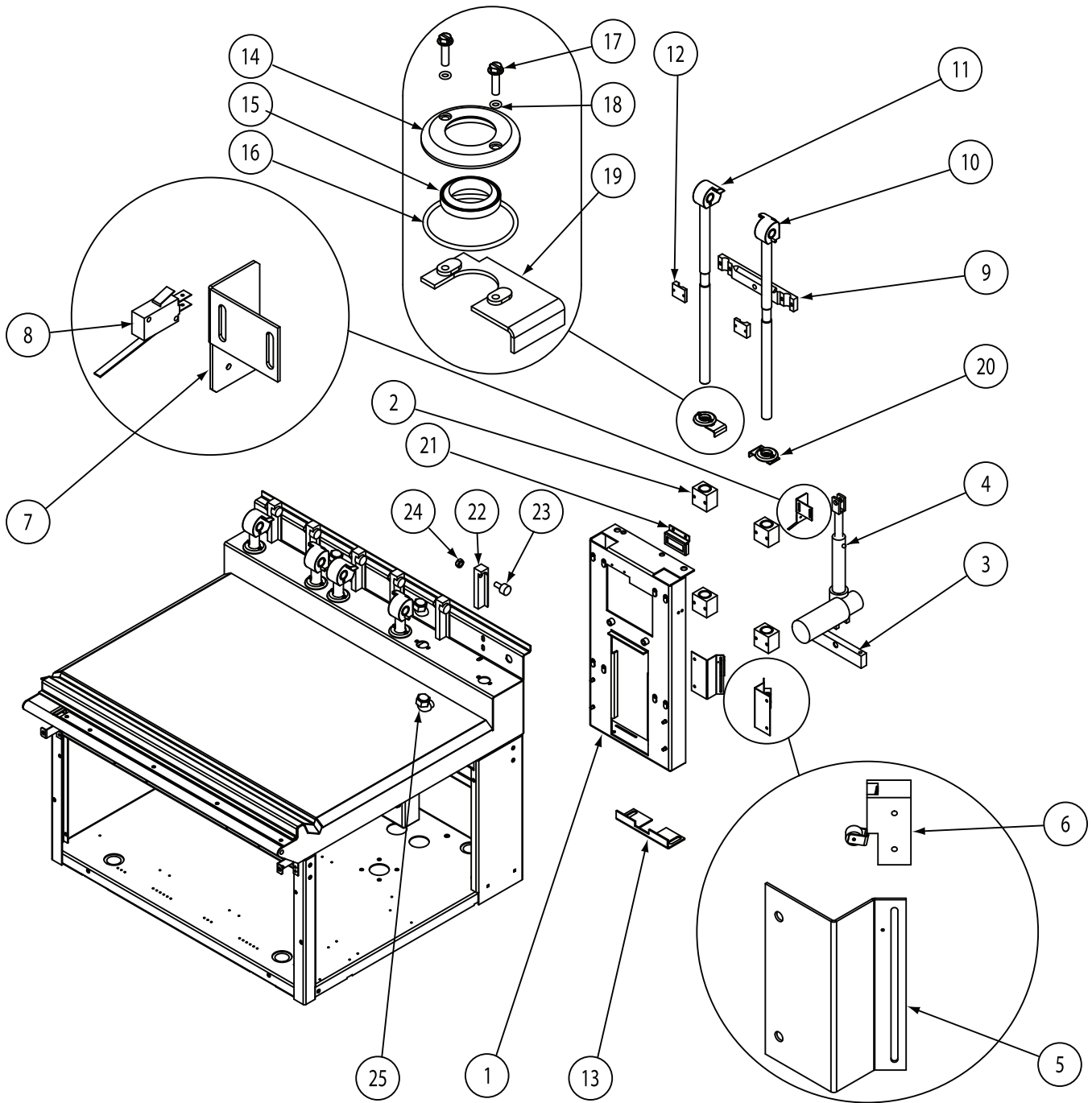

PARTS ID: PLATEN LIFTING MECHANISM; ALL MODELS

ITEM NO.	PART NUMBER	DESCRIPTION	QTY.
1	4523868	ACTUATOR FRAME, PAINTED	3
2	1858199	PILOW BLOCK ASSEMBLY	12
3	1858001	ACTUATOR CLEVIS MOUNT	3
4	4525541	LINEAR ACTUATOR	3
5	1857601	LIMIT SWITCH BRACKET	6
6	1855601	STOP LIMIT SWITCH,	6
7	4521654	SWITCH BRACKET, RUNAWAY	3
8	1855604	LIMIT SWITCH (KILL)	3
9	4522318	CROSS MEMBER, PAINTED	3
10	4523364	ARM CARRIAGE, SHAFT ASSEMBLY (RT)	3
11	4522540	ARM CARRIAGE, SHAFT ASSEMBLY (LT)	3
12	4518788	ACTUATOR CROSS MEMBER CLAMP, PAINTED	6
13	4523856	ACTUATOR FRAME BRACE, PAINTED	3
14	1857703	SEAL CAP	6
15	4526311	SHAFT SEAL WIPER, BLACK SOLID	6
15	4526312	SHAFT SEAL WIPER, BLACK W/ BLUE DOT SPLIT	-
16	1874201	SEAL CAP O-RING	6
17	8003437	SCREW, HXSLT #8-32 X 1	12
18	1874301	#8-32 O-RING	12
19	1863396	SEAL CAP MOUNTING BRKT, S/W LT (PAINTED)	3
20	1863397	SEAL CAP MOUNTING BRKT, S/W RT (PAINTED)	3
21	4522600	HI-LIMIT BRACKET, JAPAN	3
22	4521294	ARM PIVOT BLOCK	6
23	1854902	CAM FOLLOWER W/SHAFT	6
24	1854903	JAM NUT	6
25	4521709	1/2IN CONNECTOR, 90DEG.	3

PARTS ID: WIRING HARNESSES; ALL MODELS

1859803 -
Main Power
Switch
Harness
(Molex Plug
to Terminal
Block)

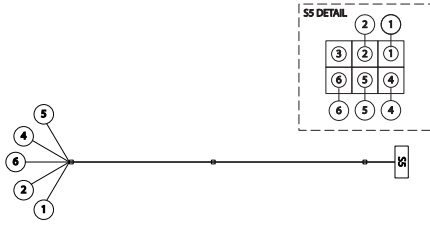

1859833 -
Main Power
Switch
Harness -
Molex Plug to
Switch

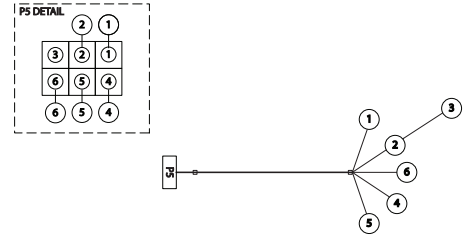

1859807 -
Upper Platen
Harness
(Molex Plug
to upper
platen)

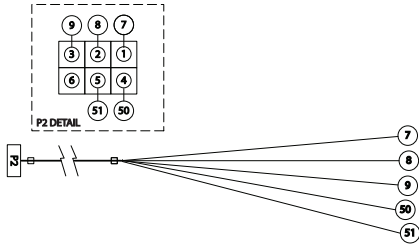

4521950 -
Pushbutton
Harness

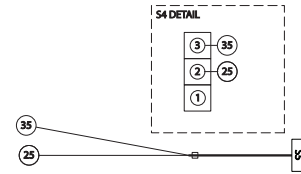

1859814 -
Upper Platen
Harness
(Molex Plug
to upper
platen)

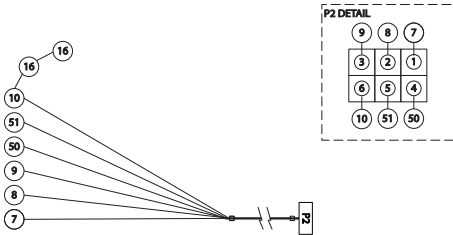

4522630 -
Relay Harness
- Grill Plate
Heater Molex
to SSR's /
Contactor

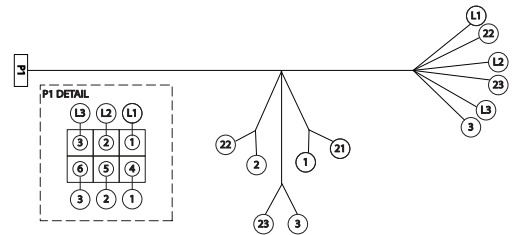

1859808 -
Main Heater
Harness
(Electric
Grills) - Molex
to Grill Plate
Heating
elements

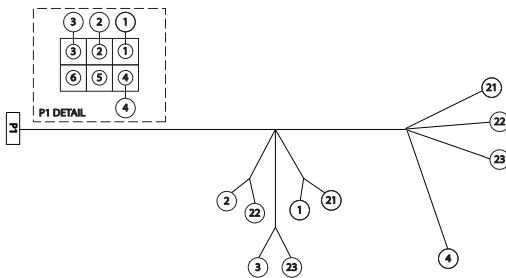

4521767 -
Reed Switch
Harness

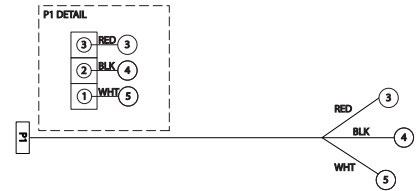

1859813 -
Main Heater
Harness
(Electric
Grills) - Molex
to Grill Plate
Heating
elements

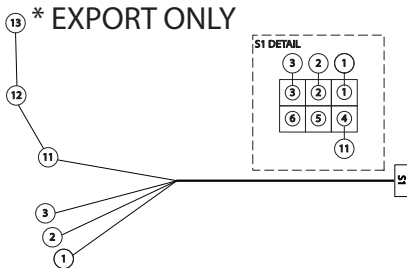

4522078 -
2-Spd Fan
Harness

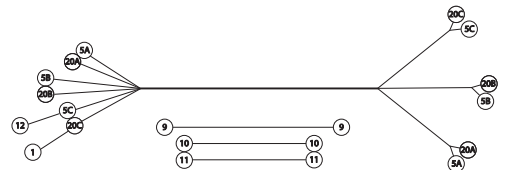

PARTS ID: WIRING HARNESSES; ALL MODELS

4521770

- Terminal
Block Harness
- Terminal
Block to
Molex

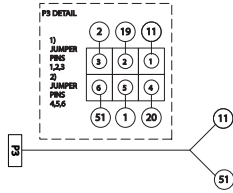

4521811

- Mennekes
Harness -
Mennekes
socket to
contactor
/ terminal
block

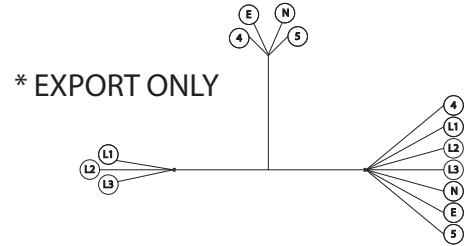

4522642

- Relay Harness
- Grill Plate
Heater Molex
to SSR's /
Contactor

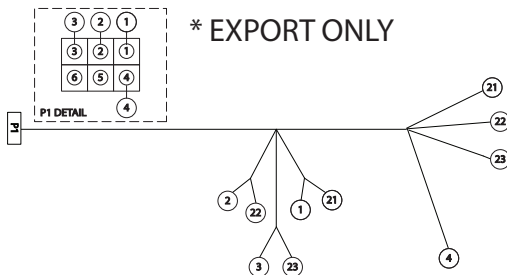

4523304

- Grill Plate
High Limit
Harness

* JAPAN ONLY



4521951

- Contactor
Jumper
Harness -
Contactor to
Contactor

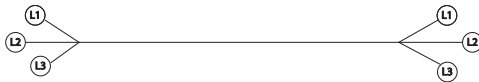

4521898

- Ignition
Harness
- Ignition
Module to
Gas Valve
Molex

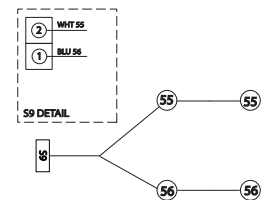

4522324

- Terminal
Block Harness
- Mennekes
socket to
terminal
block



See grill wiring diagram
4522634 - This harness
used if 1~220

PARTS ID: WIRING HARNESSES; ALL MODELS

4522628 -
Main Harness

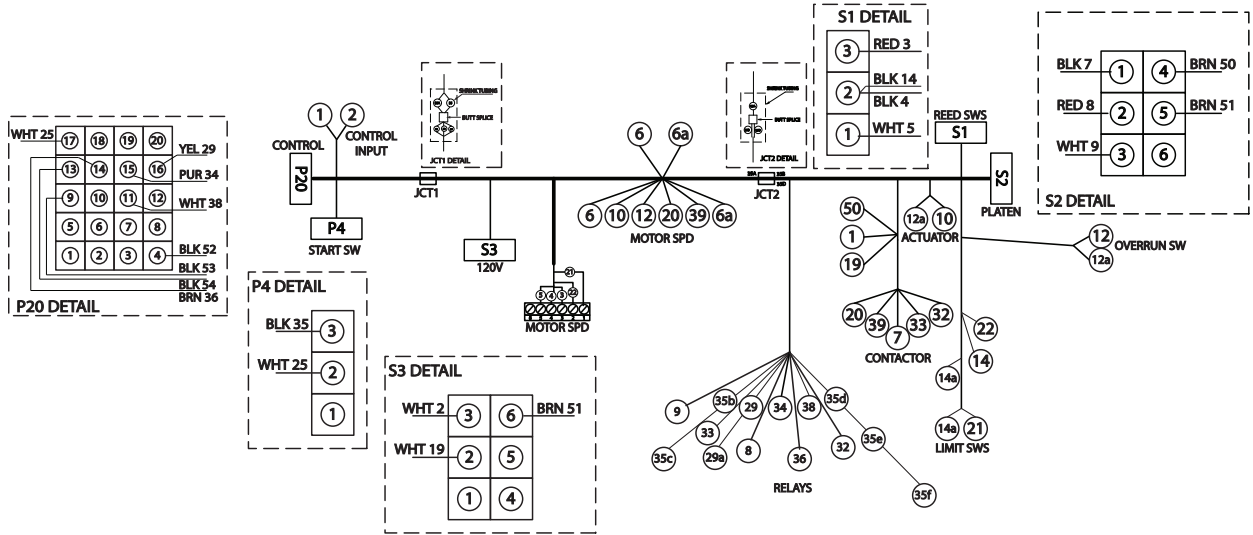

4522629 -
Main Harness
- EXPORT
MODELS * EXPORT ONLY

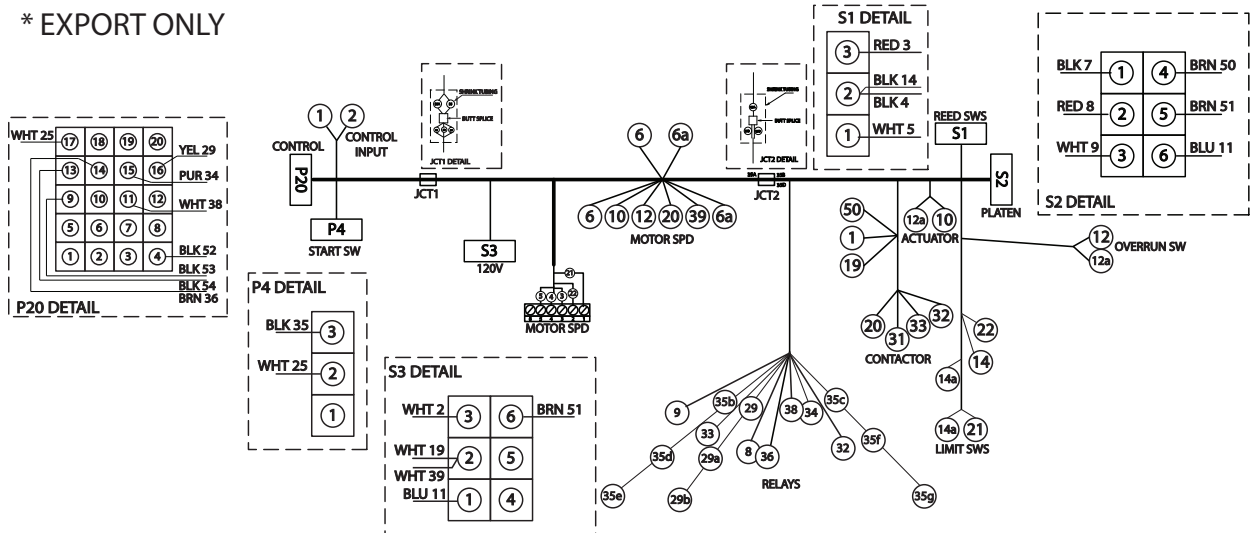

120V CONTROL CIRCUIT; MWE3W

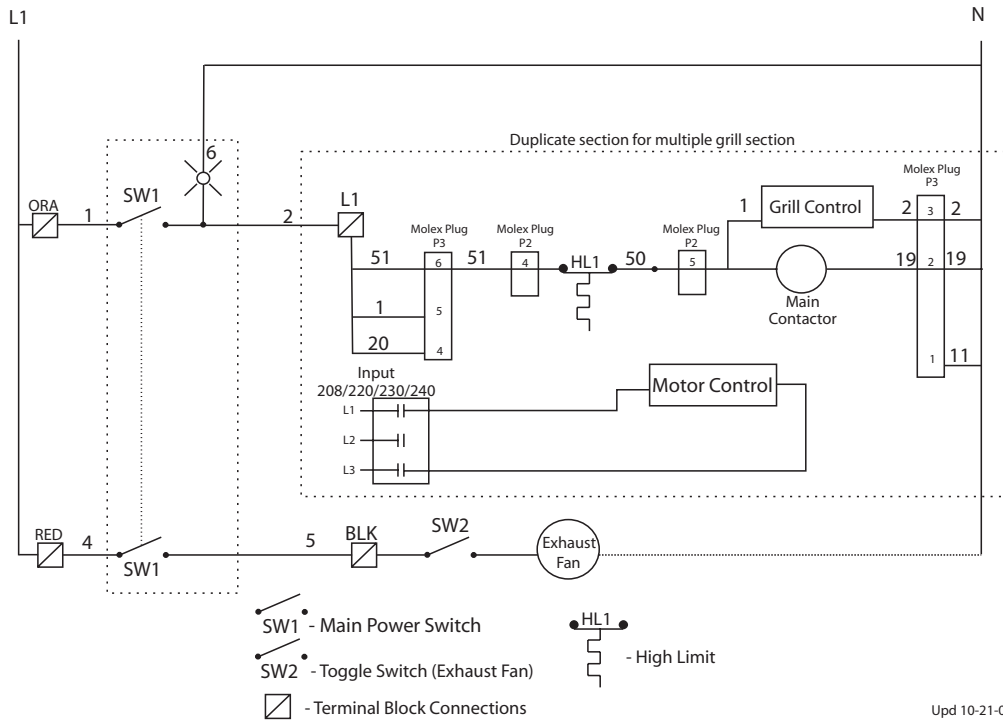

120V CONTROL CIRCUIT; MWG3W

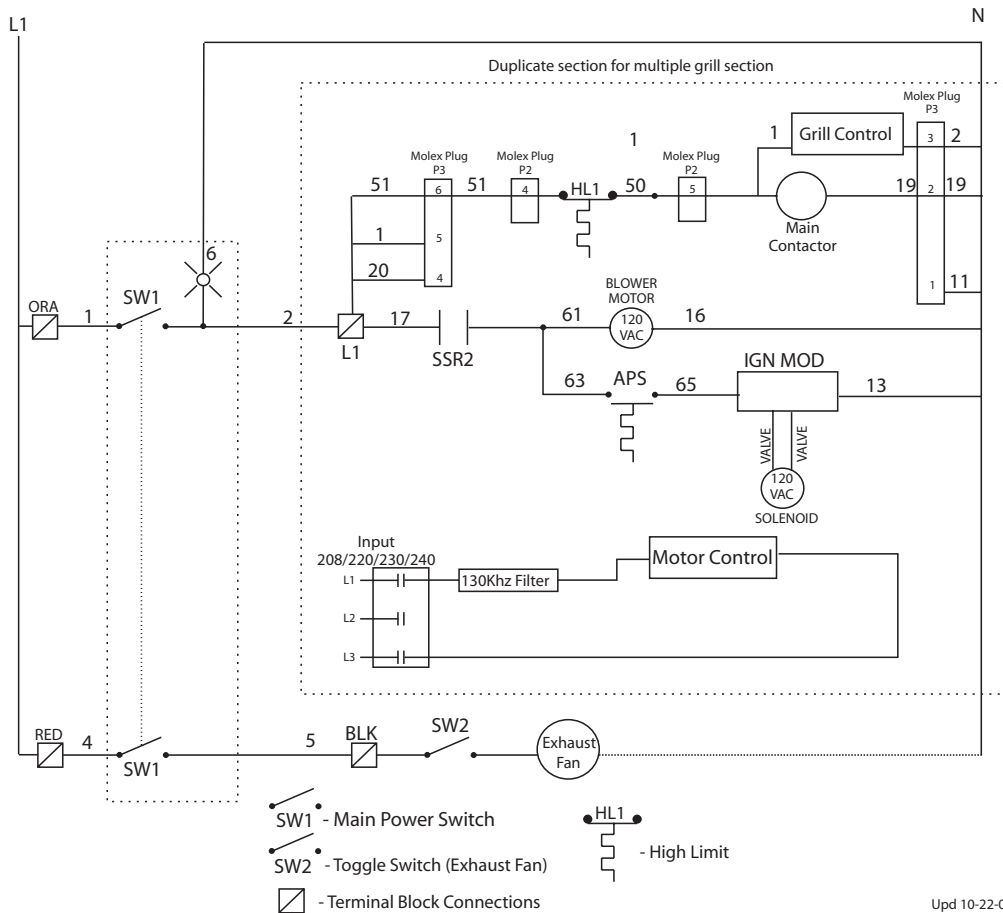

INDEX

- A**
- Accessories 20, 58
 - Quick-Disconnect 20
 - Splash Shield 20, 58
 - Teflon Sheet 20. *See also* Release Material Sheets
 - Vapor Shield 20, 59
 - Auto Calibration 24, 42, 43
 - AUTO GAP FORCE mode 21, 24, 40
 - Auto mode 23
 - Breakfast In Auto mode 23
- B**
- Beef Integrity 12, 27
 - Patty placement 26
 - breakfast 23, 24
- C**
- Calibration
 - Platen 39
 - AUTO GAP FORCE mode 21, 24, 40
 - Forced Auto Calibration 24, 40
 - LEVEL/REED SW mode 39, 40
 - Probe Calibration 21, 38
 - Temperature. *See* Calibration: Probe Calibration
 - CHECK REED SWITCH 21, 36
 - Cooking
 - Auto mode 23
 - Breakfast In Auto mode 23
 - Breakfast 23, 24
 - cook time 21, 23, 30
 - Lunch 23, 24. *See also* Cooking: Auto mode
 - Manual mode 23
 - Breakfast In Manual mode 23
 - manual cooking 21
 - Multi Stage Cooking 22
 - Product Recognition 21, 22, 24. *See also* Cooking: Auto mode
 - Standard Cooking 22
 - Standby Mode 21, 23, 28, 31, 39, 40
 - To Select a Menu item 22
 - Transition 24
 - cook time 21, 23, 30
 - cords
 - Electrical 12, 13, 40
- E**
- Electrical cords. *See* cords: Electrical
 - Error Messages
 - CHECK REED SWITCH 21, 36
 - GRILL PROBE ERROR 21, 36
 - MOTOR PINCH ERR 37
 - MOTOR SPD ERR 37
 - exhaust hood 12, 15, 36. *See also* Installation
- F**
- Factory Defaults 31, 35
 - Flue box 12, 15, 57
 - Forced Auto Calibration 24, 25, 40
- G**
- Gap Calibration. *See* Calibration: Platen
 - Gas hose 12, 14
 - Gas pressure 12, 36. *See also* Installation: Grill
- I**
- Indicator Lights 23
 - Installation. *See also* Specifications
 - flue box 12, 15
 - Grill 12
 - startup 12, 16
- L**
- LED light 23, 36, 41
 - Leveling Platen. *See* Calibration: Platen
 - LEVEL/REED SW mode 39, 40
 - Lunch 23, 24
- M**
- Magnet Assembly 39, 40, 43, 44, 59
 - Manual mode 23
 - Breakfast In Manual mode 23
 - MOTOR PINCH ERR 37
 - MOTOR SPD ERR 37
- P**
- Parts Identification 52, 53, 54, 55, 56, 57, 58, 59, 60, 61, 62, 63, 64
 - Patty placement 26
 - Platen height 15
 - Power Cords. *See* cords: Electrical
 - Probe Calibration. *See* Calibration: Probe Calibration
 - Programming 21, 22, 27, 28, 29, 31
 - AUTO GAP FORCE mode 21, 24, 40
 - Factory Defaults 31, 35
 - LEVEL/REED SW mode 39, 40
 - PROBE CAL mode 38
- Q**
- Quick-Disconnect 14, 20. *See also* Gas hose
- R**
- reed switch 36, 40, 41, 43, 44
 - Reed Switch, LED operation 41, 42, 43
 - Reed Switch, setting 40
 - Release Material Sheets
 - release material 12, 19, 38
- S**
- Specifications 8, 9, 10, 11, 13
 - Splash Shield 18, 20
 - Standby mode 21, 23, 28, 31, 39, 40
 - startup 12, 16
- T**

INDEX (continued)

Teflon Sheet 20. *See also* Release Material Sheets

Temperature

set point 12, 21, 22, 23, 24, 27, 28, 29, 30, 31, 38

Temperature Calibration. *See* Calibration: Probe Calibration

Thermocouple(s) 38, 57, 59. *See also* Calibration: Probe Calibration

V

Vapor Shield 20, 59

Z

Zeroing Platen. *See* Calibration: Platen

Garland Service Manual



Gas & Electric Clamshell Grills With Product Recognition

Garland Commercial Industries, LLC, 185 East South Street, Freeland, Pennsylvania 18224
Phone: +1 (570) 636-1000 • Fax: +1 (570) 636-9874
TOLL FREE Service Hotline: (800) 446-8367
<http://www.garland-group.com> • Email: qsrservice@garland-group.com



PART #4526396 (03/30/10)