

Parts Catalog



GHPSU636G

Step Up Hot Plate Gas Cooking Equipment

Model: GHPSU636G

8/15/2023 Rev A

IMPORTANT!

TO EXPEDITE SHIPMENT OF PARTS, ALWAYS SPECIFY MODEL, REV,
PART NUMBER, AND SERIAL NUMBER OF UNIT.

GLOBE FOOD EQUIPMENT COMPANY

2215 East River Road
Dayton, Ohio 45439

Parts Department

Toll Free 1-800-745-6238 · Fax (937) 290-0585

E-Mail: info@globefoodequip.com

Website: www.globefoodequip.com

Not for resale

Table of Contents

Description

Page

GHPSU636G Step Up Hot Plate Components

4

GHPSU636G Gas Orifice Elevation Chart

6



GHPSU636G Step Up Hot Plate Components

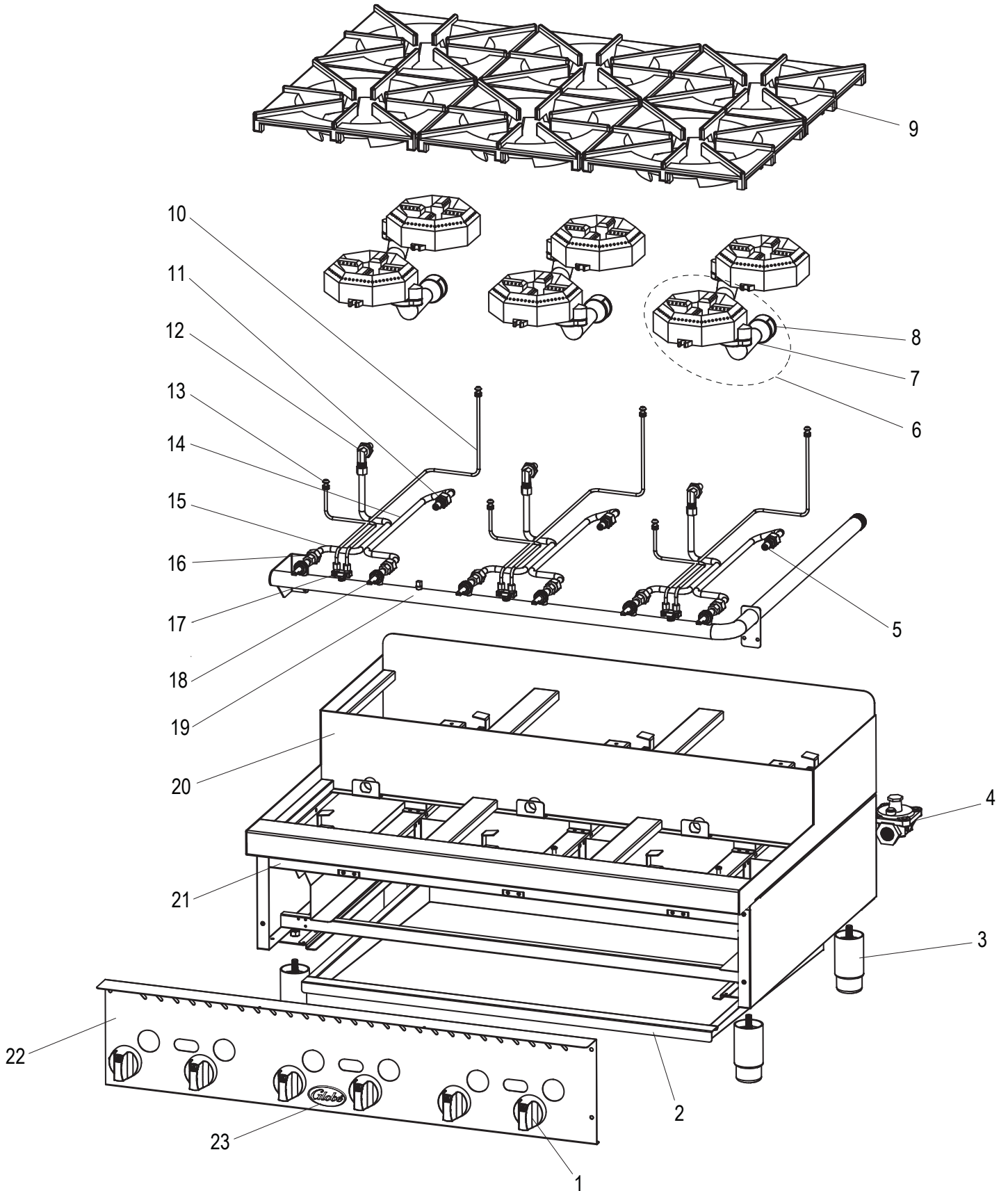



GHPSU636G Step Up Hot Plate Components

Item	Part Number	Description	Qty	Serial Number
1	U01021005188	Control Knob	6	
2	U00815	Drip Tray	1	
3	U01021005165	Foot	4	
4	U01221069501	Regulator	1	
5	U06051470839	Hood Orifice #43	6	
5	U06051470824	Hood Orifice #52	6	
5	U06051470869	Hood Orifice #44	6	
5	U01201068653	Hood Orifice #53	6	
5	U06051470899	Hood Orifice #45	6	
5	U06051470695	Hood Orifice (2 Pack) #46	6	
5	U01201068654	Hood Orifice #54	6	
5	U06051470881	Hood Orifice (2 Pack) #48	6	
6	U02038	Burner Assembly	6	
7		Burner	1	
8		Air Shutter	1	
9	U01072	Trivet	6	
10	U02031	Back Pipe, Pilot Assembly	3	
11	U02032	Front Main Injector	3	
12	U02033	Rear Main Injector	3	
13	U02034	Front Pipe, Pilot Assembly	3	
14	U02035	Front Main Gas Pipe	3	
15	U02036	Rear Main Gas Pipe	3	
16	U02037	Connection Valve	6	
17	U01201068502	Manual Control Valve (A18)	6	
18	U01201068508	Pilot Valve	3	
19		Manifold Assembly	1	
20		Main Enclosure	1	
21		Isolating Plate, Front	1	
22		Control Panel	1	
23	U01021005383	Globe Badge	1	
24	U01021005186	Ignition Bar	(Not Shown)	1
25	U04031317503	Control Knob Overlay	(Not Shown)	1



GHPSU636G Gas Orifice Elevation Chart

Model	Rated Input Per Burner (BTU/HR)	Elevation		Elevation	
		0-2000 ft		2000 - 4000 ft	
		Nat	LP	Nat	LP
Step Up Hot Plate	30000	U06051470839 (# 43)	U06051470824 (#52)	U06051470869 (#44)	U01201068653 (#53)
		Elevation		Elevation	
		4000 - 6000 ft		6000 - 8000 ft	
		Nat	LP	Nat	LP
Step Up Hot Plate	30000	U06051470899 (#45)	U01201068653 (#53)	U06051470695 (#46)	U01201068654 (#54)
		Elevation			
		8000 - 10000 ft			
		Nat	LP		
Step Up Hot Plate	30000	U06051470881 (#48)	U01201068654 (#54)		