

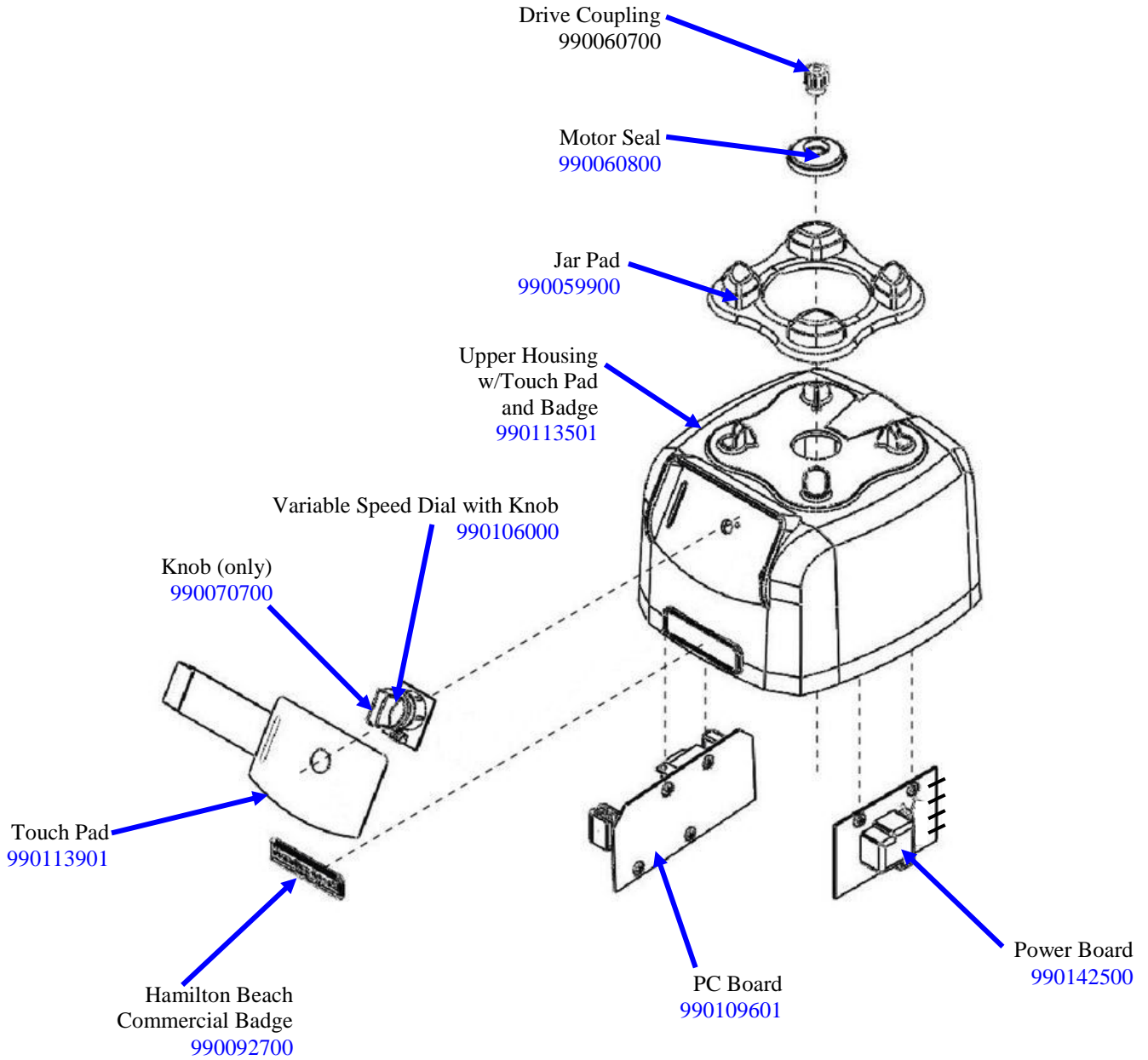

## Replacement Parts Diagrams

### HBF600

**PROPRIETARY RIGHTS NOTICE** This document and all information contained within it is the property of Hamilton Beach Brands, Inc. (HBB). It is confidential and proprietary and has been provided to you for a limited purpose. It must be returned or destroyed upon request. Disclosure, reproduction or use of this document and any information contained within it, in full or in part, for any purpose is forbidden without the prior written consent of HBB. No photographs may be taken of any article fabricated or assembled from this document without the prior written consent of HBB.



 4421 Waterfront Drive Glen Allen, VA 23060	Revision Description: Add Food Bands							
	Request Number:	DOC9613	Revision Date:	12/27/2018	Approved by:	DOC9613		
	Issue Code(s):	CS, SP	Page:	1 of 5	Document #:	540003400	Rev:	F

## Replacement Parts Diagrams

### HBF600

**PROPRIETARY RIGHTS NOTICE** This document and all information contained within it is the property of Hamilton Beach Brands, Inc. (HBB). It is confidential and proprietary and has been provided to you for a limited purpose. It must be returned or destroyed upon request. Disclosure, reproduction or use of this document and any information contained within it, in full or in part, for any purpose is forbidden without the prior written consent of HBB. No photographs may be taken of any article fabricated or assembled from this document without the prior written consent of HBB.

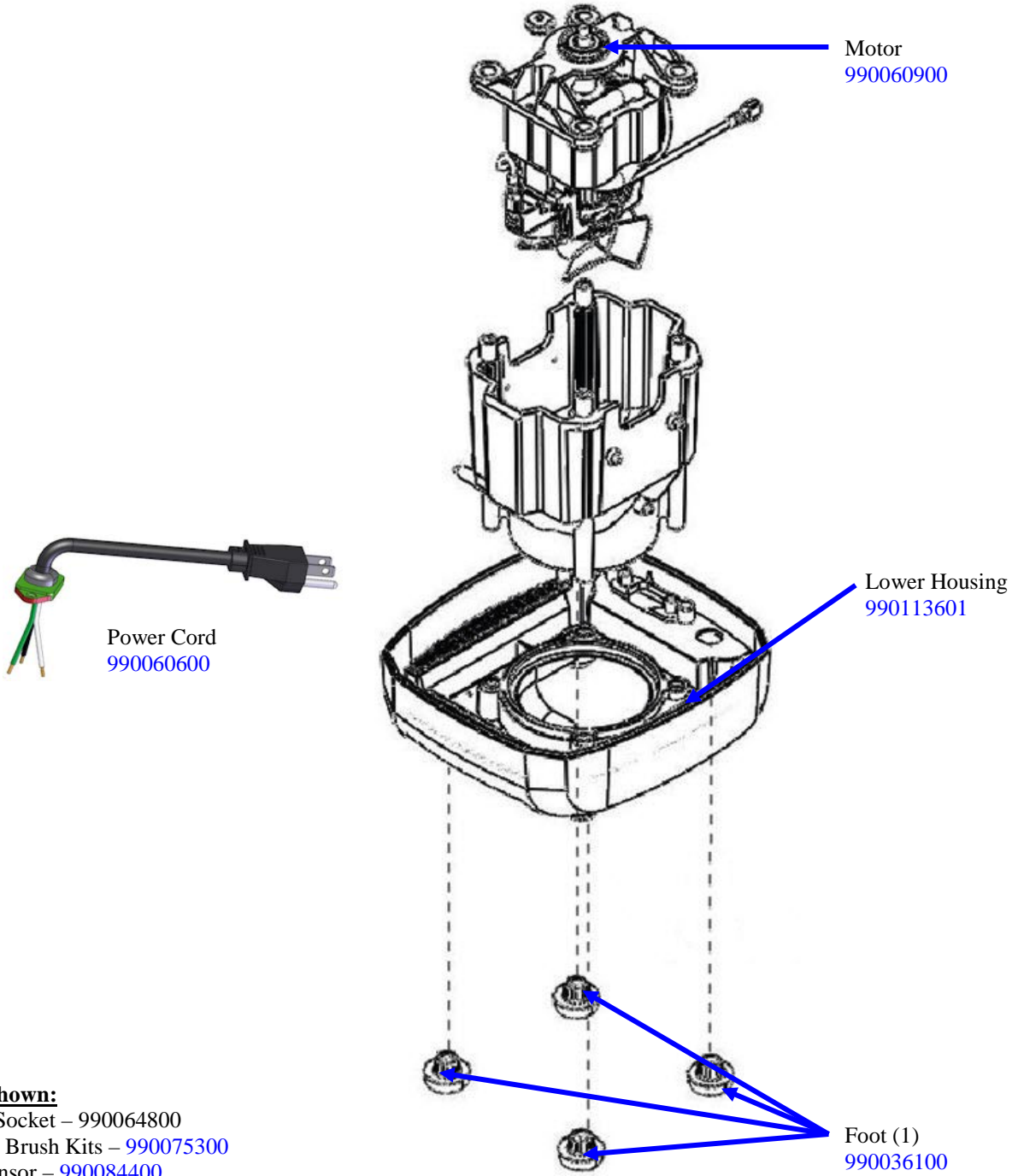

**Not Shown:**

- Cord Socket – 990064800
- Motor Brush Kits – 990075300
- Jar Sensor – 990084400
- Breaker Switch – 990114100

 <p><b>Hamilton Beach</b> 4421 Waterfront Drive Glen Allen, VA 23060</p>	Revision Description: Add Food Bands		Request Number: DOC9613		Revision Date: 12/27/2018		Approved by: DOC9613	
	Issue Code(s): CS, SP		Page: 2 of 5		Document #: 540003400		Rev: F	

## Replacement Parts Diagrams

### HBF600

**PROPRIETARY RIGHTS NOTICE** This document and all information contained within it is the property of Hamilton Beach Brands, Inc. (HBB). It is confidential and proprietary and has been provided to you for a limited purpose. It must be returned or destroyed upon request. Disclosure, reproduction or use of this document and any information contained within it, in full or in part, for any purpose is forbidden without the prior written consent of HBB. No photographs may be taken of any article fabricated or assembled from this document without the prior written consent of HBB.

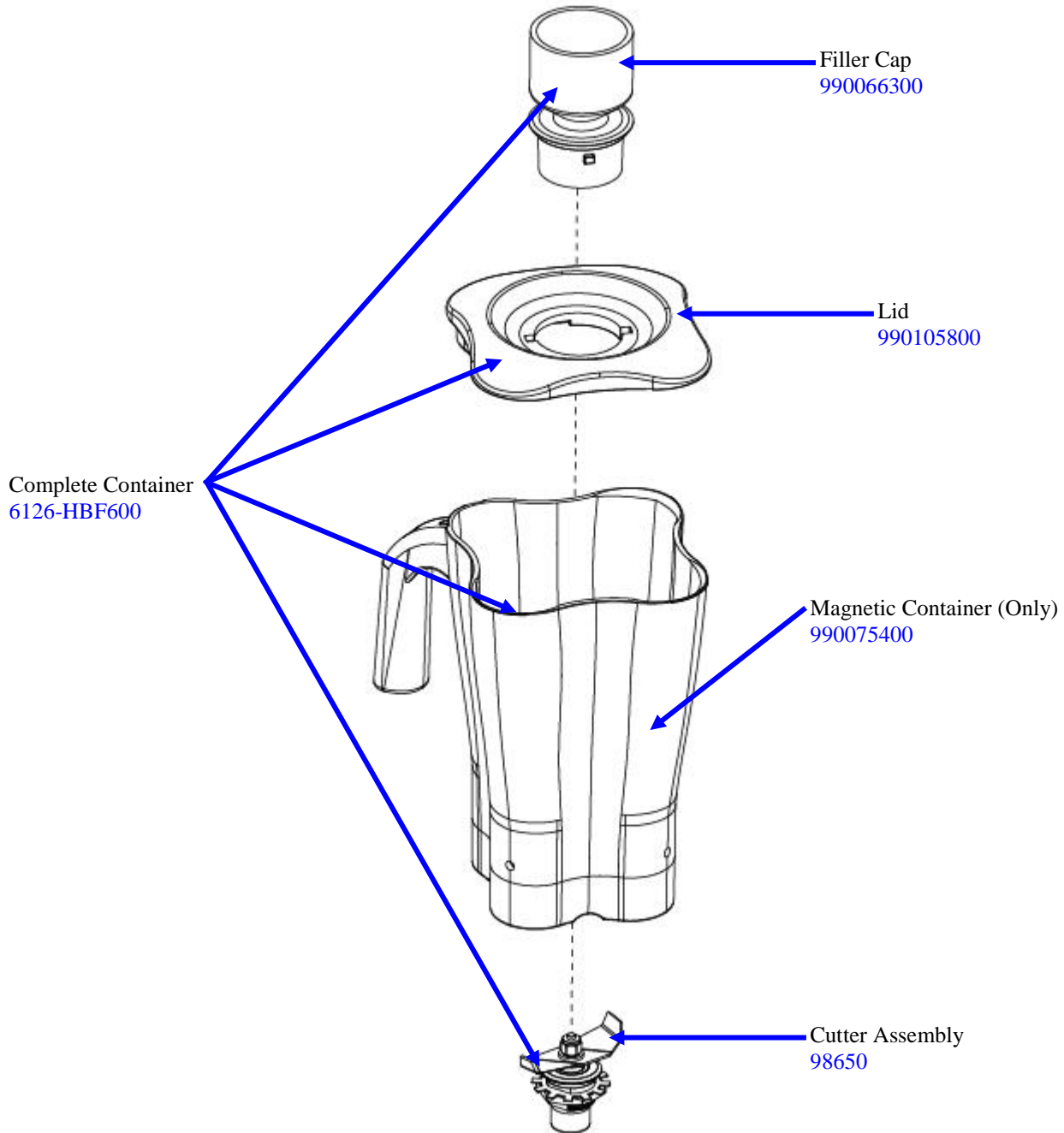

 Hamilton Beach 4421 Waterfront Drive Glen Allen, VA 23060	Revision Description:		Add Food Bands				
	Request Number:	DOC9613	Revision Date:	12/27/2018	Approved by:	DOC9613	
	Issue Code(s):	CS, SP	Page:	3 of 5	Document #:	<b>540003400</b>	Rev:

## Replacement Parts Diagrams

### HBF600

**PROPRIETARY RIGHTS NOTICE** This document and all information contained within it is the property of Hamilton Beach Brands, Inc. (HBB). It is confidential and proprietary and has been provided to you for a limited purpose. It must be returned or destroyed upon request. Disclosure, reproduction or use of this document and any information contained within it, in full or in part, for any purpose is forbidden without the prior written consent of HBB. No photographs may be taken of any article fabricated or assembled from this document without the prior written consent of HBB.

### Band Complete Set – 990123600 (includes all bands below).



**Food Band, Purple (Allergy)**  
P/N - 990123100

**Food Band, White (Cheese)**  
P/N - 990123200



**Food Band, Red (Meat)**  
P/N - 990123400



**Food Band, Brown (Seafood)**  
P/N - 990123300



**Food Band, Green (Vegetables)**  
P/N - 990123500



 4421 Waterfront Drive Glen Allen, VA 23060	Revision Description:		Add Food Bands				
	Request Number:	DOC9613	Revision Date:	12/27/2018	Approved by:	DOC9613	
	Issue Code(s):	CS, SP	Page:	4 of 5	Document #:	540003400	Rev:

## Replacement Parts Diagrams

### HBF600

**PROPRIETARY RIGHTS NOTICE** This document and all information contained within it is the property of Hamilton Beach Brands, Inc. (HBB). It is confidential and proprietary and has been provided to you for a limited purpose. It must be returned or destroyed upon request. Disclosure, reproduction or use of this document and any information contained within it, in full or in part, for any purpose is forbidden without the prior written consent of HBB. No photographs may be taken of any article fabricated or assembled from this document without the prior written consent of HBB.

### Accessories

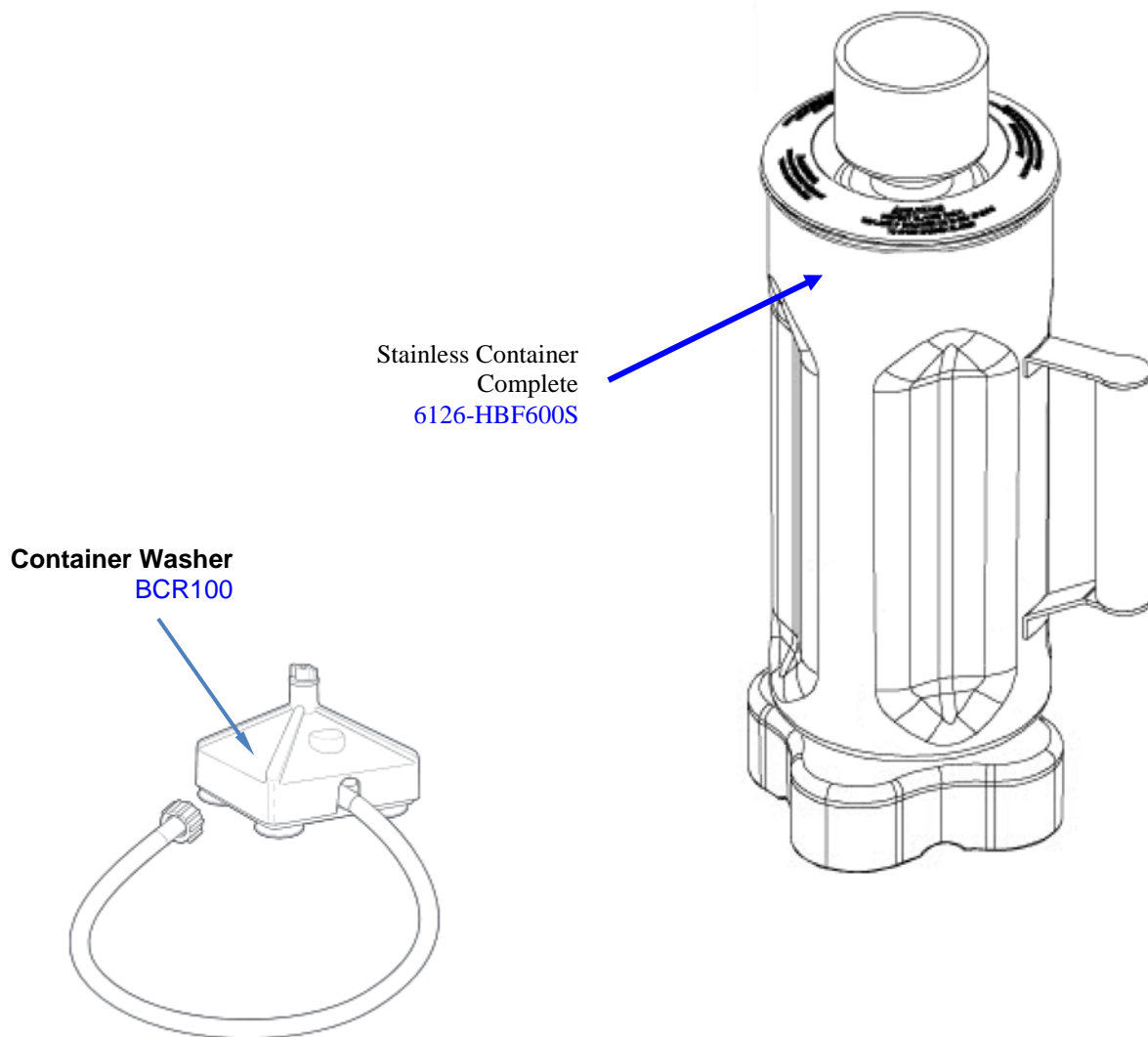

<b>Hamilton Beach</b> 4421 Waterfront Drive Glen Allen, VA 23060	Revision Description:		Add Food Bands				
	Request Number:	DOC9613	Revision Date:	12/27/2018	Approved by:	DOC9613	
	Issue Code(s):	CS, SP	Page:	5 of 5	Document #:	540003400	Rev: