

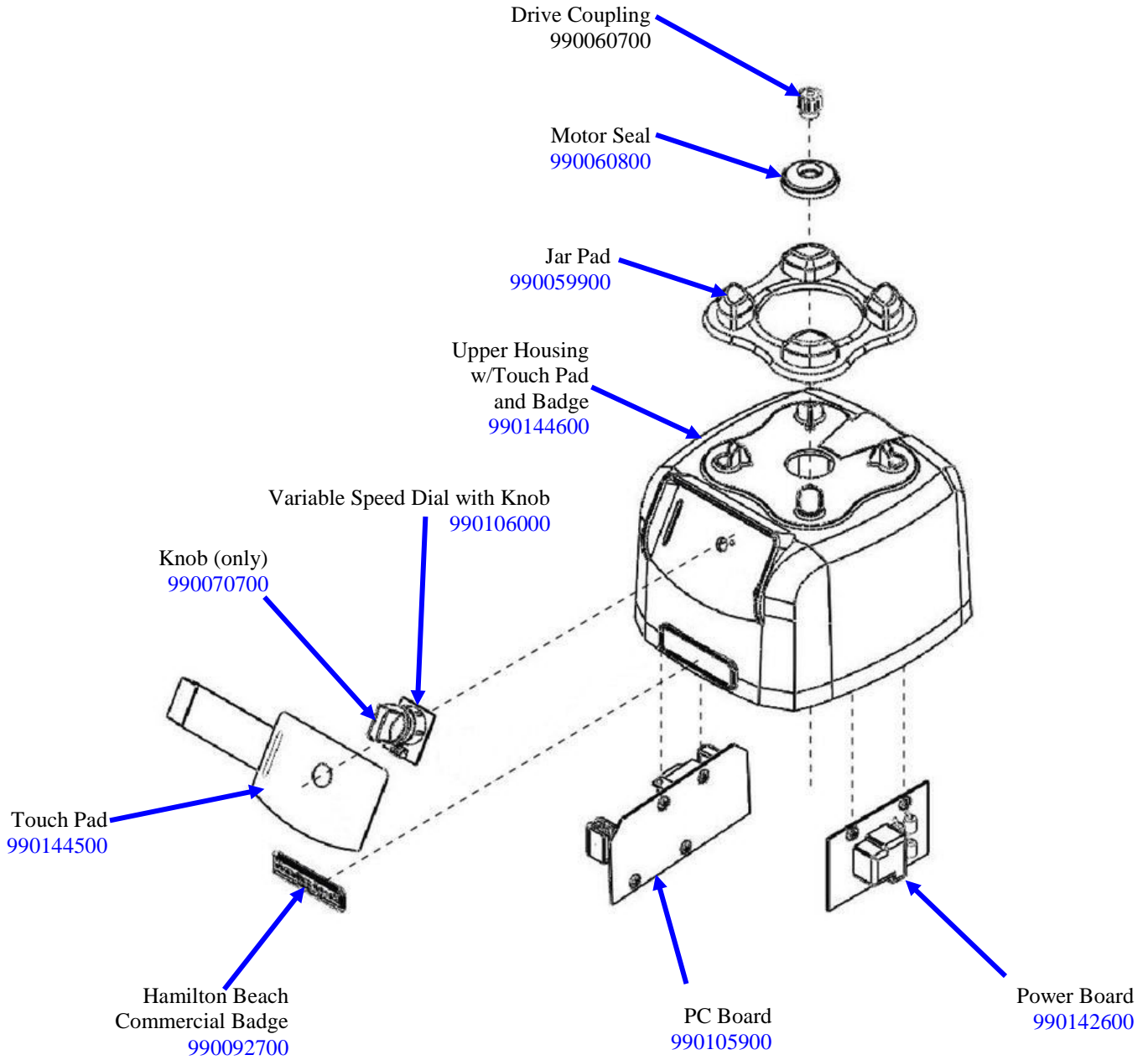

## Replacement Parts Diagrams

### HBF600-CCC

**PROPRIETARY RIGHTS NOTICE** This document and all information contained within it is the property of Hamilton Beach Brands, Inc. (HBB). It is confidential and proprietary and has been provided to you for a limited purpose. It must be returned or destroyed upon request. Disclosure, reproduction or use of this document and any information contained within it, in full or in part, for any purpose is forbidden without the prior written consent of HBB. No photographs may be taken of any article fabricated or assembled from this document without the prior written consent of HBB.



|  |                                      |              |                           |                       |                      |  |
|--|--------------------------------------|--------------|---------------------------|-----------------------|----------------------|--|
|  <p>Hamilton Beach<br/>4421 Waterfront Drive<br/>Glen Allen, VA 23060</p> | Revision Description: Add Food Bands |              | Revision Date: 12/27/2018 |                       | Approved by: DOC9613 |  |
|  | Request Number: DOC9613              | Page: 1 of 5 |                           | Document #: 540004800 | Rev: G               |  |
|  | Issue Code(s):                       |              |                           |                       |                      |  |

## Replacement Parts Diagrams

### HBF600-CCC

**PROPRIETARY RIGHTS NOTICE** This document and all information contained within it is the property of Hamilton Beach Brands, Inc. (HBB). It is confidential and proprietary and has been provided to you for a limited purpose. It must be returned or destroyed upon request. Disclosure, reproduction or use of this document and any information contained within it, in full or in part, for any purpose is forbidden without the prior written consent of HBB. No photographs may be taken of any article fabricated or assembled from this document without the prior written consent of HBB.

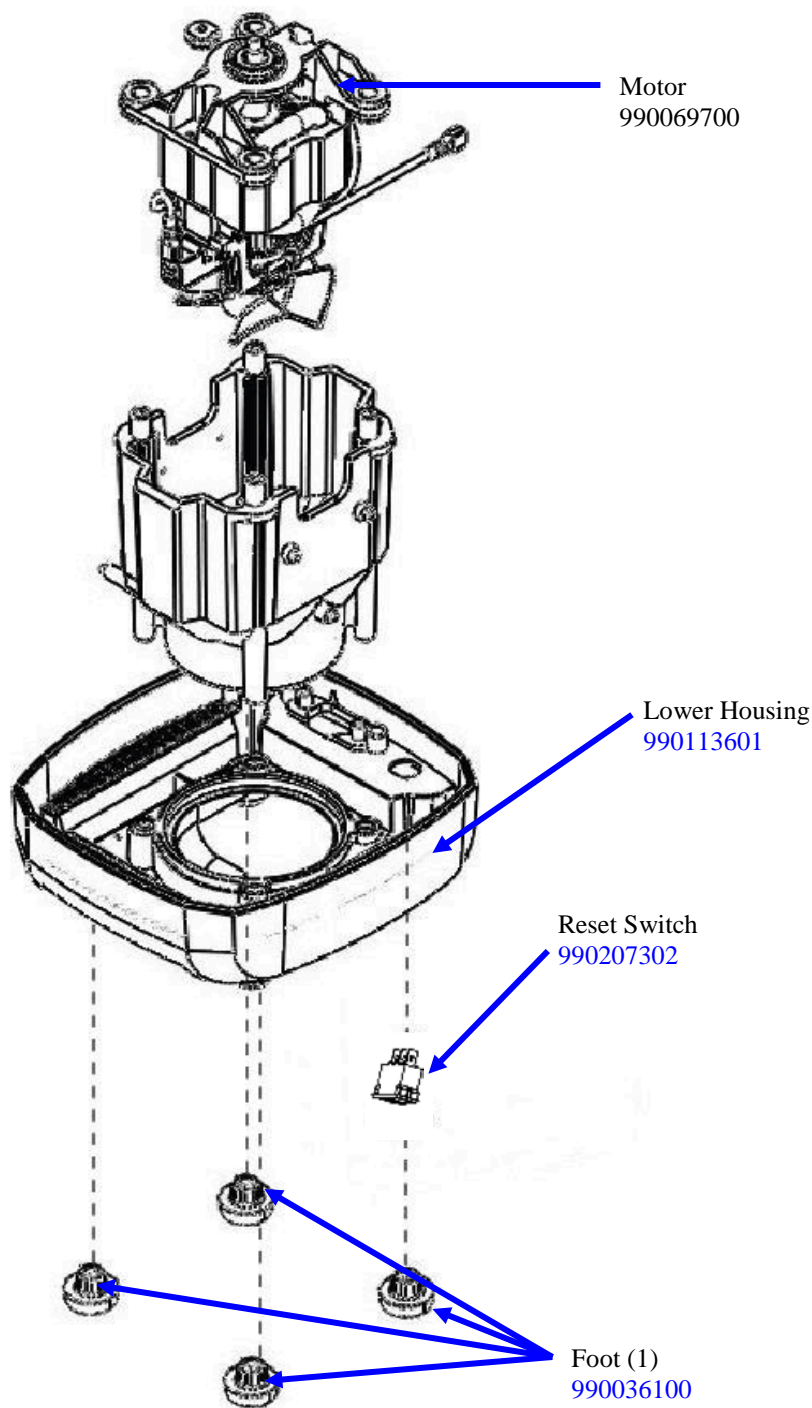

**Not Shown:**

- Power Cord – 990054201
- Cord Socket – 990064800
- Motor Brush Kits – 990075300
- Jar Sensor – 990084400

|   |                                      |         |                |            |              |           |      |   |
|---|--------------------------------------|---------|----------------|------------|--------------|-----------|------|---|
| <br>Hamilton Beach<br>4421 Waterfront Drive<br>Glen Allen, VA 23060 | Revision Description: Add Food Bands |         |                |            |              |           |      |   |
|   | Request Number:                      | DOC9613 | Revision Date: | 12/27/2018 | Approved by: | DOC9613   |      |   |
|   | Issue Code(s):                       |         | Page:          | 2 of 5     | Document #:  | 540004800 | Rev: | G |

## Replacement Parts Diagrams

### HBF600-CCC

**PROPRIETARY RIGHTS NOTICE** This document and all information contained within it is the property of Hamilton Beach Brands, Inc. (HBB). It is confidential and proprietary and has been provided to you for a limited purpose. It must be returned or destroyed upon request. Disclosure, reproduction or use of this document and any information contained within it, in full or in part, for any purpose is forbidden without the prior written consent of HBB. No photographs may be taken of any article fabricated or assembled from this document without the prior written consent of HBB.

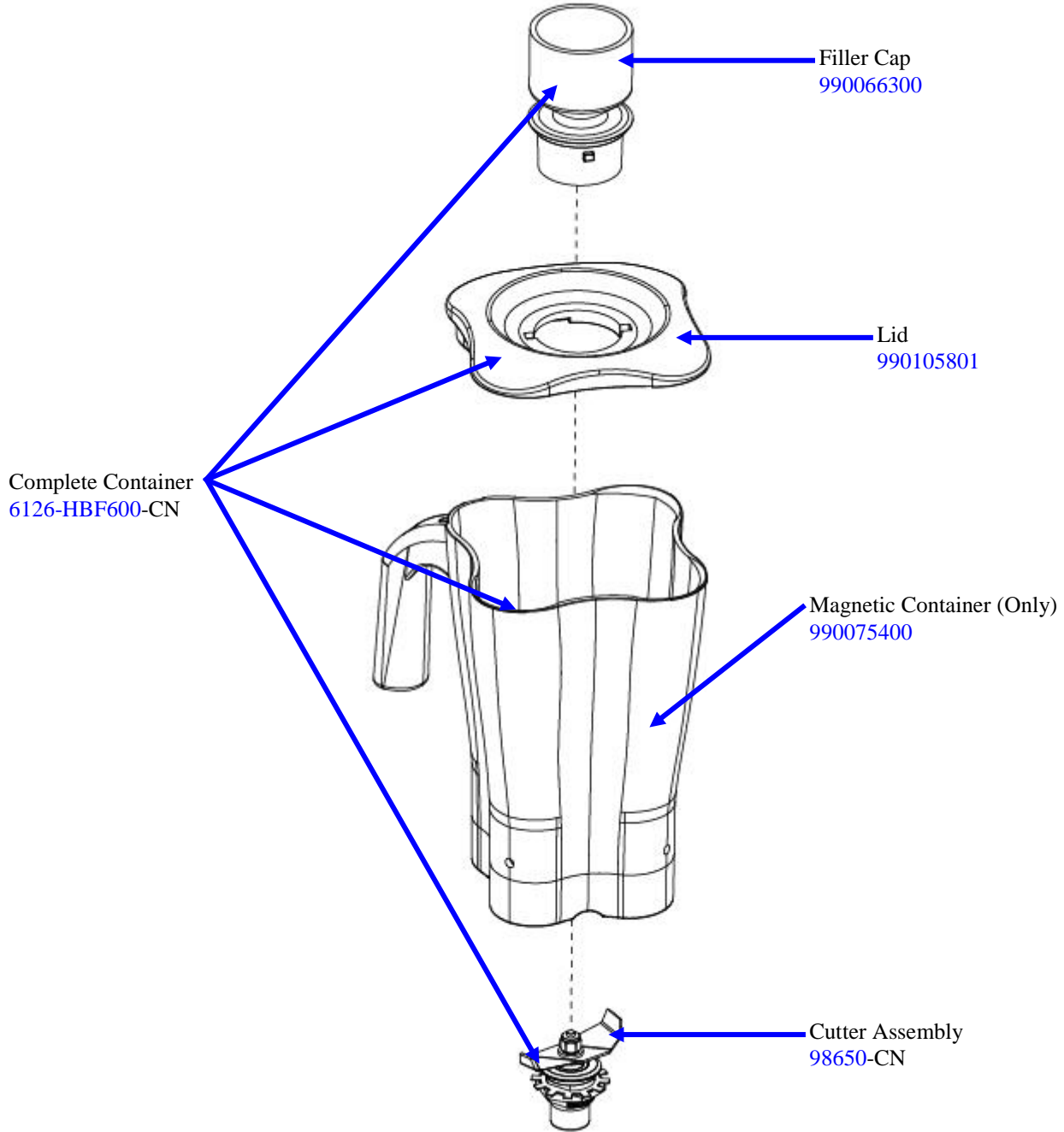

|  |                                      |         |                |            |              |           |      |   |
|--|--------------------------------------|---------|----------------|------------|--------------|-----------|------|---|
| <br>Hamilton Beach<br>4421 Waterfront Drive<br>Glen Allen, VA 23060 | Revision Description: Add Food Bands |         |                |            |              |           |      |   |
|  | Request Number:                      | DOC9613 | Revision Date: | 12/27/2018 | Approved by: | DOC9613   |      |   |
|  | Issue Code(s):                       |         | Page:          | 3 of 5     | Document #:  | 540004800 | Rev: | G |

## Replacement Parts Diagrams

### HBF600-CCC

**PROPRIETARY RIGHTS NOTICE** This document and all information contained within it is the property of Hamilton Beach Brands, Inc. (HBB). It is confidential and proprietary and has been provided to you for a limited purpose. It must be returned or destroyed upon request. Disclosure, reproduction or use of this document and any information contained within it, in full or in part, for any purpose is forbidden without the prior written consent of HBB. No photographs may be taken of any article fabricated or assembled from this document without the prior written consent of HBB.

### Band Complete Set – 990123600 (includes all bands below).



**Food Band, Purple (Allergy)**

P/N - 990123100

**Food Band, White (Cheese)**

P/N - 990123200



**Food Band, Red (Meat)**

P/N - 990123400



**Food Band, Brown (Seafood)**

P/N - 990123300



**Food Band, Green (Vegetables)**

P/N - 990123500



|  |                       |                |                |            |              |           |      |   |
|--|-----------------------|----------------|----------------|------------|--------------|-----------|------|---|
| <br>4421 Waterfront Drive<br>Glen Allen, VA 23060 | Revision Description: | Add Food Bands |                |            |              |           |      |   |
|  | Request Number:       | DOC9613        | Revision Date: | 12/27/2018 | Approved by: | DOC9613   |      |   |
|  | Issue Code(s):        |                | Page:          | 4 of 5     | Document #:  | 540004800 | Rev: | G |

## Replacement Parts Diagrams

### HBF600-CCC

**PROPRIETARY RIGHTS NOTICE** This document and all information contained within it is the property of Hamilton Beach Brands, Inc. (HBB). It is confidential and proprietary and has been provided to you for a limited purpose. It must be returned or destroyed upon request. Disclosure, reproduction or use of this document and any information contained within it, in full or in part, for any purpose is forbidden without the prior written consent of HBB. No photographs may be taken of any article fabricated or assembled from this document without the prior written consent of HBB.

## Accessories

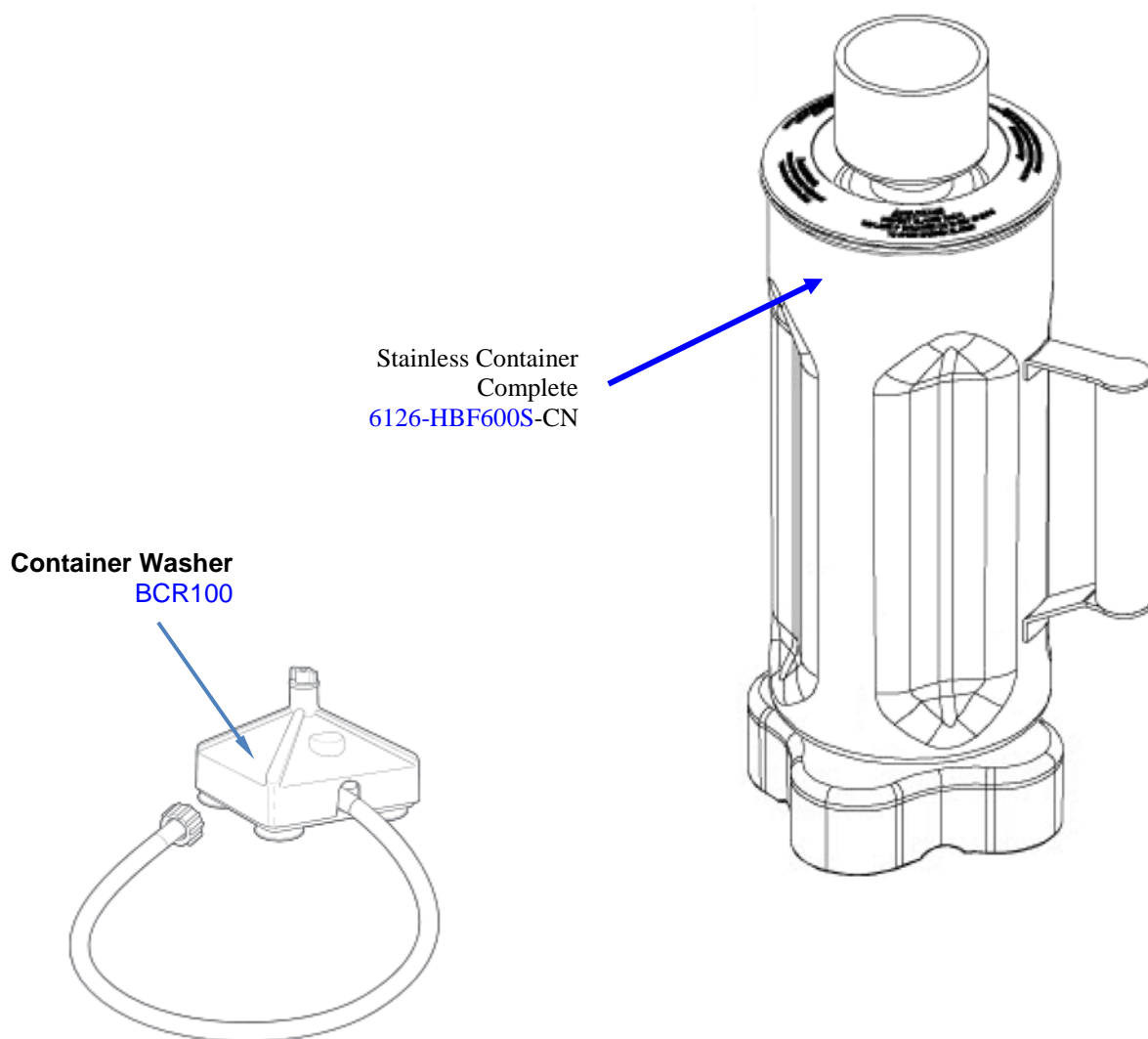

|  |                       |                |                |            |              |           |      |   |
|--|-----------------------|----------------|----------------|------------|--------------|-----------|------|---|
| <b>Hamilton Beach</b><br>4421 Waterfront Drive<br>Glen Allen, VA 23060 | Revision Description: | Add Food Bands |                |            |              |           |      |   |
|  | Request Number:       | DOC9613        | Revision Date: | 12/27/2018 | Approved by: | DOC9613   |      |   |
|  | Issue Code(s):        |                | Page:          | 5 of 5     | Document #:  | 540004800 | Rev: | G |