

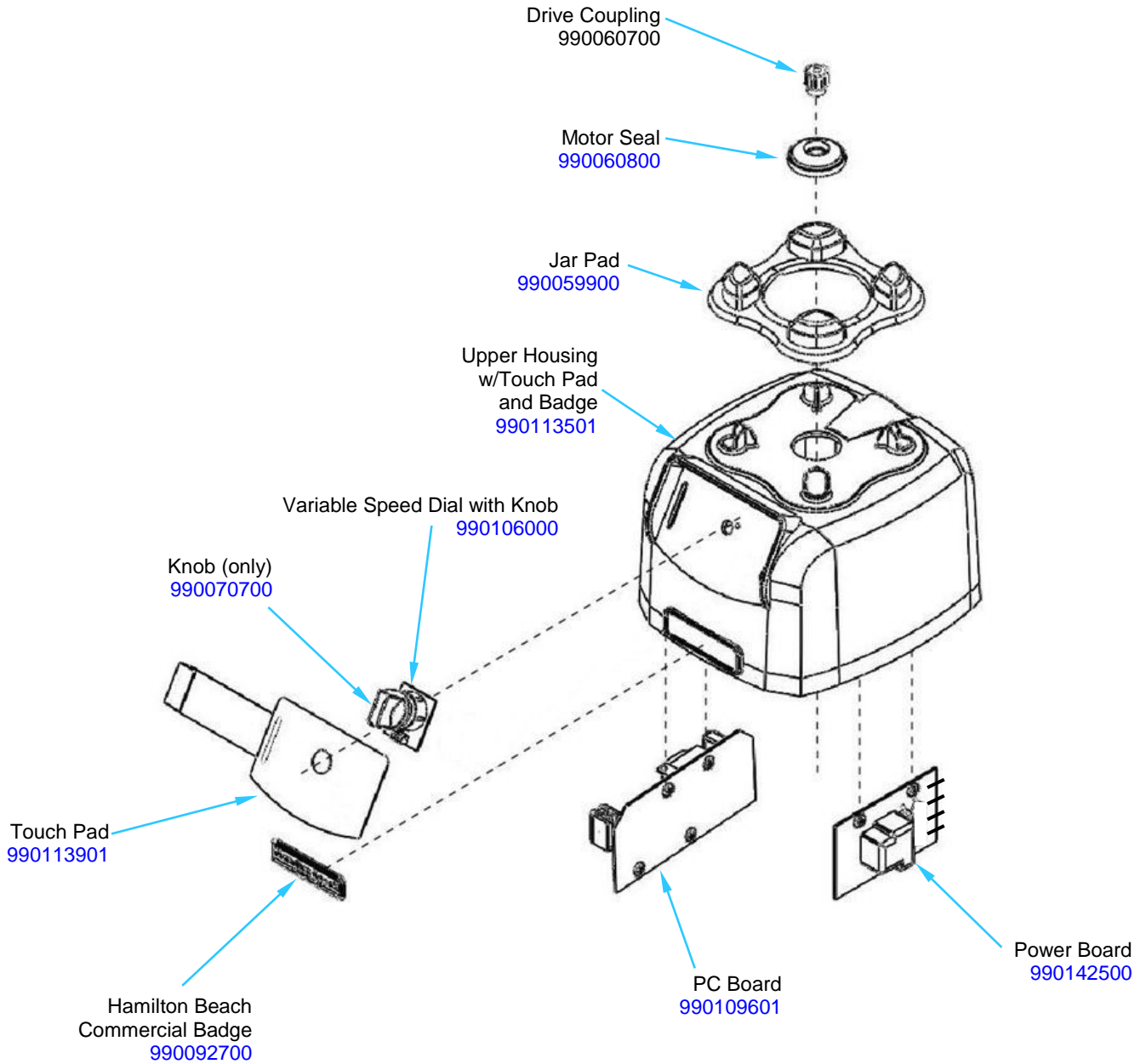

Replacement Parts Diagrams

HBF600S

PROPRIETARY RIGHTS NOTICE This document and all information contained within it is the property of Hamilton Beach Brands, Inc. (HBB). It is confidential and proprietary and has been provided to you for a limited purpose. It must be returned or destroyed upon request. Disclosure, reproduction or use of this document and any information contained within it, in full or in part, for any purpose is forbidden without the prior written consent of HBB. No photographs may be taken of any article fabricated or assembled from this document without the prior written consent of HBB.



 4421 Waterfront Drive Glen Allen, VA 23060	Revision Description:		Production Release												
	Request Number:		DOC6536		Revision Date:		2/22/16		Approved by:		DOC6536				
	Issue Code(s):		CS, SP		Page:		1 of 4		Document #:		540010700		Rev:		A

Replacement Parts Diagrams

HBF600S

PROPRIETARY RIGHTS NOTICE This document and all information contained within it is the property of Hamilton Beach Brands, Inc. (HBB). It is confidential and proprietary and has been provided to you for a limited purpose. It must be returned or destroyed upon request. Disclosure, reproduction or use of this document and any information contained within it, in full or in part, for any purpose is forbidden without the prior written consent of HBB. No photographs may be taken of any article fabricated or assembled from this document without the prior written consent of HBB.

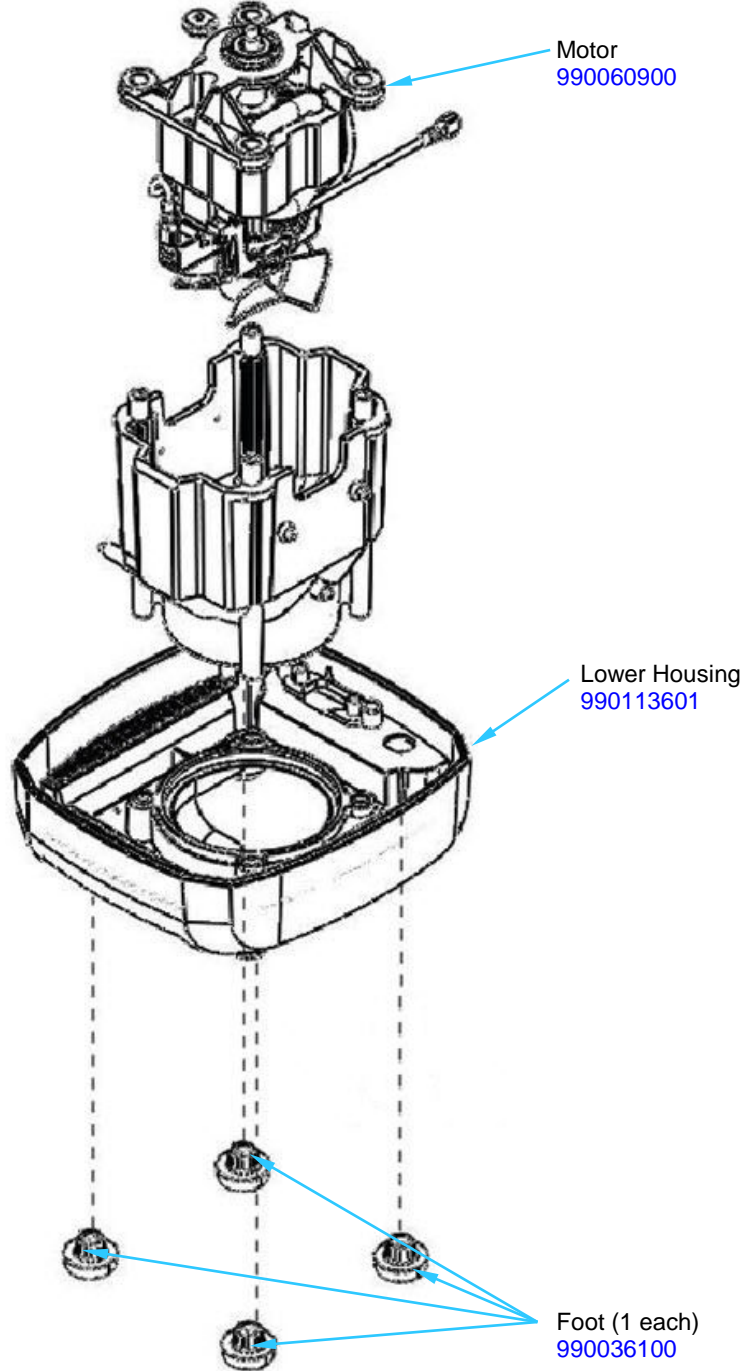

Not Shown:

- Power Cord – 990060600
- Cord Socket – 990064800
- Motor Brush Kits – 990075300
- Jar Sensor – 990084400
- Breaker Switch – 990114100

 4421 Waterfront Drive Glen Allen, VA 23060	Revision Description:		Production Release										
	Request Number:		DOC6536		Revision Date:		2/22/16		Approved by:		DOC6536		
	Issue Code(s):		CS, SP		Page:		2 of 4		Document #:		540010700		Rev:

Replacement Parts Diagrams

HBF600S

PROPRIETARY RIGHTS NOTICE This document and all information contained within it is the property of Hamilton Beach Brands, Inc. (HBB). It is confidential and proprietary and has been provided to you for a limited purpose. It must be returned or destroyed upon request. Disclosure, reproduction or use of this document and any information contained within it, in full or in part, for any purpose is forbidden without the prior written consent of HBB. No photographs may be taken of any article fabricated or assembled from this document without the prior written consent of HBB.

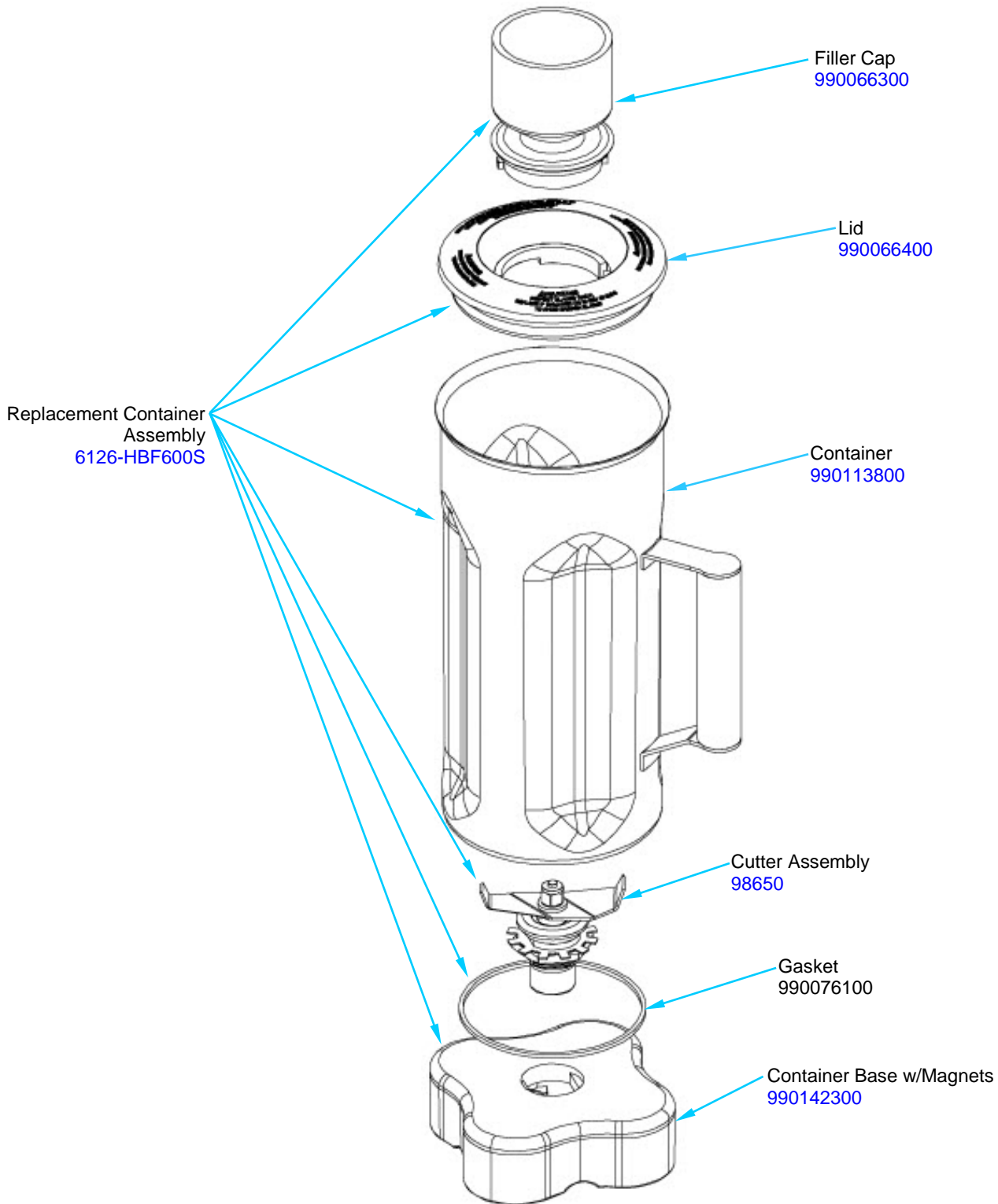

 4421 Waterfront Drive Glen Allen, VA 23060	Revision Description:		Production Release				
	Request Number:	DOC6536	Revision Date:	2/22/16	Approved by:	DOC6536	
	Issue Code(s):	CS, SP	Page:	3 of 4	Document #:	540010700	Rev:

Replacement Parts Diagrams

HBF600S

PROPRIETARY RIGHTS NOTICE This document and all information contained within it is the property of Hamilton Beach Brands, Inc. (HBB). It is confidential and proprietary and has been provided to you for a limited purpose. It must be returned or destroyed upon request. Disclosure, reproduction or use of this document and any information contained within it, in full or in part, for any purpose is forbidden without the prior written consent of HBB. No photographs may be taken of any article fabricated or assembled from this document without the prior written consent of HBB.

ACCESSORIES

Container Washer
BCR100

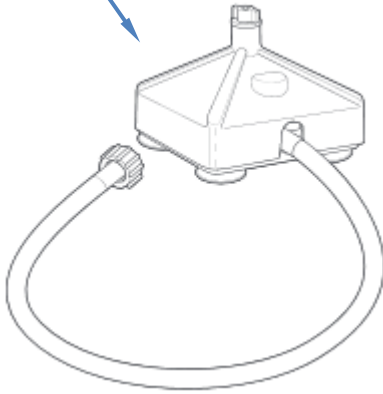

Container Complete
6126-HBF600

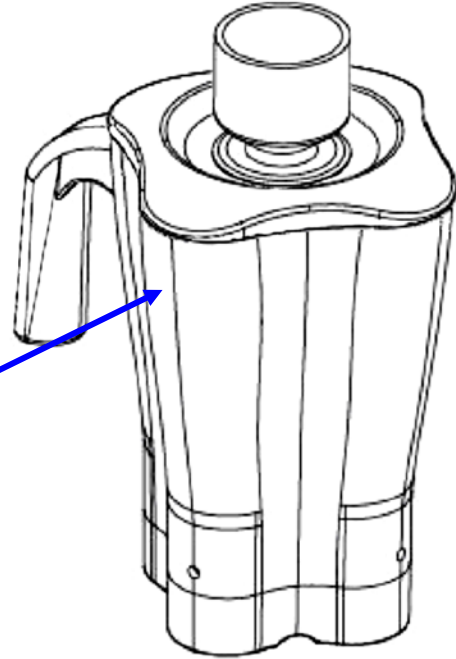

 4421 Waterfront Drive Glen Allen, VA 23060	Revision Description:		Production Release					
	Request Number:	DOC6536	Revision Date:	2/22/16	Approved by:	DOC6536		
	Issue Code(s):	CS, SP	Page:	4 of 4	Document #:	540010700	Rev:	A