

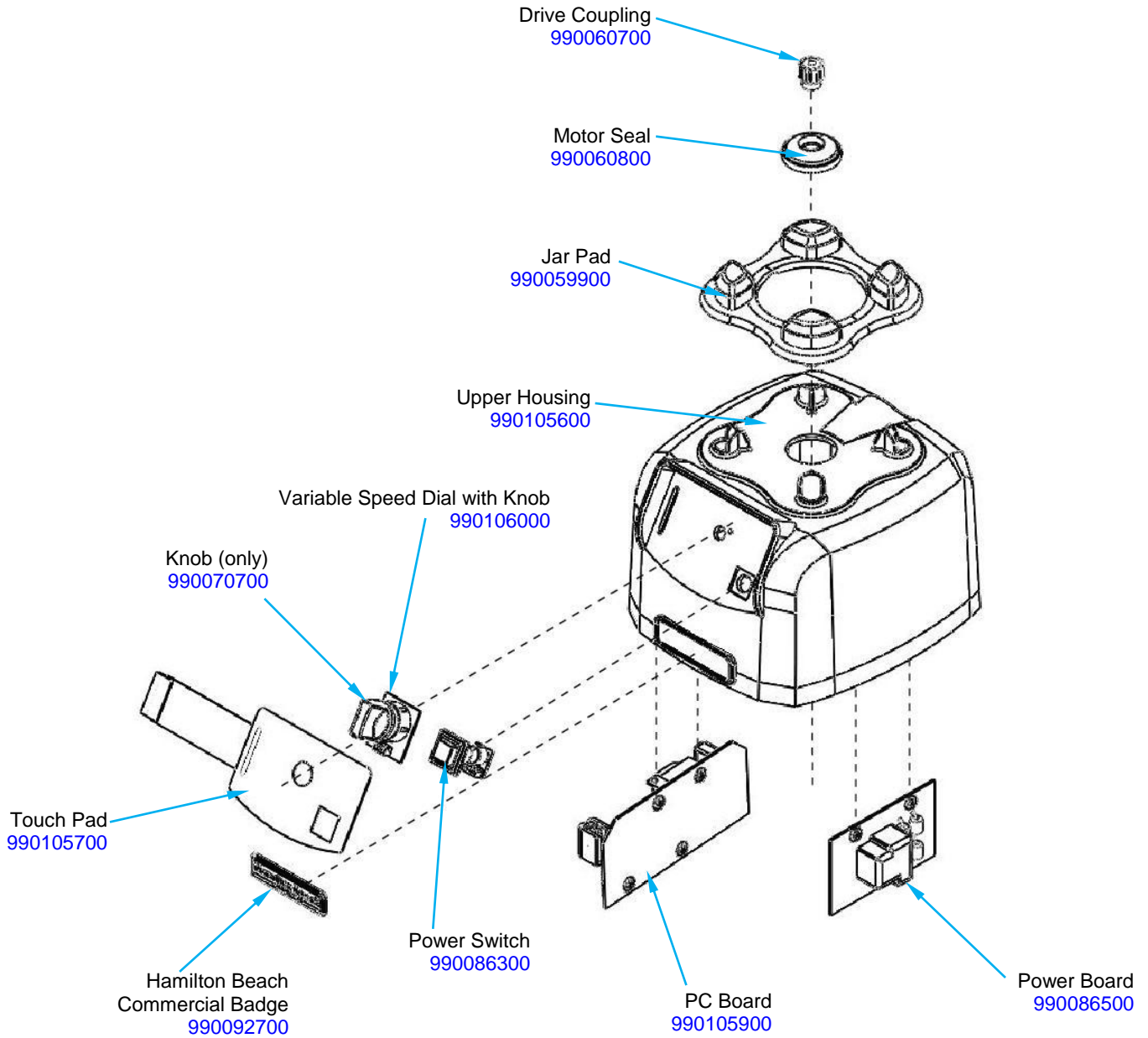

## Replacement Parts Diagrams HBF600S-CE (Series A)

**PROPRIETARY RIGHTS NOTICE** This document and all information contained within it is the property of Hamilton Beach Brands, Inc. (HBB). It is confidential and proprietary and has been provided to you for a limited purpose. It must be returned or destroyed upon request. Disclosure, reproduction or use of this document and any information contained within it, in full or in part, for any purpose is forbidden without the prior written consent of HBB. No photographs may be taken of any article fabricated or assembled from this document without the prior written consent of HBB.



 4421 Waterfront Drive Glen Allen, VA 23060	Revision Description: Add Accessories							
	Request Number:	DOC4464	Revision Date:	2/18/14	Approved by:	DOC4464		
	Issue Code(s):	CS, SP	Page:	1 of 4	Document #:	<b>540004100</b>	Rev:	<b>B</b>

**Replacement Parts Diagrams**  
**HBF600S-CE (Series A)**

**PROPRIETARY RIGHTS NOTICE** This document and all information contained within it is the property of Hamilton Beach Brands, Inc. (HBB). It is confidential and proprietary and has been provided to you for a limited purpose. It must be returned or destroyed upon request. Disclosure, reproduction or use of this document and any information contained within it, in full or in part, for any purpose is forbidden without the prior written consent of HBB. No photographs may be taken of any article fabricated or assembled from this document without the prior written consent of HBB.

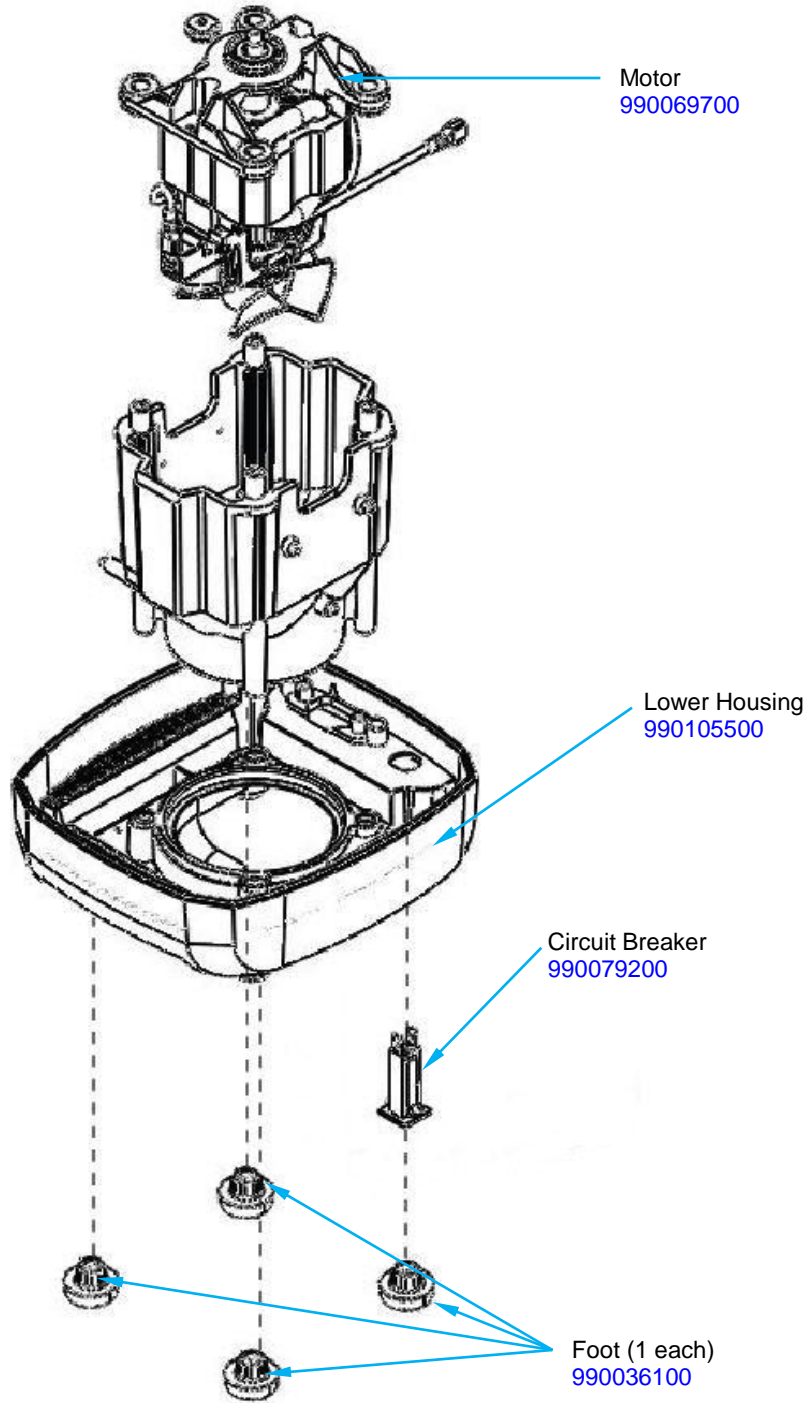

**Not Shown:**

- Power Cord – 990054200
- Cord Socket – 990064800
- Motor Brush Kits – 990075300
- Jar Sensor - 990084400

 4421 Waterfront Drive Glen Allen, VA 23060	Revision Description:	Add Accessories					
	Request Number:	DOC4464	Revision Date:	2/18/14	Approved by:	DOC4464	
	Issue Code(s):	CS, SP	Page:	2 of 4	Document #:	<b>540004100</b>	Rev:

## Replacement Parts Diagrams HBF600S-CE (Series A)

**PROPRIETARY RIGHTS NOTICE** This document and all information contained within it is the property of Hamilton Beach Brands, Inc. (HBB). It is confidential and proprietary and has been provided to you for a limited purpose. It must be returned or destroyed upon request. Disclosure, reproduction or use of this document and any information contained within it, in full or in part, for any purpose is forbidden without the prior written consent of HBB. No photographs may be taken of any article fabricated or assembled from this document without the prior written consent of HBB.

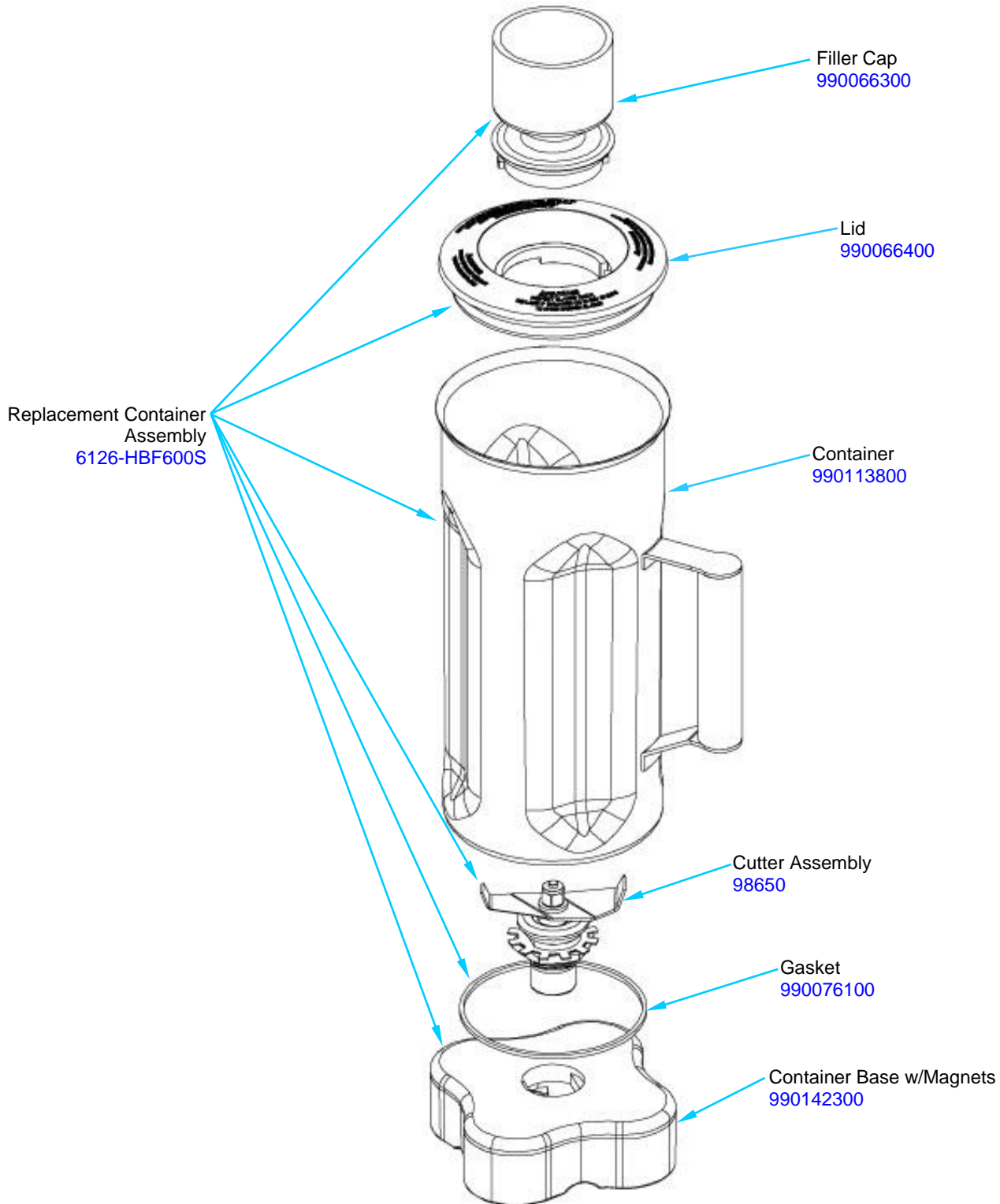

 4421 Waterfront Drive Glen Allen, VA 23060	Revision Description:		Add Accessories				
	Request Number:	DOC4464	Revision Date:	2/18/14	Approved by:	DOC4464	
	Issue Code(s):	CS, SP	Page:	3 of 4	Document #:	<b>540004100</b>	Rev:

**Replacement Parts Diagrams**  
**HBF600S-CE (Series A)**

**PROPRIETARY RIGHTS NOTICE** This document and all information contained within it is the property of Hamilton Beach Brands, Inc. (HBB). It is confidential and proprietary and has been provided to you for a limited purpose. It must be returned or destroyed upon request. Disclosure, reproduction or use of this document and any information contained within it, in full or in part, for any purpose is forbidden without the prior written consent of HBB. No photographs may be taken of any article fabricated or assembled from this document without the prior written consent of HBB.

**ACCESSORIES**

**Container Washer**  
BCR100

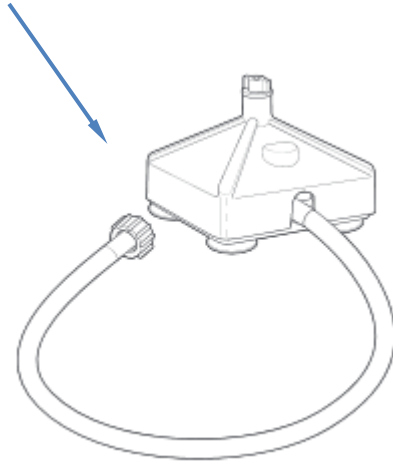

**Container Complete**  
6126-HBF600

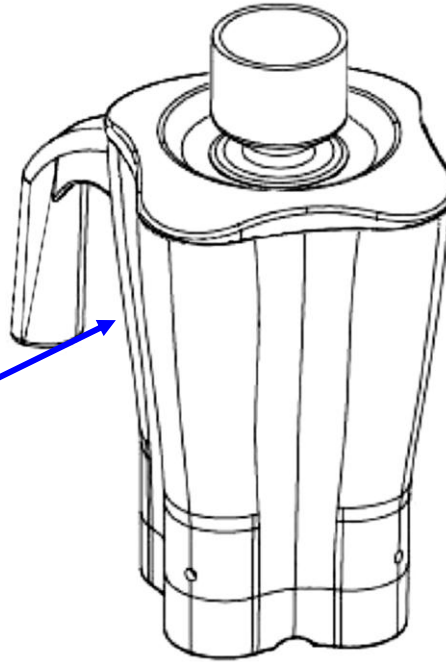

 4421 Waterfront Drive Glen Allen, VA 23060	Revision Description:		Add Accessories				
	Request Number:	DOC4464	Revision Date:	2/18/14	Approved by:	DOC4464	
	Issue Code(s):	CS, SP	Page:	4 of 4	Document #:	<b>540004100</b>	Rev: