

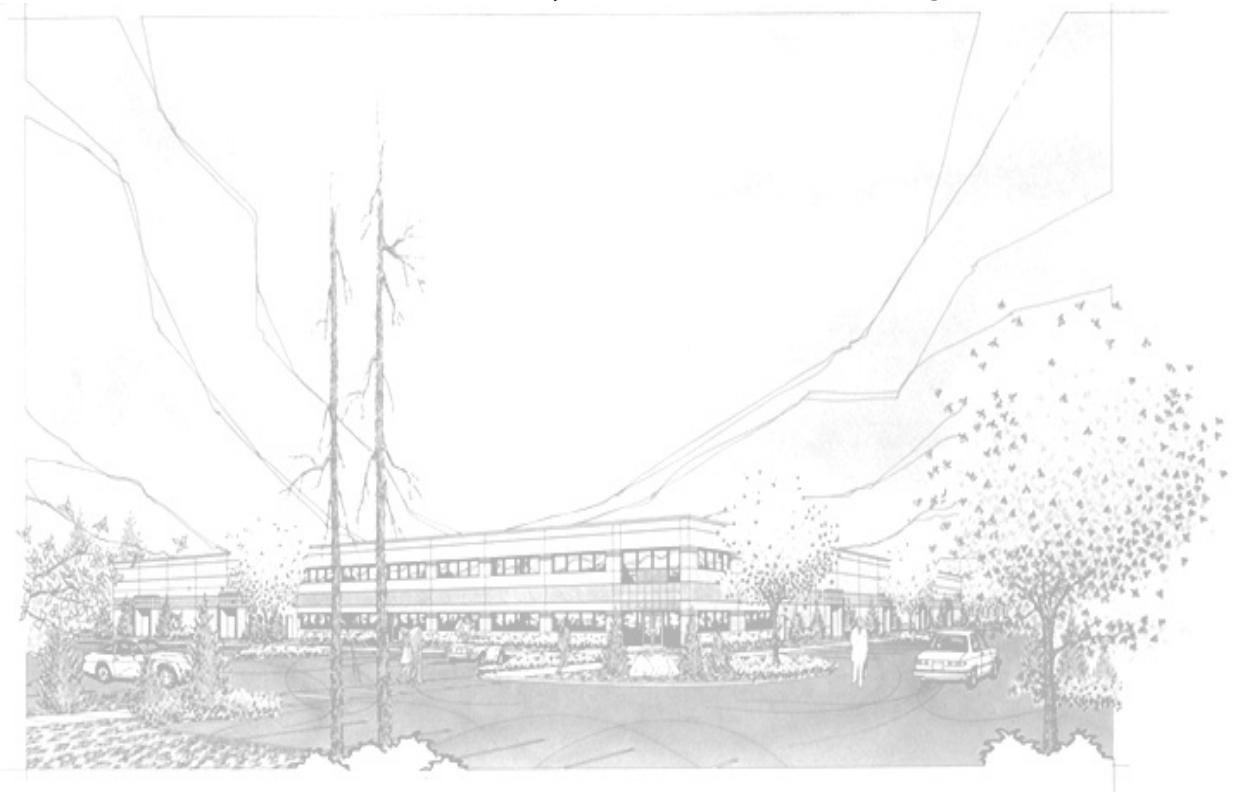

Installation, Operation, Maintenance, & Troubleshooting
Model: 500S, Standard Bake Oven Range



THIS MANUAL MUST BE RETAINED FOR FUTURE REFERENCE. READ, UNDERSTAND AND FOLLOW THE INSTRUCTIONS AND WARNINGS CONTAINED IN THIS MANUAL.

FOR YOUR SAFETY
DO NOT STORE OR USE GASOLINE OR OTHER FLAMMABLE VAPORS AND LIQUIDS IN THE VICINITY OF THIS OR ANY OTHER APPLIANCE.
POST IN A PROMINENT LOCATION
INSTRUCTIONS TO BE FOLLOWED IN THE EVENT USER SMELLS GAS. THIS INFORMATION SHALL BE OBTAINED BY CONSULTING YOUR LOCAL GAS SUPPLIER. AS A MINIMUM, TURN OFF THE GAS AND CALL YOUR GAS COMPANY AND YOUR AUTHORIZED SERVICE AGENT. EVACUATE ALL PERSONNEL FROM THE AREA.
WARNING: IMPROPER INSTALLATION, ADJUSTMENT, ALTERATION, SERVICE OR MAINTENANCE CAN CAUSE PROPERTY DAMAGE, INJURY OR DEATH. READ THE INSTALLATION, OPERATING AND MAINTENANCE INSTRUCTIONS THOROUGHLY BEFORE INSTALLING OR SERVICING THIS EQUIPMENT.

Model #:	Purchased From:
Serial #:	Location:
Date Purchased:	Date Installed:
Purchase Order #:	For Service, Call:

TABLE OF CONTENTS

CHAPTER	PAGE
1. TABLE OF CONTENTS	3
2. READ FIRST	4
3. EQUIPMENT DESCRIPTION	6
4. UNPACKING.....	7
5. INSTALLATION	8
6. INITIAL START-UP.....	9
7. OPERATION.....	10
8. CLEANING & MAINTENANCE PROCEDURES.....	12
9. TROUBLESHOOTING	13
10. PARTS LISTS	15
11. WIRING DIAGRAMS	17
12. WARRANTY	20

CAUTION: THE RANGE WEIGHS 900 LBS. (408 KILOGRAMS). FOR SAFE HANDLING, INSTALLER SHOULD OBTAIN HELP AS NEEDED, OR EMPLOY APPROPRIATE MATERIALS HANDLING EQUIPMENT (SUCH AS A FORKLIFT, DOLLY, OR PALLET JACK) TO REMOVE THE UNIT FROM THE SKID AND MOVE IT TO THE PLACE OF INSTALLATION.



CAUTION: ANY STAND, COUNTER OR OTHER DEVICE ON WHICH RANGE WILL BE LOCATED MUST BE DESIGNED TO SUPPORT THE WEIGHT OF THE RANGE (900 LBS.).



CAUTION: SHIPPING STRAPS ARE UNDER TENSION AND CAN SNAP BACK WHEN CUT.



DANGER: THIS APPLIANCE MUST BE GROUNDED AT THE TERMINAL PROVIDED. FAILURE TO GROUND THE APPLIANCE COULD RESULT IN ELECTROCUTION AND DEATH.



WARNING: INSTALLATION OF THE UNIT MUST BE DONE BY PERSONNEL QUALIFIED TO WORK WITH ELECTRICITY AND PLUMBING. IMPROPER INSTALLATION CAN CAUSE INJURY TO PERSONNEL AND/OR DAMAGE TO EQUIPMENT. UNIT MUST BE INSTALLED IN ACCORDANCE WITH ALL APPLICABLE CODES.



NOTICE: The data plate is located right of Range top controls and circuit breaker door on oven. The oven voltage, wattage, serial number, wire size, and clearance specifications are on the data plate. This information should be carefully read and understood before proceeding with the installation.



NOTICE: The installation of any components such as a vent hood, grease extractors, fire extinguisher systems, must conform to their applicable National, State and locally recognized installation standards.



NOTICE: During the first few hours of operation you may notice a small amount of smoke coming off the unit, and a faint odor from the smoke. This is normal for a new range and will disappear after the first few hours of use.



CAUTION: ALWAYS KEEP THE AREA NEAR THE APPLIANCE FREE FROM COMBUSTIBLE MATERIALS.



CAUTION: KEEP FLOOR IN FRONT OF EQUIPMENT CLEAN AND DRY. IF SPILLS OCCUR, CLEAN IMMEDIATELY, TO AVOID THE DANGER OF SLIPS OR FALLS.



IMPORTANT

READ FIRST

IMPORTANT

WARNING: KEEP WATER AND SOLUTIONS OUT OF CONTROLS. NEVER SPRAY OR HOSE CONTROL CONSOLE, ELECTRICAL CONNECTIONS, ETC.



CAUTION: MOST CLEANERS ARE HARMFUL TO THE SKIN, EYES, MUCOUS MEMBRANES AND CLOTHING. PRECAUTIONS SHOULD BE TAKEN TO WEAR RUBBER GLOVES, GOGGLES OR FACE SHIELD AND PROTECTIVE CLOTHING. CAREFULLY READ THE WARNING AND FOLLOW THE DIRECTIONS ON THE LABEL OF THE CLEANER TO BE USED.



NOTICE: Service on this, or any other, LANG appliance must be performed by qualified personnel only. Consult your authorized service station directory or call the factory at 1-800-224-LANG (5264), or WWW.LANGWORLD.COM For the service station nearest you.



WARNING: BOTH HIGH AND LOW VOLTAGES ARE PRESENT INSIDE THIS APPLIANCE WHEN THE UNIT IS PLUGGED/WIRED INTO A LIVE RECEPTACLE. BEFORE REPLACING ANY PARTS, DISCONNECT THE UNIT FROM THE ELECTRIC POWER SUPPLY.



CAUTION: USE OF ANY REPLACEMENT PARTS OTHER THAN THOSE SUPPLIED BY LANG OR THEIR AUTHORIZED DISTRIBUTORS CAN CAUSE BODILY INJURY TO THE OPERATOR AND DAMAGE TO THE EQUIPMENT AND WILL VOID ALL WARRANTIES.



EQUIPMENT DESCRIPTION

Lang Model: 500S Double Bake Oven Range

Exterior

The Range dimensions are 30" (76.2cm) High, 35" (89.0cm) Deep, and 60" (152.5cm) Wide.

The Sides, Bottom, and Rear wall are constructed stainless steel.

The Range surface can come in 7 different configurations.

Controls

The 500 Series Rang is available with various controls depending upon model number. Shown below is a layout of each top configuration with its proper model number and a brief description of the controls. All 500S Ranges have two or the same type of standard bake oven, which has two 3- heat switches, one to control the top element and one to control the bottom element. In addition, the oven has a thermostat that controls the overall temperature of the oven

500S-A

Five 12"x24" Hot tops controlled by five 850° Thermostats.

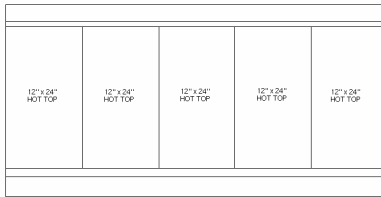

500S-B

Four 12"x24" Hot tops controlled by four 850° thermostats and two French plates controlled by two 6-heat switches.

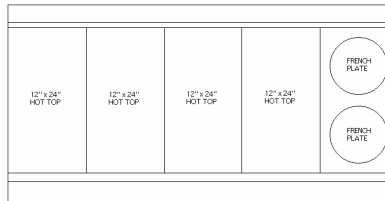

500S-C

24"x24" Griddle controlled by two 450° thermostats, two Hot tops controlled by two 850° thermostats, and two French plates controlled by two 6-heat switches.

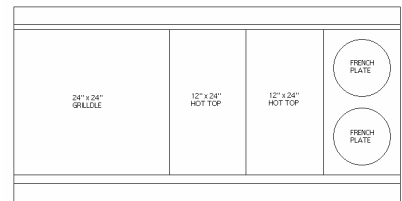

500S-D

36"x24" Griddle controlled by three 450° thermostats, 12"x24" Hot top controlled by one 850° thermostat and two French plates controlled by two 6-heat switches.

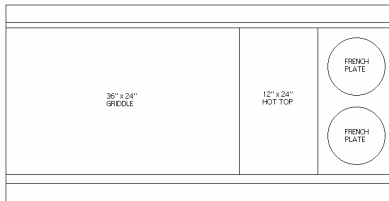

500S-E

48"x24" Griddle controlled by four 450° thermostats, and one 12"x24" Hot top controlled by one 850° thermostat.

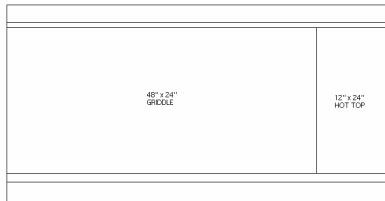

500S-F

48"x24" Griddle controlled by four 450° thermostats, and two French plates controlled by two 6-heat switches.

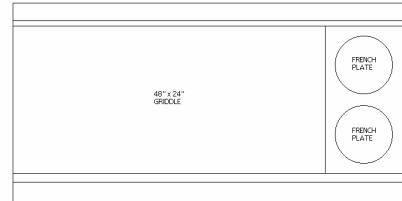

500S-G

60"x24" Griddle controlled by five 450° thermostats.

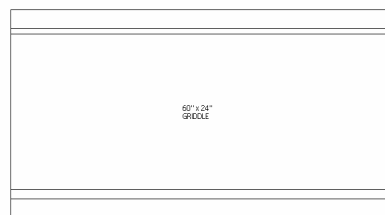

UNPACKING

Receiving the Oven

Upon receipt, check for freight damage, both visible and concealed. Visible damage should be noted on the freight bill at the time of delivery and signed by the carrier's agent. Concealed loss or damage means loss or damage which does not become apparent until the merchandise has been unpacked. If concealed loss or damage is discovered upon unpacking, make a written request for inspection by the carrier's agent within 15 days of delivery. All packing material should be kept for inspection. Do not return damaged merchandise to Lang Manufacturing Company. File your claim with the carrier.

Location

Prior to un-crating, move the range as near its intended location as practical. The crating will help protect the unit from the physical damage normally associated with moving it through hallways and doorways.

Un-crating

The range will arrive completely assembled inside a wood frame covered by cardboard box and strapped to a skid. **Remove the cardboard cover, cut the straps and remove the wood frame.**

CAUTION: RANGE WEIGHS 900 LBS (408 kilograms). FOR SAFE HANDLING, INSTALLER SHOULD OBTAIN HELP AS NEEDED, OR EMPLOY APPROPRIATE MATERIALS HANDLING EQUIPMENT (SUCH AS A FORKLIFT, DOLLY, OR PALLET JACK) TO REMOVE THE UNIT FROM THE SKID AND MOVE IT TO THE PLACE OF INSTALLATION.



CAUTION: ANY STAND, COUNTER OR OTHER DEVICE ON WHICH RANGE WILL BE LOCATED MUST BE DESIGNED TO SUPPORT THE WEIGHT OF THE OVEN (900 LBS.).



CAUTION: SHIPPING STRAPS ARE UNDER TENSION AND CAN SNAP BACK WHEN CUT.



Remove range from skid and place in intended location.

INSTALLING THE LEGS

Legs or Casters are available and must be specified upon ordering.

To install the 6-inch legs, remove the legs from the oven cavity, place some cardboard on the floor and gently tip the range onto its back. Fasten the legs into the threaded holes provided and then gently flip the oven onto its legs.

To install the 6-inch casters, remove the casters from the oven cavity, place some cardboard on the floor and gently tip the range onto its back. Attach the casters to the adapter plates. Gently tip the oven onto its casters.

INSTALLATION

DANGER: THIS APPLIANCE MUST BE GROUNDED AT THE TERMINAL PROVIDED. FAILURE TO GROUND THE APPLIANCE COULD RESULT IN ELECTROCUTION AND DEATH.



WARNING: INSTALLATION OF THE UNIT MUST BE DONE BY PERSONNEL QUALIFIED TO WORK WITH ELECTRICITY. IMPROPER INSTALLATION CAN CAUSE INJURY TO PERSONNEL AND/OR DAMAGE TO EQUIPMENT. UNIT MUST BE INSTALLED IN ACCORDANCE WITH ALL APPLICABLE CODES.



NOTICE: The data plate is located right of range top controls and behind the circuit breaker door on oven. The oven voltage, wattage, serial number, wire size, and clearance specifications are on the data plate. This information should be carefully read and understood before proceeding with the installation.



NOTICE: The installation of any components such as a vent hood, grease extractors, fire extinguisher systems, must conform to their applicable National, State and locally recognized installation standards.



ELECTRICAL CONNECTION

All connections can be made through 1 3/4" hole in the bottom of the oven.
Connections should be made to the wires coming from the circuit breaker.

WARNING: MAKE SURE THE MAIN POWER SUPPLY TO THE RANGE IS TURNED OFF AT THE SOURCE PRIOR TO CONNECTING POWER TO THE RANGE.



The range can now be connected to power.

CAUTION: BE SURE THE POWER SUPPLY VOLTAGE MATCHES THE VOLTAGE SPECIFIED ON THE NAMEPLATE LOCATED ON THE FRONT OF THE RANGE.



Total K.W. Conn	Three Phase									Single Phase	
	208 Volt			240 Volt			480 Volt			208 V	240 V
	L1	L2	L3	L1	L2	L3	L1	L2	L3	L1	L2
37.0	108.0	100.0	100.0	93.9	86.7	86.7	46.9	43.3	43.3	177.9	154.2

PHASING

POWER SUPPLY	TERMINAL BLOCK	RANGE TOP
SINGLE PHASE	L1	1,3,5,7,9
	L2	2,4,6,8,10
THREE PHASE	L1	1,4,7,10
	L2	2,5,8
	L3	3,6,9

INITIAL START UP

Prior to putting any range or oven into full time operation at normal cooking temperatures, it must be thoroughly "seasoned" or dried out. Moisture absorption in the closed spaces, in the insulation and even inside the heating elements can cause future trouble if not properly treated.

Before the initial use of the range, the ovens must be thoroughly allowed to dry out. This is done by setting the top and bottom oven switches to the "low" position, and setting the thermostat to 350 degrees. Allow the range ovens to saturate until all vapor and condensation has been eliminated. For best operating results allow the range ovens to thoroughly dry out. Allow 8 to 12 hours for this process. Clean top plates thoroughly. Apply salad oil. Turn each plate switch or thermostat to a low position and allow plate to heat for three hours.

If the unit is out of use for three or more days, a one hour preheat schedule should be used, especially when exposed to high humidity and/or cool temperatures.

NOTICE: During the first few hours of operation you may notice a small amount of smoke coming off the unit, and a faint odor from the smoke. This is normal for a new unit and will disappear after the first few hours of use.



OPERATION

Ovens

CAUTION: ALWAYS KEEP THE AREA NEAR THE APPLIANCE FREE FROM COMBUSTIBLE MATERIALS.



CAUTION: KEEP FLOOR IN FRONT OF EQUIPMENT CLEAN AND DRY. IF SPILLS OCCUR, CLEAN IMMEDIATELY, TO AVOID THE DANGER OF SLIPS OR FALLS.



The range ovens must be thoroughly, preheated before satisfactory baking can be done. The range ovens will not bake uniformly if not sufficiently preheated.

To compensate for temperature drop when loading the range ovens, set the thermostat up 50 degrees over the desired temperature. Reset thermostat after the ovens is loaded.

The range ovens may, of course, be preheated with the 3 heat switches set at a lower position than "High", but the time required will be proportionally longer. After preheating, set the two 3 heat switches for proper ratio of "top" and "bottom" heat to suit the product to be baked or roasted.

The 12" high "Roasting and Baking" range ovens is equipped with a removable rack. For baking pies, bread, or for roasting operations, the rack may be placed directly on the metal deck and the pans placed on the rack. For baking cakes or pastries the rack should be located in the lower position provided by the rack supports at the sides of the range and the pans placed on the rack in this lower position.

The following temperature, time, switch setting and rack positions are suggested as a guide in baking various classes of products:

General Class of Product	Average Range Temperature	Time (Min.)	With Metal Switch Settings		Rack Position
			Top	Bottom	
Pies	375-425	35-60	Low	Medium	Rack on Deck
Rolls	375-400	15-30	Low	High	Rack Support
Cake	350-400	20-45	Low	High	Rack Support
Pastries	325-375	8-20	Low	High	Rack Support
Bread	425-450	25-45	Low	Medium	Rack on Deck
Roast Beef	300-325		Low	High or Medium	Rack on Deck

RANGE TOP

Consists of the various top arrangements, depending on specific model purchased:

12" x 24" hot plate controlled by high temperature thermostats. Temperature ranges from 0°-850°. Recommended: Stock pots and heavy kettle work.

Round French Plates, controlled by indicating type 6-heat switch. Temperature ranges from 0°-750°. Recommended: Light duty sauce pans and small stockpots.

Not Recommended: Heavy stock pots, or heavy urns, or kettles.

60" x 24" or 48" x 24" or 36" x 24" or 24" x 24" grill plates, controlled by thermostats. Temperature ranges from 0°-450°. Recommended: All heavy and light frying. Set the thermostat dial at the desired temperature. The red pilot light will be on until the desired temperature is reached. The pilot light indicates when the plate is heating.

MAINTENANCE & CLEANING

Cleaning

WARNING: KEEP WATER AND SOLUTIONS OUT OF CONTROLS. NEVER SPRAY OR HOSE CONTROL CONSOLE, ELECTRICAL CONNECTIONS, ETC.



CAUTION: MOST CLEANERS ARE HARMFUL TO THE SKIN, EYES, MUCOUS MEMBRANES AND CLOTHING. PRECAUTIONS SHOULD BE TAKEN TO WEAR RUBBER GLOVES, GOGGLES OR FACE SHIELD AND PROTECTIVE CLOTHING. CAREFULLY READ THE WARNING AND FOLLOW THE DIRECTIONS ON THE LABEL OF THE CLEANER TO BE USED.



The range should be thoroughly cleaned at least once a week in addition to the normal daily cleaning to insure against the accumulation of foreign material. Keep inside of oven and metal deck clean, particularly around door opening, door edges and at bottom of door opening so that the door may close tightly.

NOTICE: Any oven cleaner used should be marked: "safe on aluminum".



Keep drip pans under range top plates clean.

Keep hotplate and griddle surfaces clean.

Outside of range and top should be kept clean.

Electric equipment is inherently clean and sanitary, but may become unsanitary if dirt is allowed to accumulate on it. Take advantage of the clean, sanitary features of electric equipment, give it the regular attention that it deserves the same as any other highly perfected machinery, to insure best results and continued high operating efficiency.

CALIBRATION

Calibration Check

- Place thermometer or thermocouple in the center of oven cavity.
- Set thermostat to 350° and place both 3-heat switches in the "HIGH" position.
- Allow the oven to Preheat for at least half an hour.
- Note cycle on temperatures and cycle off temperatures for 3 cycles. (Red indicator light indicates when oven is calling for heat)
- After 3 cycles average the temperature. (Add all six temperatures and divide by 6)

Calibration Adjustment

- A 1/16" flat blade screwdriver with a 2" shaft is required to make adjustments on the thermostat.
- Maintain the oven temperature at 350°.
- Without turning the thermostat, remove the knob.
- Locate the adjustment screw at the base of the shaft and insert the screwdriver.
- Grasp the shaft and turn the screwdriver. Counter clockwise to increase and clockwise to decrease (1/8 of a turn will move the temperature 5-7 ° in either direction).
- Reinstall the oven knob and recheck the oven temperature.

TROUBLESHOOTING

Symptoms

What follows is a chart of Symptoms, Possible Causes, and Remedy's to aid in diagnosing faults with the range.

Refer to the Symptoms column to locate the type of failure then to the Possible Cause for the items to be checked and the Remedy to column for possible solutions.

SYMPTOM	POSSIBLE CAUSE
Oven will not heat	<ul style="list-style-type: none">• No power to Range• Internal breaker tripped• Defective Thermostat• Defective 3-heat switch• Defective oven element
Range will not heat	<ul style="list-style-type: none">• No power to Range• Internal breaker tripped• Failed Thermostat or 6-heat switch• Failed element
Product is burning	<ul style="list-style-type: none">• Product is cooked too long• Failed Thermostat• Failed 3-heat switch
Product under done	<ul style="list-style-type: none">• Product is not cooking long enough• Failed thermostat• Failed 3-heat switch

TROUBLESHOOTING CONT'D

TESTS

NOTICE:

Service on this, or any other, LANG appliance must be performed by qualified personnel only. Consult your authorized service station directory or call the factory at 1-800-224-LANG (5264), or WWW.LANGWORLD.COM For the service station nearest you.



WARNING:

BOTH HIGH AND LOW VOLTAGES ARE PRESENT INSIDE THIS APPLIANCE WHEN THE UNIT IS PLUGGED/WIRED INTO A LIVE RECEPTACLE. BEFORE REPLACING ANY PARTS, DISCONNECT THE UNIT FROM THE ELECTRIC POWER SUPPLY.



If an item on the list is followed by an asterisk (*), the work should be done by a factory authorized service representative.

Possible Cause	TEST
Product is cooked too long	<ul style="list-style-type: none">• No test available, operational condition
Failed thermostat	<ul style="list-style-type: none">• Verify calibration.
Failed element	<ul style="list-style-type: none">• Remove the wires and check for continuity across the element*
Failed 3-heat or 6-heat switch	<ul style="list-style-type: none">• Call factory or consult Service manual for correct checks on each switch*
Failed or internal breaker	<ul style="list-style-type: none">• Reset breaker

CAUTION:

USE OF ANY REPLACEMENT PARTS OTHER THAN THOSE SUPPLIED BY LANG OR THEIR AUTHORIZED DISTRIBUTORS CAN CAUSE BODILY INJURY TO THE OPERATOR AND DAMAGE TO THE EQUIPMENT AND WILL VOID ALL WARRANTIES.



PARTS LIST

500S Standard Bake Oven Range

DESCRIPTION	PART NO.
Element Top Plate 208V O/S 2000 Watts	11010-09
Element Top Plate 208V I/S 3000 Watts	11010-10
Element Top Plate 240V O/S 2000 Watts	11010-21
Element Top Plate 240V I/S 3000 Watts	11010-22
Element Top Plate 480V O/S 2000 Watts	11010-23
Element Top Plate 480V I/S 3000 Watts	11010-24
Element Top Plate 380V O/S 2000 Watts	11010-25
Element Top Plate 380V I/S 3000 Watts	11010-26
Hot Plate Cast Assy. w/ Elements 208V 5000 Watts (After E-83890)	PS-11010-341
Hot Plate Cast Assy. w/ Elements 240V 5000 Watts (After E-83890)	PS-11010-351
Hot Plate Cast Assy. w/ Elements 480V 5000 Watts (After E-83890)	PS-11010-361
Element 36 Oven 240 Volt O/S 1800 Watts	11050-25
Element 36 Oven 240 Volt I/S 1200 Watts	11050-26
Element 36 Oven 480 Volt O/S 1800 Watts	11050-29
Element 36 Oven 480 Volt I/S 1200 Watts	11050-30
Element 36 Oven 208 Volt O/S 1800 Watts	11050-31
Element 36 Oven 208 Volt I/S 1200 Watts	11050-32
Element 36 Oven 380 Volt O/S 1800 Watts	11050-33
Element 36 Oven 380 Volt I/S 1200 Watts	11050-34
Element Speed Unit 208 Volt 2100 Watts (Before C-42132)	11120-01
Element Speed Unit 240 Volt 2100 Watts (Before C-42132)	11120-02
Element Speed Unit 480 Volt 2100 Watts (Before C-35145)	11120-10
Element French Plate 208 Volt 2600 Watts (After C-42133)	11120-12
Element French Plate 240 Volt 2600 Watts (After C-42133)	11120-13
Element French Plate 480 Volt 2600 Watts (After C-35145)	11120-14
Speed Unit Bowl 208/240 Volt (Before C-42132)	11120-15
Speed Unit Spider 208/240 Volt (Before C-42132)	11120-16
Element French Plate 380 Volt 2000 Watts	11120-18
Speed Unit Ring 208/240 Volt (Before C-42132)	11120-19
Speed Unit Bowl/Ring Assembly 480 Volt (Before C-35145)	11120-20
Switch Rotating 3 Heat	2E-30304-35
Switch Rotating 6 Heat + Off (After C-35145)	30304-09
Switch Infinite Control (Before C-35145)	30305-01
Thermostat 450°F Oven/Griddle	30402-08
Thermostat 550°F Oven	30402-09
Thermostat 800°F Hot Top (Before C-35145)	30402-10
Thermostat 850°F Hot Top (After C-35145)	30402-23
Terminal Block 3 Pole	30500-07
Contactors 2 Pole 208/240 VAC (Before C-35145)	30701-02
Timer Mechanical Long Ring (380 Volt Units Only)	30801-01
Fuse 30 Amp 480 Volt Units (Before C-42132)	30900-06
Fuse 50 Amp 208/240 Volt Units (Before C-42132)	30900-09
Fuse Block 2 Pole 30 Amp 480 Volt Units (Before C-42132)	30901-05
Fuse Block 2 Pole 60 Amp 208/240 Volt Units (Before C-42132)	30901-06
Transformer 480/240 VAC (Before C-42132)	31400-04
Pilot Light 208/240V 6" Lead Black Body	31601-01
Pilot Light 480V 6" Lead Black Body	31601-02
Circuit Breaker 208/240 Volt 1 Pole	31800-02
Element Pan Assembly w/ Snout	50300-20
Speed Unit Frame Assembly (Before C-42132)	50300-29
French Plate Frame Assembly (After C-35145)	50300-82
Element Clip Long	50301-09

PARTS LIST

500S Standard Bake Oven Range

DESCRIPTION	PART NO.
Element Clip Short	50301-10
Element Bushing Metal	50301-11
Hot Top Assembly 3/4" x 1ft (Before D-83889)	50400-02
Range Plate Assembly 1/2" x 1ft	50401-01
Range Plate Assembly 1/2" x 2ft	50401-02
Range Plate Assembly 1/2" x 3ft	50401-03
Tension Disc Oven Door	50800-07
Spring Left Side 7 1/2" Long – Oven Door	51001-01
Spring Right Side 7 1/2" Long – Oven Door	51001-02
Grease Drawer	60102-292
Handle Assembly Oven Door	70603-05
Knob Infinite Control (Before C-35145)	70701-04
Knob Manual Timer (380 Volt Units Only)	70701-09
Knob 3 Heat Switch	70701-10
Knob Thermostat 550°F Oven	70701-12
Knob Thermostat 450°F Griddle/Oven	70701-16
Knob Thermostat 800°F Hot Top (Before C-35145)	70701-20
Knob Damper Black (380 Volt Units Only)	70701-25
Knob Thermostat 850°F Hot Top (After C-35145)	70701-35
Knob 6 Heat Switch (After C-35145)	70701-41

WIRING DIAGRAM 208/240 VOLT

MODEL DESIGNATION		TOP ARRANGEMENT				
		SECTION 1	SECTION 2	SECTION 3	SECTION 4	SECTION 5
500S-A	*500S-ACT	B	B	B	B	B
500S-B	*500S-BCT	B	B	B	B	C
500S-C	*500S-CCT	A	A	B	B	C
500S-D	*500S-DCT	A	A	A	B	C
500S-E	*500S-ECT	A	A	A	A	A
500S-F	*500S-FCT	A	A	A	A	C
500S-G	*500S-GCT	A	A	A	A	A

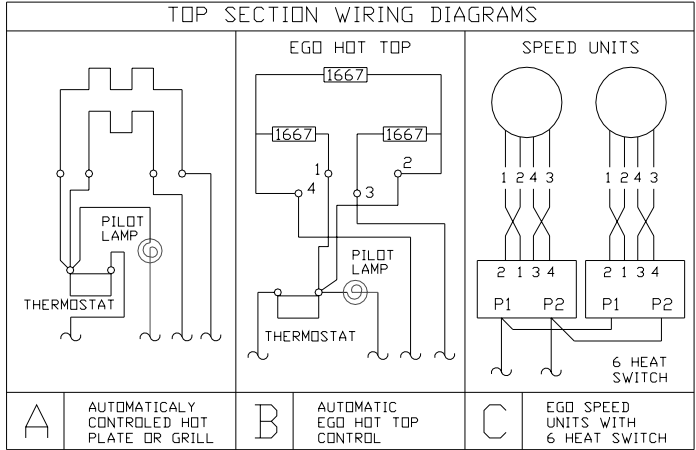
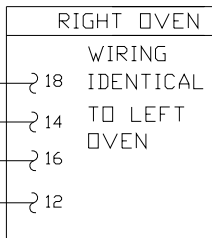
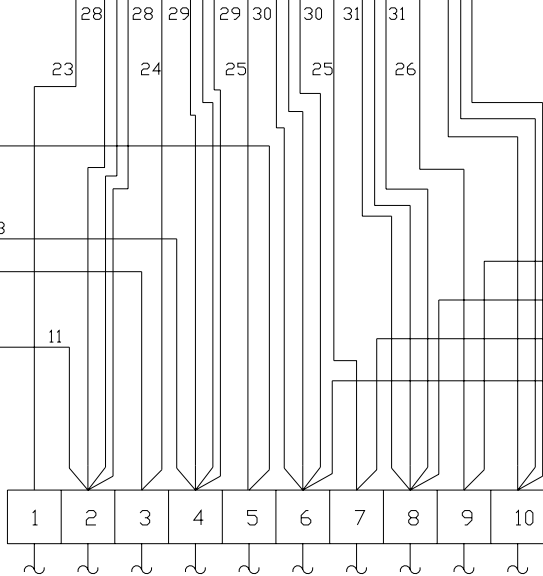
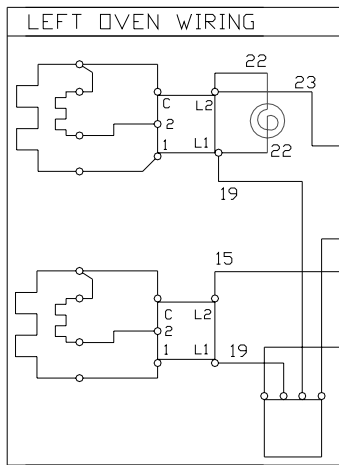

SERVICE CONNECTION		
SINGLE PHASE	L1	1,3,5,7,9
	L2	2,4,6,8,10
THREE PHASE	L1	1,4,7,10
	L2	2,5,8
	L3	3,6,9

KW PER PHASE - RANGE		
L1-L2	L2-L3	L3-L1
13	11	13

KW PER PHASE - COOK TOP		
L1-L2	L2-L3	L3-L1
10	5	10

- NOTES:
- EXAMPLE FOR DETERMINING THE WIRING OF A LANG RANGE
 1.1 VIEWED FROM THE FRONT, LEFT TO RIGHT, THE TOP 1 FOOT SECTIONAL ARRANGEMENT FOR THE 500S-C RANGE IS A,A,B,C (AS DETERMINED BY THE TOP ARRANGEMENT CHART) EACH OF THE LETTERS REPRESENT ONE OF THE TYPICAL WIRING DIAGRAMS SHOWN ABOVE.
 - THE POWER INPUT LEADS TO EACH TOP SECTION AND THE OVEN ARE SHOWN IN THE DIAGRAM AT THE LEFT CONNECTED TO THEIR RESPECTIVE CIRCUIT BREAKERS.
 - PROPER RANGE PHASING AND POWER DISTRIBUTION TO EACH CIRCUIT MAY BE DETERMINED BY REFERRING TO THE SERVICE CONNECTION CHART.
 - COOK TOP ONLY - DELETE OVEN CIRCUITS

500S RANGE WITH EGO HOT TOPS
 USE ON (E) SERIAL NO. AND ON

RANGE TOP WIRING

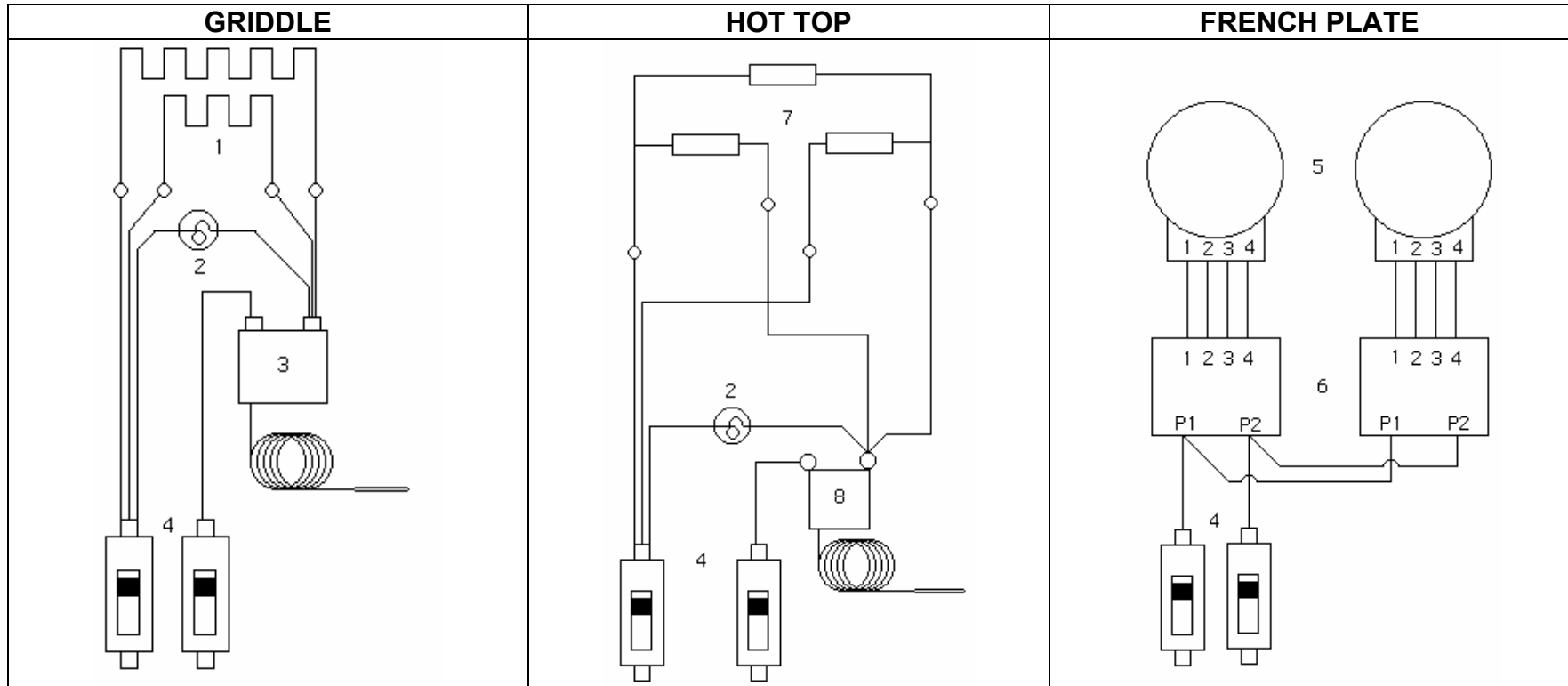

1. Griddle and Top Plate Element
2. Pilot Light
3. 450° Griddle thermostat
4. Circuit breakers
5. French plate
6. 6-Heat switch
7. Hot Top
8. 800° Hot Top thermostat.

WIRING DIAGRAM 480 VOLT

MODEL	TOP ARRANGEMENT				
	SECTION 1	SECTION 2	SECTION 3	SECTION 4	SECTION 5
500S-A	B	B	B	B	B
500S-B	B	B	B	B	C
500S-C	A	A	B	B	C
500S-D	A	A	A	B	C
500S-E	A	A	A	A	B
500S-F	A	A	A	A	C
500S-G	A	A	A	A	A

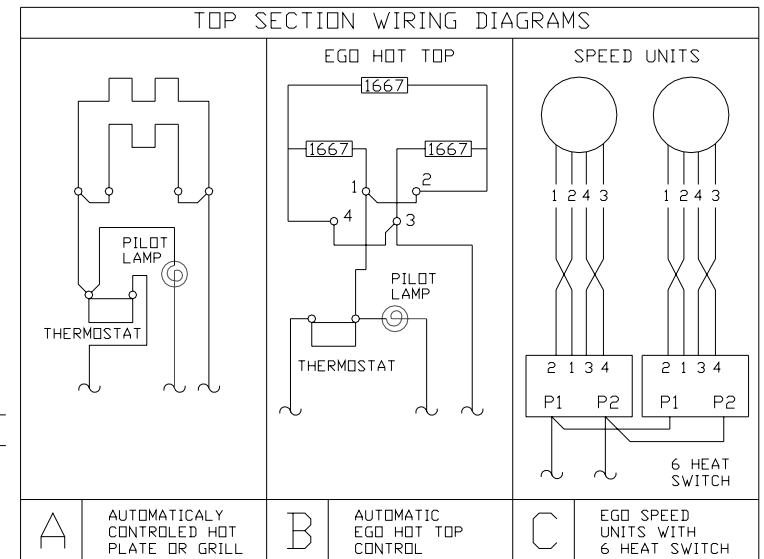
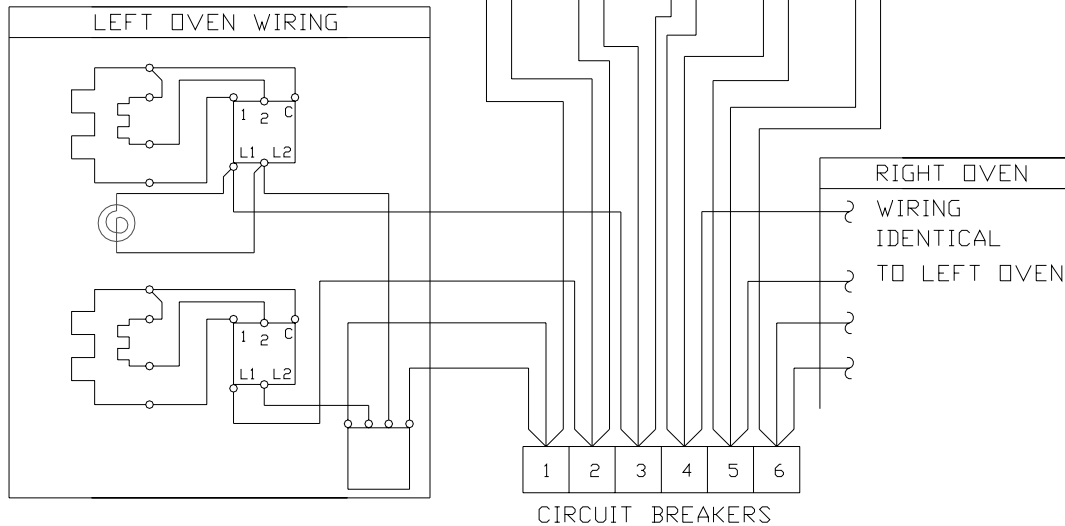

SERVICE CONNECTION		
THREE PHASE	L1	1,4
	L2	2,5
	L3	3,6
KW PER PHASE	L1-L2	13
	L2-L3	13
	L3-L1	11

NOTES:

- EXAMPLE FOR DETERMINING THE WIRING OF A LANG RANGE
 1.1 VIEWED FROM THE FRONT, LEFT TO RIGHT, THE TOP 1 FOOT SECTIONAL ARRANGEMENT FOR THE 500S-C RANGE IS A,A,B,B,C (AS DETERMINED BY THE TOP ARRANGEMENT CHART) EACH OF THE LETTERS REPRESENT ONE OF THE TYPICAL WIRING DIAGRAMS SHOWN ABOVE.
- THE POWER INPUT LEADS TO EACH TOP SECTION AND THE OVEN ARE SHOWN IN THE DIAGRAM AT THE LEFT CONNECTED TO THEIR RESPECTIVE CIRCUIT BREAKERS.
- PROPER RANGE PHASING AND POWER DISTRIBUTION TO EACH CIRCUIT MAY BE DETERMINED BY REFERRING TO THE SERVICE CONNECTION CHART.

**Lang Manufacturing Limited Warranty
to Commercial Purchasers*
(Domestic U.S., Hawaii, &
Canadian Sales only.)**

Lang Manufacturing Equipment (“Lang Equipment”) has been skillfully manufactured, carefully inspected and packaged to meet rigid standards of excellence. Lang warrants its Equipment to be free from defects in material and workmanship for (12) twelve consecutive months, with the following conditions and subject to the following limitations.

I. This parts and labor warranty is limited to Lang Equipment sold to the original commercial purchaser/users (but not original equipment manufacturers), at its original place of installation, in the continental United States, Hawaii and Canada.

Quartz elements are warranted for ninety(90) days from the date of installation.

II. Damage during shipment is to be reported to the carrier, is not covered under this warranty, and is the sole responsibility of purchaser/user.

III. Lang, or an authorized service representative, will repair or replace, at Lang’s sole election, and Lang Equipment, including but not limited to, safety valves, gas and electric components, found to be defective during the warranty period. As to warranty service in the territory described above, Lang will absorb labor and portal to portal transportation costs (time & mileage) for the first (12) twelve months from the date of installation or eighteen (18) months from date of shipment from Lang Manufacturing, which ever comes first.

IV. This warranty does not cover routine general maintenance, periodic adjustments, as specified in operating instructions or manuals, and consumable parts such as quartz elements, or labor costs incurred for removal of adjacent equipment or objects to gain access to Lang Equipment. This warranty does not cover defects caused by improper installation, abuse, careless operation, or improper maintenance of equipment.

V. THIS WARRANTY IS EXCLUSIVE AND IS IN LIEU OF ALL OTHER WARRANTIES, EXPRESSED OR IMPLIED, INCLUDING ANY IMPLIED WARRANTY OF MERCHANTABILITY OR FITNESS FOR A PARTICULAR PURPOSE, EACH OF WHICH IS HEREBY EXPRESSLY DISCLAIMED. THE REMEDIES DESCRIBED ABOVE ARE EXCLUSIVE AND IN NO EVENT SHALL LANG BE LIABLE FOR SPECIAL, CONSEQUENTIAL OR INCIDENTAL DAMAGES FOR THE BREACH OR DELAY IN PERFORMANCE OF THIS WARRANTY.

VI. Lang Equipment is for commercial use only. If sold as a component of another(OEM) manufacturer’s equipment, or if used as a consumer product, such Equipment is sold AS IS and without any warranty.