







Installation, Operation, Maintenance and Service Instructions

Model: GCOF-PP-NAT

THIS MANUAL MUST BE RETAINED FOR FUTURE REFERENCE. READ, UNDERSTAND AND FOLLOW THE INSTRUCTIONS AND WARNINGS CONTAINED IN THIS MANUAL.

- | | | |
|---------------|---|---|
| DANGER | POTENTIALLY HAZARDOUS SITUATION, WHICH, IF NOT AVOIDED, COULD RESULT IN DEATH. |  |
|---------------|---|---|
- | | | |
|----------------|---|---|
| WARNING | POTENTIALLY HAZARDOUS SITUATION, WHICH, IF NOT AVOIDED, COULD RESULT IN DEATH OR SERIOUS INJURY. |  |
|----------------|---|---|
- | | | |
|----------------|---|---|
| CAUTION | POTENTIALLY HAZARDOUS SITUATION WHICH, IF NOT AVOIDED, MAY RESULT IN MINOR OR MODERATE INJURY. |  |
|----------------|---|---|
- | | | |
|---------------|---|---|
| NOTICE | Helpful operation and installation instructions and tips are present. |  |
|---------------|---|---|

FOR YOUR SAFETY

DO NOT STORE OR USE GASOLINE OR OTHER FLAMMABLE VAPORS AND LIQUIDS IN THE VICINITY OF THIS OR ANY OTHER APPLIANCE.

POST IN A PROMINENT LOCATION













INSTRUCTIONS TO BE FOLLOWED IN THE EVENT USER SMELLS GAS. THIS INFORMATION SHALL BE OBTAINED BY CONSULTING YOUR LOCAL GAS SUPPLIER. AS A MINIMUM, TURN OFF THE GAS AND CALL YOUR GAS COMPANY AND YOUR AUTHORIZED SERVICE AGENT. EVACUATE ALL PERSONNEL FROM THE AREA.

WARNING: IMPROPER INSTALLATION, ADJUSTMENT, ALTERATION, SERVICE OR MAINTENANCE CAN CAUSE PROPERTY DAMAGE, INJURY OR DEATH. READ THE INSTALLATION, OPERATING AND MAINTENANCE INSTRUCTIONS THOROUGHLY BEFORE INSTALLING OR SERVICING THIS EQUIPMENT.

Model #:	Purchased From:
Serial #:	Location:
Date Purchased:	Date Installed:
Purchase Order #:	For Service, Call:

Table of Contents

Chapter	Page
Table Of Contents	3
Read First.....	4
Equipment Description	6
Unpacking	7
Installation	8
Initial Start-Up	13
Operation	14
Maintenance & Cleaning Procedures.....	18
Troubleshooting	19
Parts List	21
Wiring Diagram	22

CAUTION	THE OVEN WEIGHS 500 LBS. FOR SAFE HANDLING, INSTALLER SHOULD OBTAIN HELP AS NEEDED, OR EMPLOY APPROPRIATE MATERIALS HANDLING EQUIPMENT (SUCH AS A FORKLIFT, DOLLY, OR PALLET JACK) TO REMOVE THE UNIT FROM THE SKID AND MOVE IT TO THE PLACE OF INSTALLATION.	
CAUTION	ANY STAND, COUNTER OR OTHER DEVICE ON WHICH THE OVEN WILL BE LOCATED MUST BE DESIGNED TO SUPPORT THE WEIGHT OF THE OVEN.	
CAUTION	SHIPPING STRAPS ARE UNDER TENSION AND CAN SNAP BACK WHEN CUT.	
WARNING	INSTALLATION OF THE UNIT MUST BE DONE BY PERSONNEL QUALIFIED TO WORK WITH PLUMBING. IMPROPER INSTALLATION CAN CAUSE INJURY TO PERSONNEL AND/OR DAMAGE TO EQUIPMENT. UNIT MUST BE INSTALLED IN ACCORDANCE WITH ALL APPLICABLE CODES.	
NOTICE	The data plate is located above control panel behind wire mesh screen. The oven serial number, gas specifications, and clearance specifications are on the data plate. This information should be carefully read and understood before proceeding with the installation.	
NOTICE	The installation of any components such as a vent hood, grease extractors, fire extinguisher systems, must conform to their applicable National, State and locally recognized installation standards.	
WARNING	THIS APPLIANCE IS EQUIPPED WITH A 3-PRONG (GROUNDING) PLUG FOR YOUR PROTECTION AGAINST SHOCK HAZARD AND MUST BE PLUGGED DIRECTLY INTO A PROPERLY GROUNDED 3-PRONG RECEPTACLE. DO NOT CUT OR REMOVE THIS GROUNDING PRONG FROM THE PLUG.	
WARNING	CONVECTION OVENS INSTALLED WITH CASTERS MUST HAVE THE FOLLOWING: A CONNECTOR THAT COMPLIES WITH THE STANDARD FOR CONNECTORS FOR MOVABLE GAS APPLIANCES ANSI Z21.69 LATEST EDITION, A QUICK DISCONNECT THAT COMPLIES WITH THE STANDARD FOR QUICK DISCONNECT DEVICES FOR USE WITH GAS FUEL, ANSI Z21.141 LATEST EDITION, A TETHER OR OTHER MEANS TO LIMIT APPLIANCE MOVEMENT WITH OUT RELIANCE ON THE GAS SUPPLY PIPING. SECURELY ATTACH THE TETHER TO THE EYEBOLT PROVIDED AT THE REAR OF THE APPLIANCE.	
NOTICE	Kits designed to accommodate ovens from sea level to 5000 feet. Contact factory for orifice sizes on installations above 5000 feet.	
WARNING	BEFORE LIGHTING, USE A SOAP AND WATER SOLUTION TO TEST ALL JOINTS FOR GAS LEAKS.	
NOTICE	During the first few hours of operation, you may notice a small amount of smoke coming off the oven, and a faint odor from the smoke. This is normal for a new oven and will disappear after the first few hours of use.	
CAUTION	ALWAYS KEEP THE AREA NEAR THE APPLIANCE FREE FROM COMBUSTIBLE MATERIALS.	

CAUTION

KEEP FLOOR IN FRONT OF EQUIPMENT CLEAN AND DRY. IF SPILLS OCCUR, CLEAN IMMEDIATELY, TO AVOID THE DANGER OF SLIPS OR FALLS.

**WARNING**

KEEP WATER AND SOLUTIONS OUT OF CONTROLS. NEVER SPRAY OR HOSE CONTROL CONSOLE.

**CAUTION**

MOST CLEANERS ARE HARMFUL TO THE SKIN, EYES, MUCOUS MEMBRANES AND CLOTHING. PRECAUTIONS SHOULD BE TAKEN TO WEAR RUBBER GLOVES, GOGGLES OR FACE SHIELD AND PROTECTIVE CLOTHING. CAREFULLY READ THE WARNING AND FOLLOW THE DIRECTIONS ON THE LABEL OF THE CLEANER TO BE USED.

**NOTICE**

Never leave a chlorine sanitizer in contact with stainless steel surfaces longer than 10 minutes. Longer contact can cause corrosion.

**NOTICE**

Service on this or any other Lang appliance must be performed by qualified personnel only. Consult your Lang Authorized Service Agent Directory. You can call our toll free number 1-800-807-9054 or visit our website WWW.STAR-MFG.COM for the service agent nearest you.

**WARNING**

BOTH HIGH AND LOW VOLTAGES ARE PRESENT INSIDE THIS APPLIANCE WHEN THE UNIT IS PLUGGED/WIRED INTO A LIVE RECEPTACLE. BEFORE REPLACING ANY PARTS, DISCONNECT THE UNIT FROM THE ELECTRIC POWER SUPPLY.

**CAUTION**

USE OF ANY REPLACEMENT PARTS OTHER THAN THOSE SUPPLIED BY STAR OR THEIR AUTHORIZED DISTRIBUTORS CAN CAUSE BODILY INJURY TO THE OPERATOR AND DAMAGE TO THE EQUIPMENT AND WILL VOID ALL WARRANTIES.

**IMPORTANT**

The installation of the Appliance should conform to the NATIONAL FUEL GAS CODE "ANSI Z223.1/NFPA 54 - LATEST EDITION" AND ALL LOCAL GAS COMPANY RULES AND REGULATIONS.

IN CANADA INSTALLATION SHALL BE IN ACCORDANCE WITH THE CURRENT CAN/CGA-B149.1 NATURAL GAS INSTALLATION CODE OR CAN/CGA-B149.2 PROPANE INSTALLATION CODE AND LOCAL CODES WHERE APPLICABLE.

Equipment Description

Lang Model: GCOF-PPNATFD

Exterior Construction

The oven exterior dimensions are 40" (100 cm) Wide, 32" (80 cm) High, 38" (95 cm) Deep. The Top, Front, Back, and Sides are constructed of stainless steel with an aluminized bottom.

The oven doors come standard with a double pane window.

The door handle is constructed of Stainless Steel and Phenolic Tubing.

The oven cavity is insulated with high temperature insulation for efficiency and reduced heat loss.

Interior Construction

The oven cavity dimensions are 29" (72.5 cm) Wide, 20" (50.84 cm) High, 21" (53.38 cm) Deep.

The interior of the oven is constructed of porcelainized stainless steel.

Operation

The GCOF-PPNATFD oven is a forced air convection oven with a vented oven cavity.

The air is driven by a 1/3 HP fan motor.

Controls

Complete computerized controls.

Pre-Programmable product selections.

Independent shelf timers for each shelf.

Load control through use of Cooking Curves.

Shelf compensation for uniform baking.

Solid state temperature sensing and controls.

Dual speed fan.

Manual override controls.

Technical

The GCOF-PPNATFD oven operates on either Natural Gas or Propane and can be field converted to either gas.

Floor space required is 48" (122.6 cm) wide, 44" (112.5 cm) deep.

The oven weighs 500 lbs. (227.28 kg).

Contact the factory for correct orifice sizes when installing oven above 4000ft.

The GCOF-PPNATFD has electronic ignition and requires a 120-Volt single-phase connection.

Receiving the Oven



Upon receipt, check for freight damage, both visible and concealed. Visible damage should be noted on the freight bill at the time of delivery and signed by the carrier's agent. Concealed loss or damage means loss or damage, which does not become apparent until the merchandise has been unpacked. If concealed loss or damage is discovered upon unpacking, make a written request for inspection by the carrier's agent within 15 days of delivery. All packing material should be kept for inspection. **Do not return damaged merchandise to Star Manufacturing Company. File your claim with the carrier.**

Location

Prior to un-crating, move the oven as near to its intended location as practical. The crating will help protect the unit from the physical damage normally associated with moving it through hallways and doorways.

Un-crating

The oven will arrive completely assembled inside a wood frame and strapped to a skid. **Cut the straps and remove the wood frame.**

CAUTION	THE OVEN WEIGHS 500 LBS. FOR SAFE HANDLING, INSTALLER SHOULD OBTAIN HELP AS NEEDED, OR EMPLOY APPROPRIATE MATERIALS HANDLING EQUIPMENT (SUCH AS A FORKLIFT, DOLLY, OR PALLET JACK) TO REMOVE THE UNIT FROM THE SKID AND MOVE IT TO THE PLACE OF INSTALLATION.	
CAUTION	ANY STAND, COUNTER OR OTHER DEVICE ON WHICH THE OVEN WILL BE LOCATED MUST BE DESIGNED TO SUPPORT THE WEIGHT OF THE OVEN.	
CAUTION	SHIPPING STRAPS ARE UNDER TENSION AND CAN SNAP BACK WHEN CUT.	

Remove oven from skid and place in intended location.

WARNING **INSTALLATION OF THE UNIT MUST BE DONE BY PERSONNEL QUALIFIED TO WORK WITH PLUMBING. IMPROPER INSTALLATION CAN CAUSE INJURY TO PERSONNEL AND/OR DAMAGE TO EQUIPMENT. UNIT MUST BE INSTALLED IN ACCORDANCE WITH ALL APPLICABLE CODES.**



NOTICE The data plate is located above control panel behind wire mesh screen. The oven serial number, gas specifications, and clearance specifications are on the data plate. This information should be carefully read and understood before proceeding with the installation.



NOTICE The installation of any components such as a vent hood, grease extractors, fire extinguisher systems, must conform to their applicable National, State and locally recognized installation standards.



Leg Installation

Legs are available for both the single and double deck installations. Single deck installations require a 27-inch leg. Double deck installations require 6-inch legs or casters.

To install the 27-inch legs, place some cardboard on the floor and gently tip the oven onto its back. Fasten two legs to the oven's front corners using the four 5/16 inch bolts provided in the leg kit. Lift the oven onto its front legs and block the back up using one of the 27-inch legs set upside down in the center rear of the oven body. Install the last 27-inch leg onto the oven body on the control side rear. Gently lift the oven rear, remove the leg set to support the oven center and install it on the last rear corner.

To install the 6-inch legs or casters, follow the instructions in the Leg Pad section on the following pages or in the Leg Pad box supplied with the oven.

The adjustable feet on the bottom of each leg may be screwed in or out as necessary to level the oven.

A torpedo level placed on an oven rack will assist in leveling the oven.

Stacking the Ovens

Remove all the plug buttons from the top of the lower oven.

Remove the stacking kit from the oven compartment of one oven and install the 1 1/4-inch plastic bushing into the top of the lower oven.

Tip the top oven backwards and install two 3/8-inch socket head bolts, found in the stacking kit, into the two front leg holes that match the holes in the top of the lower oven. Install the socket head bolts with the heads of the bolt pointing away from the oven.

Lift the top oven and gently set on top of the lower oven so that the heads of the socket head bolts nest into the holes in the top of the lower oven.

Installation cont'd

Leg Pad Adapter

Identify the front and rear leg adapters (the front adapters have two threaded inserts, the rear has four).

Leg to Adapter Installation:

Install the leg's threaded stud through the hole in the adapter labeled "C" with the bent flange of the adapter facing away from the leg.

Screw the 3/4-inch nut supplied in the adapter kit onto the leg stud and tighten.

Caster to Adapter Installation:

Place the swivel caster against the front leg adapter with the flange of the adapter facing away from the caster.

Install the four 5/16 inch bolts through the caster base and the adapter holes labeled "A" then install the 5/16 inch nuts with washer and lock washers.

Place the rigid casters against the rear leg adapter with the flange of the adapter facing away from the caster.

Align the caster to the holes in the adapter labeled "B". NOTE: There are two sets of "B" holes set at 90° from the each other. One set will create a left rear adapter and the other set will create a right rear adapter.

Install four 5/16-inch bolts through the caster base and the adapter holes labeled "B" then install 5/16-inch nuts with lock washers and flat washers.

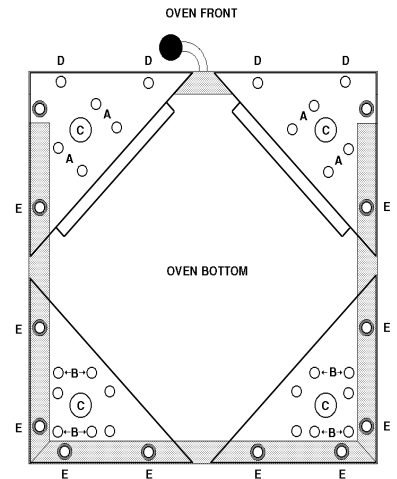

Adapter to Oven Installation:

Gently tip the oven onto its back. Place the front leg adapter into the front corners of the oven. The holes without the threaded inserts face the front of the oven and the flange on the adapter points toward the bottom of the oven.

The edge of the leg adapter with the threaded insert slips under the flange on the oven side, while the edge without the inserts sits on top of the threaded angle on the oven front.

Install two 3/8-inch bolts with lock washers and flat washers through the front holes "D" in the leg adapter and into the threaded inserts on the oven.

Thread one 3/8-inch bolt with lock washer and flat washer into the rear threaded hole labeled "E" on each of the leg adapters.

The forward threaded hole on the front leg adapter does not get a bolt installed.

Place the rear leg adapters into the rear corners of the oven so that the adapter is under the flange of the oven side and back. NOTE: If installing a caster place the adapter on the oven so that the casters roll forward.

Install for 3/8-inch bolts with lock washers and flat washers through the holes labeled "E" in the flange of the oven and into the threaded inserts of the leg adapter.

Ventilation and Clearances

Standard minimum clearance from combustible construction is as follows.

- 4" from side
- 4" from back
- 6" from floor

These ovens may be set directly, without legs, on a curbed base or **non-combustible** floor.

If the oven is set without legs on a **non-combustible** floor or a curbed base, maintain a 4-inch back clearance.

If the oven is set directly against a **non-combustible** back wall, maintain a 6-inch clearance to the floor.

Do not install the oven closer than 4 inches from another oven on the right hand side (control panel side).

Do not install the oven closer than 12 inches from an uncontrolled heat source (char broiler etc.) on the right side.

Keep the appliance area free and clear of combustible material and do not obstruct the flow of combustion or ventilation air.

The installation of any components such as a vent hood, grease extractors, and/or fire extinguisher systems, must conform to the there applicable nationally recognized installation standards.

WARNING THIS APPLIANCE IS EQUIPPED WITH A 3-PRONG (GROUNDING) PLUG FOR YOUR PROTECTION AGAINST SHOCK HAZARD AND MUST BE PLUGGED DIRECTLY INTO A PROPERLY GROUNDED 3-PRONG RECEPTACLE. DO NOT CUT OR REMOVE THIS GROUNDING PRONG FROM THE PLUG.



Electrical Connection

The electrical connection must be made in accordance with local codes or in the absence of local codes with NFPA No. 70 latest edition (in Canada use: CAS STD. C22.1).

The electrical service entrance is provided by a cord and plug located at the oven back directly behind the control compartment.

Each oven requires a 115-volt grounded supply and 7.1 amps.

Supply wire size must be large enough to carry the amperage load for the number of ovens being installed. Wire size information can be found on the oven data plate.

WARNING CONVECTION OVENS INSTALLED WITH CASTERS MUST HAVE THE FOLLOWING: A CONNECTOR THAT COMPLIES WITH THE STANDARD FOR CONNECTORS FOR MOVABLE GAS APPLIANCES ANSI Z21.69 LATEST EDITION, A QUICK DISCONNECT THAT COMPLIES WITH THE STANDARD FOR QUICK DISCONNECT DEVICES FOR USE WITH GAS FUEL, ANSI Z21.141 LATEST EDITION, A TETHER OR OTHER MEANS TO LIMIT APPLIANCE MOVEMENT WITH OUT RELIANCE ON THE GAS SUPPLY PIPING. SECURELY ATTACH THE TETHER TO THE EYEBOLT PROVIDED AT THE REAR OF THE APPLIANCE.



Gas Connection

This appliance is manufactured for use with the type of gas indicated on the data plate. Contact the factory if the gas type does not match that which is on the data plate.

All gas connections must be in accordance with local codes and comply with the National Fuel Gas Code ANSI Z223.1 latest edition.

An internal gas pressure regulator is located inside the control compartment.

Gas must be delivered to the appliance regulator at less than 1/2 pound of pressure and less than 1/2-inch water column pressure drop.

The internal regulator is preset at the factory, however, due to gas pressure variations from area to area, adjust the regulator to provide the manifold pressure indicated on the data plate. This should be 5 inches water column for natural gas and 10 inch water column for propane. A 1/8-inch NPT tap is provided on the main manifold for checking regulator pressure. Access the main manifold by removing the trim piece below the oven doors.

When replacing the 1/8-inch plug in the main manifold a joint sealant that is resistant to the action of liquid petroleum gas must be used.

The supply piping must be of sufficient size to provide 55,000 BTU/hr per oven. A 1/2-inch NPT connection is provided at the rear of the oven directly behind the control compartment. Connect each oven separately.

A gas shut off valve must be installed to the oven(s) and located in an accessible area.

This appliance and its individual shutoff valve must be disconnected from the gas supply piping system during any pressure testing of that system at test pressures in excess of 1/2 PSIG and the appliance must be isolated from the gas supply piping system by closing its individual manual shutoff valve during any pressure testing of the gas supply system at test pressures equal to or less than 1/2 PSIG.

Test for gas leaks. Use a commercial leak detector or a soap and water solution.

Flu Installation

A flu extension must be installed on the lower oven of a stacked set.

The extension attaches to the flu opening of the lower oven and directs the flu products into the flu opening of the upper oven.

This extension must be installed.

The ovens may now be set into position. Be careful if sliding the ovens, they are not designed to slide over cracks or obstructions in the floor.

Installation cont'd

Gas Conversions

1. Disconnect oven from power and gas.
2. Remove bottom trim piece from oven (2 hex head bolts and 1 Phillips screw).
3. Remove side panel from oven.
4. Disconnect black manifold pipe from 3/8" aluminum pipe at the furrel nut.
5. Remove two Phillips screws holding black manifold pipe to oven.
6. Remove black manifold pipe from oven.
7. Remove both burner orifices from manifold and replace with new orifices, making sure to apply pipe thread compound.
8. Remove two Phillips screws holding pilot assembly to oven.
9. Remove pilot assembly from oven.
10. Remove 1/4" aluminum pipe from pilot assembly.
11. Remove pilot orifice and replace with new pilot orifice.
12. Re-attach 1/4" aluminum pipe to pilot assembly.
13. Re-attach pilot assembly to oven.
14. Re-install black manifold assemblies to oven, making sure that the orifices go into the burner tubes.
15. Re-attach 3/8" aluminum pipe to black manifold assembly.
16. Remove the seal screw from the combination gas valve.
17. Remove the adjustment screw and spring from the combination valve.
18. Insert new spring into the valve and adjustment screw.
19. Re-connect oven to power and gas and check for leaks using a soap solution.
20. Adjust gas pressure to correct water column (5"NG, 10"LP).
21. Install new seal screw provided in kit and affix "Caution" sticker to the visible side of the combination valve.
22. Re-install bottom trim piece and side panel.

NG to LP

Part No.	Description	Qty.
Y9-80401-05	Pilot Orifice, Drilled .010	1
Y9-80400-14	Main Burner Orifice, Drilled #53	2
Y9-80505-11	Combination Gas Valve Spring, Includes: 1. Spring 2. Seal Screw 3. Caution Sticker	1

LP to NG

Part No.	Description	Qty.
Y9-80401-10	Pilot Orifice, Drilled .018	1
Y9-80400-13	Main Burner Orifice, Drilled #43	2
Y9-80505-16	Combination Gas Valve Spring, Includes: 1. Spring 2. Seal Screw 3. Caution Sticker	1

NOTICE

Kits designed to accommodate ovens from sea level to 5000 feet. Contact factory for orifice sizes on installations above 5000 feet.



Initial Start Up

WARNING BEFORE LIGHTING, USE A SOAP AND WATER SOLUTION TO TEST ALL JOINTS FOR GAS LEAKS.



Pre-Power On

After the oven is installed and connected to power & gas, prior to turning on, verify the following:

The doors open and close freely.

All racks are in the oven correctly.

All packing materials have been removed from the inside of the oven. All power and gas connections are tight

Power On

The pilot burner is electronically ignited. When the oven power switch is turned On the pilot will light.

There is a lockout safety feature on the spark ignition module. If, during the initial start-up, the pilot does not light within 30 seconds the module will turn off all gas to the pilot burner. To reset the spark module, turn Off the power switch for 10 seconds then turn the switch back On. This may need to be repeated several times during the initial start-up until gas is present at the pilot burner.

NOTICE

During the first few hours of operation you may notice a small amount of smoke coming off the oven, and a faint odor from the smoke. This is normal for a new oven and will disappear after the first few hours of use.



Control Panel

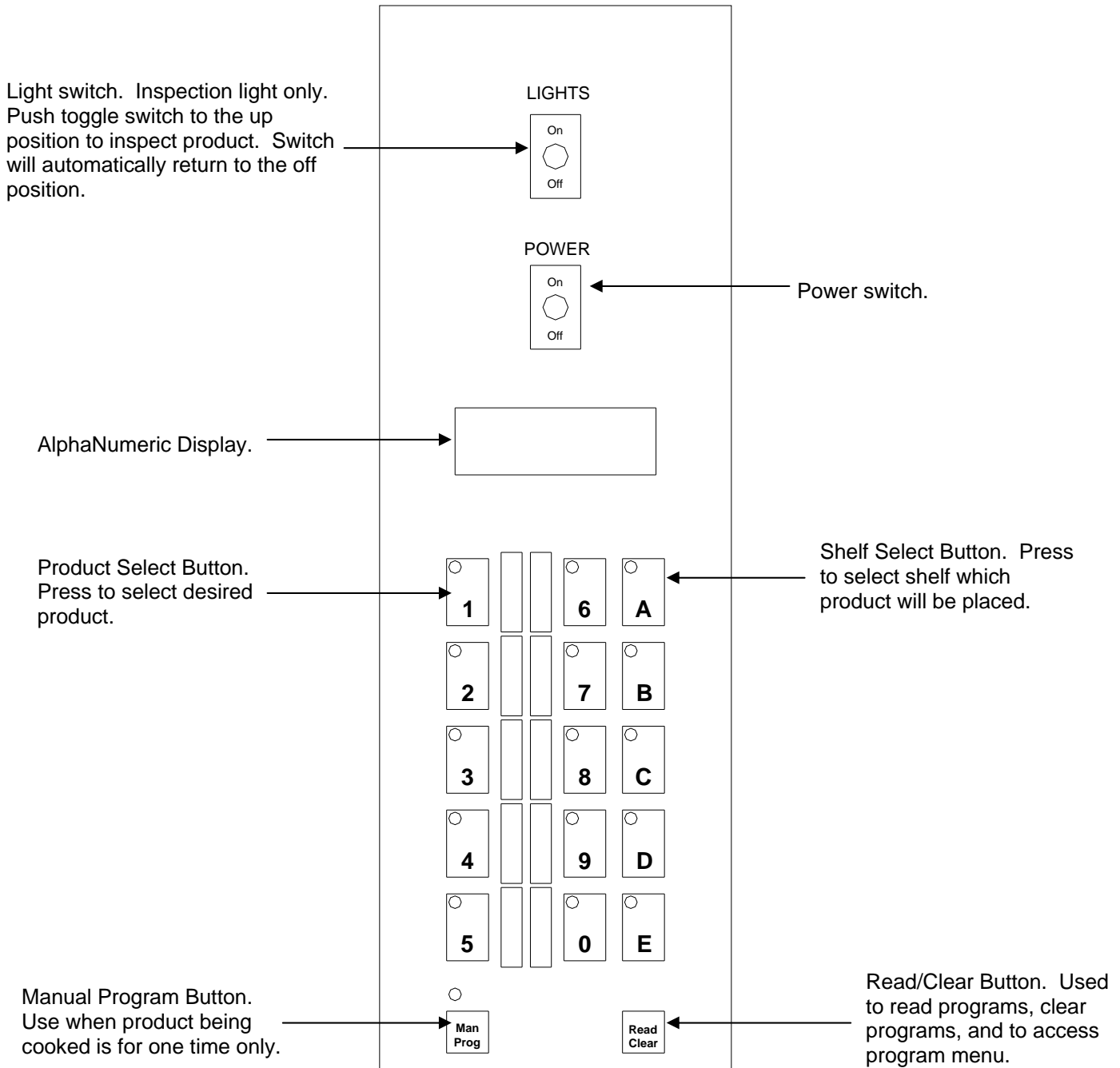

TYPICAL OPERATION SEQUENCE

ACTION	RESULT
Turn power switch to ON.	Control panel comes on, display says “SELECT PRODUCT OR READ/CLEAR TO PROGRAM.”
Press a product button.	Display says “PRODUCT X PREHEATING TO XXX F” . Motor starts and oven begins preheating to the programmed temperature.
<i>Beeper sounds briefly.</i>	Display says “READY SELECT PRODUCT TO START ” .
Open the oven doors and load the product. Close the door and press the product button again.	Beeper sounds briefly and display says “SELECT OVEN SHELVES PRODUCT X” .
Press the shelf button(s) which correspond to the shelf positions, which the product is loaded (A equals the top shelf and E equals the bottom shelf).	Display shows a countdown timer and begins to count toward zero.
<i>Beeper sounds continuously.</i>	Display shows “DONE PRESS SHELF BUTTON X, REMOVE PRODUCT” , shelf button(s) flash.
Press the flashing shelf button(s).	Beeper stops. Display shows “READY SELECT PRODUCT TO START” if no other shelves carry product or resume count down for shelves that still have product cooking.
Open oven door and remove the product, which corresponds to flashing shelf button(s).	

Hints & Suggestions

Convection ovens constantly circulate air over and around the product. This strips away the thin layer of moisture and cool air from around the product allowing heat to penetrate more quickly.

Cooking times can be shortened and cooking temperatures can be reduced.

To convert standard deck oven recipes, reduce the temperature 50°F and the time by 25%. Make minor adjustments as necessary.

The lower the oven temperature the more even the bake.

Always weigh your product. This will give you a more consistent size, color and quality.

Check the product near the end of the initial cooking cycle by turning on the oven light and looking through the oven door windows.

Do not open the oven doors during baking as this will change the baking characteristics of the oven and make it difficult to determine a final program.

If the product is overdone on the outside and underdone on the inside, reduce the baking temperature.

If the product is pulling away from the edge of the pan, the temperature is too high or the cooking time too long.

The convection is a mechanical piece of equipment. The same control settings will always give the same results. If the results vary, problems may be because of product preparation.

Loading

When loading and unloading the oven, stage products and racks so the oven doors are opened for the least amount of time.

Be sure that racks are level within the oven.

Bent or warped pans can greatly affect the evenness of the cook or bake.

If using baker's parchment, be sure the parchment does not blow over the product. This will create a uneven bake.

Load each shelf evenly. Spaces should be maintained equally between the pan and oven walls, front and back.

Do not overload pan's this will create a uneven bake.



For best baking results, load the oven from the center out during random loading.

CAUTION ALWAYS KEEP THE AREA NEAR THE APPLIANCE FREE FROM COMBUSTIBLE MATERIALS.

CAUTION KEEP FLOOR IN FRONT OF EQUIPMENT CLEAN AND DRY. IF SPILLS OCCUR, CLEAN IMMEDIATELY, TO AVOID THE DANGER OF SLIPS OR FALLS.



Maintenance & Cleaning

WARNING	KEEP WATER AND SOLUTIONS OUT OF CONTROLS. NEVER SPRAY OR HOSE CONTROL CONSOLE.	
CAUTION	MOST CLEANERS ARE HARMFUL TO THE SKIN, EYES, MUCOUS MEMBRANES AND CLOTHING. PRECAUTIONS SHOULD BE TAKEN TO WEAR RUBBER GLOVES, GOGGLES OR FACE SHIELD AND PROTECTIVE CLOTHING. CAREFULLY READ THE WARNING AND FOLLOW THE DIRECTIONS ON THE LABEL OF THE CLEANER TO BE USED.	
NOTICE	Never leave a chlorine sanitizer in contact with stainless steel surfaces longer than 10 minutes. Longer contact can cause corrosion.	

Cleaning

Always start with a cold oven.

The stainless exterior can easily be cleaned using stainless steel cleaner. Always follow the cleaner manufacturer's instructions when using any cleaner. Care should be taken to prevent caustic cleaning compounds from coming in contact with the blower wheel.

The oven racks, rack slides, and interior may be cleaned using oven cleaner. Discoloration or heat tint may be removed using a Carbon Release oven cleaner.

The oven interior should be cleaned using a mild soap and a non-metal scouring pad. **DO NOT use caustic cleaners.**

Always apply these cleaners when the oven is cold and rub in the direction of the metal's grain.

Troubleshooting

Symptoms

What follows is a chart of Symptoms and Possible Causes to aid in diagnosing faults with the oven.

Refer to the Symptoms column to locate the type of failure then to the Possible Cause for the items to be checked.

To test for a possible causes refer to the TEST section and locate the Possible Cause then refer to test to identify test procedures

Symptom	Possible Cause
Display will not come on.	No power to cord outlet Oven unplugged from outlet Failed power cord or plug Failed power switch Failed pilot ignition Contrast needs to be adjusted Failed display board
Oven will not heat	Power Switch is not "ON" No product selected Failed Pilot ignition Failed Circuit Board Failed Probe Failed Module Failed Centrifugal switch in Motor Failed Motor Failed Over-temperature Thermostat Failed Valve
Motor will not run	Power Switch is not "ON" No product selected Failed Pilot ignition Failed Motor Failed Contactor Failed Circuit Board
Product burning	Product is cooked too long Failed circuit board Failed probe
Product under done	Product is not cooking long enough Failed circuit board Failed probe

Troubleshooting cont'd

NOTICE

Service on this or any other Lang appliance must be performed by qualified personnel only. Consult your Lang Authorized Service Agent Directory. You can call our toll free number (314) 678-6315 or visit our website WWW.LANGWORLD.COM for the service agent nearest you.



WARNING

BOTH HIGH AND LOW VOLTAGES ARE PRESENT INSIDE THIS APPLIANCE WHEN THE UNIT IS PLUGGED/WIRED INTO A LIVE RECEPTACLE. BEFORE REPLACING ANY PARTS, DISCONNECT THE UNIT FROM THE ELECTRIC POWER SUPPLY.



TESTS

If an item on the list is followed by an asterisk (*), the work should be done by a factory authorized service representative.

Possible Cause	Test
Product is cooked too long	No test available, operational condition
Failed Probe	Check probe for proper resistance*
Failed Circuit Board	Confirm that board is getting correct voltage* Confirm that board is putting out correct voltage*
Failed Valve	Remove the wires and check for continuity across the coil*
Failed Centrifugal switch in Motor	Remove the wires and check for continuity across them while motor is turning*
Failed Motor contactor	Remove the wires from the contactor coil and check for continuity across the contactor coil connection* Ensure the contactor moveable points move freely up and down*
Failed Motor	Confirm that motor is getting correct voltage*
Failed or disconnected safety thermostat	Check across the thermostat connectors for continuity*
Failed Spark Module	Confirm that Spark Module is getting proper voltage*

CAUTION

USE OF ANY REPLACEMENT PARTS OTHER THAN THOSE SUPPLIED BY STAR OR THEIR AUTHORIZED DISTRIBUTORS CAN CAUSE BODILY INJURY TO THE OPERATOR AND DAMAGE TO THE EQUIPMENT AND WILL VOID ALL WARRANTIES.



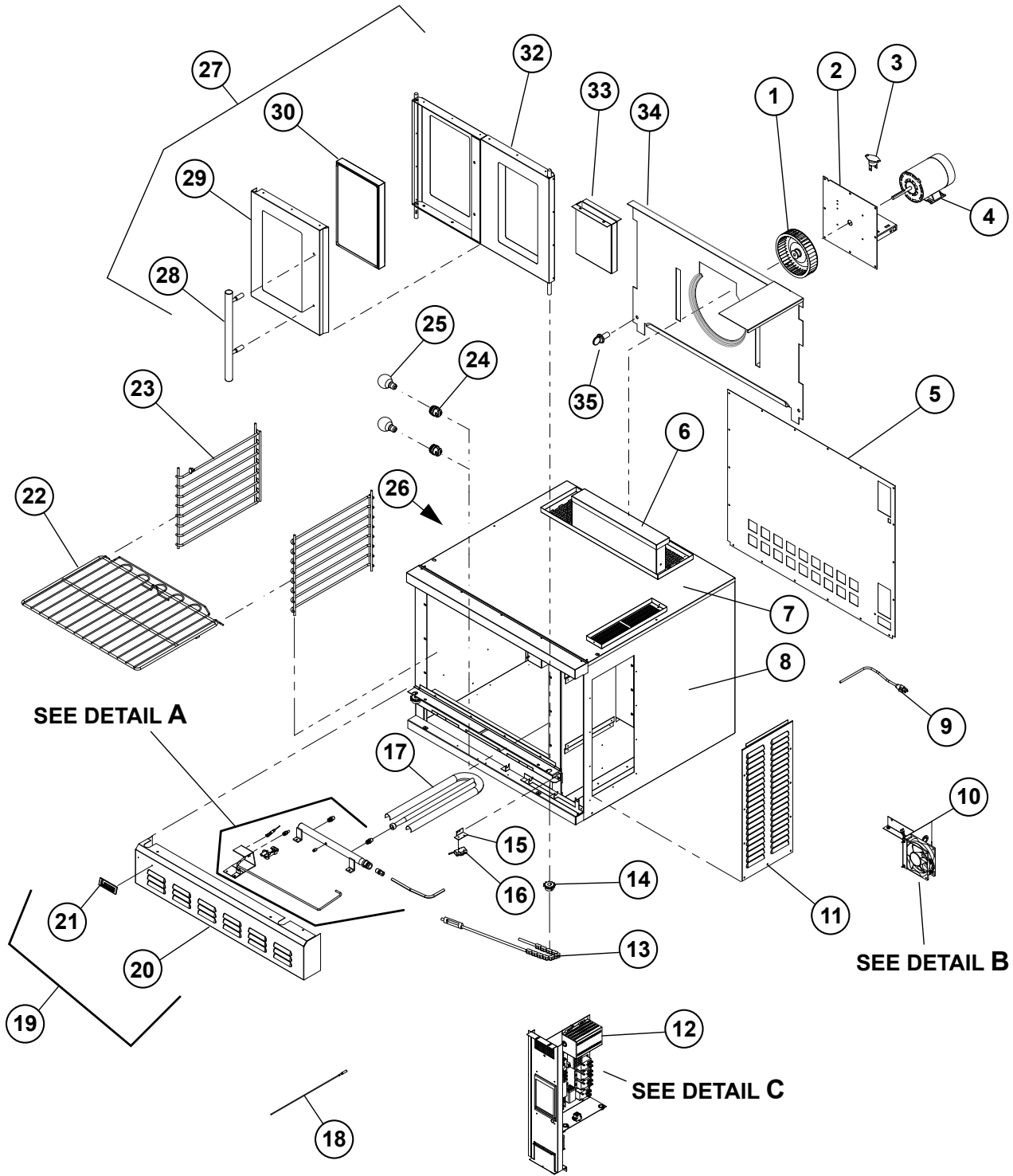

Model:
 GCOD/F-PP & GCOD/F-PT
 Gas Convection Oven

Lang[®]

SK2348 Rev. B 5/30/13

PARTS LIST

May 30, 2013 Rev A

Model No: GCOF-PPNATFD, GCOD-PT-NAT, GCOF-PT-NAT, GCOF-PTNATMF/CO
Commercial Full Size Gas Convection Oven

Key Number	Part Number	Qty Per	Description	
1	2U-71500-05	1	BLOWER WHEEL ECCO/GCCO	ALL
2	Q9-GCCO-164	1	MOTOR MOUNT WELD	ALL
3	2T-30401-09	1	STAT FXD 500 DEG OPEN	ALL
4	PS-30200-35	1	REPLACEMENT MOTOR	ALL
5	Q9-GCCO-181	1	BODY BACK	ALL
6	Q9-GCCO-264-1	1	FLUE DEFLECTOR SPOT	ALL
7	LM-GCCO-154	1	CAN TOP ASSY	GCOF
	Q9-60102-1403	1	GCCO TOP PANEL ASSY w/ MNT HRD	GCOD
8	Q9-60102-140	1	GCCO RIGHT SIDE S/S	GCOF
	Q9-60102-1402	1	GCCO RIGHT SIDE S/S EXTRA DEEP w/ MNT HRD	GCOD
9	2E-31107-02	1	CORD SET 14/3 X 8' 15A	ALL
10	Q9-60102-171		GCCO COOLING FAN KIT 120V	
	Q9-60102-1711		GCCO COOLING FAN KIT 220V	
11	Q9-60102-904	1	ACCESS COVER - ECCO/GCCO, & HRDWR	ALL
12	Q9-GCCOPPP	1	PANEL GCCO PURPLE PLUS	GCOF-PPNATFD
	Q9-GCCOPPT	1	PANEL GCCO PLATINUM	GCOD-PT-NAT, GCOF-PT-NAT, GCOF-PTNATMF
13	2A-50312-01	2	DOOR CHAIN	ALL
	Q9-50312-02	2	DOOR CHAIN AND TURNBCKL ASSY	ALL
14	2P-73000-03	1	SST SPRKT40B11 5/8 BORE	ALL
15	Q9-ECCO-145-1	1	MICRO SWITCH BRACKET	ALL
16	2E-30301-02	1	SWITCH, MICRO	ALL
17	Q9-GCCO-257-W1	2	BURNER WELD ASSY	ALL
18	2E-41100-08	1	SENSOR ECCO/GCCO TEMP	ALL
19	Q9-60102-115		BOTTOM PANEL WELD ASSY w/ LOGO	ALL
20	Q9-GCCO-233-2	1	BOTTOM PANEL ASSY	ALL
21	2M-60301-43	1	DIE CAST PLT LANG SATIN	ALL
22	2B-50200-20	5	RACK ECCO/GCCO OVEN	GCOF
	2B-50200-31	5	RACK ECO DEEP OVEN ONLY	GCOD
23	2B-50200-33	2	RACK SLIDE 5 POS ECO DEEP	GCOD
	2B-50200-93	2	RACK SLIDE 11 POS	GCOF
24	2E-31602-04	2	LAMP SKT SNAP-IN WHT	ALL
25	2S-31603-09	2	LAMPS INC 120V 40W	ALL
26	Q9-60102-137	1	BODY SIDE LH GCCO	GCOF
	M9-60102-14021	1	GCCO LEFT SIE S/S EXTRA DEEP w/ MNT HRD	GCOD
27	Q9-50312-44	1	LH DOOR ASSY E/GCCO	ALL
	Q9-50312-441	1	LH DOOR ASSY E/GCCO SOLID	GCOFSD
28	Y9-50312-05	1	HANDLE ASSY 1 HANDLE	ALL
29	Q9-50312-47	1	LH OUTER DOOR	ALL
30	2Q-71301-04	1	WINDOW ASSY 9-5/8X16-5/8	ALL
31	Q9-50312-54	1	LH INNER DOOR	ALL
32	Q9-50312-43	1	RH DOOR ASSY E/GCCO	ALL
	Q9-50312-431	1	RH DOOR ASSY E/GCCO SOLID	GCOFSD
33	Q9-GCCO-161	1	SNORKEL ASSY	ALL
34	Q9-GCCO-224-2	1	BAFFLE REAR ASS	ALL
35	2C-20112--02	4	SCREW, SHLDR THUMB	ALL
NI	2A-80400-01	2	ORIFICE SPUD UNDRILLED	GCOD-NAT
NI	Y9-80400-14	2	ORIFICE SPUD .0595 #53	GCOD-NAT

**IMPORTANT: WHEN ORDERING, SPECIFY VOLTAGE OR TYPE GAS DESIRED
 INCLUDE MODEL AND SERIAL NUMBER**

PAGE 1
 OF 1

Some items are included for illustrative purposes only and in certain instances may not be available.



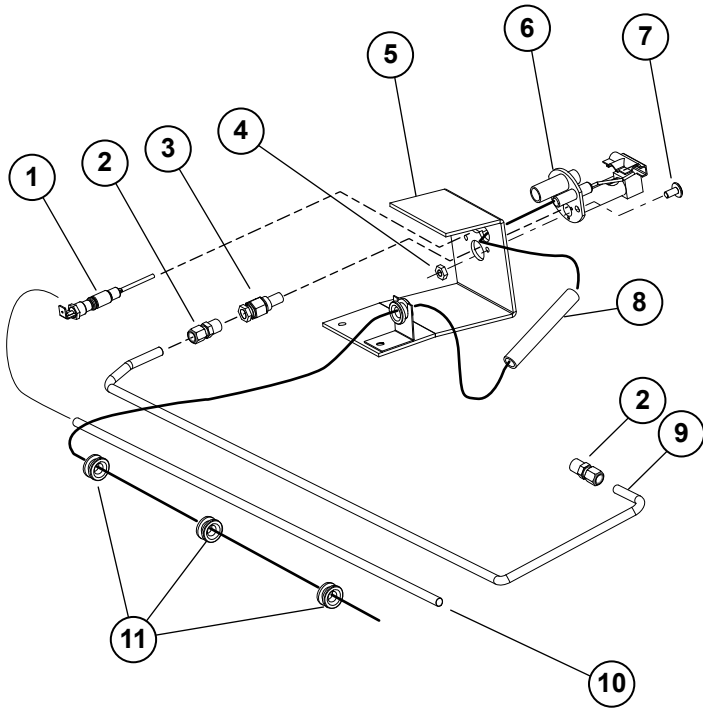

DETAIL A
Pilot Burner Assembly

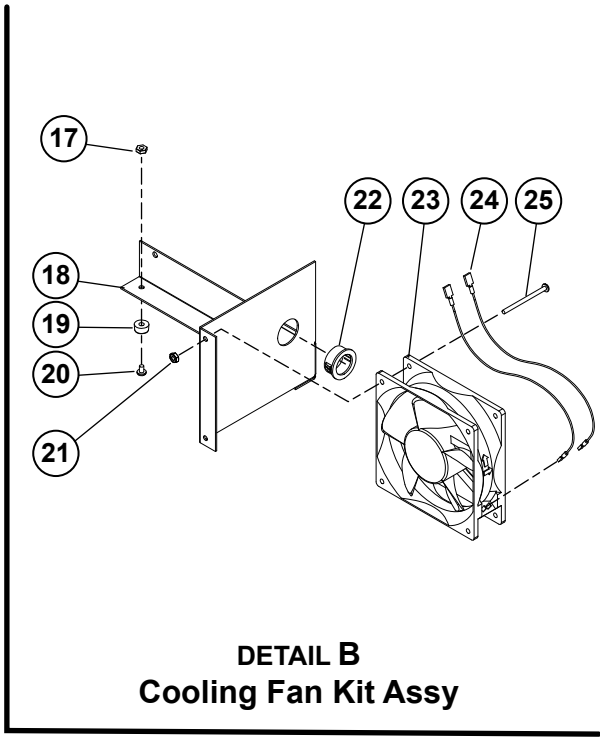

DETAIL B
Cooling Fan Kit Assy

Manifold Assembly

Available in Assembly only

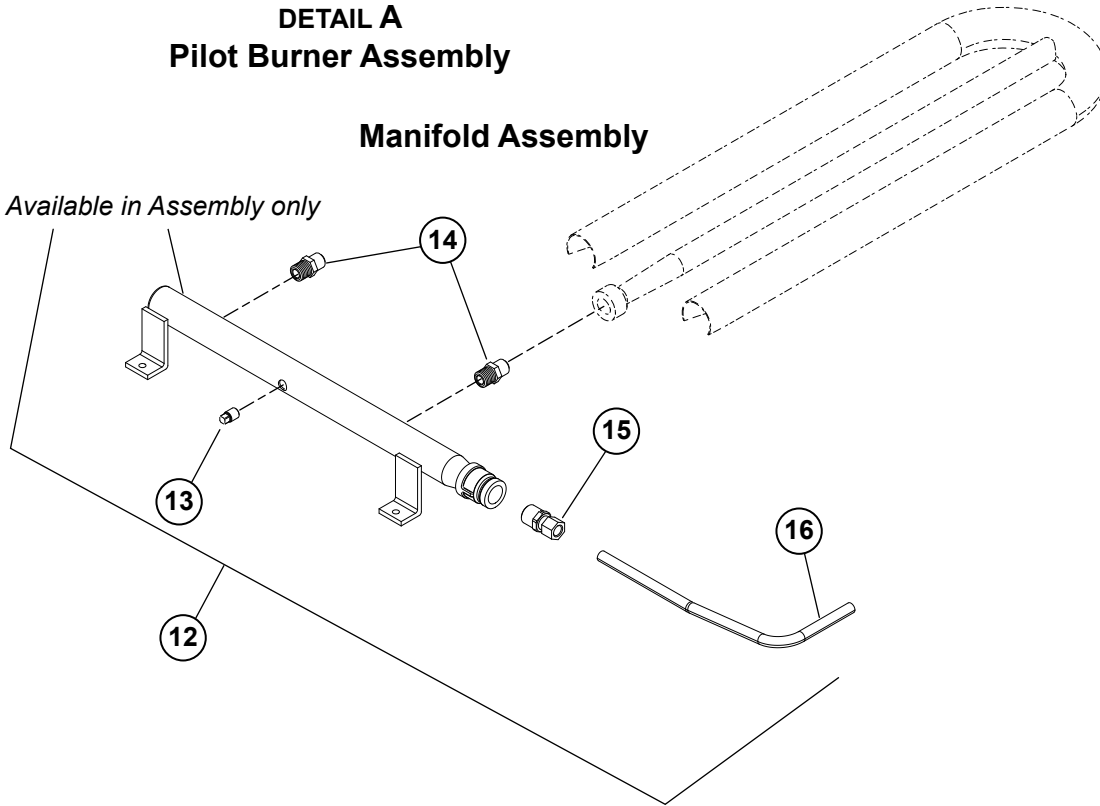

Model:
GCOD/F-NAT & GCOD/F-LP
Detail A: Gas Convection Oven Pilot & Manifold Assy
Detail B: GCCO Cooling Fan Kit Assy



PARTS LIST

May 30, 2013 Rev A

Model No: GCOF-PPNATFD, GCOD-PT-NAT, GCOD-PT-LP1, GCOF-PT-NAT, GCOF-PTNATMF
GAS FULL SIZE CONVECTION OVEN, PILOT BURNER, MANIFOLD & COOLING FAN ASSEMBLY

Key Number	Part Number	Qty Per	Description
1	2E-41100-07	1	SENSOR FLAME PROBE GCCO ALL
2	2K-70101-32	2	STL TBE UNION 1/2CC X 1/2NPT-M ALL
3	2A-80401-04	1	PLT BURNR ORFCE.021DRL NG GCCO-NAT
	2A-80401-05	1	PLT BURNR ORFCE.010DRL LP GCCO-LP
4	2C-20301-15	2	NUT HEX 10-32 PLTD ALL
5	Q9-GCCO-321	1	JOHNSON PILOT BRACKET ALL
6	2J-80201-14	1	PILOT LT BRNR HRZTL JHNSN ALL
7	2C-20101-24	2	SCRW MS PLT 10-32 X .375 ALL
8	2I-70803-02	1	CERAMIC BUSH 3 TBE ALL
9	Q9-GCCO-322	1	PILOT TUBE ALL
10	1O-71400-13	18 inch.	SLEEVING-TEFLON 1/4X .030 ALL
11	2I-70803-04	6	CERMC INSLTR 9/32ID11/16 ALL
12	Q9-GCCO-706	1	MANIFOLD ASSY NAT
	Q9-GCCO-706-WP	1	MANIFOLD ASSY LP
13	2K-70308-01	1	PIPE PLUG REG 1/8 NPT BLK ALL
14	Y9-80400-13	2	ORIFICE SPUD .0890 #43 NAT
	Y9-80400-14	2	ORIFICE SPUD .0595 #53 LP
15	2K-70310-01	1	BELL RDUC 1/2-3/8BLK IRN ALL
16	Q9-GCCO-263-1	1	TUBE 'A' ALL
17	2C-20301-11	2	NUT HEX 8-32 PLTD Q9-60102-171, Q9-60102-1711
18	Q9-GCCO-801	1	GCCO COOLING FAN BRACKET Q9-60102-171, Q9-60102-1711
19	2A-70805-03	2	RBBR BMPT RECSSED .25X.50 Q9-60102-171, Q9-60102-1711
20	2C-20101-64	2	SCRW PHD MS M4 X 6 PLTD PHIL Q9-60102-171, Q9-60102-1711
21	2C-20301-10	2	NUT HEX 6-32 PLTD Q9-60102-171, Q9-60102-1711
22	2K-70801-09	1	SNAP BUSH 1 SB1000-12 Q9-60102-171, Q9-60102-1711
23	2U-30200-45	1	MOTOR W/FAN AXIAL 115VAC 70 C Q9-60102-171
	2U-30200-46	1	MOTOR W/FAN AXIAL 220VAC 70 C Q9-60102-1711
24	Q9-GCCO-802	2	HARNESS OVEN Q9-60102-171, Q9-60102-1711
25	2C-20109-14	2	SCRW S/S 6-32 X 2 R/H M/S Q9-60102-171, Q9-60102-1711
NI	2V-80505-11	1	CONVERSION KIT NG TO LP
NI	2V-80505-10	1	COMBI VALVE

**IMPORTANT: WHEN ORDERING, SPECIFY VOLTAGE OR TYPE GAS DESIRED
 INCLUDE MODEL AND SERIAL NUMBER**

PAGE 1
 OF 1

Some items are included for illustrative purposes only and in certain instances may not be available.



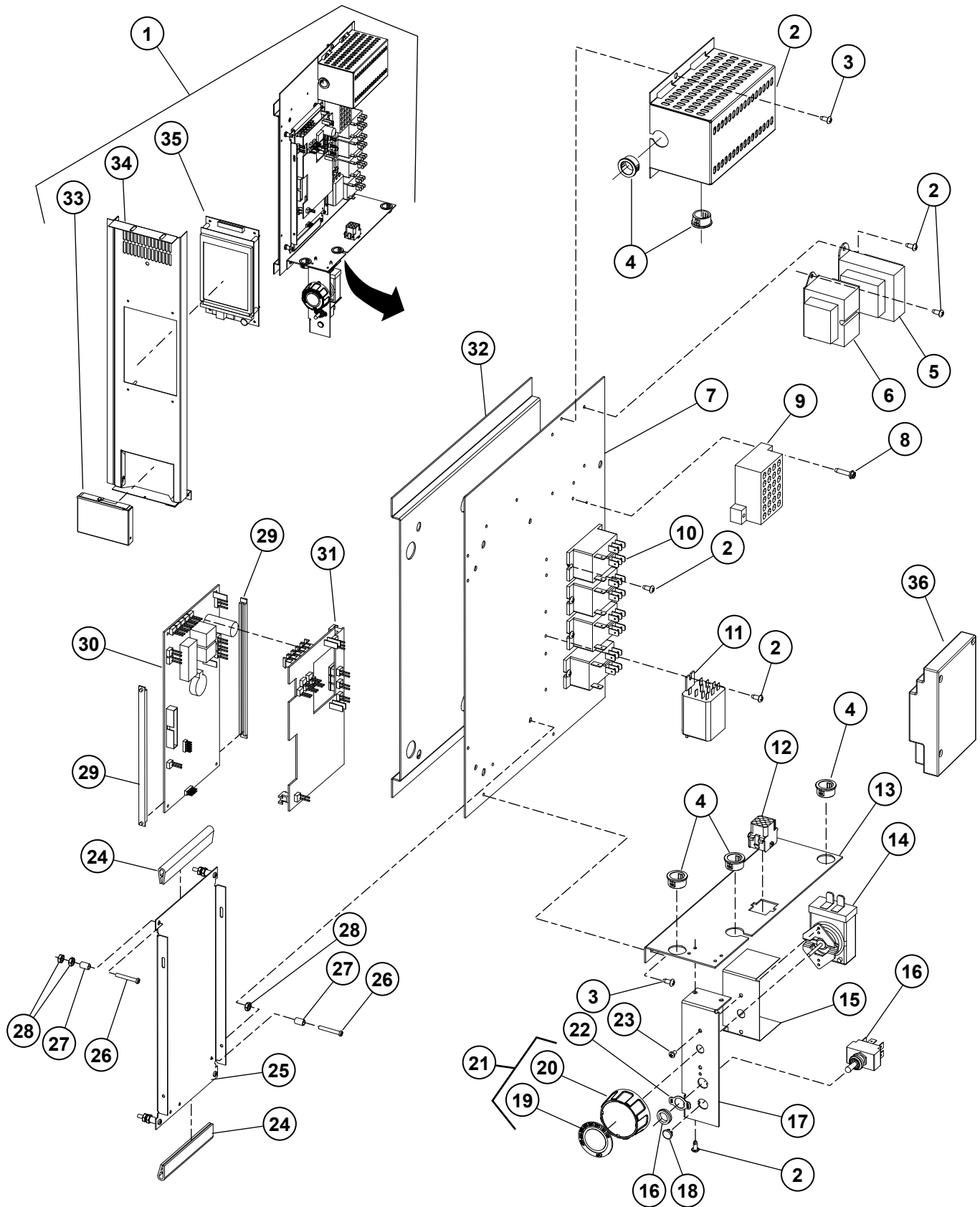

Detail C

Model:
 GCCOPPP (Purple Plus) & GCCOPPT (Platinum)
 Full Size Gas Control Panels Assemblies

Lang[®]

SK2346

Rev. A 11/26/14

PARTS LIST

May 30, 2013 Rev A

Model No: GCOF-PPNATFD, GCOD-PT-NAT, GCOF-PT-NAT/LP, GCOF-PTNATMF/CO
Commercial Full Size Gas Convection Oven Control Panel Assy

Key Number	Part Number	Qty Per	Description	
1	Q9-GCCOPPT	1	PANEL GCCO PLATINUM	GCOD-PT-NAT, GCOF-PT-NAT, GCOF-PTNATMF, GCOF-PTNATCO, GCCO-PT-NCO, GCCO-PT-NFD, GCCO-PT-PCO, GCCO-PTSTM-N
1	Q9-GCCOPPP	1	PANEL GCCO PURPLE PLUS	GCOF-PPNATFD, GCCO-PP-N, GCCO-PP-PFD, GCCO-PPSTM-N
2	Q9-ECCO-224-2	1	TRANSFORMER COVER	GCCOPPT, GCCOPPP
3	2C-20102-08	17	SCRW PHD ST 8-32X.375	GCCOPPT, GCCOPPP
4	2K-70801-04	4	SNAP BUSH 3/4 SB750-10	GCCOPPT
	2K-70801-04	3	SNAP BUSH 3/4 SB750-10	GCCOPPP
5	2E-31400-07	1	XFORMR120-208-240/24V40VA	GCCOPPT, GCCOPPP
6	2E-31400-27	1	XFORMR 120V/24-12 40VA	GCCOPPT, GCCOPPP
7	Q9-GCCO-223-31	1	SLIDE SUPPORT C,P,PP	GCCOPPT, GCCOPPP
8	2C-20102-05	2	SCRW HXHD ST 8-32X.75	GCCOPPT, GCCOPPP
9	2E-30503-01	1	TRM BLOCK 24 POS QK CON	GCCOPPT, GCCOPPP
10	2E-30701-05	4	CONTC 2POLE 30A 24VAC P &	GCCOPPT, GCCOPPP
11	2E-30600-02	1	RELAY 240VAC 3FORMC FLNG	2E-GCCO-610, GCCOPPP-NI, GCCOPPT-PE
	2E-30600-06	1	RELAY 115VAC - 3FORMC- 2DPT	110V UNITS
12	2J-40301-49	1	CONN 9PIN CAP HOUSING	2E-GCCO-610
13	Q9-GCCO-223-5	1	LOWER SHIELD	GCCOPPT, GCCOPPP
14	2T-30402-27	1	STAT ADJ 450 DEG 48 PILOT	GCCOPPT, GCCOPPP
15	Q9-GCCO-223-7	1	SWITCH INSULATOR	GCCOPPT, GCCOPPP
16	2E-30303-06	2	SWT TOG ON-ON DPDT BLK	GCCOPPP
17	Q9-GCCO-223-8	1	AUXILLARY STAT MOUNT	GCCOPPT, GCCOPPP
18	2P-70903-08	1	PLG BTN PLTD MTL 5/16	
19	2R-70702-08	1	DIAL PLATE 450o STAT	GCCOPPT, GCCOPPP
20	2R-70700-01	1	KNOB BLNK UNIVERSAL BLACK	GCCOPPT, GCCOPPP
21	TBD		KNOB ASSEMBLY	
22	2E-30303-05	1	SWT PLATE ON/OFF	GCCOPPT, GCCOPPP
23	2C-20101-77	2	SCRW MS PLT 6-32 X .25	GCCOPPT, GCCOPPP
24	Q9-EH-502	2	TRIMLOCK 7 3/4	GCCOPPT, GCCOPPP
25	Q9-50307-47	1	CPU MOUNT	GCCOPPT, GCCOPPP
26	2C-20101-17	5	SCRW RND MS 6-32X1 PLTD	GCCOPPT, GCCOPPP
27	2A-20501-01	5	SPCR FBR 1/4 OD #8 ID 3/8	GCCOPPT, GCCOPPP
28	2C-20301-10	9	NUT HEX 6-32 PLTD	GCCOPPT, GCCOPPP
29	2E-41800-02	2	PCB GUIDE 6675 6.675 LG	GCCOPPT, GCCOPPP
30	2J-40102-W26	1	UNIVERSAL CPU PP/PT/EZO	GCCOPPT, GCCOPPP
31	Q9-40102-51-2	1	CIRBD FILTER (no used w/2J-40102-W26)	
				GCOD-PTNAT, GCOF-PPNATFD, GCOF-PTNATMF
32	Q9-GCCO-223-21	1	SLIDE C,P,PP	GCCOPPT, GCCOPPP
33	Q9-60102-904	1	ACCESS COVER - ECCO/GCCO	GCCOPPT, GCCOPPP
34	Q9-60101-882	1	CONTROL FRT W/LABEL PT-ECCO/GC	GCCOPPT
	Q9-60101-881	1	CONTROL FRT W/LABEL PP-ECCO/GC	GCCOPPP, GCCOPPP-NI
35	2J-40102-25	1	DISPLAY BRD,320x240,DB170-001	GCCOPPT
	2J-40102-24	1	DISPLAY 4X20 MDL.DA170-001	GCCOPPP
36	2J-80300-08	1	SPARK IGN CONTROL GCCO	GCCOPPT, GCCOPPP
NI	2E-GCCO-610	1	HARNESS 24 VOLT PT & PP	GCCOPPT, GCCOPPP
NI	2E-GCCO-609	1	HARNESS 120 VOLT PT & PP	GCCOPPT, GCCOPPP
NI	2E-GCCO-608	1	HARNESS MOTOR PT & PP	GCCOPPT, GCCOPPP
NI	2M-61111-145	1	WD GCCO-PP 120VAC	GCCOPPP
NI	2M-61111-146	1	WD GCCO-PT 120VAC	GCCOPPT
NI	2J-31110-W1	1	USB PNL MNT CABLE	

**IMPORTANT: WHEN ORDERING, SPECIFY VOLTAGE OR TYPE GAS DESIRED
 INCLUDE MODEL AND SERIAL NUMBER**

PAGE 1
 OF 1

Some items are included for illustrative purposes only and in certain instances may not be available.



WIRING DIAGRAM 220/240-Volt

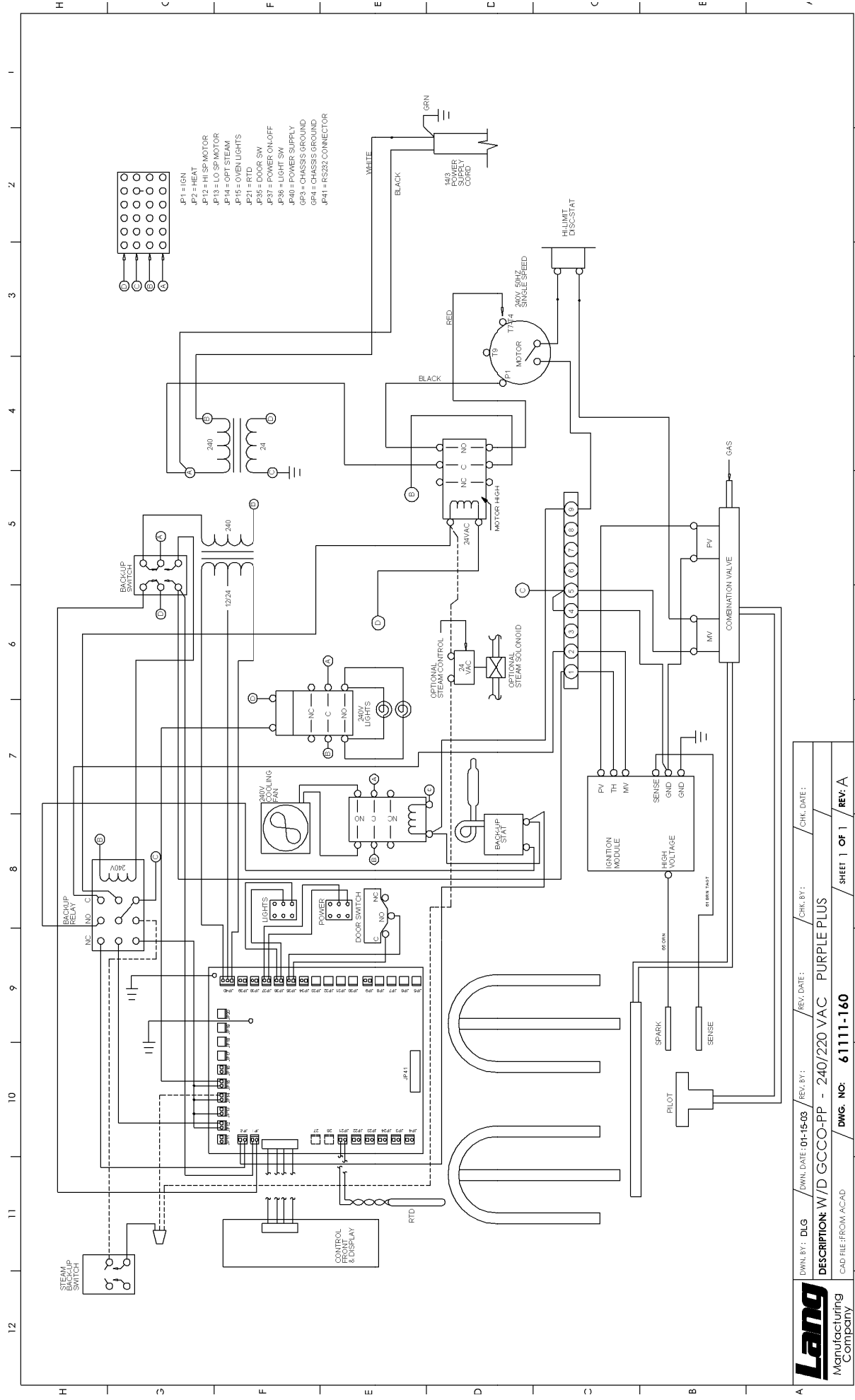

	DWG. NO. 61111-160	SHEET 1 OF 1	REV: A
	DESCRIPTION: W/D GCCO-PP - 240/220 VAC PURPLE PLUS	CHK. BY:	CHK. DATE:
	CAD FILE: FROM ACAD	REV. DATE:	REV. BY:

STAR INTERNATIONAL HOLDINGS INC. COMPANY

Star - Holman - Lang - Wells - Bloomfield - Toastmaster

10 Sunnen Drive, St. Louis, MO 63143 U.S.A.

(314) 678-6303

www.star-mfg.com