

Service Manual

Applicable Models	Model Code
UR-BD198-DQ	22032010000092
UR-BD198-DQ	22032010000028
UR-BD198-DQ	22032010000721
UL-BD198-DQ	22032010000091
UR-BD198-DQ	22032010000106

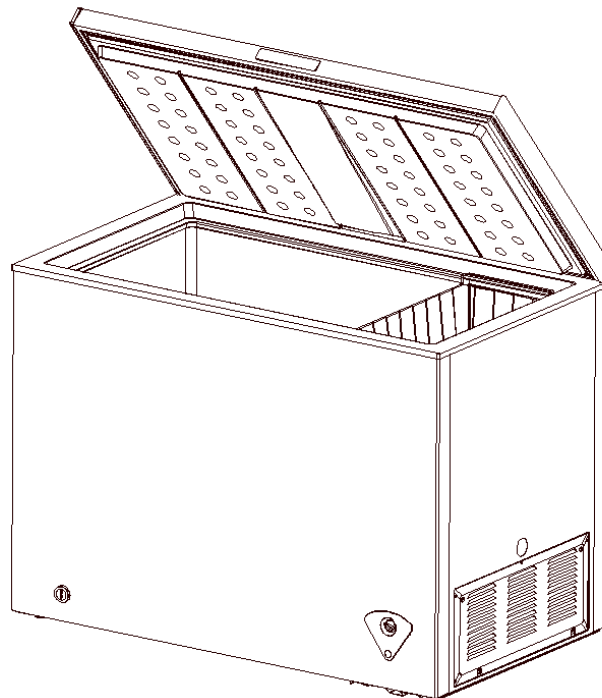

(The picture is only for reference, and specific appearance and configuration are subject to the real product)

Prepared by	R&D: Cheng Jun
Reviewed by	QA: Wang Tao SVC: Chen Lei
Approved by	R&D: Zhang Huawei SVC: Guang Tao shuai



Important Safety Notice

The Maintenance Manual is only for the use of maintenance personnel with certain experience and background in electrical, electronic and mechanical field.

Any attempt to repair main devices may lead to personal injury and property loss.

Manufacturers or distributors are not responsible for the content of the Manual and interpretation thereof.

Midea Refrigerators

Technical Maintenance Manual

Copyright ©2016

All rights reserved. Replication of all or part of the Manual in any forms shall not be allowed without written approval by the Overseas Sales Corporation of Midea Refrigerators.

目录 Contents

1.Safety Warning Code.....	5
1.1 Warning for operation safety	5
1.2 Safety instruction for refrigerant	8
2.Description for product features.....	9
3.Installation and commissioning.....	10
3.1 Handling	10
3.2 Door Disassembly and Assembly(None).....	10
3.3 Installation location	10
3.4 Leveling of the refrigerator	11
3.5 Door reversal (None).....	11
3.6 Installation of handle(None).....	11
3.7 Installation of door lock(None)	11
3.8 Adjustment to level the door(None).....	11
4.Terms.....	11
4.1 Definition of model (None).....	11
4.2 Location of nameplate	11
5.Product specification	12
5.1 Type specification(None)	12
5.2 Electrical parameters	12
5.3 Inside temperature	12
5.4 Defrosting parts(None).....	13
5.5 Circuit diagram.....	13
6.Internal view and dimension	14
6.1 Main parts and their names	14
6.2 External dimension.....	15
7.Refrigerating piping system and circulating route of cooling air.....	16
7.1 Refrigerating piping system	16
7.2 Circulating route of cooling air	16
8.Dismantling of parts	17
8.1 Parts on the door.....	17
8.2 Parts inside the refrigerator	18
8.3 Light system.....	19
8.4 Evaporator and temperature sensing system	19
8.5 Condenser system.....	19
8.6 Compressor case.....	20
8.7 Display control board	21
9. Function and operation.....	24
9.1 Operation panel	24
9.2 Temperature control	24
9.3 give an alarm (None).....	24
9.4 Defrosting.....	24

10. Circuit description	25
10.1 Power Supply(None)	25
10.2 Door trip test circuit(None)	25
10.3 Temperature test circuit(None).....	25
10.4 Fan motor circuit of the freezing chamber(None).....	25
10.5 Refrigerator fan motor circuit (None)	25
10.6 Condensing fan motor circuit (None).....	25
10.7 Damper motor circuit (None)	25
10.8 Resistance value of the sensor (R/T) (None).....	25
11. Troubleshooting Method	25
11.1 No refrigeration	25
11.2 Compressor failure	26
11.3 Noise.....	26
11.4 Inside frosting	27
11.5 Light is not on.....	28
12. Figures and details of repair parts (Documents are provided separately)	28
12.1 Figures	28
12.2 List of parts and components.....	28
13 Appendix:	28
13.1 Electrical Schematic Diagram(None).....	28
13.2 Refrigerator maintenance tooling and equipment and material.....	28

1.Safety Warning Code

1.1 Warning for operation safety

Important Safety Instructions

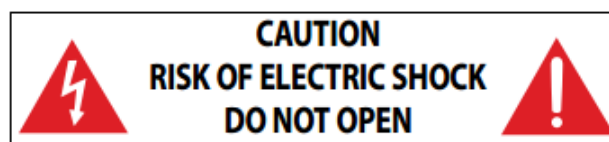

This symbol indicates that dangerous voltage constituting a risk of electric shock is present within your freezer.



This symbol indicates that there are important operating and maintenance instructions in the literature accompanying your freezer.

WARNING

- 1 Read these instructions.
- 2 Keep these instructions.
- 3 Heed all warnings.
- 4 Follow all instructions.
- 5 Do not use this appliance near water.
- 6 Clean only with a damp cloth.
- 7 Do not block any ventilation openings.
- 8 Install in accordance with the manufacturer's instructions.
- 9 Do not install near any heat sources, such as radiators, heat registers, stoves, or other apparatus that produce heat.
- 10 Do not defeat the safety purpose of the polarized or grounding-type plug. A polarized plug has two blades with one wider than the other. A grounding type plug has two blades and a third grounding prong. The wide blade or the third prong are provided for your safety. If the provided plug does not fit into your outlet, consult an electrician for replacement of the obsolete outlet.
- 11 Protect the power cord from being walked on or pinched, particularly at plugs, convenience receptacles, and the point where they exit from the appliance.
- 12 Do not attempt to modify or extend the power cord of this appliance.
- 13 Unplug this appliance during lightning storms or when it will not be used for long periods of time.
- 14 Make sure that the available AC power matches the voltage requirements of this appliance.

- 15 Do not handle the plug with wet hands. This could result in an electric shock.
- 16 Unplug the power cord by holding the plug, never by pulling the cord.
- 17 Do not turn the appliance on or off by plugging or unplugging the power cord.
- 18 Refer all servicing to qualified service personnel. Servicing is required when the appliance has been damaged in any way, such as the power-supply cord or plug is damaged, liquid has been spilled or objects have fallen into the appliance, the appliance has been exposed to rain or moisture, does not operate normally, or has been dropped.
- 19 To reduce the risk of fire or electric shock, do not expose this appliance to rain, moisture, dripping, or splashing, and no objects filled with liquids should be placed on top of it.
- 20 Do not use extension cords or ungrounded (two prong) adapters.
- 21 This appliance is not intended for use by persons (including children) with reduced physical, sensory or mental capabilities, or lack of experience and knowledge, unless they have been given supervision or instruction concerning use of the appliance by a person responsible for their safety.
- 22 Children should be supervised to ensure that they do not play with the appliance.
- 23 If the supply cord is damaged, it must be replaced by the manufacturer, its service agent, or similarly qualified person, in order to avoid a hazard.
- 24 Take off the doors and leave the shelves in place so that children may not easily climb inside.



WARNING

Electric Shock Hazard

Failure to follow these instructions can result in electric shock, fire, or death.

- 1 **WARNING**—Keep ventilation openings, in both the freezer and the built-in structure, clear of obstruction.
- 2 **WARNING**—Do not touch the interior of the freezer with wet hands. This could result in frost bite.
- 3 **WARNING**—Do not use mechanical devices or other means to accelerate the defrosting process, other than those recommended by the manufacturer.
- 4 **WARNING**—Do not damage the refrigerant circuit.

- 5 **WARNING**—Do not damage the refrigerant tubing when handling, moving, or using the freezer.
- 6 **WARNING–DANGER**—Never allow children to play with, operate, or crawl inside the freezer.
Risk of child entrapment. Before you throw away your old freezer:
 - 1) Take off the doors
 - 2) Leave the shelves in place so that children may not easily climb inside
- 7 Unplug the freezer before carrying out user maintenance on it.
- 8 This freezer can be used by children age eight years and older and persons with reduced physical or mental capabilities or lack of experience and knowledge if they are given supervision or instruction concerning the use of the freezer in a safe way and understand the hazards involved. Children should not play with the freezer. Cleaning and maintenance should not be performed by children without supervision.
- 5 **WARNING**—Do not damage the refrigerant tubing when handling, moving, or using the freezer.
- 6 **WARNING–DANGER**—Never allow children to play with, operate, or crawl inside the freezer.
Risk of child entrapment. Before you throw away your old freezer:
 - 1) Take off the doors
 - 2) Leave the shelves in place so that children may not easily climb inside
- 7 Unplug the freezer before carrying out user maintenance on it.
- 8 This freezer can be used by children age eight years and older and persons with reduced physical or mental capabilities or lack of experience and knowledge if they are given supervision or instruction concerning the use of the freezer in a safe way and understand the hazards involved. Children should not play with the freezer. Cleaning and maintenance should not be performed by children without supervision.
- 9 If a component part is damaged, it must be replaced by the manufacturer, its service agent, or similar qualified persons in order to avoid a hazard.
- 10 Please dispose of the freezer according to local regulations as the freezer contains flammable gas and refrigerant.
- 11 Follow local regulations regarding disposal of the freezer due to flammable refrigerant and gas. All refrigeration products contain refrigerants, which under the guidelines of federal law must be removed before disposal. It is the consumer's responsibility to comply with federal and local regulations when disposing of this product.

- 12 This freezer is intended to be used in household and similar environments.
- 13 Do not store or use gasoline or any flammable liquids inside or in the vicinity of this freezer.
- 14 Do not use extension cords or ungrounded (two-prong) adapters with this freezer. If the power cord is too short, have a qualified electrician install an outlet near the freezer. Use of an extension cord can negatively affect the freezer's performance.

Grounding requirement

This freezer must be grounded. This freezer is equipped with a cord having a grounding wire with a grounding plug. The plug must be inserted into an outlet that is properly installed and grounded.

Improper use of the grounding plug can result in a risk of electric shock. Consult a qualified electrician or service person if the grounding instructions are not completely understood, or if doubt exists as to whether the freezer is properly grounded.

1.2 Safety instruction for refrigerant

⚠ WARNING  **Explosion Hazard.**

Keep flammable materials and vapors, such as gasoline, away from freezer. Failure to do so can result in fire, explosion, or death.

DANGER—Risk of Fire or Explosion. Flammable Refrigerant Used. To Be Repaired Only By Trained Service Personnel. Do Not Use Mechanical Devices. Do Not Puncture Refrigerant Tubing.
 CAUTION—Risk of Fire or Explosion. Flammable Refrigerant Used. Consult Repair Manual/Owner's Guide Before Attempting To Service This Product. All Safety Precautions Must be Followed.
 CAUTION—Risk of Fire or Explosion. Dispose of Properly In Accordance With Federal Or Local Regulations. Flammable Refrigerant Used.
 CAUTION—Risk of Fire or Explosion Due To Puncture Of Refrigerant Tubing; Follow Handling Instructions Carefully. Flammable Refrigerant Used.



2. Description for product features

This product is provided with following features:

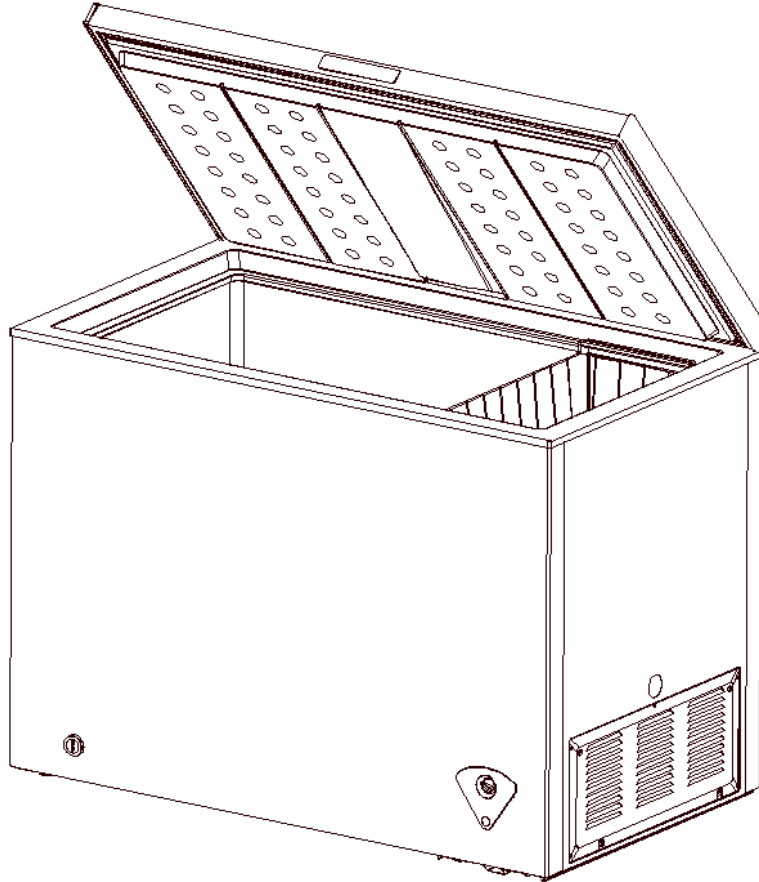

(The picture is only for reference, and specific appearance and configuration are subject to the real product)

- 1) TEMP control panel of sector, OFF function make the refrigerator stop working

3. Installation and commissioning

3.1 Handling

- 1) Protect the refrigerator in moving it
Same as shown as left photo, please move it by handcart with cushion
- 2) Remove all packing materials and bottom cushion, then move into house for placement
- 3) After moving it to appropriate location, wait for 2 hours before power on.



3.2 Door Disassembly and Assembly(None)

3.3 Installation location

Location that is easy for ventilation shall be chosen to facilitate heat dissipation, enhance its performance and reduce the energy consumption.

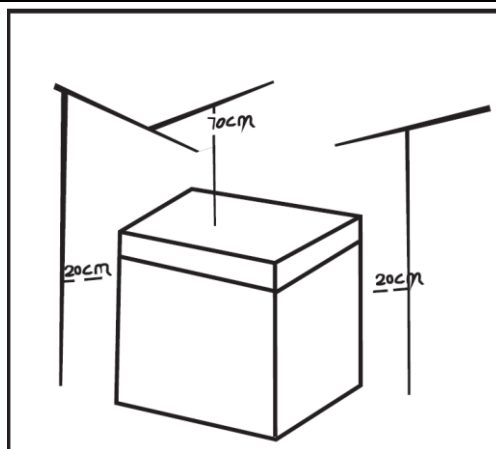

3.4 Leveling of the refrigerator

If the refrigerator cannot be placed steadily, adjust the footing to level it.

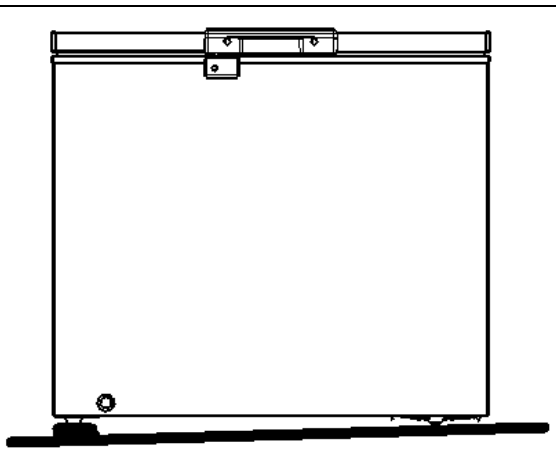

3.5 Door reversal (None)

3.6 Installation of handle (None)

3.7 Installation of door lock (None)

3.8 Adjustment to level the door (None)

4. Terms

4.1 Definition of model (None)

4.2 Location of nameplate

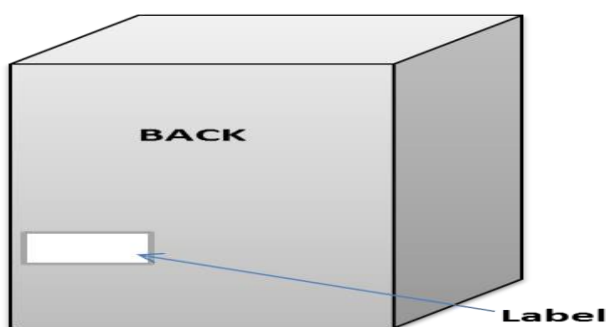

(The picture is only for reference, and specific appearance and configuration are subject to the real product)

5. Product specification

5.1 Type specification (None)

5.2 Electrical parameters

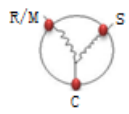
Product Name			UR-BD198-DQ	UR-BD198-DQ	UR-BD198-DQ	UL-BD198-DQ	UR-BD198-DQ
Product Code			22032010000092	22032010000028	22032010000721	22032010000091	22032010000106
Name	Item	Type	Specification	Specification	Specification	Specification	Specification
Compressor	Compressor	/	FZ59E1H	FZ59E1H	FZ59E1H	EE35E1F	HYB60MHU42 a
	rated power (W)	/	/	/	/	/	
	Capacitor	/	/	/	/	6.0 μF	8.0 μF
	Starter	PTC	8EA14C1/Q P2-4R7	8EA14C1/Q P2-4R7	8EA14C1/Q P2-4R7	8EA14C3	QP2-4R7
	Overload protector	OLP	4TM222TFB YY/DRB25T 61A1	4TM222TFB YY/DRB25T 61A1	4TM222TFB YY/DRB25T 61A1	4TM232TFB YY	DRB24P61A1
	Winding resistance of compressor wiring terminal		Rmc: 9.65±7%Ω Rsc: 8.91±7%Ω Rms=Rmc+Rsc	Rmc: 9.65±7%Ω Rsc: 8.91±7%Ω Rms=Rmc+Rsc	Rmc: 9.65±7%Ω Rsc: 8.91±7%Ω Rms=Rmc+Rsc	Rmc: 6.75±7%Ω Rsc: 8.75±7%Ω Rms=Rmc+Rsc	Rmc: 8.3±10%Ω Rsc: 6.6±10%Ω Rms=Rmc+Rsc
Motor	Condensation fan	/	/	/	/	/	/
Lights	Light of the refrigerator door	/	/	/	/	/	/
	Switch of the refrigerator door	/	/	/	/	/	/
	Indicator lamp	/	Green	Green	Green	Green	Green

5.3 Inside temperature

Temperature tolerance ≤ 2°C

Compartment	The highest (°C)	Lowest (°C)
Freezing	-12	-24

Refrigerating	/	/
Variable temperature	/	/

5.4 Defrosting parts (None)

5.5 Circuit diagram

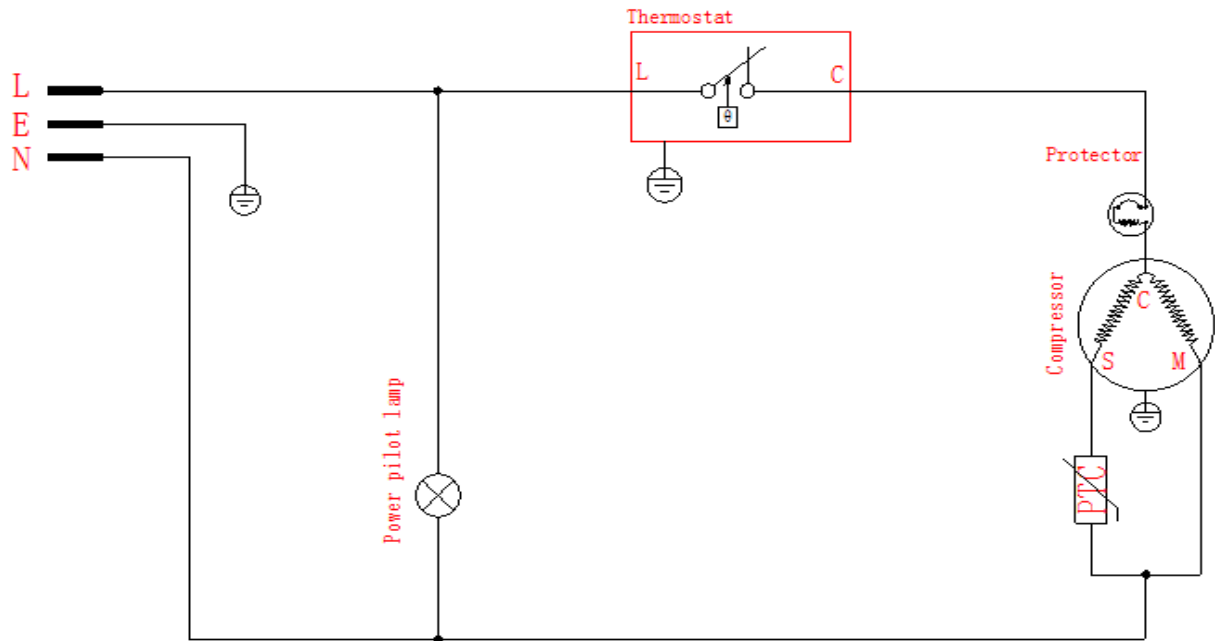

6. Internal view and dimension

6.1 Main parts and their names

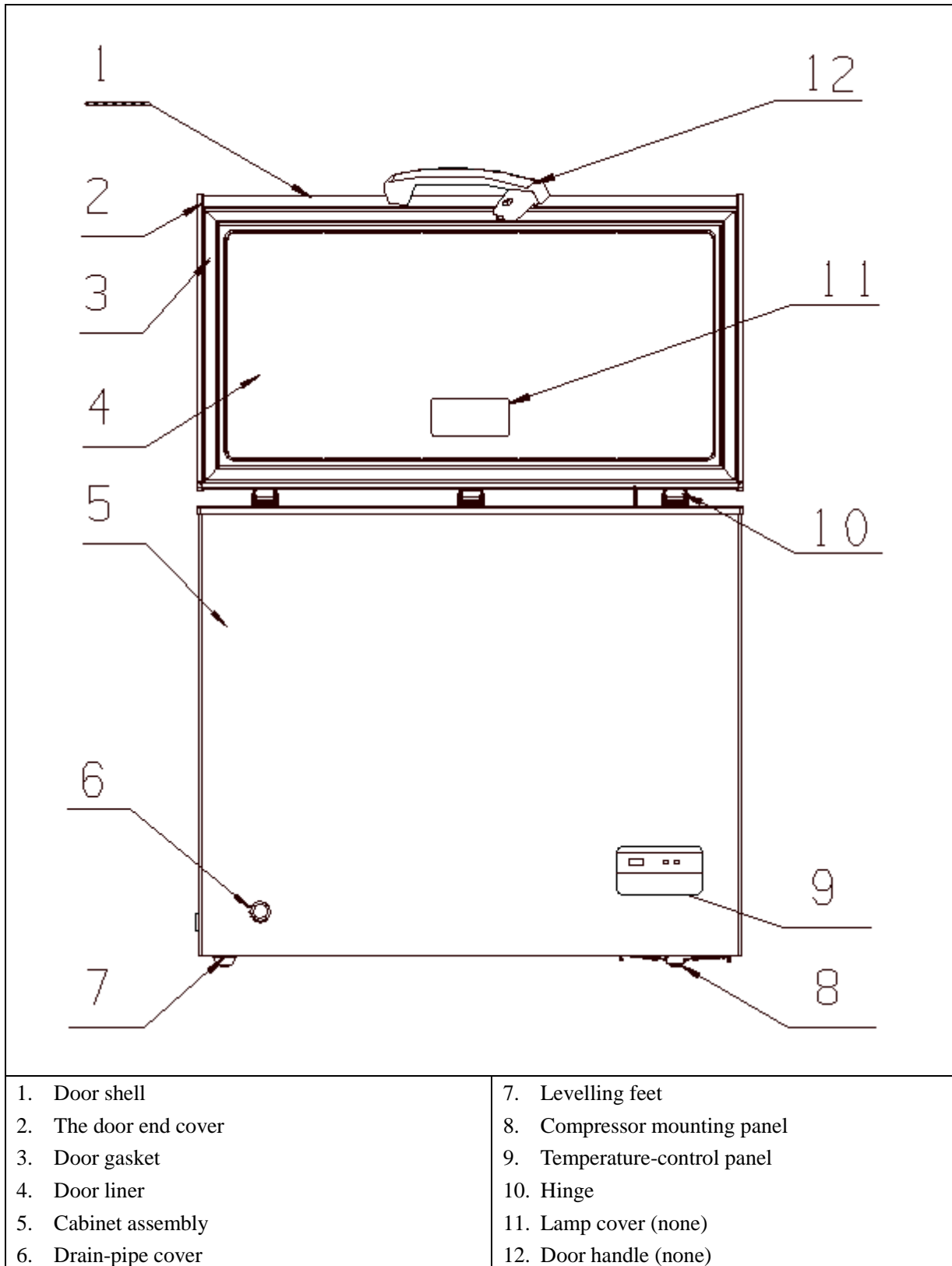

6.2 External dimension

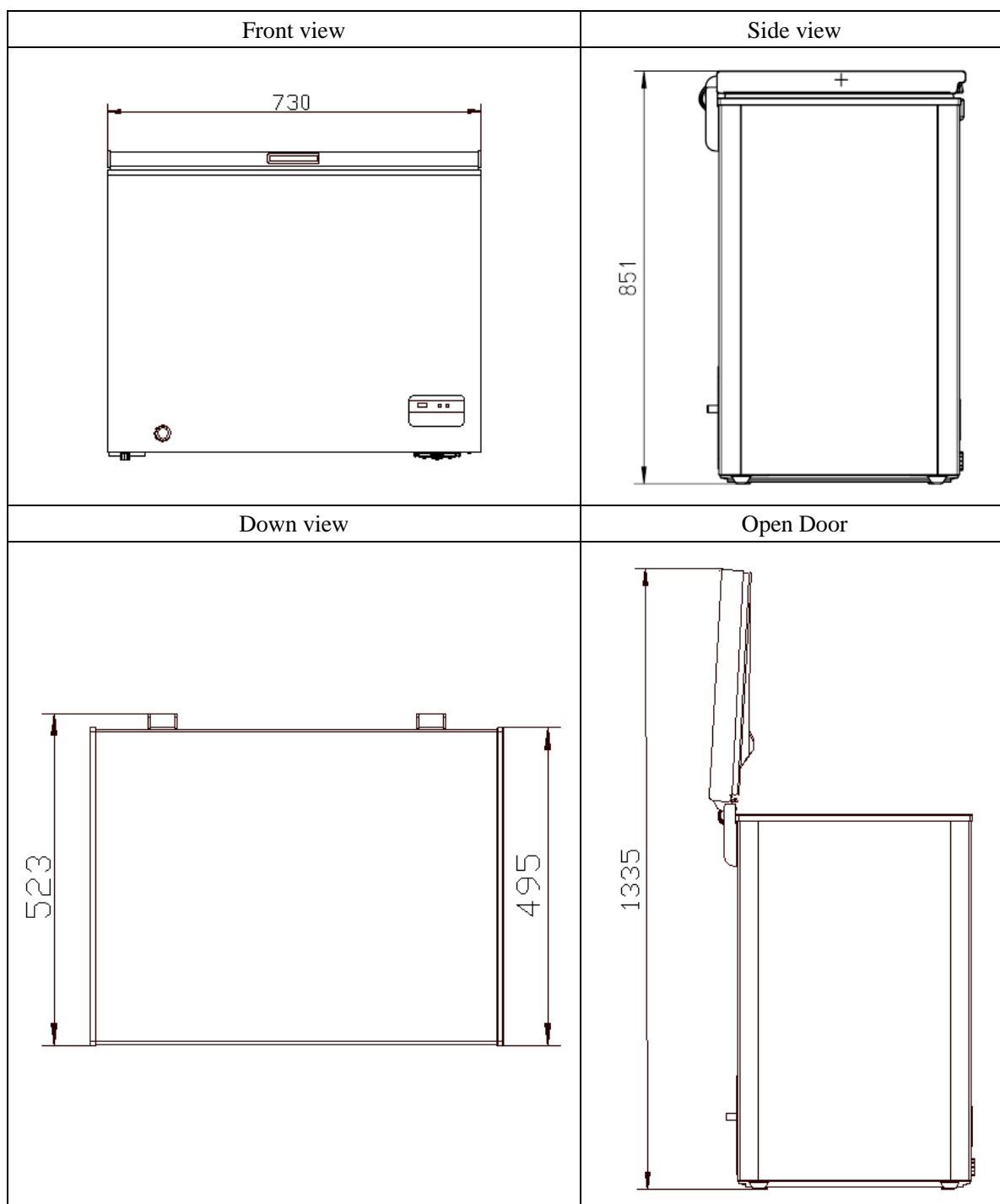

(The picture is only for reference, and specific appearance and configuration are subject to the real product)

7. Refrigerating piping system and circulating route of cooling air

7.1 Refrigerating piping system

1 Compressor → 2 Back condenser → 3 Front condenser → 4 Dry filter → 5 Capillary tube → 6 Evaporator

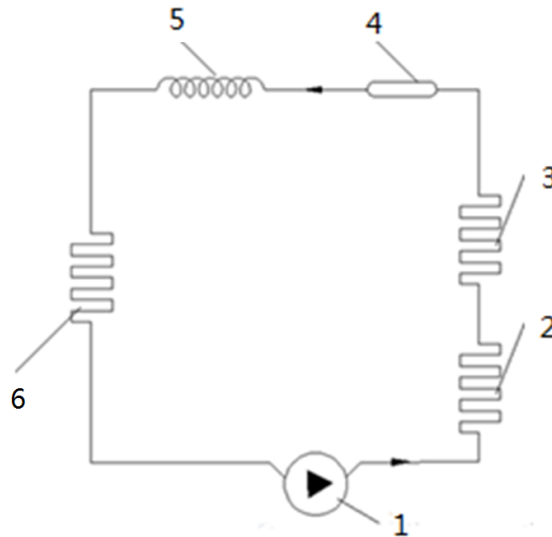

(The picture is only for reference, and specific appearance and configuration are subject to the real product)

7.2 Circulating route of cooling air

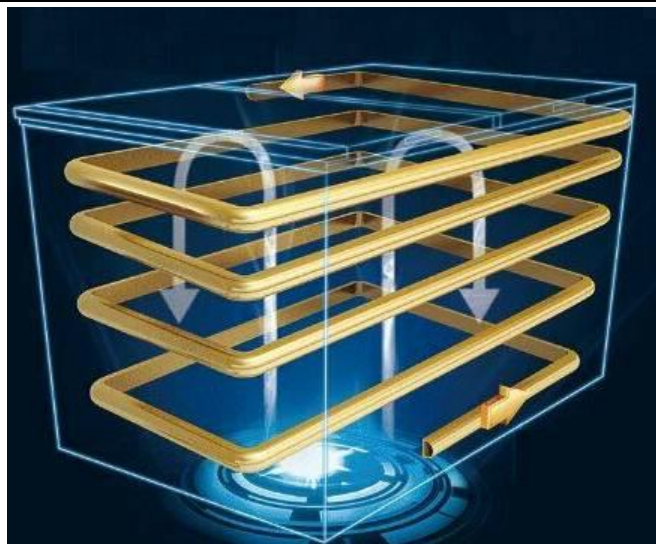

8.Dismantling of parts

8.1 Parts on the door

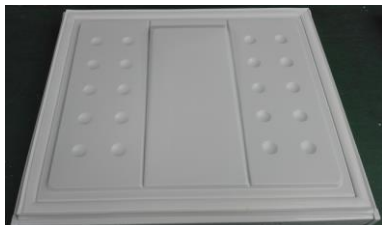
The door seal	
1) Pull the door seal from the corner	
2) Take efforts until door seal totally detaches from door inner liner groove	
3) Remove the door seal in the direction of door liner groove.	
4) Fixing the four corners and pressing smoothly.	
The hinge cover	
1) Push the hinge cover from the bottom to the top and appear displacement for the hinge cover.	

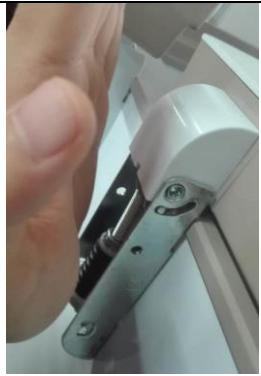
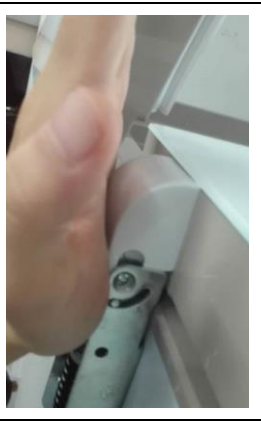
<p>2) Pull down hinge cover from the bottom.</p>		
<p>3) Slap forcefully the top hinge with the palm, and wear safety gloves for fear of cutting the hand.</p>		
<p>4) After the displacement, pull down the hinge cover.</p>		
<p>Door light disassembly and assembly</p>	<p>None</p>	

8.2 Parts inside the refrigerator

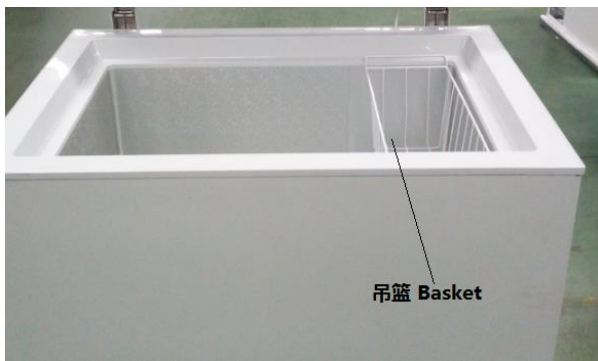
<p>Basket</p>	
<p>Open the door and removed the basket</p>	
<p>Inside water pipe cover</p>	

<p>Counterclockwise to remove the pipe cover</p>	
<p>Ice tray</p>	<p>None</p>

8.3 Light system

<p>Light</p>	<p>None</p>
<p>Light switch</p>	<p>None</p>
<p>Indicator lamp</p>	<p>None</p>





8.4 Evaporator and temperature sensing system

<p>Freezer sensor (Not replaced)</p>	<p>None</p>
<p>Ambient temperature sensor</p>	<p>None</p>
<p>Normal thermostat</p>	

8.5 Condenser system

<p>Outside condenser</p>	<p>None</p>
--------------------------	-------------

8.6 Compressor case

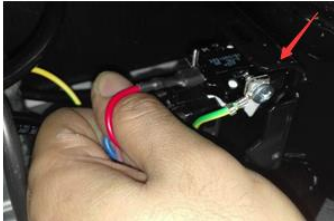
<p>shutter and compressor case</p>	
<p>Starter and protector of the compressor</p>	
<p>1. Remove the screws 1) Two screws outside 2) One screw inside</p>	
<p>2. Remove the clipping strip Slowly pull it out</p>	
<p>3. Remove the protective cover 1) Pry the protective cover slowly from the upper part, 2) Pull it out and remove it.</p>	
<p>4. Remove the starter and protector Unplug the starter and protector (you can use a screwdriver to pry it slowly)</p>	
<p>5. The reverse process can complete installation.</p>	<p>/</p>
<p>Piping system in the compressor case↓</p>	

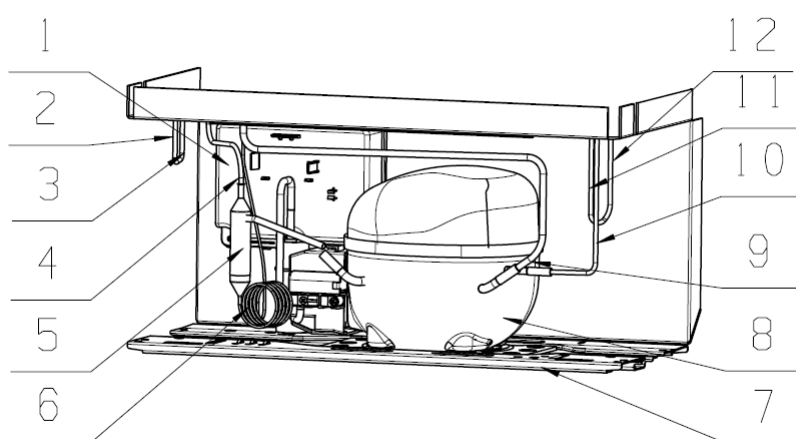

1 Main Control Board Component	7 Compressor Assembly Board
2 Front condenser pipeline-1	8 Compressor
3 Rear condenser pipeline-2	9 Suction Component
4 Anti-dew pipe-1	10 Rear condenser pipeline-1
5 Drying filter	11 Front condenser pipeline-2
6 Capillary	12 Anti-dew pipe-2
Condenser fan motor (None)	
Fan motor	None
Standby condenser	None

8.7 Display control board

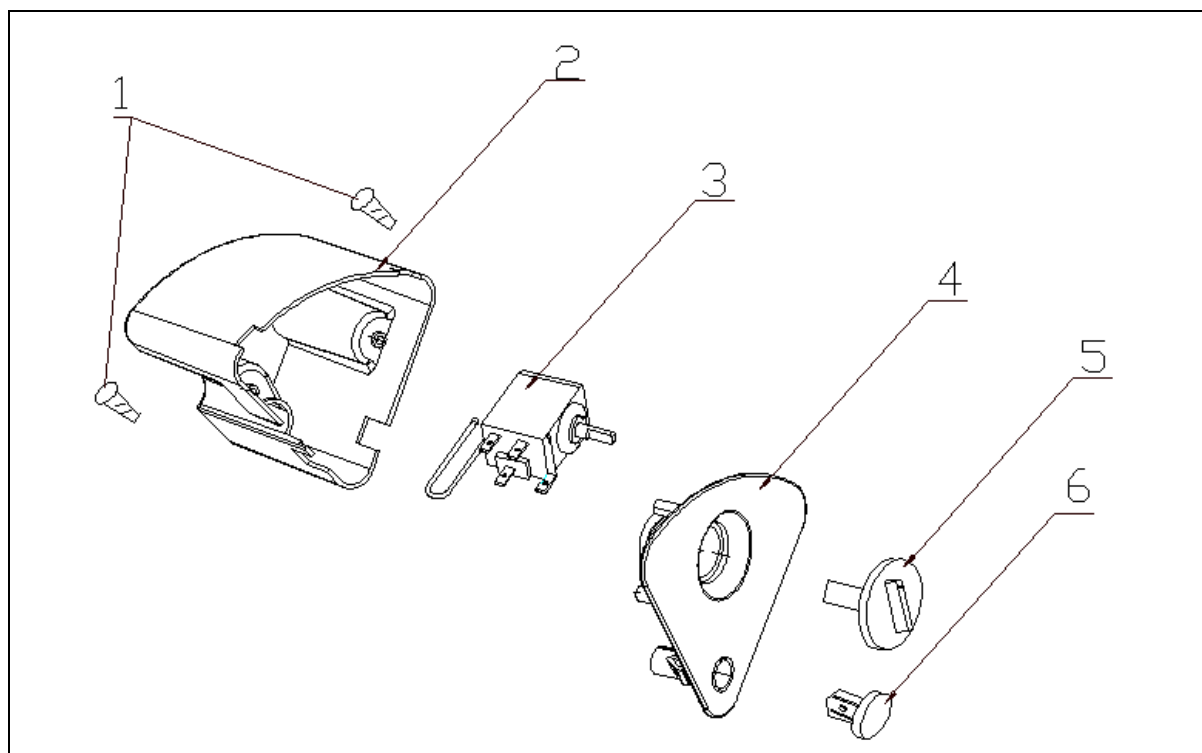

1 Screw	4 Temperature control board
2 Temperature control box cover	5 Temperature control knob

3 Temperature controller	6 Indicator
Destuffing	
<p>1) pull out the thermostat sensors from the sensor tube sleeve</p>	
<p>2) Press the spring piece on the temperature control box and take out temperature control box components</p> <p>Note: The four spring pieces on four corners of the temperature control box shall be pressed with force. It is suggested to press the spring piece and push it out in turn.</p>	
<p>3) Dismantle the screws of temperature control box</p>	
<p>4) Remove the cover of temperature control box after taking out the power cord from card trough</p>	
<p>5) Pull out the temperature control knob with tools</p>	

6) Dismantle the controller nuts



7) Unplug the harness and remove the indicator, change Temperature-Control



9. Function and operation

9.1 Operation panel

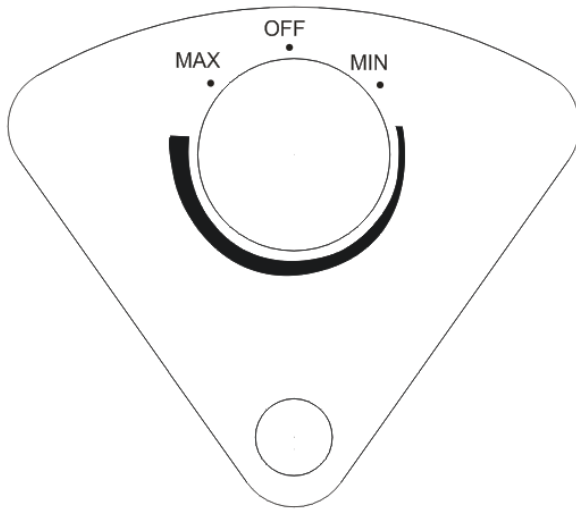

9.2 Temperature control

1. Connect the freezer to power supply and “Power” indicator will shine;
2. The temperature of the chamber is adjusted through the thermostat knob, Clockwisely rotate the thermostat knob and the interior temperature will decrease .Rotate to “MIN” gear and interior temperature will increase ; Rotate to “MAX” gear and interior temperature will decrease.
3. “OFF” stands for inoperation

9.3 give an alarm (None)

9.4 Defrosting

Unplug the freezer and open the freezer door, remove foods and drawers before defrosting;
 Open the outflow holes and drainage holes (and place water container at the outflow holes);
 indoor frost will naturally melt, wipe the defrost water with a dry, soft cloth. When the frost softens, an ice scraper might be used to the accelerate de-icing process.

- Please remove the food and put in a cool place when defrosting before removing accessories.

10. Circuit description

10.1 Power Supply(None)

10.2 Door trip test circuit(None)

10.3 Temperature test circuit(None)

10.4 Fan motor circuit of the freezing chamber(None)

10.5 Refrigerator fan motor circuit (None)

10.6 Condensing fan motor circuit (None)

10.7 Damper motor circuit (None)

10.8 Resistance value of the sensor (R/T) (None)

11. Troubleshooting Method

11.1 No refrigeration

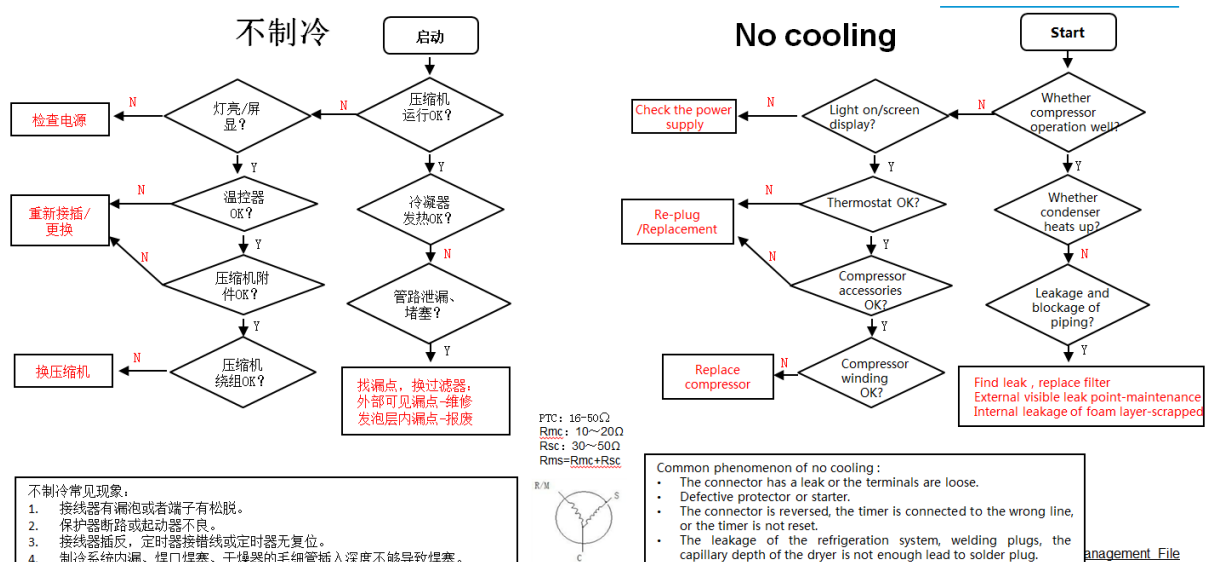

11.2 Compressor failure

压缩机不工作

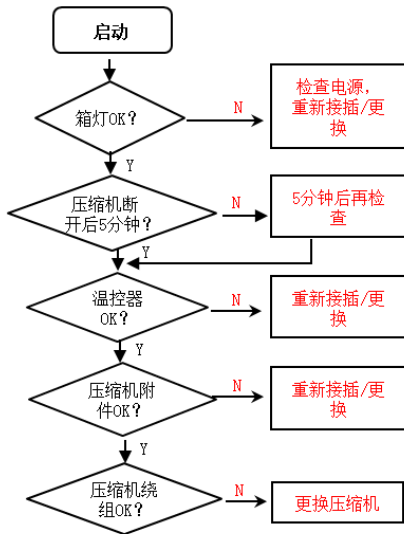

No working of compressor

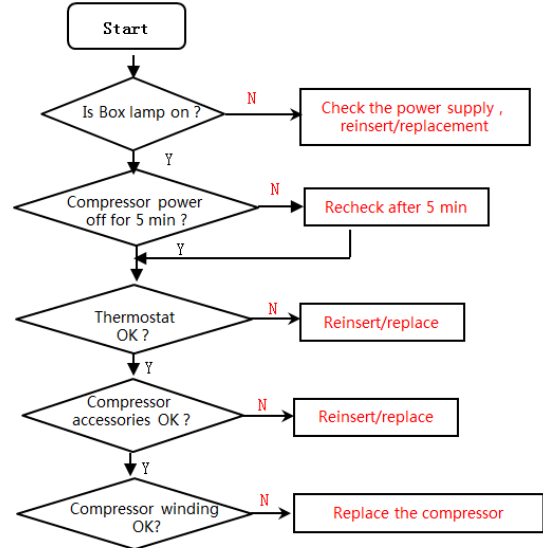

11.3 Noise

Noise

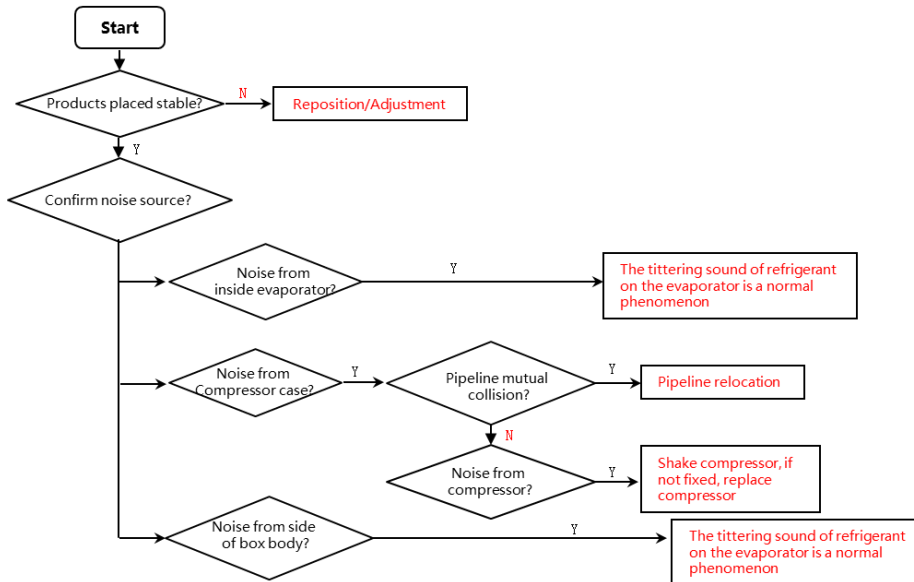

11.4 Inside frosting

Inside frosting, no defrosting

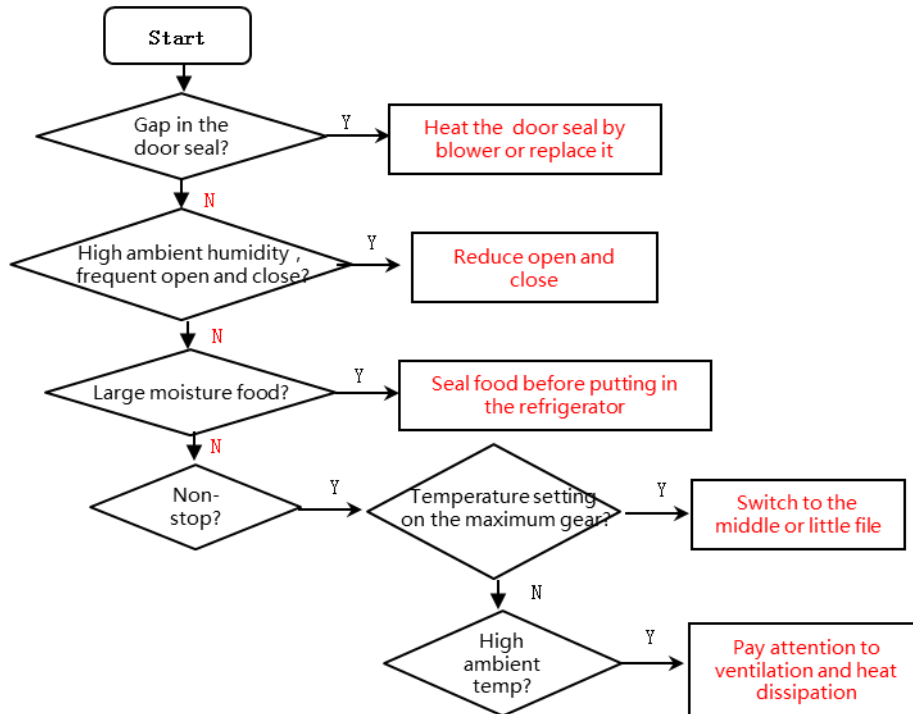

11.5 Light is not on

Light is not on

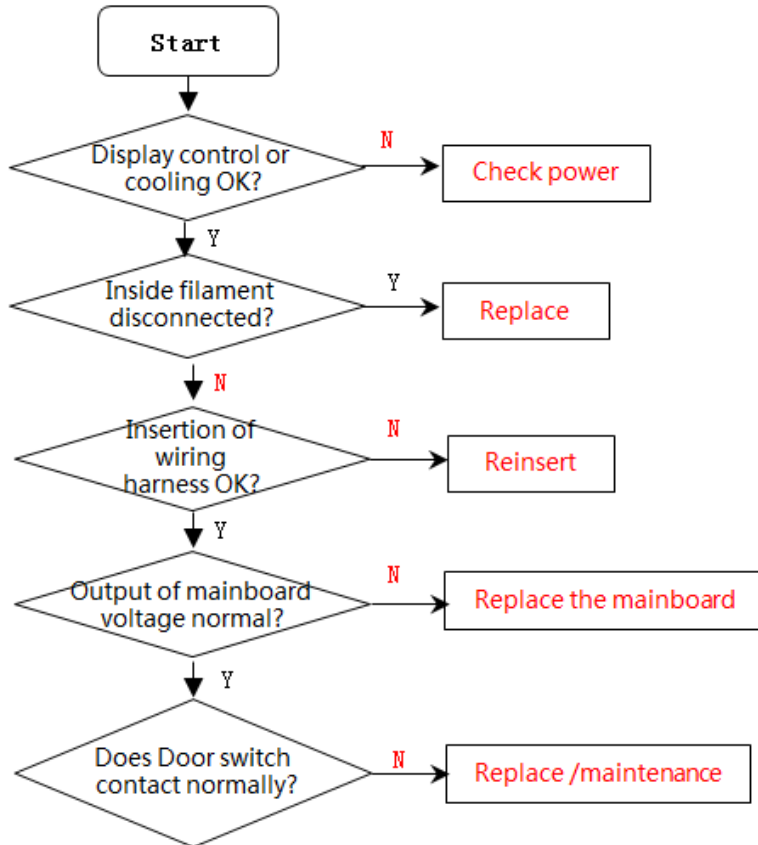

12. Figures and details of repair parts (Documents are provided separately)

12.1 Figures

12.2 List of parts and components





13 Appendix:

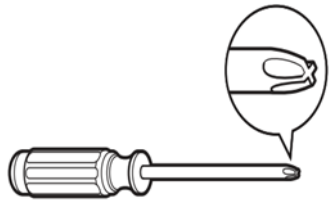
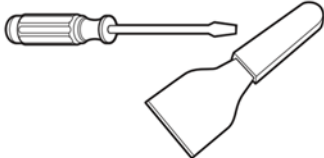
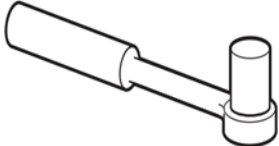

13.1 Electrical Schematic Diagram (None)

13.2 Refrigerator maintenance tooling and equipment and material



Tooling

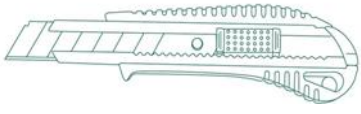

No.	Name	Photo	Main Usage
-----	------	-------	------------

1	Phillips screwdriver		screw assemble and disassemble
2	/slotted screwdriver/scrapper		screw and rivet assemble and disassemble
3	Socket spanner 5/16"		hinge and compressor screw assemble and disassemble
4	Sucker		display panel and air duct cover disassemble
5	Allen wrench (2.8~4mm)		handle assemble and disassemble
6	Vise grip pliers		sealing process tube
7	Pipe cutter		pipe cutting





8	Knife		assistive tool
9	Nipper pliers		assistive tool
10	Capillary tube scissors		Shear capillary

Equipment

No.	Name	Photo	Main Usage
1	Vacuum pump		vacuum pumping
2	Electronic scale		weighing refrigerant/gas
3	High pressure nitrogen with piezometer		pipe and cooling system(condenser, evaporator, etc) impurities clean

4	Soldering gun		heating and welding
5	Quick coupling		connection process pipeline, vacuum or charge refrigerant will be used.
6	hand leak detector		welding point leakage detect, if no, use soap-suds

material

No.	Name	Photo	Main Usage
1	Process pipeline		Charge the refrigerant
2	Dry filter		Involving a system failure to be replaced
3	Copper welding rod		tube welding
4	Refrigerant/gas		Add refrigerant to the system

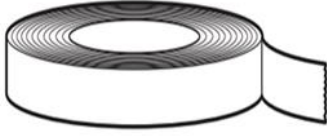
5	Sealing tape		door fixing for reversible door option
---	--------------	---	--

Midea Refrigerators

If you need to get detailed technical information from the manufacturer, please contact:

xxx@midea.com

Refrigeration Division

Overseas Sales Company

Address: No. 176, Jinxiu Avenue, Economic-Technological Development Area, Hefei, Anhui, China