

BEVERAGE INDUSTRY

PARTS MANUAL



ALL PURPOSE COLD

2003

115V/60HZ

220V/60HZ

220V/50HZ

PART	IL - NUMBER	PAGE NUMBER
ACCUMULATOR	IL - 8	1
BALLAST	IL -2,8	1 & 2
BALLAST REPLACEMENT KIT	IL - 2	2
BASE PLATE	IL - 7	2
BASE STAND	IL - 7	2
BODY COVER (SMM10)	IL - 7	2
BOLT- TOP TRACK		3
BOLT-DOOR HINGE	IL - 5	2 & 3
BRACKET-EVAP.FAN MOTOR	IL - 3	4
BRACKET-CONDENSER FAN MOTOR	IL - 9	3
BRACKET-DOOR ROLLER	IL - 4	3 & 4
BRACKET-FOR EVAP. COVER	IL - 9	3
BRACKET-SCREW FOR ROLLER BKT.	IL - 4	4
BREAKER-CABINET	IL - 6	4 & 5
BREAKER-DOOR TRACK-BOTTOM	IL - 6	5
BREAKER-END GLASS-RETAINER	IL - 6	5
BREAKER-LID TRACK		5
BREAKER-POCKET-COVER	IL - 6	5 & 6
BREAKER-TOP TRIM	IL - 6	6
CAP. & RELAY ASSEMBLY	IL - 9	6
CAPACITORS	IL - 9	6
CAPILLARY TUBES	IL - 8	7
CAP-RUBBER STRIP	IL - 1	6
CASTERS	IL - 11	7 & 8
CENTER DOOR BUMPERS	IL - 4	8
CENTER PIPE (SMM10)	IL - 7	8
COLLECTOR-INNER (SMM10)	IL - 7	8
COLLECTOR-OUTER (SMM10)	IL - 7	8
COMPRESSORS	IL - 7,8,9	8 & 9
CONDENSATE PANS	IL - 8,9	9
CONDENSING UNITS	IL - 8	10 & 11
CONDENSOR COILS	IL - 7,8,9	9
CORNER COVER	IL - 6	13
COVER-ASSY-EVAPORATOR	IL - 3	13
CURVE FLOW SHELF KITS	IL - 11	13
DEFROST TIMER (SMM10)	IL - 7	14
DIVIDERS (SMM10)	IL - 7	14
DOOR HANDLE REPLACEMENT KITS (SLIDE DC	IL - 4,5	18
DOOR HANDLE -SCREWS	IL - 5	18
DOOR HANDLE WASHERS	IL - 5	18
DOOR HANDLES	IL - 5	17 & 18
DOOR HINGES	IL - 5	15 & 16
DOOR LOCK KITS	IL - 10	16
DOOR ROLLER-NUT	IL - 4	19
DOOR STOP BUMPERS	IL - 1,4	17
DOOR STOP SCREWS	IL - 1	19
DOOR STOPS	IL - 4,5	16 & 17
DOOR TRACK NUT	IL - 4	19
DOOR TRACKES-TOP	IL - 1	14
DOOR-ROLLER KITS	IL - 4	42 & 43

PART	IL - NUMBER	PAGE NUMBER
DOOR-ROLLER	IL - 4	42
DOORS	IL - 4,5	13 & 14
DRAIN CLAMP (BZ13)		20
DRAIN FLANGE	IL - 3	20
DRAIN FLANGE ADAPTER	IL - 3	20
DRUM ASSY. (SMM10)	IL - 7	20
DRYERS	IL - 7,8	20 & 21
END CAPS	IL - 2	21
EVAP. COVER BRACKET	IL - 3	41
EVAP. COVER RETAINER-SCREW	IL - 3	41
TINNERMAN CLIP	IL - 3	49
EVAP. FAN HOUSINGS	IL - 3	20 & 21
BALLAST REPLACEMENT KIT	IL - 2	23
EVAPORATOR COIL	IL - 7,8,9	21 & 22
FAN BLADES	IL - 3,7,8,9	23 & 24
FAN GUARDS	IL - 3	23
FAN SHROUDS-CONDENSOR	IL - 8	24
SHIELDS (BZ13/16) - FRONT& END	IL - 1	44
GASKETS	IL - 4,5,6	25
GLASS - SLIDE		25
GLIDE MATS	IL - 11	25
GRILL SCREWS		26
GRILLS	IL - 1	26 & 27
HANDLE-ADAPTER		26
HANDLE-NUT	IL - 5	26
HANDLE-REPAIR KITS (SLIDE DOORS)	IL - 4	26
HEAD RAIL REPAIR KITS	IL - 5	26
HEAT EXCHANGER (SMM10)	IL - 7	26
HEATER-TOP (BZ13&16)		26
HOLD DOWN-HOT GAS TUBE		26
HOLD OPEN-HEX NUT	IL - 1	26
HOLD OPEN-PIN	IL - 1	27
HOLD OPEN-SCREW	IL - 1	27
HOLDERS-BOTTLE (EZA84LD)		27
HONEY COMB	IL - 1	27
HOT GAS - LINE	IL - 8	48
LAMP ASSEMBLIES	IL - 2	27,28 & 29
LAMP HOLDERS	IL - 2	29 & 30
LAMP RETAINERS	IL - 3	30 & 31
LAMP SHELDS	IL - 2	31
LAMPS	IL - 2	27
LEG LEVELERS	IL - 11	31 & 32
LEGS	IL - 11	31
LIGHTING UPGRADE (BZ16)	IL - 2	32
LIVE DISPLAY ASSY.		13
METEL-BODY (SMM10)	IL - 7	32
MOTOR SCREWS - EVAP.	IL - 3	34

PART	IL - NUMBER	PAGE NUMBER
MOTORS-EVAP. FAN	<u>IL - 3</u>	<u>33 & 34</u>
MPTORS-CONDENSER FAN	<u>IL - 7,8,9</u>	<u>33 & 34</u>
OVERLOADS	<u>IL - 9</u>	<u>35 & 36</u>
PANS-EVAP DRAIN	<u>IL - 1</u>	<u>36</u>
PILASTER SCREWS		<u>37</u>
PILASTER/ SHELF SUPPORTS	<u>IL - 11</u>	<u>36</u>
REAR ASSEMBLY KIT (MT15)		<u>37</u>
REFRIGERATION ASSEMBLYS	<u>IL - 8,9</u>	<u>37 & 38</u>
RELAYS	<u>IL - 9</u>	<u>38 & 39</u>
REVERSING COND. FAN-KITS	<u>IL - 9</u>	<u>40,41,42 & 43</u>
SHEILD CLAMP (BZ13/16)	<u>IL - 1</u>	<u>44</u>
SHELF CLIPS	<u>IL - 11</u>	<u>43 & 44</u>
SHELF SUPPORTS (UC85)	<u>IL - 11</u>	<u>43</u>
SHELVES	<u>IL - 11</u>	<u>43</u>
SIGN FRAMES	<u>IL - 1</u>	<u>44</u>
SPACER-HINGE (MM UNITS)	<u>IL - 5</u>	<u>44</u>
SPRINGS-SLIDE DOORS	<u>IL - 4,5</u>	<u>44 & 45</u>
SUCTION LINES/CAP TUBE ASSEMBLYS	<u>IL - 8</u>	<u>45 & 46</u>
SWITCHE-FAN/LIGHT	<u>IL - 3</u>	<u>46 & 47</u>
TEMPERATURE CONTROL MOUNTING SCREWS		<u>12 & 13</u>
TEMPERATURE CONTROLS	<u>IL - 3</u>	<u>11 & 12</u>
THERMOMETERS	<u>IL - 3</u>	<u>47</u>
TOP ASSEMBLYS (BX16)		<u>47</u>
TOP TRACK SCREWS		<u>48</u>
WASHER SPACERS	<u>IL - 4,5</u>	<u>48</u>
WASHERS	<u>IL - 4,5</u>	<u>48</u>
WICKING	<u>IL - 8,9</u>	<u>49</u>

TOC III

HOW TO USE THIS MANUAL

- (1) The parts in this manual are listed in alphabetical order and are illustrated on pages IL-1 THRU. IL-11.
- (2) To locate a part you are looking for scroll the Table of Contents (TOC). There you will find the part listed along with the Illustration Page number (IL - 1) and the Page Number where the part can be found,
- (3) When searching for a part please have the serial number of the cabinet for reference. This will insure you will receive the correct parts. Please refer to the serial number chart below.

Note: Most parts are illustrated, some parts are not. However all parts are listed.

SERIAL NUMBER BREAK HISTORY				
	1st Qtr	2nd Qtr	3rd Qtr	4th Qtr
1990	JAN-MAR	MAR-JUNE	JUNE-OCT	OCT-DEC
	13	14	15	16
1991	JAN-MAR	MAR-JUNE	JUNE-OCT	OCT-DEC
	17	18	19	20
1992	JAN-MAR	MAR-JUNE	JUNE-OCT	OCT-DEC
	21	22	23	24
1993	JAN-MAR	MAR-JUNE	JUNE-OCT	OCT-DEC
	25	26	27	28
1994	JAN-MAR	MAR-JUNE	JUNE-OCT	OCT-DEC
	29	30	31	32
1995	JAN-MAR	MAR-JUNE	JUNE-OCT	OCT-DEC
	33	34	35	36
1996	JAN-MAR	MAR-JUNE	JUNE-OCT	OCT-DEC
	37	38	39	41
1997	JAN-MAR	MAR-JUNE	JUNE-OCT	OCT-DEC
	42	43	44	45
1998	JAN-MAR	MAR-JUNE	JUNE-OCT	OCT-DEC
	46	47	48	49
1999	JAN-MAR	MAR-JUNE	JUNE-OCT	OCT-DEC
	50	51	52	53
2000	JAN-MAR	MAR-JUNE	JUNE-OCT	OCT-DEC
	54	55	56	57
2001	JAN-MAR	MAR-JUNE	JUNE-OCT	OCT-DEC
	58	59	60	61
2002	JAN-MAR	MAR-JUNE	JUNE-OCT	OCT-DEC
	62	63	64	65
2003	JAN-MAR	MAR-JUNE	JUNE-OCT	OCT-DEC
	66	67	68	69
2004	JAN-MAR	MAR-JUNE	JUNE-OCT	OCT-DEC
	70	71	72	73
2005	JAN-MAR	MAR-JUNE	JUNE-OCT	OCT-DEC
	74	75	76	77

Note: First two digits represent quarter

From 1981 thru 1985 the first two digits identified the year the unit was manufactured (81 thru 85)

In 1986 the first two digits (40) were used to identify that year.

In 1987 Beverage-Air began utilizing the current system by quarters and skipped the (40) range because that serial range had already been used in 1986.

CABINET COMPONENTS

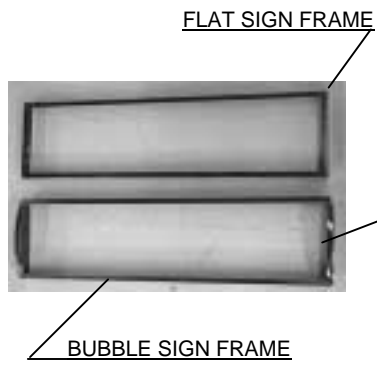

CAP - RUBBER STRIP

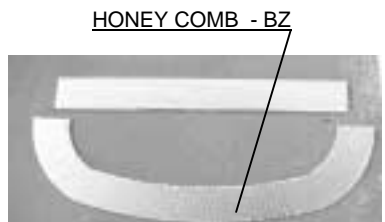
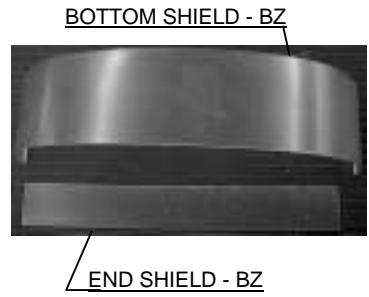

EVAPORATOR DRAIN PAN

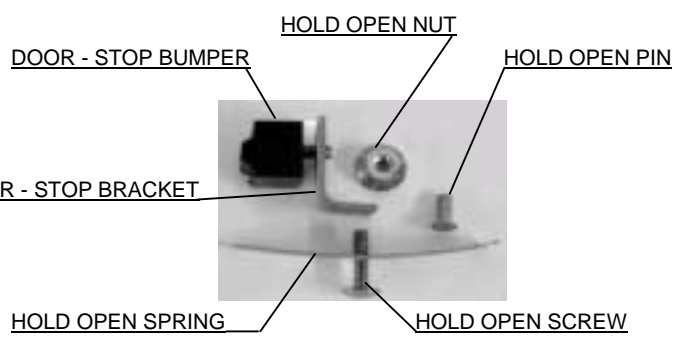

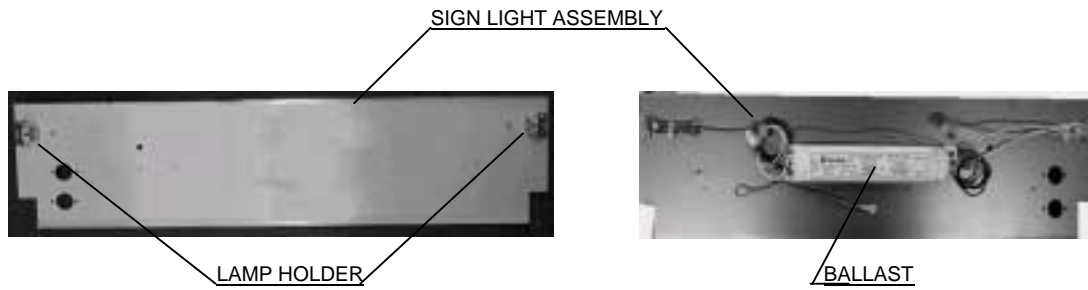

BALLAST REPLACEMENT KIT
NOTE: DOES NOT COME WITH
FAN MOTORS & BLADES

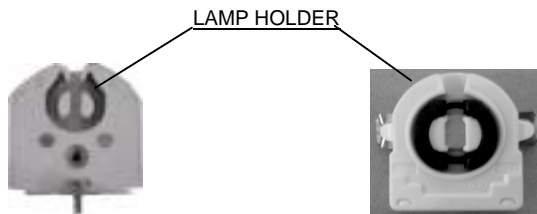

VERTICAL LAMP ASSEMBLY

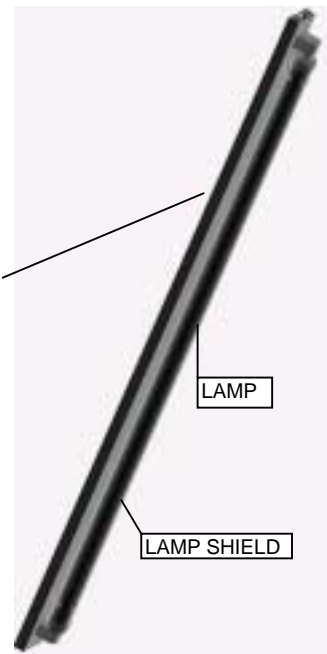

LAMP HOLDER

FAN HOUSINGS

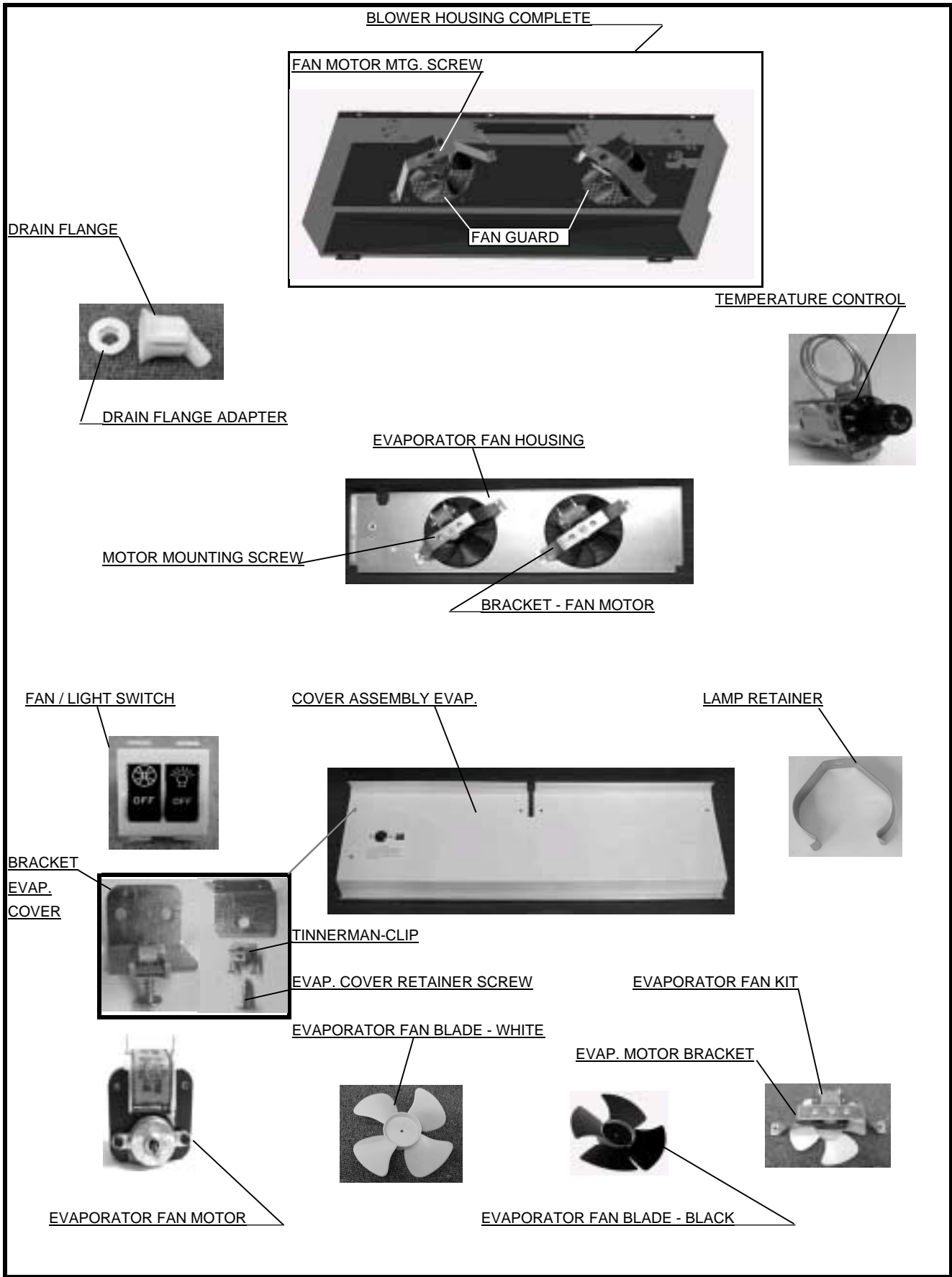

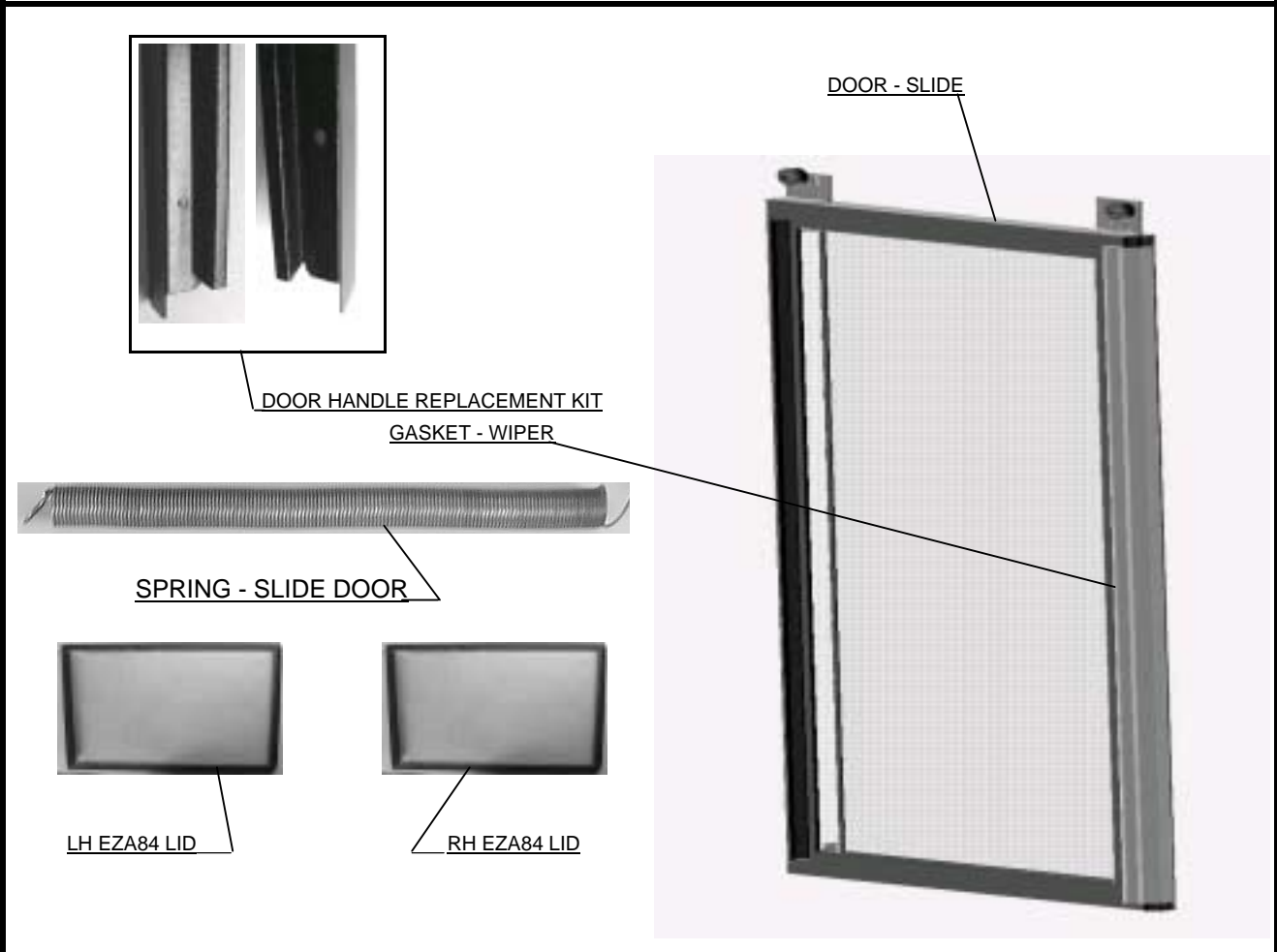
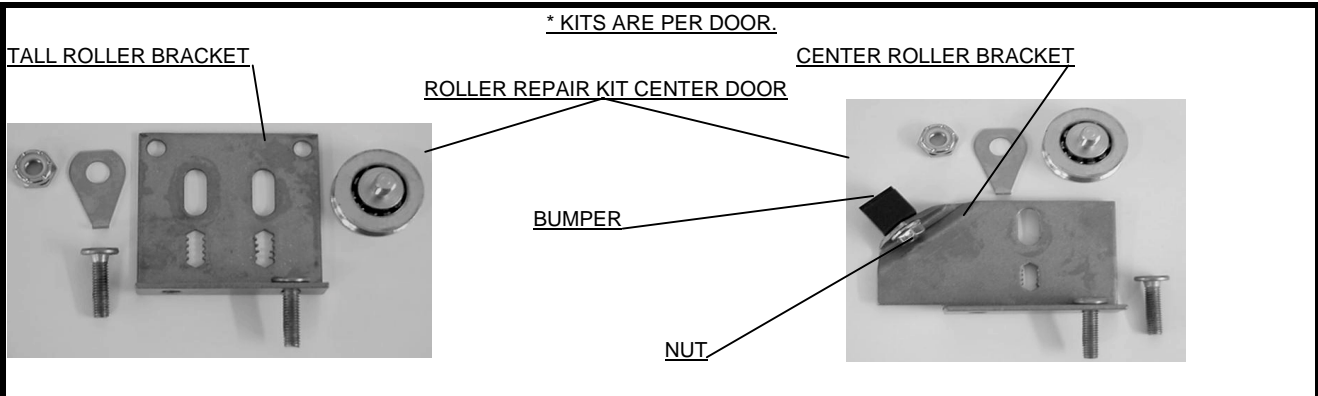

DOORS-SWING

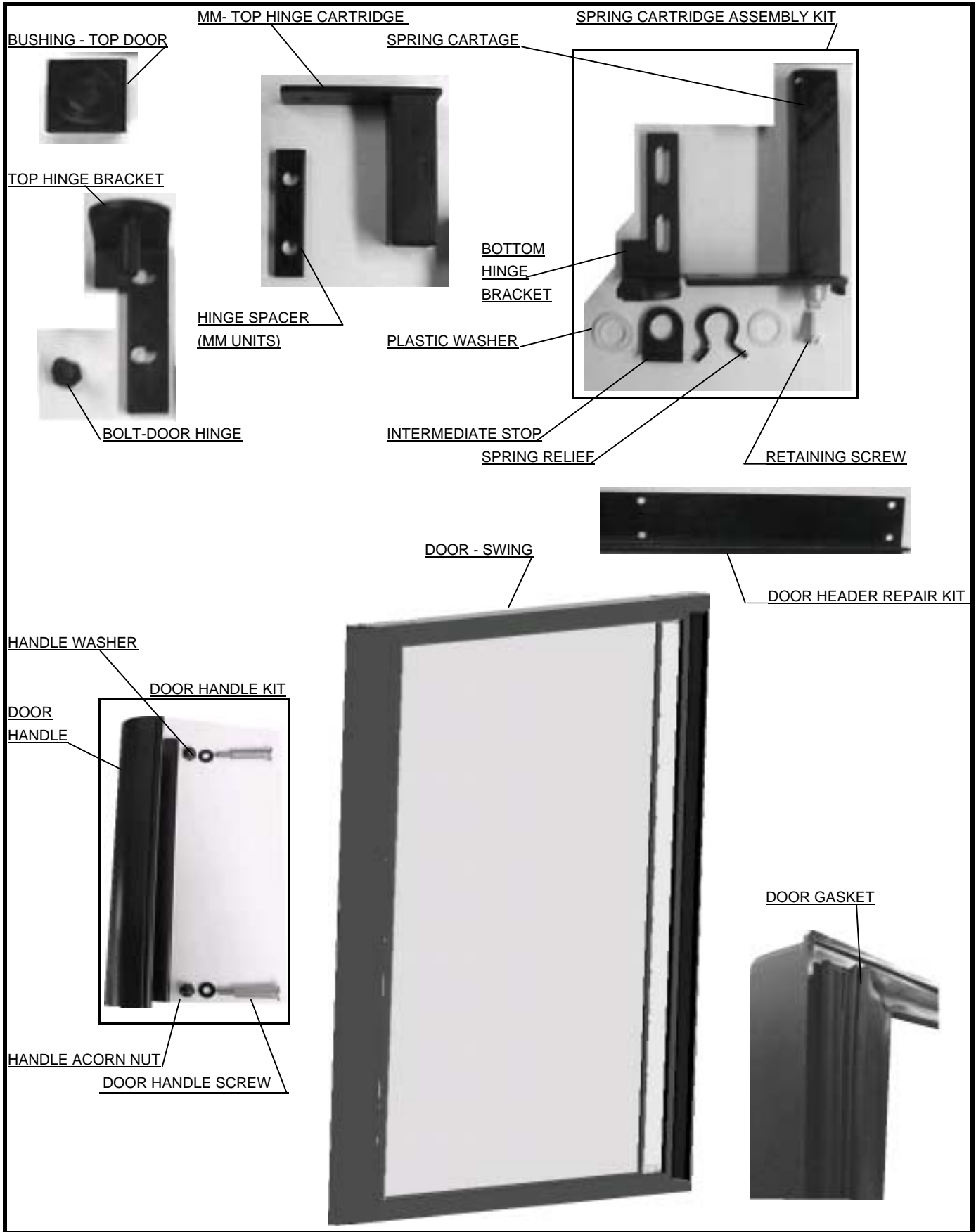

CABINET GASKET



BREAKER - TOP TRIM



BREAKER - CABINET (LEFT SIDE)

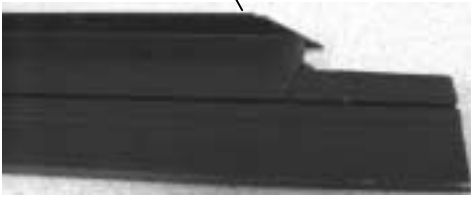

BREAKER - CABINET (RIGHT SIDE)



END GLASS RETAINER

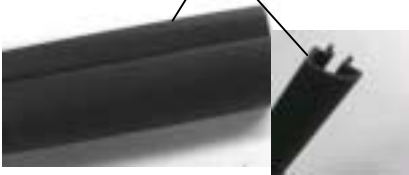

BREAKER - DOOR TRACK-BOTTOM

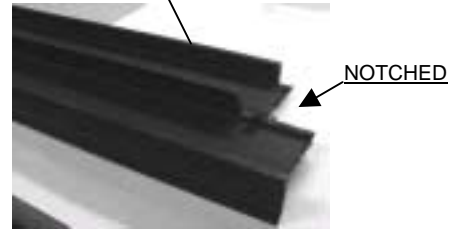

GASKET - TOP TRACK



CORNER CIVER - SLIDE DOOR

BREAKER - POCKET COVER



CORNER COVER - SWING DOOR

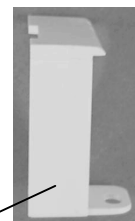

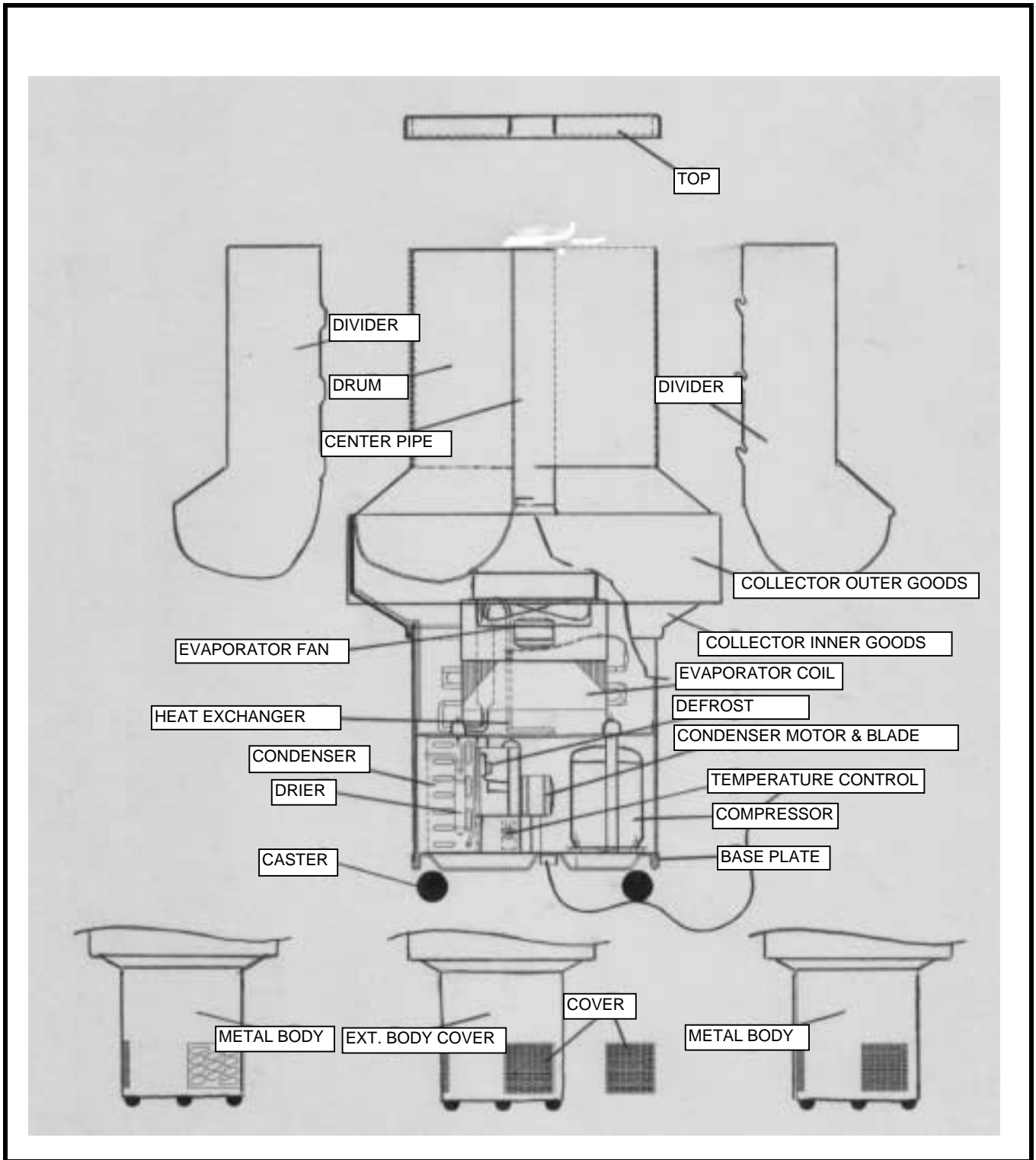

IL - 7

REFRIGERATION ASSEMBLY (COMPLETE)

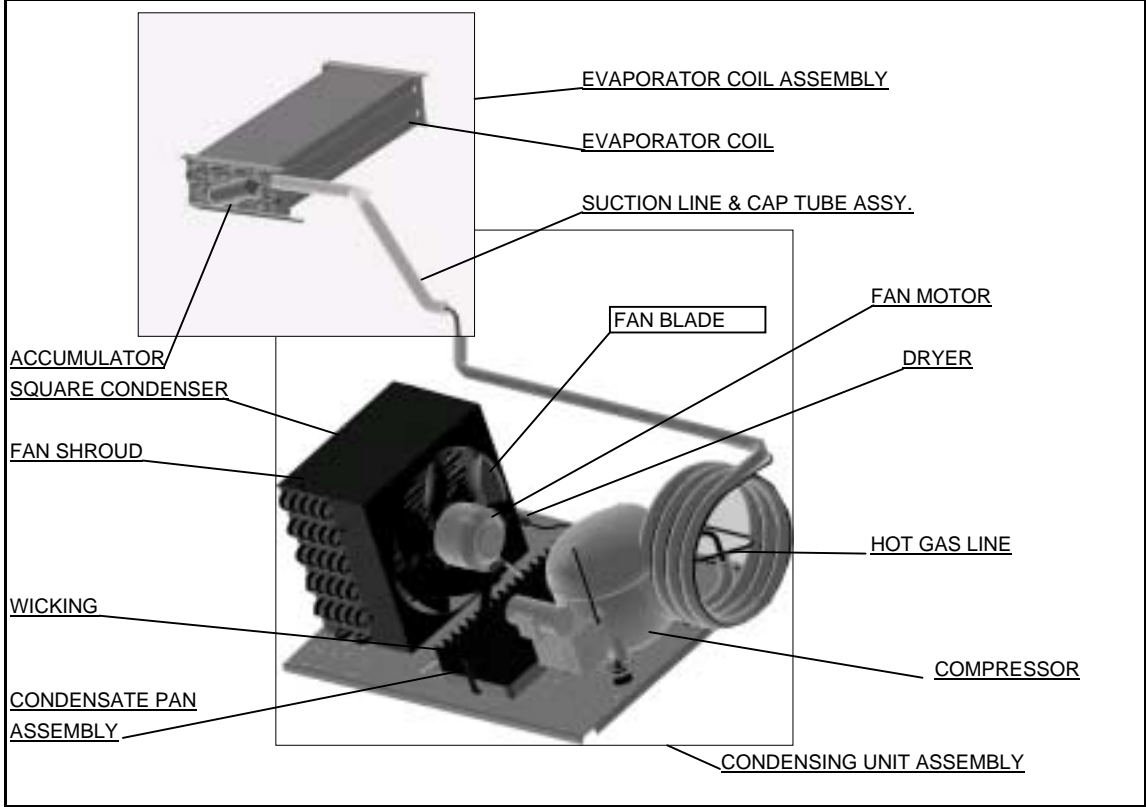

BZ16 REFRIGERATION DECK ASSEMBLY

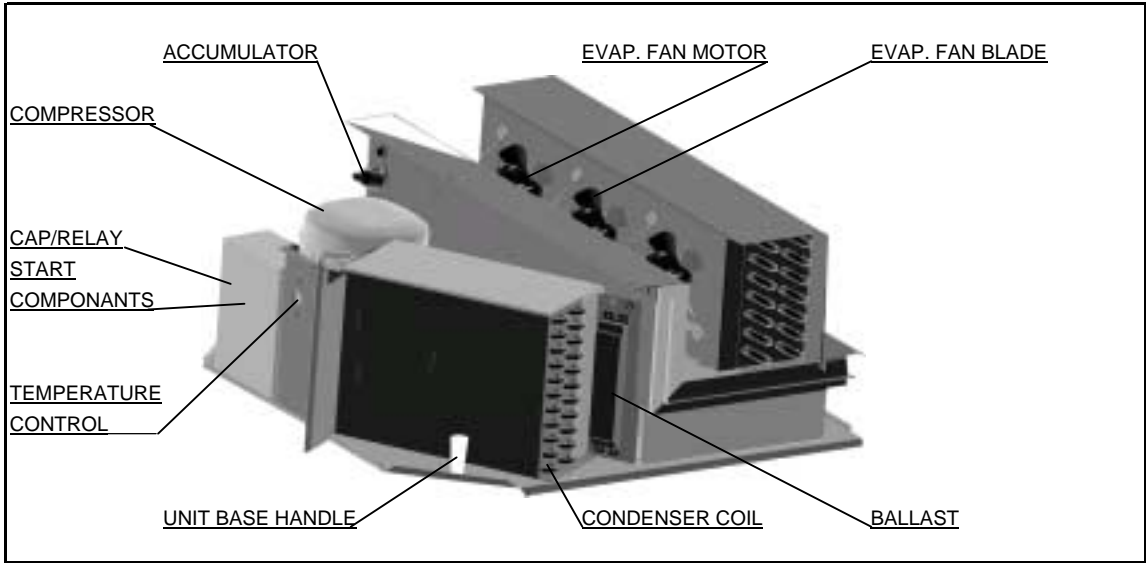

REFRIGERATION

BZ13 REFRIGERATION DECK ASSEMBLY

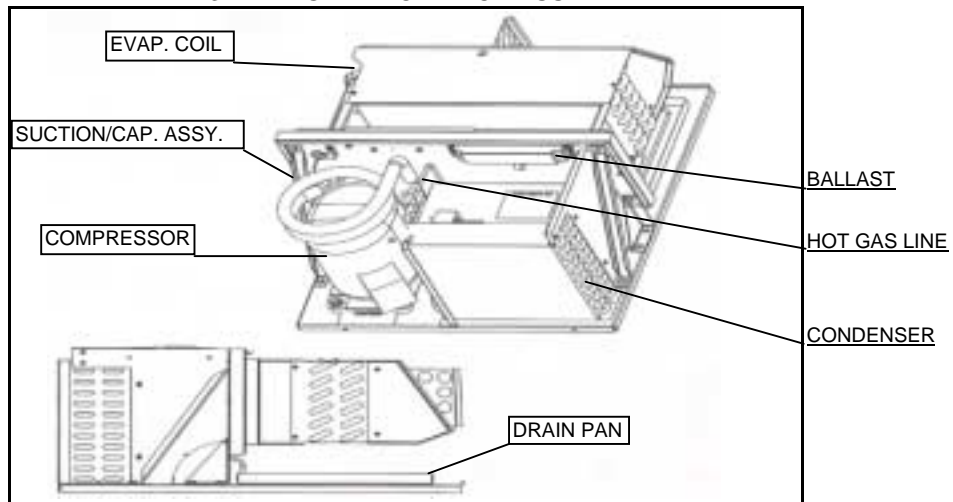

CONDENSING UNIT ASSEMBLY

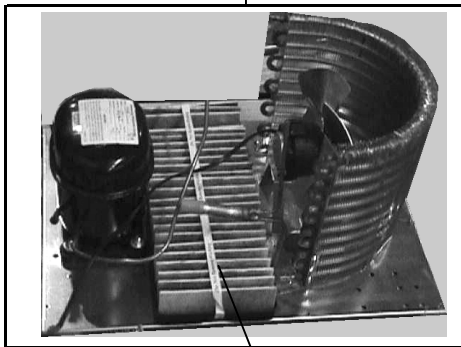

REVERSING CONDENSER FAN KIT



CONDENSATE AIR WICKS

START CAPACITOR.

CAP. & RELAY ASSEMBLY

RUN CAP.

CONDENSER FAN MOTOR

CONDENSER FAN BLADE



RELAY POTENTIAL

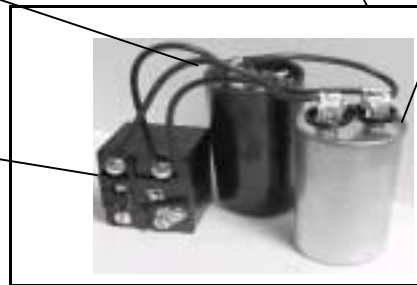
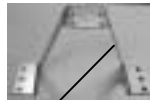

CONDENSER FAN MOTOR BRACKET

CURVED CONDEN

BARE TUBE CONDENSER

SQUARE CONDENSER

CURRENT RELAY

OVERLOAD

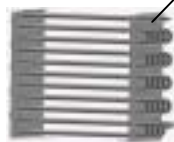

DOOR LOCK KIT MT10/12/14/18/1921/23/27

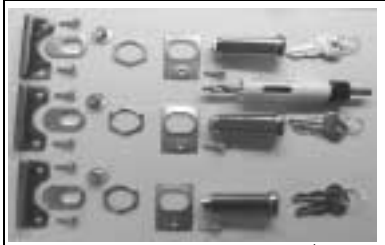

DOOR LOCK KIT MT72



DOOR LOCK KIT MT49



DOOR LOCK KIT MT33/38/45/SLM48



DOOR LOCK KIT MT66

DOOR LOCK KIT MM14

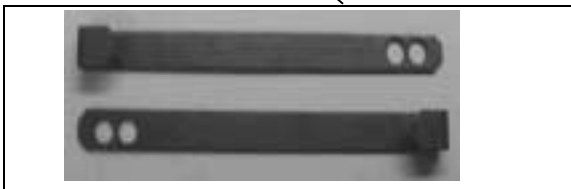

DOOR LOCK KIT MT15/17/19-54



SHELVING - MT

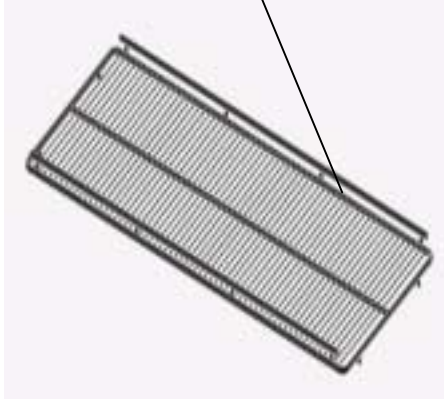

SHELVING - BZ

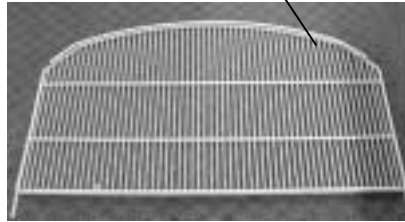

MT GLIDE MAT

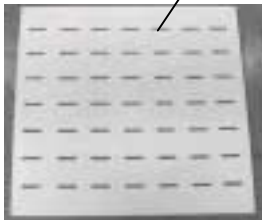

BZ GLIDE MAT

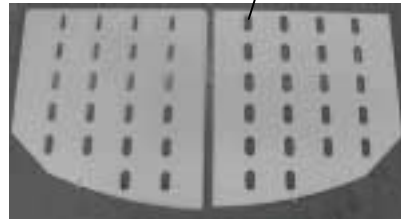

SHELF CLIP



CURVE FLOW ORGANIZER

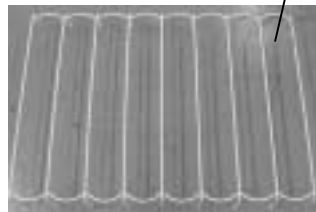

PILASTER SHELF SUPPORTS



CASTER -4 INCH



Caster - 6 inch



LEG



LEVELER

ACCESSORIES

MT23	SHELF CLIP	LONG TAB	403-306A	1300860 THRU CURRENT
MT27	SHELF CLIP	SHORT TAB	403-168A	1300860 THRU CURRENT
MT27	SHELF CLIP	LONG TAB	403-306A	1300860 THRU CURRENT
MT33	SHELF CLIP	SHORT TAB	403-168A	1300860 THRU CURRENT
MT33	SHELF CLIP	LONG TAB	403-306A	1300860 THRU CURRENT
MT35	SHELF CLIP	SHORT TAB	403-168A	1300860 THRU CURRENT
MT35	SHELF CLIP	LONG TAB	403-306A	1300860 THRU CURRENT
MT38	SHELF CLIP	SHORT TAB	403-168A	1300860 THRU CURRENT
MT38	SHELF CLIP	LONG TAB	403-306A	1300860 THRU CURRENT
MT45	SHELF CLIP	SHORT TAB	403-168A	1300860 THRU CURRENT
MT45	SHELF CLIP	LONG TAB	403-306A	1300860 THRU CURRENT
MT49	SHELF CLIP	SHORT TAB	403-168A	1300860 THRU CURRENT
MT49	SHELF CLIP	LONG TAB	403-306A	1300860 THRU CURRENT
MT66	SHELF CLIP	SHORT TAB	403-168A	1300860 THRU CURRENT
MT66	SHELF CLIP	LONG TAB	403-306A	1300860 THRU CURRENT
MT72	SHELF CLIP	SHORT TAB	403-168A	1300860 THRU CURRENT
MT72	SHELF CLIP	LONG TAB	403-306A	1300860 THRU CURRENT
UR20	SHELF CLIP	SHORT TAB	403-168A	1300860 THRU CURRENT
UR30	SHELF CLIP	SHORT TAB	403-168A	1300860 THRU CURRENT
BZ13	SHIELD	END PLEXIGLAS L&R	706-163D-01	3441092 THRU CURRENT
BZ13	SHIELD	FRONT PLEXIGLAS - BOTTOM	706-164D-01	3441092 THRU CURRENT
BZ16	SHIELD	END PLEXIGLAS L&R	706-090D	3441092 THRU CURRENT
BZ16	SHIELD	FRONT PLEXIGLAS - BOTTOM	706-091D	3441092 THRU CURRENT
BZ13	SHIELD CLAMP	CHROME - 2 PER UNIT	605-049A	3441092 THRU CURRENT
BZ16	SHIELD CLAMP	CHROME - 2 PER UNIT	605-049A	3441092 THRU CURRENT
MT38	SIGN FRAME	BUBBLE 43 1/4" X 9 13/16"	50B32-065C	0103159 THRU CURRENT
MT66	SIGN FRAME	FLAT 74 1/2" X 8 11/16"	50B32-050C	8123598 THRU CURRENT
SLM48	SIGN FRAME	FLAT 47 3/16" X 8 11/16"	50B32-060C	8123598 THRU CURRENT
MM27	SIGN FRAME	CURVED 29 1/4" X 8 3/4"	706-061D-01	3441092 THRU CURRENT
MT27	SIGN FRAME	BUBBLE 29 13/16" X 8 3/4"	50B32-063C	0108003 THRU CURRENT
MT33	SIGN FRAME	BUBBLE 38 13/16" X 9 13/16"	50B32-064C	0108003 THRU CURRENT
MT35	SIGN FRAME	BUBBLE 38 11/32" X 8 11/16"	50B32-099C-01	1998 THRU CURRENT
MT35	SIGN FRAME	FLAT 38 11/32" X 8 11/16"	50B32-101D-01	1998 THRU CURRENT
MT45	SIGN FRAME	BUBBLE 51 3/4" X 9 13/16"	50B32-066C	0108003 THRU CURRENT
BZ13	SIGN FRAME	LENS ASSEMBLY	50B32-109D-01	3441092 THRU CURRENT
BZ13	SIGN FRAME	LENS ASSEMBLY	50B32-109D-01	3441092 THRU CURRENT
MT38	SIGN FRAME	FLAT 42 7/8" X 8 11/16"	50B32-047C	8123598 THRU CURRENT
MT72	SIGN FRAME	FLAT 74 1/2" X 8 11/16"	50B32-051C	8123598 THRU CURRENT
MT45	SIGN FRAME	FLAT 51 3/8" X 8 11/16"	50B32-048C	8123598 THRU CURRENT
MT49	SIGN FRAME	FLAT 51 3/8" X 8 11/16"	50B32-049C	8123598 THRU CURRENT
MT49	SIGN FRAME	BUBBLE 51 3/4" X 8 3/4"	50B32-067C	0108003 THRU CURRENT
MT21	SIGN FRAME	BUBBLE 27 1/16" X 8 3/4"	50B32-062C	0108003 THRU CURRENT
MT23	SIGN FRAME	BUBBLE 27 1/16" X 8 3/4"	50B32-062C	1987 THRU CURRENT
MT66	SIGN FRAME	BUBBLE 74 7/8" X 9 13/16"	50B32-068C	0108003 THRU CURRENT
MT72	SIGN FRAME	BUBBLE 74 7/8" X 9 13/16"	50B32-068C	0108003 THRU CURRENT
MT19	SIGN FRAME	BUBBLE 23 3/8" X 6 3/4"	50B32-091D-01	1996 THRU CURRENT
MT21	SIGN FRAME	FLAT 26 11/16" X 8 11/16"	50B32-044C	8123598 THRU CURRENT
MT23	SIGN FRAME	FLAT 26 11/16" X 8 11/16"	50B32-044C	1987 THRU CURRENT
MT27	SIGN FRAME	FLAT 29 7/16" X 8 11/16"	50B32-045C	8123598 THRU CURRENT
MT19	SIGN FRAME	FLAT 23 3/8" X 6 3/4"	50B32-089D-01	8123598 THRU CURRENT
MT33	SIGN FRAME	FLAT 38 7/16" X 8 11/16"	50B32-046C	8123598 THRU CURRENT
MM14	SPACER	TOP & BOTTOM (HINGE)	401-572A-02	3441092 THRU CURRENT
MM27	SPACER	TOP & BOTTOM (HINGE)	401-572A-02	3441092 THRU CURRENT
EZA84	SPRING	PRODUCT DIVIDER	401-090AAB	3441092 THRU CURRENT
MT ALL	SPRING	WICKING RETAINING	401-113AAC	3133015 THRU CURRENT
MM14	SPRING - CARTRIDGE	TOP - BLACK LEFT & RIGHT	401-571A-02	8123598 THRU CURRENT
MM27	SPRING - CARTRIDGE	TOP - BLACK LEFT & RIGHT	401-571A-02	8123598 THRU CURRENT
MT10	SPRING - CARTRIDGE	BOTTOM - BLACK LEFT & RIGHT	401-600A-02	8123598 THRU CURRENT
MT12	SPRING - CARTRIDGE	BOTTOM - BLACK LEFT & RIGHT	401-600A-02	8123598 THRU CURRENT
MT14	SPRING - CARTRIDGE	BOTTOM - BLACK LEFT & RIGHT	401-216A-02	8123598 THRU CURRENT
MT18	SPRING - CARTRIDGE	BOTTOM - BLACK LEFT & RIGHT	401-216A-02	8123598 THRU CURRENT

ACCESSORIES

MT19	SPRING - CARTRIDGE	BOTTOM - BLACK LEFT & RIGHT	401-600A-02	8123598 THRU CURRENT
MT21	SPRING - CARTRIDGE	BOTTOM - BLACK LEFT & RIGHT	401-216A-02	8123598 THRU CURRENT
MT23	SPRING - CARTRIDGE	BOTTOM - BLACK LEFT & RIGHT	401-216A-02	8123598 THRU CURRENT
MT27	SPRING - CARTRIDGE	BOTTOM - BLACK LEFT & RIGHT	401-216A-02	8123598 THRU CURRENT
MT49	SPRING - CARTRIDGE	BOTTOM - BLACK LEFT & RIGHT	401-216A-02	8123598 THRU CURRENT
MT72	SPRING - CARTRIDGE	BOTTOM - BLACK LEFT & RIGHT	401-263A-02	8123598 THRU CURRENT
UR20	SPRING - CARTRIDGE	BOTTOM - BLACK LEFT & RIGHT	401-454A-02	1304468 THRU CURRENT
UR30	SPRING - CARTRIDGE	BOTTOM - BLACK LEFT & RIGHT	401-454A-02	1304468 THRU CURRENT
MT15	SPRING - DOOR	SLIDE DOOR - 9-1/2" INCHES LONG	401-559B	8123598 THRU CURRENT
MT17	SPRING - DOOR	SLIDE DOOR - 9-1/2" INCHES LONG	401-559B	8123598 THRU CURRENT
MT19-54	SPRING - DOOR	SLIDE DOOR - 9-1/2" INCHES LONG	401-559B	8123598 THRU CURRENT
MT20	SPRING - DOOR	SLIDE DOOR - 9-1/2" INCHES LONG	401-559B	8123598 THRU CURRENT
MT22	SPRING - DOOR	SLIDE DOOR - 9-1/2" INCHES LONG	401-559B	8123598 THRU CURRENT
MT33	SPRING - DOOR	SLIDE DOOR - 8-1/2" INCHES LONG	401-560B	8123598 THRU CURRENT
MT38	SPRING - DOOR	SLIDE DOOR - 9-1/2" INCHES LONG	401-559B	8123598 THRU CURRENT
MT45	SPRING - DOOR	SLIDE DOOR - 11" INCHES LONG	401-561B	8123598 THRU CURRENT
MT66	SPRING - DOOR	SLIDE DOOR - 11" INCHES LONG	401-561B	8123598 THRU CURRENT
SLM48	SPRING - DOOR	SLIDE DOOR - 11" INCHES LONG	401-561B	8123598 THRU CURRENT
EZA84	SPRING - HOOK	SPRING BLOCK	401-663B	3441092 THRU CURRENT
MM14	SPRING - RELIEF	SWING DOOR BOTTOM - HORSE SHOE	401-217A	8123598 THRU CURRENT
MM27	SPRING - RELIEF	SWING DOOR BOTTOM - HORSE SHOE	401-217A	8123598 THRU CURRENT
MT10	SPRING - RELIEF	SWING DOOR BOTTOM - HORSE SHOE	401-217A	8123598 THRU CURRENT
MT12	SPRING - RELIEF	SWING DOOR BOTTOM - HORSE SHOE	401-217A	8123598 THRU CURRENT
MT14	SPRING - RELIEF	SWING DOOR BOTTOM - HORSE SHOE	401-217A	8123598 THRU CURRENT
MT18	SPRING - RELIEF	SWING DOOR BOTTOM - HORSE SHOE	401-217A	8123598 THRU CURRENT
MT19	SPRING - RELIEF	SWING DOOR BOTTOM - HORSE SHOE	401-217A	8123598 THRU CURRENT
MT21	SPRING - RELIEF	SWING DOOR BOTTOM - HORSE SHOE	401-217A	8123598 THRU CURRENT
MT23	SPRING - RELIEF	SWING DOOR BOTTOM - HORSE SHOE	401-217A	8123598 THRU CURRENT
MT27	SPRING - RELIEF	SWING DOOR BOTTOM - HORSE SHOE	401-217A	8123598 THRU CURRENT
MT49	SPRING - RELIEF	SWING DOOR BOTTOM - HORSE SHOE	401-217A	8123598 THRU CURRENT
MT72	SPRING - RELIEF	SWING DOOR BOTTOM - HORSE SHOE	401-217A	8123598 THRU CURRENT
UR20	SPRING - RELIEF	SWING DOOR BOTTOM - HORSE SHOE	401-217A	1304468 THRU CURRENT
UR30	SPRING - RELIEF	SWING DOOR BOTTOM - HORSE SHOE	401-217A	1304468 THRU CURRENT
BZ16	START CAPACITOR	72-88 MFD@330V 220V/60HZ	302-425A	3133015 THRU CURRENT
BZ16	START CAPACITOR	72-88 MFD@330V 220V/50HZ	302-425A	3133015 THRU CURRENT
MM27	START CAPACITOR	47-56 MFD@230V A54 220V/60HZ	302-711A	3133015 THRU CURRENT
MT15	START CAPACITOR	47-56 MFD@230V A54 220V/60HZ	302-711A	3133015 THRU CURRENT
MT15-54	START CAPACITOR	47-56 MFD@230V A54 220V/60HZ	302-711A	3133015 THRU CURRENT
MT17	START CAPACITOR	47-56 MFD@230V A54 220V/60HZ	302-711A	3133015 THRU CURRENT
MT17-54	START CAPACITOR	47-56 MFD@230V A54 220V/60HZ	302-711A	3133015 THRU CURRENT
MT21	START CAPACITOR	47-56 MFD@230V A54 220V/60HZ	302-711A	3133015 THRU CURRENT
MT23	START CAPACITOR	47-56 MFD@230V A54 220V/60HZ	302-711A	3133015 THRU CURRENT
MT27	START CAPACITOR	47-56 MFD@230V A54 220V/60HZ	302-711A	3133015 THRU CURRENT
MT33	START CAPACITOR	135/155 MFD@250V 220V/60HZ	302-354A	3133015 THRU CURRENT
MT35	START CAPACITOR	135/155 MFD@250V 220V/60HZ	302-354A	3133015 THRU CURRENT
MT38	START CAPACITOR	135/155 MFD@250V 220V/60HZ	302-354A	3133015 THRU CURRENT
MT45	START CAPACITOR	135/155 MFD@250V 220V/60HZ	302-354A	3133015 THRU CURRENT
MT49	START CAPACITOR	135/155 MFD@250V 220V/60HZ	302-354A	3133015 THRU CURRENT
MT66	START CAPACITOR	72-88 MFD@330V 220V/60HZ	302-425A	3133015 THRU CURRENT
MT66	START CAPACITOR	72-88MFD @ 330V 220V/50HZ	302-425A	3133015 THRU CURRENT
MT72	START CAPACITOR	72-88 MFD@330V 220V/60HZ	302-425A	3133015 THRU CURRENT
MT72	START CAPACITOR	72-88MFD @ 330V 220V/50HZ	302-425A	3133015 THRU CURRENT
SLM48	START CAPACITOR	135/155 MFD@250V 220V/60HZ	302-354A	3133015 THRU CURRENT
SLM48	START CAPACITOR	135-155MFD @ 250V 220V/50HZ	302-354A	3133015 THRU CURRENT
BZ13	SUCTION LINE	ASSEMBLY	49B30-323D-01	3133015 THRU CURRENT
BZ13	SUCTION LINE	ASSEMBLY	49A30-371C-42	3133015 THRU CURRENT
EZA84	SUCTION LINE	ASSEMBLY	19B30-054D	3133015 THRU CURRENT
UR30	SUCTION LINE & CAP. TUBE	ASSEMBLY	19C30-017D	3111474 THRU 4303134
UR20	SUCTION LINE/CAP TUBE	ASSEMBLY	19B30-017D	3111474 THRU 4303134
BZ16	SUCTION LINE/CAP TUBE	ASSEMBLY	49B30-293D	3133015 THRU CURRENT
EZA84	SUCTION LINE/CAP TUBE	ASSEMBLY	19B30-054D	4303135 THRU CURRENT

ACCESSORIES

MM14	SUCTION LINE/CAP TUBE	ASSEMBLY	49B30-222D	4303135 THRU CURRENT
MM27	SUCTION LINE/CAP TUBE	ASSEMBLY	49B30-216D	4303135 THRU CURRENT
MT10	SUCTION LINE/CAP TUBE	ASSEMBLY	49B30-317A	4303135 THRU CURRENT
MT12	SUCTION LINE/CAP TUBE	ASSEMBLY	49B30-181D	THRU 3223900
MT12	SUCTION LINE/CAP TUBE	ASSEMBLY	49B30-238D	3223901 THRU CURRENT
MT14	SUCTION LINE/CAP TUBE	ASSEMBLY	49B30-238D	3223901 THRU CURRENT
MT15	SUCTION LINE/CAP TUBE	ASSEMBLY	49B30-192D	THRU 3140800
MT15	SUCTION LINE/CAP TUBE	ASSEMBLY	49B30-210D	3140801 THRU 4879791
MT15	SUCTION LINE/CAP TUBE	ASSEMBLY	49B30-302D	4879792 THRU CURRENT
MT15-54	SUCTION LINE/CAP TUBE	ASSEMBLY	49B30-179D	THRU 3140800
MT15-54	SUCTION LINE/CAP TUBE	ASSEMBLY	49B30-200D	4879792 THRU CURRENT
MT17	SUCTION LINE/CAP TUBE	ASSEMBLY	49B30-045C	0108003 THRU 4879520
MT17	SUCTION LINE/CAP TUBE	ASSEMBLY	49B30-208D	THRU 3134763
MT17-54	SUCTION LINE/CAP TUBE	ASSEMBLY	49B30-173D	0108003 THRU 3134763
MT17-54	SUCTION LINE/CAP TUBE	ASSEMBLY	49B30-201D	3134764 THRU CURRENT
MT18	SUCTION LINE/CAP TUBE	ASSEMBLY	49B30-046C	0108003 THRU 3201506
MT18	SUCTION LINE/CAP TUBE	ASSEMBLY	49B30-195C	3201507 THRU CURRENT
MT19	SUCTION LINE/CAP TUBE	ASSEMBLY	49B30-282D	4303135 THRU CURRENT
MT19-54	SUCTION LINE/CAP TUBE	ASSEMBLY	49B30-237D	4303135 THRU CURRENT
MT20-54	SUCTION LINE/CAP TUBE	ASSEMBLY	49B30-200D	4303135 THRU CURRENT
MT21	SUCTION LINE/CAP TUBE	ASSEMBLY	49B30-062D	0108003 THRU 1306138
MT21	SUCTION LINE/CAP TUBE	ASSEMBLY	49B30-125D	1306139 THRU 3135463
MT21	SUCTION LINE/CAP TUBE	ASSEMBLY	49B30-204D	3135464 THRU CURRENT
MT22	SUCTION LINE/CAP TUBE	ASSEMBLY	49B30-225D	4303135 THRU CURRENT
MT23	SUCTION LINE/CAP TUBE	ASSEMBLY	49B30-308D	4303135 THRU CURRENT
MT27	SUCTION LINE/CAP TUBE	ASSEMBLY	49B30-070D	0108003 THRU 1306138
MT27	SUCTION LINE/CAP TUBE	ASSEMBLY	49B30-137D	1306139 THRU 3133014
MT33	SUCTION LINE/CAP TUBE	ASSEMBLY	49B30-063D	0108003 THRU 1306138
MT33	SUCTION LINE/CAP TUBE	ASSEMBLY	49B30-126D	1306139 THRU 3129274
MT33	SUCTION LINE/CAP TUBE	ASSEMBLY	49B30-196D	3129175 THRU CURRENT
MT35	SUCTION LINE/CAP TUBE	ASSEMBLY	49B30-290D	4303135 THRU CURRENT
MT38	SUCTION LINE/CAP TUBE	ASSEMBLY	49B30-029C	8123598 THRU 0108002
MT38	SUCTION LINE/CAP TUBE	ASSEMBLY	49B30-068D	0108003 THRU 1306138
MT38	SUCTION LINE/CAP TUBE	ASSEMBLY	49B30-127D	1306139 THRU 3132180
MT38	SUCTION LINE/CAP TUBE	ASSEMBLY	49B30-197D	3132181 THRU CURRENT
MT45	SUCTION LINE/CAP TUBE	ASSEMBLY	49B30-029C	8123598 THRU 0108002
MT45	SUCTION LINE/CAP TUBE	ASSEMBLY	49B30-118D	0108003 THRU 1306138
MT45	SUCTION LINE/CAP TUBE	ASSEMBLY	49B30-128D	1306139 THRU 3124716
MT45	SUCTION LINE/CAP TUBE	ASSEMBLY	49B30-198D	3124717 THRU CURRENT
MT49	SUCTION LINE/CAP TUBE	ASSEMBLY	49B30-029C	8123598 THRU 0108002
MT49	SUCTION LINE/CAP TUBE	ASSEMBLY	49B30-118D	0108003 THRU 1306138
MT49	SUCTION LINE/CAP TUBE	ASSEMBLY	49B30-128D	1306139 THRU 3124716
MT49	SUCTION LINE/CAP TUBE	ASSEMBLY	49B30-198D	3124717 THRU CURRENT
MT66	SUCTION LINE/CAP TUBE	ASSEMBLY	49B30-129D	1306139 THRU CURRENT
MT72	SUCTION LINE/CAP TUBE	ASSEMBLY	49B30-129D	1306139 THRU CURRENT
SLM48	SUCTION LINE/CAP TUBE	ASSEMBLY	49B30-154D	2112810 THRU 3129830
SLM48	SUCTION LINE/CAP TUBE	ASSEMBLY	49B30-199D	3129830 THRU CURRENT
UR20	SUCTION LINE/CAP TUBE	ASSEMBLY	19C30-017D	3111474 THRU 4303134
UR30	SUCTION LINE/CAP TUBE	ASSEMBLY	19B30-048D	4303135 THRU CURRENT
UR20	SWITCH	PUSH LIGHT	502-042A--	1306140 THRU CURRENT
UR30	SWITCH	PUSH LIGHT	502-042A--	1306140 THRU CURRENT
MT10	SWITCH	LIGHT & DEFOG	502-068A	1306140 THRU CURRENT
MT12	SWITCH	LIGHT & DEFOG	502-068A	1306140 THRU CURRENT
MT14	SWITCH	LIGHT & DEFOG	502-068A	1306140 THRU CURRENT
MT15	SWITCH	LIGHT & DEFOG	502-068A	1306140 THRU CURRENT
MT15-54	SWITCH	LIGHT & DEFOG	502-068A	1306140 THRU CURRENT
MT17	SWITCH	LIGHT & DEFOG	502-068A	1306140 THRU CURRENT
MT17-54	SWITCH	LIGHT & DEFOG	502-068A	1306140 THRU CURRENT
MT18	SWITCH	LIGHT & DEFOG	502-068A	1306140 THRU CURRENT
MT19	SWITCH	LIGHT & DEFOG	502-068A	1306140 THRU CURRENT
MT19-54	SWITCH	LIGHT & DEFOG	502-068A	1306140 THRU CURRENT

ACCESSORIES

MT21	SWITCH	LIGHT & DEFOG	502-068A	1306140 THRU CURRENT
MT23	SWITCH	LIGHT & DEFOG	502-068A	1306140 THRU CURRENT
MT27	SWITCH	LIGHT & DEFOG	502-068A	1306140 THRU CURRENT
MT33	SWITCH	LIGHT & DEFOG	502-068A	1306140 THRU CURRENT
MT35	SWITCH	LIGHT & DEFOG	502-068A	1306140 THRU CURRENT
MT38	SWITCH	LIGHT & DEFOG	502-068A	1306140 THRU CURRENT
MT45	SWITCH	LIGHT & DEFOG	502-068A	1306140 THRU CURRENT
MT49	SWITCH	LIGHT & DEFOG	502-068A	1306140 THRU CURRENT
MT66	SWITCH	LIGHT & DEFOG	502-068A	1306140 THRU CURRENT
MT72	SWITCH	LIGHT & DEFOG	502-068A	1306140 THRU CURRENT
SLM48	SWITCH	LIGHT & DEFOG	502-068A	1306140 THRU CURRENT
BZ13	THERMOMETER	VERTICAL	402-223B	1306140 THRU CURRENT
BZ16	THERMOMETER	VERTICAL	402-223B	1306140 THRU CURRENT
MT10	THERMOMETER	VERTICAL	402-223B	1306140 THRU CURRENT
MT12	THERMOMETER	VERTICAL	402-223B	1306140 THRU CURRENT
MT14	THERMOMETER	VERTICAL	402-223B	1306140 THRU CURRENT
MT15	THERMOMETER	VERTICAL	402-223B	1306140 THRU CURRENT
MT15-54	THERMOMETER	VERTICAL	402-223B	1306140 THRU CURRENT
MT17	THERMOMETER	VERTICAL	402-223B	1306140 THRU CURRENT
MT17-54	THERMOMETER	VERTICAL	402-223B	1306140 THRU CURRENT
MT18	THERMOMETER	VERTICAL	402-223B	1306140 THRU CURRENT
MT19	THERMOMETER	VERTICAL	402-223B	1306140 THRU CURRENT
MT19-54	THERMOMETER	VERTICAL	402-223B	1306140 THRU CURRENT
MT21	THERMOMETER	VERTICAL	402-223B	1306140 THRU CURRENT
MT23	THERMOMETER	VERTICAL	402-223B	1306140 THRU CURRENT
MT27	THERMOMETER	VERTICAL	402-223B	1306140 THRU CURRENT
MT33	THERMOMETER	VERTICAL	402-223B	1306140 THRU CURRENT
MT35	THERMOMETER	VERTICAL	402-223B	1306140 THRU CURRENT
MT38	THERMOMETER	VERTICAL	402-223B	1306140 THRU CURRENT
MT45	THERMOMETER	VERTICAL	402-223B	1306140 THRU CURRENT
MT49	THERMOMETER	VERTICAL	402-223B	1306140 THRU CURRENT
MT66	THERMOMETER	VERTICAL	402-223B	1306140 THRU CURRENT
MT72	THERMOMETER	VERTICAL	402-223B	1306140 THRU CURRENT
SLM48	THERMOMETER	VERTICAL	402-223B	1306140 THRU CURRENT
UR20	THERMOMETER	VERTICAL	402-223B	1306140 THRU CURRENT
UR30	THERMOMETER	VERTICAL	402-223B	1306140 THRU CURRENT
MT21	TINNERMAN - CLIP	FOR EVAP. COVER	604-225A	6466174 THRU CURRENT
MT23	TINNERMAN - CLIP	FOR EVAP. COVER	604-225A	6466174 THRU CURRENT
MT27	TINNERMAN - CLIP	FOR EVAP. COVER	604-225A	6466174 THRU CURRENT
MT33	TINNERMAN - CLIP	FOR EVAP. COVER	604-225A	6466174 THRU CURRENT
MT35	TINNERMAN - CLIP	FOR EVAP. COVER	604-225A	6466174 THRU CURRENT
MT38	TINNERMAN - CLIP	FOR EVAP. COVER	604-225A	6466174 THRU CURRENT
MT45	TINNERMAN - CLIP	FOR EVAP. COVER	604-225A	6466174 THRU CURRENT
MT49	TINNERMAN - CLIP	FOR EVAP. COVER	604-225A	6466174 THRU CURRENT
MT66	TINNERMAN - CLIP	FOR EVAP. COVER	604-225A	6466174 THRU CURRENT
MT72	TINNERMAN - CLIP	FOR EVAP. COVER	604-225A	6466174 THRU CURRENT
SLM48	TINNERMAN - CLIP	FOR EVAP. COVER	604-225A	6466174 THRU CURRENT
BZ16	TOP	TOP ASSEMBLY - RED	46B31-081D-20	3441092 THRU CURRENT
BZ16	TOP	TOP ASSEMBLY- IVORY	46B31-081D-02	3441092 THRU CURRENT
BZ16	TOP	TOP ASSEMBLY- WHITE	46B31-081D-03	3441092 THRU CURRENT
BZ16	TOP	TOP ASSEMBLY - BLACK	46B31-081D-04	3441092 THRU CURRENT
BZ16	TOP	TOP ASSEMBLY - GREEN	46B31-081D-05	3441092 THRU CURRENT
BZ16	TOP	TOP ASSEMBLY - MAROON	46B31-081D-06	3441092 THRU CURRENT
BZ16	TOP	TOP ASSEMBLY - PURPLE	46B31-081D-13	3441092 THRU CURRENT
BZ16	TOP	TOP ASSEMBLY - TEAL	46B31-081D-15	3441092 THRU CURRENT
SMM10	TOP	SPECIFY COLORS 504MM	706-187D-01	3441092 THRU CURRENT
SMM10	TOP	SPECIFY COLORS 518MM	706-188D-01	3441092 THRU CURRENT
M17-54	TRACK - SCREW	BOTTOM DOOR TRACK #8 X 1"	601-091A	1306138 THRU CURRENT
MT22	TRACK - SCREW	BOTTOM DOOR TRACK #8 X 1"	601-091A	1306138 THRU CURRENT
MT33	TRACK - SCREW	BOTTOM DOOR TRACK #8 X 1"	601-091A	1306138 THRU CURRENT
MT38	TRACK - SCREW	BOTTOM DOOR TRACK #8 X 1"	601-091A	1306138 THRU CURRENT

ACCESSORIES

MT45	TRACK - SCREW	BOTTOM DOOR TRACK #8 X 1"	601-091A	1306138 THRU CURRENT
MT15	TRACK - SCREW	BOTTOM DOOR TRACK #8 X 1"	601-091A	1306138 THRU CURRENT
MT15-54	TRACK - SCREW	BOTTOM DOOR TRACK #8 X 1"	601-091A	1306138 THRU CURRENT
MT17	TRACK - SCREW	BOTTOM DOOR TRACK #8 X 1"	601-091A	1306138 THRU CURRENT
MT19-54	TRACK - SCREW	BOTTOM DOOR TRACK #8 X 1"	601-091A	1306138 THRU CURRENT
MT19-54	TRACK - SCREW	BOTTOM DOOR TRACK #8 X 1"	601-091A	1306138 THRU CURRENT
MT20	TRACK - SCREW	BOTTOM DOOR TRACK #8 X 1"	601-091A	1306138 THRU CURRENT
MT20-54	TRACK - SCREW	BOTTOM DOOR TRACK #8 X 1"	601-091A	1306138 THRU CURRENT
MT66	TRACK - SCREW	BOTTOM DOOR TRACK #8 X 1"	601-091A	1306138 THRU CURRENT
SLM48	TRACK - SCREW	BOTTOM DOOR TRACK #8 X 1"	601-091A	1306138 THRU CURRENT
BZ13	HOT GAS -LINE	DISCHARGE TUBE	49B30-325D-02	3133015 THRU CURRENT
BZ16	HOT GAS -LINE	DISCHARGE TUBE	49B30-313C	3133015 THRU CURRENT
MT15	WASHER	STAR WASHER - ONE PER ROLLER 1/4 EXT.TOOTH	603-036A	8123598 THRU 1306140
MT15	WASHER	ROLLER ADJUSTMENT	603-404A	1306140 THRU CURRENT
MT17	WASHER	STAR WASHER - ONE PER ROLLER 1/4 EXT.TOOTH	603-036A	8123598 THRU 1306140
MT17	WASHER	ROLLER ADJUSTMENT	603-404A	1306140 THRU CURRENT
MT19-54	WASHER	STAR WASHER - ONE PER ROLLER 1/4 EXT.TOOTH	603-036A	8123598 THRU 1306140
MT19-54	WASHER	ROLLER ADJUSTMENT	603-404A	1306140 THRU CURRENT
MT20	WASHER	STAR WASHER - ONE PER ROLLER 1/4 EXT.TOOTH	603-036A	8123598 THRU 1306140
MT20	WASHER	ROLLER ADJUSTMENT	603-404A	1306140 THRU CURRENT
MT22	WASHER	STAR WASHER - ONE PER ROLLER 1/4 EXT.TOOTH	603-036A	8123598 THRU 1306140
MT22	WASHER	ROLLER ADJUSTMENT	603-404A	1306140 THRU CURRENT
MT33	WASHER	STAR WASHER - ONE PER ROLLER 1/4 EXT.TOOTH	603-036A	8123598 THRU 1306140
MT33	WASHER	ROLLER ADJUSTMENT	603-404A	1306140 THRU CURRENT
MT35	WASHER	STAR WASHER - ONE PER ROLLER 1/4 EXT.TOOTH	603-036A	8123598 THRU 1306140
MT35	WASHER	ROLLER ADJUSTMENT	603-404A	1306140 THRU CURRENT
MT38	WASHER	STAR WASHER - ONE PER ROLLER 1/4 EXT.TOOTH	603-036A	8123598 THRU 1306140
MT38	WASHER	ROLLER ADJUSTMENT	603-404A	1306140 THRU CURRENT
MT45	WASHER	STAR WASHER - ONE PER ROLLER 1/4 EXT.TOOTH	603-036A	8123598 THRU 1306140
MT45	WASHER	ROLLER ADJUSTMENT	603-404A	1306140 THRU CURRENT
MT66	WASHER	STAR WASHER - ONE PER ROLLER 1/4 EXT.TOOTH	603-036A	8123598 THRU 1306140
MT66	WASHER	ROLLER ADJUSTMENT	603-404A	1306140 THRU CURRENT
SLM48	WASHER	STAR WASHER - ONE PER ROLLER 1/4 EXT.TOOTH	603-036A	8123598 THRU 1306140
SLM48	WASHER	ROLLER ADJUSTMENT	603-404A	1306140 THRU CURRENT
MT15	WASHER	TOP DOOR TRACK 1/4 EXT. TOOTH	603-036A	1306138 THRU CURRENT
MT17	WASHER	TOP DOOR TRACK 1/4 EXT. TOOTH	603-036A	1306138 THRU CURRENT
MT19	WASHER	TOP DOOR TRACK 1/4 EXT. TOOTH	603-036A	1306138 THRU CURRENT
MT20	WASHER	TOP DOOR TRACK 1/4 EXT. TOOTH	603-036A	1306138 THRU CURRENT
MT22	WASHER	TOP DOOR TRACK 1/4 EXT. TOOTH	603-036A	1306138 THRU CURRENT
MT33	WASHER	TOP DOOR TRACK 1/4 EXT. TOOTH	603-036A	1306138 THRU CURRENT
MT38	WASHER	TOP DOOR TRACK 1/4 EXT. TOOTH	603-036A	1306138 THRU CURRENT
MT45	WASHER	TOP DOOR TRACK 1/4 EXT. TOOTH	603-036A	1306138 THRU CURRENT
MT66	WASHER	TOP DOOR TRACK 1/4 EXT. TOOTH	603-036A	1306138 THRU CURRENT
SLM48	WASHER	TOP DOOR TRACK 1/4 EXT. TOOTH	603-036A	1306138 THRU CURRENT
MT15	WASHER - SPACER	FOR DOOR CARTRIDGE .028x.032 S/S	603-404A	8123598 THRU CURRENT
MT17	WASHER - SPACER	FOR DOOR CARTRIDGE .028x.032 S/S	603-404A	8123598 THRU CURRENT
MT19-54	WASHER - SPACER	FOR DOOR CARTRIDGE .028x.032 S/S	603-404A	8123598 THRU CURRENT
MT20	WASHER - SPACER	FOR DOOR CARTRIDGE .028x.032 S/S	603-404A	8123598 THRU CURRENT
MT22	WASHER - SPACER	FOR DOOR CARTRIDGE .028x.032 S/S	603-404A	8123598 THRU CURRENT
MT33	WASHER - SPACER	FOR DOOR CARTRIDGE .028x.032 S/S	603-404A	8123598 THRU CURRENT
MT38	WASHER - SPACER	FOR DOOR CARTRIDGE .028x.032 S/S	603-404A	8123598 THRU CURRENT
MT45	WASHER - SPACER	FOR DOOR CARTRIDGE .028x.032 S/S	603-404A	8123598 THRU CURRENT
MT66	WASHER - SPACER	FOR DOOR CARTRIDGE .028x.032 S/S	603-404A	8123598 THRU CURRENT
SLM48	WASHER - SPACER	FOR DOOR CARTRIDGE .028x.032 S/S	603-404A	8123598 THRU CURRENT
BZ16	WICKING	CONDENSATE PAN	703-982B-05	3133015 THRU CURRENT
MT12	WICKING	CONDENSATE PAN	703-444A	3133015 THRU CURRENT
MT17	WICKING	CONDENSATE PAN	703-444A	3133015 THRU CURRENT
MT18	WICKING	CONDENSATE PAN	703-782A	3133015 THRU CURRENT
MT21	WICKING	CONDENSATE PAN	703-782A	3133015 THRU CURRENT
MT22	WICKING	CONDENSATE PAN	703-444A	3133015 THRU CURRENT
MT27	WICKING	CONDENSATE PAN	703-444A	3133015 THRU CURRENT

ACCESSORIES

MT27	WICKING	CONDENSATE PAN	703-782A	3133015 THRU CURRENT
MT66	WICKING	CONDENSATE PAN	703-444A	3133015 THRU CURRENT
MT72	WICKING	CONDENSATE PAN	703-444A	3133015 THRU CURRENT
MT 20	WICKING	CONDENSATE PAN	703-969A	3133015 THRU CURRENT
MT15-54	WICKING	CONDENSATE PAN	703-789A	3133015 THRU CURRENT
MT17-54	WICKING	CONDENSATE PAN	703-789A	3133015 THRU CURRENT
MT33	WICKING	CONDENSATE PAN	703-444A	3133015 THRU CURRENT
MT35	WICKING	CONDENSATE PAN	703-782A	3133015 THRU CURRENT
MT38	WICKING	CONDENSATE PAN	703-444A	3133015 THRU CURRENT
MT45	WICKING	CONDENSATE PAN	703-444A	3133015 THRU CURRENT
MT49	WICKING	CONDENSATE PAN	703-444A	3133015 THRU CURRENT