

## Easy Chopper 3

Model: 57500-( )

### OPERATING AND MAINTENANCE INSTRUCTIONS

#### **Important**

1. To get the best operation and life from your Easy Chopper 3, please read and comply with these instructions.
2. Clean machine thoroughly before first use and after each use using cleaning instructions below.
3. Minimize the use of alkaline cleaners as they may cause pitting and dulling of the finish.

#### **Safety Instructions**

**Remember that the blades are VERY SHARP; be careful when handling and operating the equipment to keep hands away from the cutting edges.**

#### **Operation of Easy Chopper 3**

1. Always check the equipment before each use to ensure that it is clean & free of debris. Also inspect the blades to ensure there are no broken, nicked, or dulled blades and if found, replace the blade assembly before using the equipment again.
2. Place the chopper on a firm, clean, and flat work surface.
3. Be sure that the cleaning gasket is in place before using. Also, ensure that the color of the push block matches the colored indicator on the blade assembly to confirm they are a matching set.
4. Prepare the produce to be cut (Chopped, Sliced, or Wedged).
5. Lift HANDLE and place the produce on the blades with the flat side down.
6. Remove hand/fingers from the cutting area, use free hand to grasp the leg of the frame, and with a strong, quick thrust, bring the PUSH BLOCK down to force the produce through the BLADES. Lift and repeat.
7. Clean the machine after prep work is completed using cleaning instructions below.

**Caution:** Do not attempt to chop produce larger than the opening in the BLADE HOLDER (4-1/4" x 4-1/4").

**Note:** Additional blade and PUSH BLOCK sets can be purchased separately. Be sure to always use a PUSH BLOCK and blade set that are compatible or damage to the equipment will result. To check for compatibility, compare the color of the push block to the colored indicator on the blade assembly. The color of the cleaning gasket should match the push block and blade assembly as well.

#### **To Clean**

1. Remove the PUSHER assembly off the GUIDE RODS. Using the tabs on the cleaning gasket, pull the cleaning gasket from the push block to remove debris from the slots.
2. Remove the blade assembly from the locating pins.
3. Thoroughly wash the PUSHER & BLADE assemblies, and cleaning gasket using warm water and a mild detergent.  
**CAUTION:** Do not wipe across the sharp side of the blades, or use abrasive pads on the blades. Wiping across the sharp side of the blades in any form may cause injury and will dull the blades.
4. To aid cleaning, spray pressurized water across the blade assembly from the dull side to force out debris. Pressurized water can also be sprayed on the push block to force out remaining debris.
5. Allow all pieces to air dry.
6. Once all pieces are dry, reassemble the components to the Chopper. It is suggested that mineral oil is applied to the guide rods every time the equipment is cleaned.

#### **Chopping Tips**

Cut produce before chopping and place a cut surface against the BLADES. Onions and tomatoes dice best if cut from top to bottom. They may be cut in half, or if smaller dices are desired, they can be cut several times in this direction.

#### **To Lubricate**

When needed, lubricate the GUIDE RODS with Mineral Oil, Food Grade Lubricant, or rub them with Paraffin.  
DO NOT LUBRICATE WITH COOKING OIL – IT GETS STICKY!

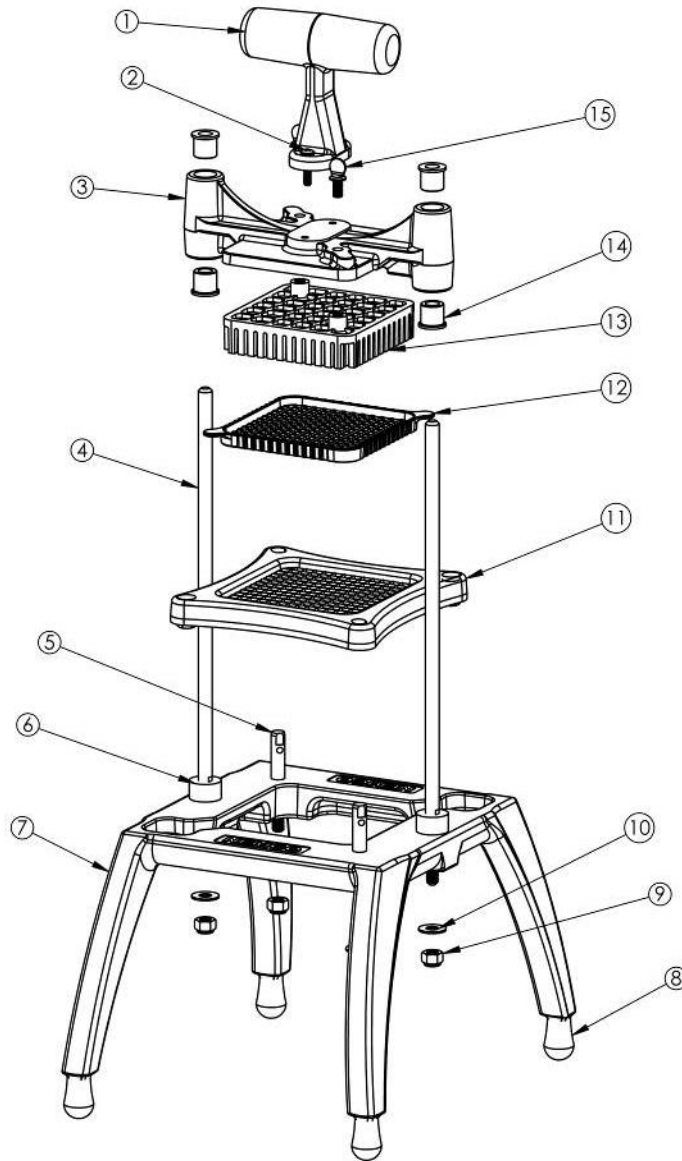

	57500-1	57500-2	57500-3	57500-4	57500-5	57500-6	57500-7	Description
1	55446	55446	55446	55446	55446	55446	55446	HANDLE
2	45652	45652	45652	45652	45652	45652	45652	SCREW, #10-32
3	57403	57403	57403	57403	57403	57403	57403	PUSH BLOCK GUIDE
4	57431	57431	57431	57431	57431	57431	57431	GUIDE ROD
5	56383	56383	56383	56383	56383	56383	56383	LOCATING PIN
6	55432	55432	55432	55432	55432	55432	55432	BUMPER
7	57429	57429	57429	57429	57429	57429	57429	FRAME
8	45457	45457	45457	45457	45457	45457	45457	RUBBER FOOT
9	46091	46091	46091	46091	46091	46091	46091	NYLOCK NUT, 5/16-18
10	45154	45154	45154	45154	45154	45154	45154	WASHER, 5/16"
11	57424-1 (Red)	57424-2 (Blue)	57424-3 (Green)	57424-4 (Black)	57424-5 (Red)	57424-6 (Blue)	57424-7 (Green)	BLADE ASSEMBLY
12	56381-1 (Red)	56382-2 (Blue)	56381-3 (Green)	56382-4 (Black)	56381-1 (Red)	56382-2 (Blue)	56381-3 (Green)	CLEANING GASKET
13	57417-1 (Red)	57418-2 (Blue)	57417-3 (Green)	57418-4 (Black)	57417-1 (Red)	57418-2 (Blue)	57417-3 (Green)	PUSH BLOCK
14	55435	55435	55435	55435	55435	55435	55435	BUSHING
15	45632-3	45632-3	45632-3	45632-3	45632-3	45632-3	45632-3	THUMB SCREW, 1/4-20

**NEMCO FOOD EQUIPMENT** - 301 Meuse Argonne, Hicksville, Oh 43526  
 Phone: (419) 542-7751 – Fax: (419) 542-6690 – Toll Free: 800-782-6761  
[www.NemcoFoodEquip.com](http://www.NemcoFoodEquip.com)