



NU-VU® Models:

QBT-4/8

&

QBT-5/10

Oven / Proofer

A Quality Product Made in the U.S.A.

By:

NU-VU® Food Service Systems

5600 13th STREET

MENOMINEE, MICHIGAN 49858-1029

(906) 863-4401 FAX (sales) (906) 863-5889

(800) 338-9886 FAX (service) (906) 863-6332

Revised:

April 2, 2019

(QBT)

(This page is intentionally left blank)

Dear Customer:

Thank you for buying NU-VU® equipment. We think you have purchased one of the best units on the market today.

Every piece of NU-VU® equipment is put through a full electrical test. In addition, NU-VU® ovens are randomly selected for test baking to ensure you are receiving the best product possible. The interior of the oven may darken slightly during this testing process. This coloration is normal and occurs in any oven that has been operated for a few hours. It will not affect the operation, durability or warranty of your NU-VU® equipment.

This OWNER'S MANUAL has been put together to give you a good general knowledge of your equipment. It is not a detailed technical manual; such a book is unnecessary for the daily care and operation of your unit. However, this manual *does* contain some basic trouble-shooting and service information. If this OWNER'S MANUAL does not answer your questions or solve your problems please call us at (906) 863-4401. You can also fax your question or comment to our Service Department at (906) 863-6322 or Toll Free at (800) 338-9886. You can even e-mail us at service@nu-vu.com. One of our service technicians will be glad to assist you. Please remember to supply the model number and serial number of your NU-VU® equipment when you contact us. When calling for service or parts, try to be at the equipment location so that we can better assist you with your service or parts needs.

Each page carries information to help you use this OWNER'S MANUAL. The header at the top of each page contains the title of the section you are currently in. The footer at the bottom of each page carries the page number, our telephone number, and our Sales and Service fax numbers.

All sections begin at the top of a page and start like this:

SECTION HEADING

All sub-section headings are on the left side of each page and look like this:

SUB-SECTION HEADING:

SUB-SECTION HEADING - -

**IMPORTANT: THESE SHADED BOXES WILL CONTAIN IMPORTANT WARNING,
OPERATING AND/OR SAFETY INFORMATION!**

The illustrations used throughout this OWNER'S MANUAL are titled in their lower left-hand corners. A complete list of these illustrations, along with their respective page numbers, can be found on page *IV* of this manual.

(This page is intentionally left blank)

TABLE OF CONTENTS

| | |
|---------------------------------------------|----|
| ABOUT YOUR QBT | 1 |
| QBT Specifications | 2 |
| RECEIPT, INSTALLATION AND START-UP | |
| Receipt | 3 |
| Installation | 4 |
| Connection of Electrical Supply | 4 |
| Connection of Water Supply | 6 |
| START-UP | |
| Oven / Proofer | 7 |
| | |
| OPERATING INSTRUCTIONS | |
| Proofer | |
| For the Standard AUTOFILL Proofer | 8 |
| Oven | 9 |
| | |
| PROGRAMMABLE CONTROLLER..... | 10 |
| | |
| MAINTENANCE AND CLEANING GUIDE | |
| Maintenance | 14 |
| AUTOFILL Proofer Dry-Out Procedure | 14 |
| Oven Dry-Out Procedure | 14 |
| Cleaning | 15 |
| | |
| SERVICE AND REPLACEMENT GUIDE | 16 |
| Door Test Procedure | 17 |
| Door Gasket, How to Replace..... | 18 |
| Replacing the Oven Door Gasket..... | 18 |
| Replacing the Proofer Door Gasket..... | 18 |
| | |
| NU-VU® EQUIPMENT WARRANTY | |
| Parts | 19 |
| Labor | 19 |
| Warranty Limitations | 20 |
| Parts Return Procedure and Conditions | 21 |
| | |
| MISC. | |
| Notes..... | 22 |

***** NOTICE *****

Record the model number and serial number from the nameplate on the side of your unit on page 21 in the WARRANTY section for future reference. Please be ready to give these numbers to our Service Department when ordering replacement parts or requesting service. When calling for service or parts, try to be at the equipment location so that we can better assist you with your service or parts needs.

LIST OF ILLUSTRATIONS

| | | |
|---------------|--------------------------------|---|
| Fig. #1 | Installation | 3 |
| Fig. #2 | Power Supply Connections | 5 |
| Fig. #3 | Stand-by Screen | 7 |
| Fig. #4 | Oven / Proofer Controls | 8 |

(This page is intentionally left blank)

ABOUT YOUR QBT

The NU-VU® QBT is an electrically powered and operated commercial baking/cooking appliance. It does not require exterior venting under normal circumstances; however, hood and venting requirements vary from country to country, state to state, and even from locality to locality. For this reason, NU-VU® cannot give specific detailed information regarding your individual application. Your local building inspector, licensed contractor, or installer is best qualified to determine your specific needs.

The oven section of the QBT features our patented V-AIR® air movement system. A top-mounted blower moves the air down through the side walls to be heated, then out through specially designed hole patterns to provide even heat distribution throughout the oven. Your product is baked evenly from top to bottom, side to side, front to back without turning pans. You can load the oven completely with pans having the same product, bake, and remove the entire load at the same time. The bake is uniform because each shelf now receives essentially the same air pattern.

It is constructed of stainless steel both inside and out. The front and back frames are cut from single sheets of stainless steel. Components such as temperature and humidity controls, timers, switches, motors, heating elements, and others are thoroughly tested before shipment. Ongoing research and development projects are used to introduce the latest and most dependable components.

The NU-VU® QBT is designed for:

- Automatic pan positioning
- Rapid and even baking
- Easy cleaning
- Simple operation
- Dependability
- Low energy consumption
- Low maintenance
- Rapid servicing

The AUTOFILL option eliminates the manually filled water pan in the proofer, but requires connection to a pressurized potable water supply. The immersible element in the AUTOFILL water pan distributes humidity evenly throughout the proofer compartment to provide the controlled humidity necessary for proper proofing action.

IMPORTANT: This appliance is not intended for use by persons (including children) with reduced physical, sensory or mental capabilities, or lack of experience and knowledge, unless they have been given supervision or instruction concerning use of the appliance by a person responsible for their safety.

Children should be supervised to ensure that they do not play with the appliance.

QBT SPECIFICATIONS:

Exterior Dimensions

QBT-4/8 Height = 77-7/16" (1967mm) Width = 32-1/4" (820mm) Depth = 37" (819mm)

QBT-5/10 Height = 83-7/8" (2131mm) Width = 32-1/4" (820mm) Depth = 36-15/16" (939mm)

Interior Dimensions (usable space)

Oven:

QBT-4/8 Height = 22" (558mm) Width = 18-1/4" (464mm) Depth = 28-1/2" (724mm)

QBT-5/10 Height = 22-1/4" (566mm) Width = 18-1/4" (464mm) Depth = 28-1/2" (724mm)

Proofer:

QBT-4/8 Height = 27-1/8" (688mm) Width = 18-3/8" (467mm) Depth = 27-1/2" (698mm)

QBT-5/10 Height = 33-5/8" (855mm) Width = 18-3/8" (467mm) Depth = 28-5/8" (728mm)

Door Swing (straight out from face of unit)

QBT-4/8 & QBT-5/10 Oven = 33-1/2" (851mm) Proofer = 33-1/2" (851mm)

Capacities

QBT-4/8

Oven = Four (4) 18" x 26" (457mm x 660mm) full size sheet pans with 5" (127mm) spacing.

Proofer = Eight (8) 18" x 26" (330mm x 457mm) full size sheet pans with 3-1/2" (88mm) spacing

QBT-5/10

Oven = Five (5) 18" x 26" (457mm x 660mm) full size sheet pans with 4" (102mm) spacing.

Proofer = Ten (10) 18" x 26" (330mm x 457mm) full size sheet pans with 3-1/4" (83mm) spacing.

Listings/Approvals



Service Connections

Electrical:

208 volt, 60 Hz

240 volt, 60 Hz

230V, 50 Hz

Single or three phase, to be hard wired on site. No separate neutral is required

380 volt, 50 Hz

415 volt, 50 Hz

Three phase, to be hard wired on site. A separate neutral is required

The oven compartment uses two 3,500-watt heating elements.

The proofer compartment for the standard AUTOFILL proofer uses two 600-watt heating elements and one 500-watt humidity element.

Water:

Standard AUTOFILL units require direct connection to a pressurized potable water supply by means of 1/4" (6.35mm) OD plastic or copper tubing.

Minimum water pressure: 20 PSI (131 kPa) Maximum water pressure 100 PSI (689 kPa).

Any unit requiring connection to a water supply comes equipped with a 1/4" (6.35mm) push to connect fitting installed on the back of the unit.

RECEIPT, INSTALLATION AND START-UP

RECEIPT:

It is essential to inspect the unit immediately when it arrives. NU-VU® has placed instructions on the packaging to help avoid damage in transit. However, negligent handling can produce hidden damage.

These steps should be followed:

- A. Uncrate the unit carefully and check the entire unit (top, front, back, and both sides) for any visible or hidden damage.
- B. Remove the unit from the shipping pallet and inspect the bottom (including the casters) for any damage. Check the casters and the drip pan holder under the unit.
- C. If any damage is noted after the driver leaves immediately contact the freight company and notify NU-VU® at (800) 338-9886 immediately after filing a freight claim.
- D. Check the oven and proofer doors. Make sure both doors close completely, and that the door gaskets seal firmly (refer to the *DOOR TEST PROCEDURE* in the *SERVICE AND REPLACEMENT GUIDE*). If they do not close or seal properly please contact the NU-VU® Service Department for instructions and assistance in any required adjustments.

INSTALLATION:

Record the model number and complete serial number of your unit in the spaces provided on page 21 of this manual. You will need these numbers if you should ever need to contact our Service Department concerning adjustments, replacement parts or other service needs. When calling for service or parts, try to be at the equipment location so that we can better assist you with your service or parts needs.

Roll the unit into the exact position where it is to be operated. Make sure there will be enough clearance on each side of the unit for proper cooling during operation, and for ease of access during maintenance or service.

NU-VU® recommends a minimum clearance of 4" (102mm) at the back and both sides of the unit. Do not install this unit in a location where splashing or spaying of water onto exterior of unit is likely to occur.

Mark the locations of the electrical and water connections on the wall.

If required by code, standard or law; the appliance must be secured to the building structure when the appliance is in service. If the appliance is supplied with an eyebolt installed in the rear of the appliance for the purpose of securing it to the building structure with a wire rope lanyard or welded steel chain.

Check the swing of both the oven and proofer doors, making sure they have enough room to open completely without hitting anything or obstructing the work area.

Move the unit out from its operating position and proceed with the service connections.

Connection of Electrical Supply - -

Check to determine that the power source is the same voltage and phase as that indicated on the label on the side of the unit. If the voltage or phase *is not* the same, please call NU-VU® service department at (800) 338-9886.

IMPORTANT: DO NOT CONNECT THIS UNIT IF YOUR POWER SOURCE DOES NOT MATCH THE REQUIREMENTS AS LISTED ON THE UNIT LABEL!

This equipment must be installed and connected in accordance with all applicable federal, state, province, and/or local electrical codes having jurisdiction using properly rated all pole mains protection and all pole mains disconnect. All electrical connections must be made with COPPER WIRE ONLY in the correct gauge for the application. The unit may be connected either through a cord, plug and receptacle-type connection or direct wiring using flexible conduit. Allow enough slack in the wiring to allow for equipment to be moved during installation or any required maintenance and servicing.

WARNING: ALL POWER MUST BE TURNED OFF AT THE ELECTRICAL SUPPLY WHILE THIS UNIT IS BEING CONNECTED!

The electrician should remove the center rear panel to expose the power supply connections at the power terminal block on top of the oven compartment. A wiring schematic is attached to the wiring near the power terminal connections.

Proper electrical connections will vary depending on the voltage and phase requirements of the unit and available power supply. The following instructions are for the most common configurations (refer to *Fig. #2* on page 5), and may be modified to fit your installation.

- A. The electrician must install a cable clamping device or cord restraint in the rear access hole. This cable clamping device must be firmly attached to the unit, and appropriately sized for the power supply wire or cord being used.
- B. Take note of the labeling on the Oven terminal connections (Line 1, Line 2 and Line 3) at the Power Terminal Block.
- C. Carefully identify the power source connections and attach them to the appropriate terminals. Make sure all connections are clean and tight.
- D. Be sure the unit is properly grounded BEFORE use by attaching a grounding wire to the ground lug next to the power terminal block.

IMPORTANT: IN A THREE PHASE SYSTEM ANY WILD LEG (MORE THAN 120 VOLTS TO GROUND) MUST ALWAYS BE CONNECTED TO L-2!

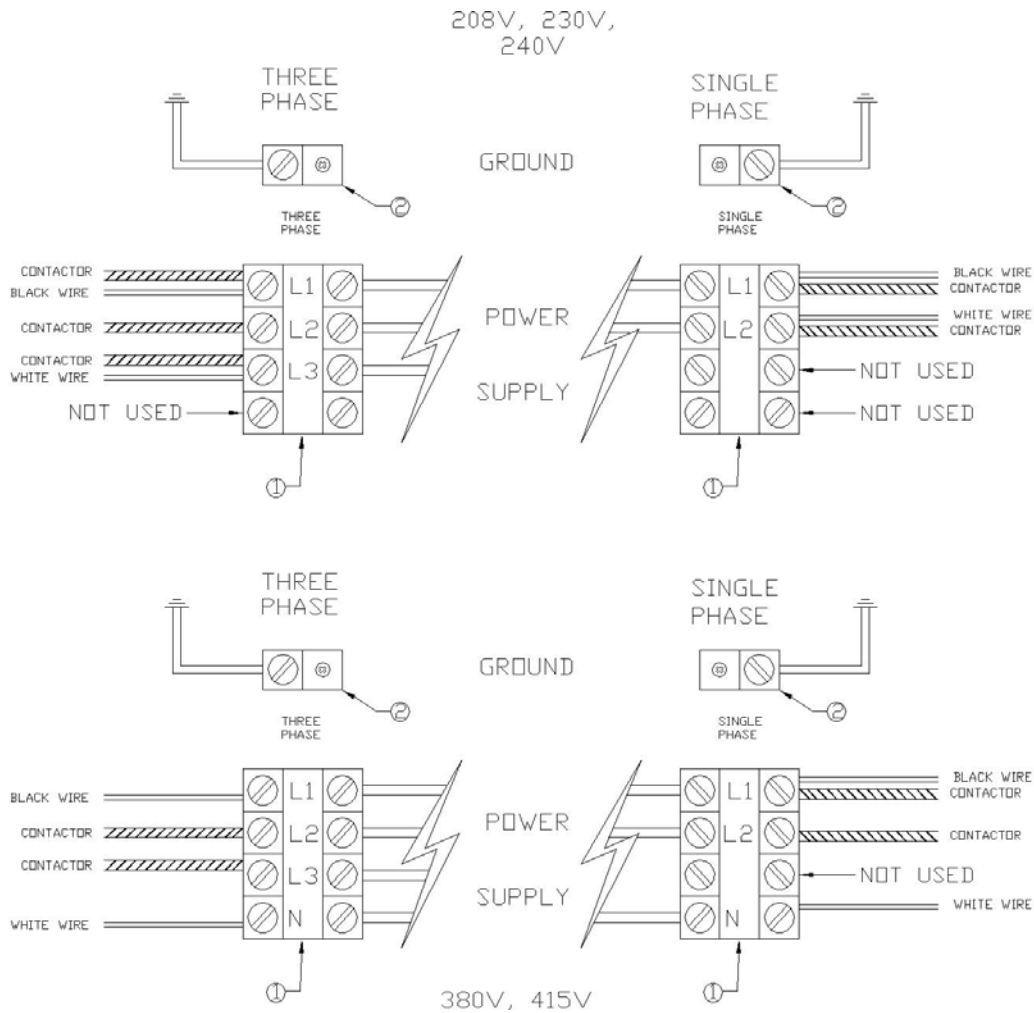

Fig. #2 – Power Supply Connections

- E. Engage the main power supply.
- F. Check the voltage at the terminals on the power terminal block with a voltmeter and compare the readings with the label listings on the side of the unit. If the readings match, the unit is ready for its initial START-UP. If the readings **DO NOT** coincide you must call the NU-VU® Service Department.
- G. Replace the center rear panel. Be careful not to pull or pinch any wires while installing the panel.

Connection of water supply - -

IMPORTANT: THIS UNIT NEEDS TO BE INSTALLED WITH ADEQUATE BACKFLOW PROTECTION TO COMPLY WITH APPLICABLE FEDERAL, STATE AND LOCAL CODES.

IMPORTANT: THIS UNIT REQUIRES A SCREEN OF AT LEAST 100 MESH TO BE INSTALLED IMMEDIATELY UPSTREAM OF ALL CHECK VALVE TYPE BACKFLOW PREVENTERS USED FOR WATER SUPPLY PROTECTION. THE SCREEN SHALL BE ACCESSIBLE AND REMOVABLE FOR CLEANING OR REPLACEMENT.

NU-VU® strongly recommends that **SOFT WATER ONLY** be used in any unit requiring a water supply. Also, a good quality water filter must be installed in-line between the unit connection and the water supply to guard against clogging and mineral build-up in the components. This is extremely important in areas having hard water. The water filter head is installed on the rear of the equipment, the filter cartridge is shipped inside the proofer.

- A. Run 1/4" (6.35mm) OD tubing from the water supply line to the unit location. Allow some slack in the tubing for final unit positioning and any future service requirements. Avoid any kinks or strains on the tubing, and position the tubing where it will not be damaged in any way.
- B. The tubing end that attaches to the back of the unit must not be damaged or deformed in any way. The cut end should be cut straight and clean with no deforming of the tubing. All burrs and sharp or rough edges should be removed to ensure a proper and leak-free connection.
- C. Position the tubing so that it runs straight into the intake water fitting on the rear of the unit. Be careful not to kink the tubing if you bend it, and do not bend the tubing within two (2) inches of the cut end.
- D. Push the end of the tubing all the way into the intake water fitting approximately 1/2" (12.7mm)
- E. Push the unit back into place and set the brakes on the front casters.
- F. The proofer compartment of the NU-VU® QBT is equipped with a bottom drain centered directly under the proofer door. Please install the included drain pan in the bracket under the proofer.

Careful attention to these simple procedures will help to ensure an installation without leaks. If you have any questions or problems, please call the NU-VU® Service Department at (800) 338-9886.

NOTE: Your QBT is equipped with a drain in the floor of the proofer compartment. This drain prevents the accumulation of excess water. Please slide the included drain pan into the bracket under the proofer door to catch any draining water.

**YOUR NU-VU® QBT SHOULD NOW BE
READY FOR ITS INITIAL START-UP!**

IMPORTANT: IMPROPER INSTALLATION, MISUSE, OR OTHER FAILURE TO FOLLOW THESE INSTRUCTIONS MAY CAUSE SEVERE EQUIPMENT DAMAGE OR PERSONAL INJURY, AND MAY ALSO VOID ALL OR PART OF YOUR NU-VU® WARRANTY!

* * * Notice * * *

National Sanitation Foundation (NSF) guidelines require that all interior parts be removable without the use of tools. This equipment has been factory assembled to safely accommodate rough handling through shipment, delivery and original installation. After any maintenance, cleaning or required service work the interior sheet metal parts should be reassembled and fastened hand-tight only, but still be tight enough to prevent any rattle or movement of parts.

START-UP:

Fig. #3 – Stand-by Screen

Oven / Proofer - -

- A. Engage the main electrical and water supplies. Ensure that the oven and proofer doors are closed.
- B. Press the rocker switch to the **ON** position. The NU-VU logo will be displayed for a short period of time, after which the Stand-by Screen will be displayed. Press the oven ON/OFF key then press the bread icon on the left half of the display to start the oven. The controller is preprogrammed with recommended baking time and temperature settings. You may need to modify these settings for your location. The interior of the oven should illuminate and the oven blower wheel should begin to rotate.
- C. Open the oven door. The motor/blower wheel should come to a stop as the door opens and the micro switch in the front face is released.
- D. Close the oven door securely. The oven blower wheel should restart. The oven will begin to heat to the oven temperature set point.
- E. Press the Proofer ON/OFF key then press the bread icon on the right half of the display to start the proofer. The interior of the proofer should illuminate and the proofer blower wheel should begin to rotate. The proofer will begin to heat to the proofer temperature set point. A fog will begin to appear on the proofer door after several minutes.
- F. Allow the oven and proofer to pre-heat for at least 30 minutes. An audible alarm will sound when the oven and/or proofer reach the set point.

If you have any questions or problems, please call the NU-VU® Service Department at (800) 338-9886.

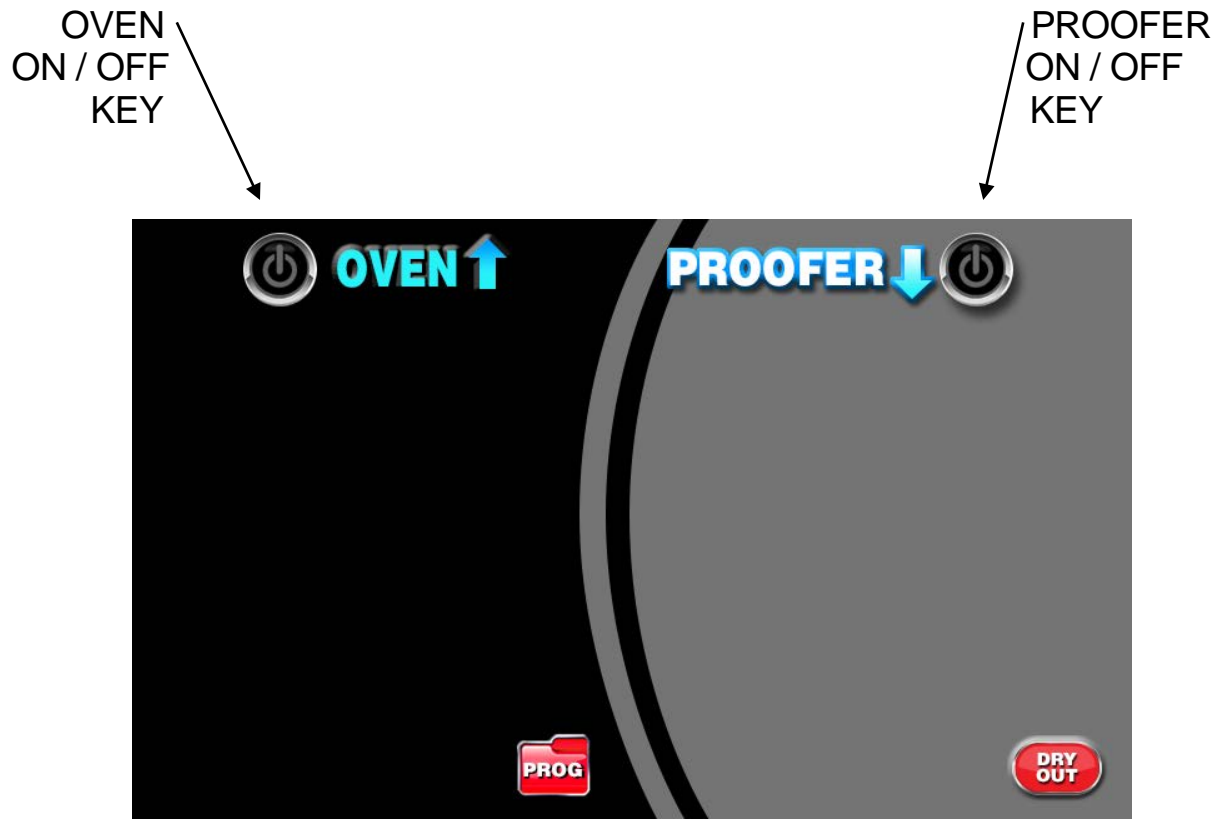
Your AUTOFILL QBT is now ready to operate!

OPERATING INSTRUCTIONS

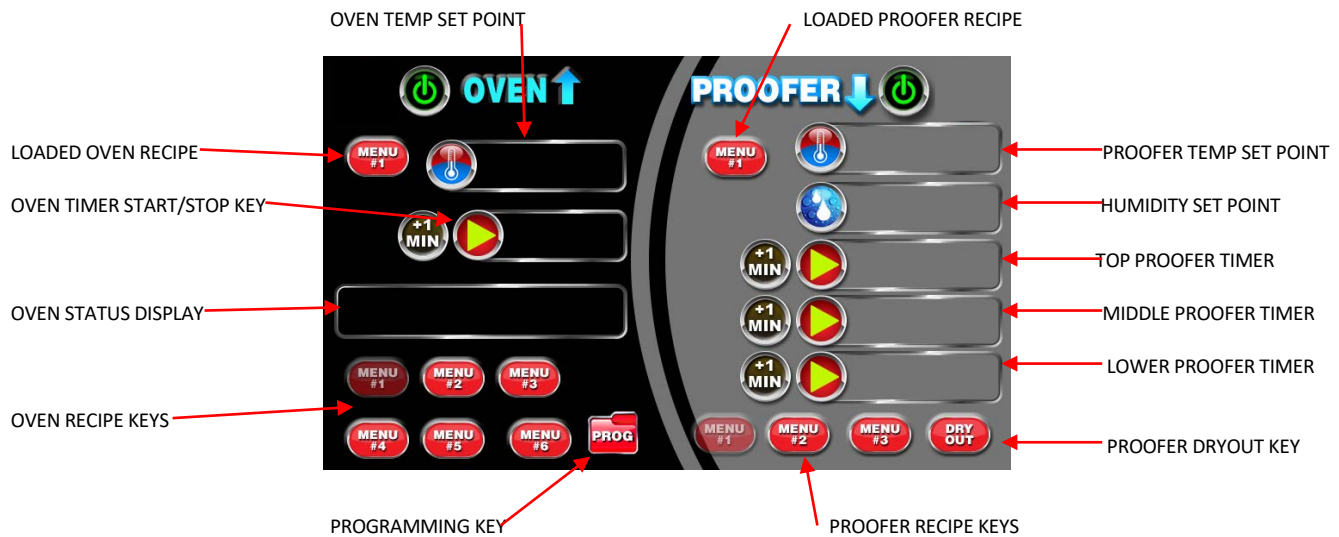

Fig. #4 –Oven & Proofer Controls

PROOFER:

Begin to pre-heat the proofer section of the QBT about 20 to 30 minutes before its scheduled use.

- A. Set out the desired proofer product for thawing. Be sure to allow sufficient time in your schedule for both the product and your equipment to reach the correct conditions.
- B. Prepare the proofer:
 1. Ensure the rocker switch is in the **ON** position. The NU-VU logo will be displayed for a short period of time, after which the stand-by screen will be displayed.
 2. Press the proofer ON/OFF key then press the bread icon on the right half of the display to start the Proofer. The controller is preprogrammed with recommended proofing time, temperature, and humidity settings. You may need to modify these settings for your location.
 3. Make sure water is being supplied to the proofer. An AUTOFILL unit heats water directly inside the proofer, raising the internal humidity level almost immediately.
 4. The proofer pre-heat screen will be displayed until the set point is reached after which an audible alarm will sound. A light to moderate fogging will appear on the proofer door. The display will now resemble that of figure #4 (above).
- C. Load the product. The pans should be pushed all the way back and centered from side to side as much as possible on each proofer shelf to allow for proper air circulation over and around your product. If you are loading a single pan, center it on the Shelf from side to side and front to back.
- D. Press the proofer START/STOP key to begin the countdown timer corresponding to the location of the proofer that was loaded (Top, Middle or Lower) as a reminder to check your proof.
- F. Monitor the proofing process. Your proofer is functioning properly if there is a light to moderate fogging on the proofer door. No fogging means your proofer may be running too hot, too dry, or both. excessive fogging (with water running down the glass) means your proofer may be running too cold, too wet, or both. Check the product and adjust the proofer temperature and humidity controls as necessary.
- G. Load the oven when your product is fully proofed. Yeast products should be 65% to 75% of the desired finished size at the end of the proof cycle. Generally speaking, properly proofed bread should have a soft, silky smooth feel to it when touched. It should never be anything more than slightly tacky. If the dough sticks to your finger and does not pull off cleanly, the dough is too wet.

OVEN:

Since your oven requires time to reach the proper temperature, you must plan ahead so your oven and product are ready at the same time.

WARNING: WE TRY TO “BURN OFF” ANY MANUFACTURING OILS INSIDE OF YOUR OVEN BEFORE SHIPMENT. HOWEVER, SOME OILS MAY REMAIN, CAUSING YOUR OVEN TO SMOKE DURING INITIAL OPERATION. SIMPLY ALLOW THE OVEN TO RUN AT 350°F FOR AN HOUR OR TWO TO COMPLETE THE BURN-OFF AND THE SMOKING SHOULD STOP. WE APOLOGIZE FOR ANY INCONVENIENCE THIS MAY CAUSE.

To operate the oven section:

- A. Prepare the oven:
 1. Ensure the rocker switch is in the **ON** position. The NU-VU logo will be displayed for a short period of time, after which the stand-by screen will be displayed.
 2. Press the oven ON/OFF key then press the bread icon on the left half of the display to start the oven. The controller is preprogrammed with recommended Baking time and temperature. You may need to modify these settings for your location.
 3. The oven pre-heat screen will be displayed until the set point is reached after which an audible alarm will sound. The display will now resemble that of figure #4 (page 8).
- B. Load the oven from the top down, placing a single full size pan on each shelf. Push the pans all the way to the rear. Single pans should be centered from side to side and front to back. If the top shelf is too high to be reached safely and easily, empty pans should be placed on the shelf to guide the air flow over and around your product for the best possible results.
- C. Close the oven door securely. It is important to keep the oven door closed unless loading or removing product to maintain oven temperature, reduce baking time, and minimize energy usage.
- D. Press the oven START/STOP key to start the count-down timer. The alarm will sound when the timer has reached zero.
- E. As soon as the product is finished baking, open the oven door and remove the product quickly. You can load more product into the oven immediately, or close the oven door and allow the oven to recover to the set baking temperature. Allowing the oven a few minutes of recovery time between bakes results in a quicker and better bake.
- F. When all baking is done for the day, turn the oven side of the control off and complete the daily *DRY-OUT PROCEDURE* outlined in the *MAINTENANCE AND CLEANING GUIDE*.

CAUTION: STAND AWAY FROM THE FRONT OF THE OVEN WHEN OPENING THE OVEN DOOR AFTER A BAKING CYCLE TO AVOID EXPOSURE TO HEAT AND STEAM!

PROGRAMMABLE CONTROLLER

OVEN
ON / OFF
KEY

PROOFER
ON / OFF
KEY



To turn on the oven and/or proofer, press the corresponding ON/OFF key.

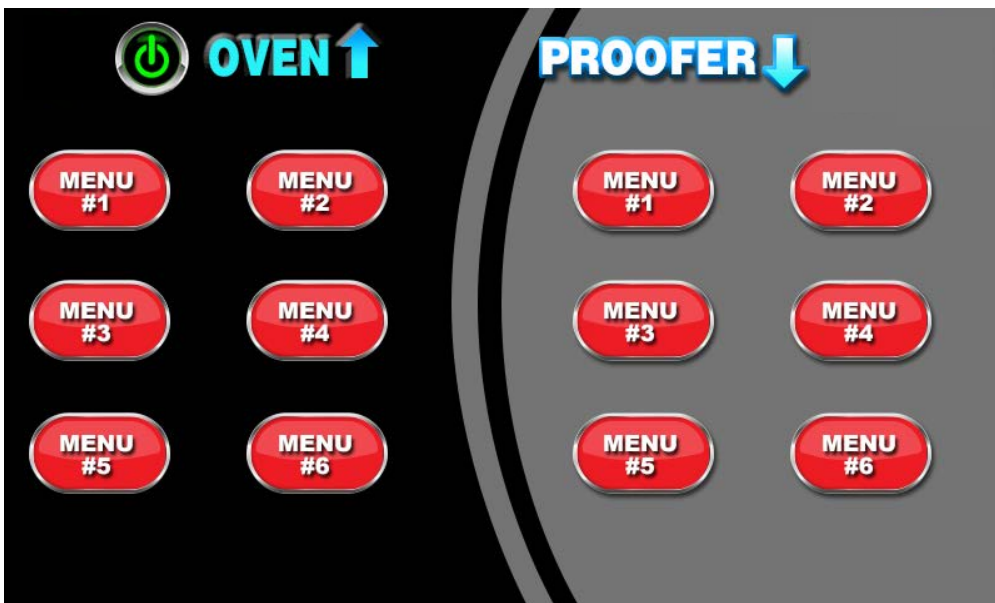

Loading your saved menu settings is done by simply pressing a menu key.

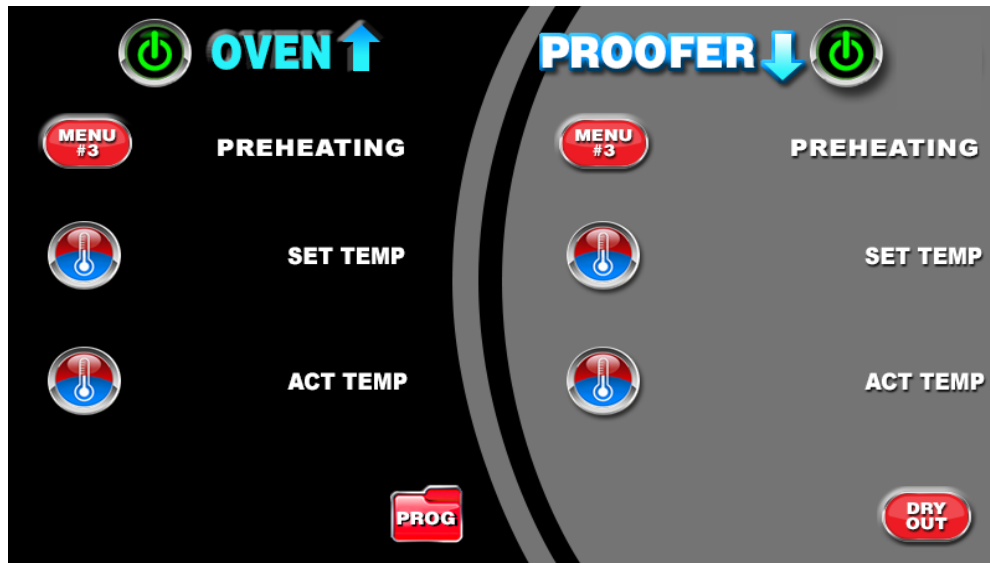

The oven and / or proofer will begin to preheat automatically when a menu is loaded. The actual cavity temperatures will be displayed during the preheat cycle.

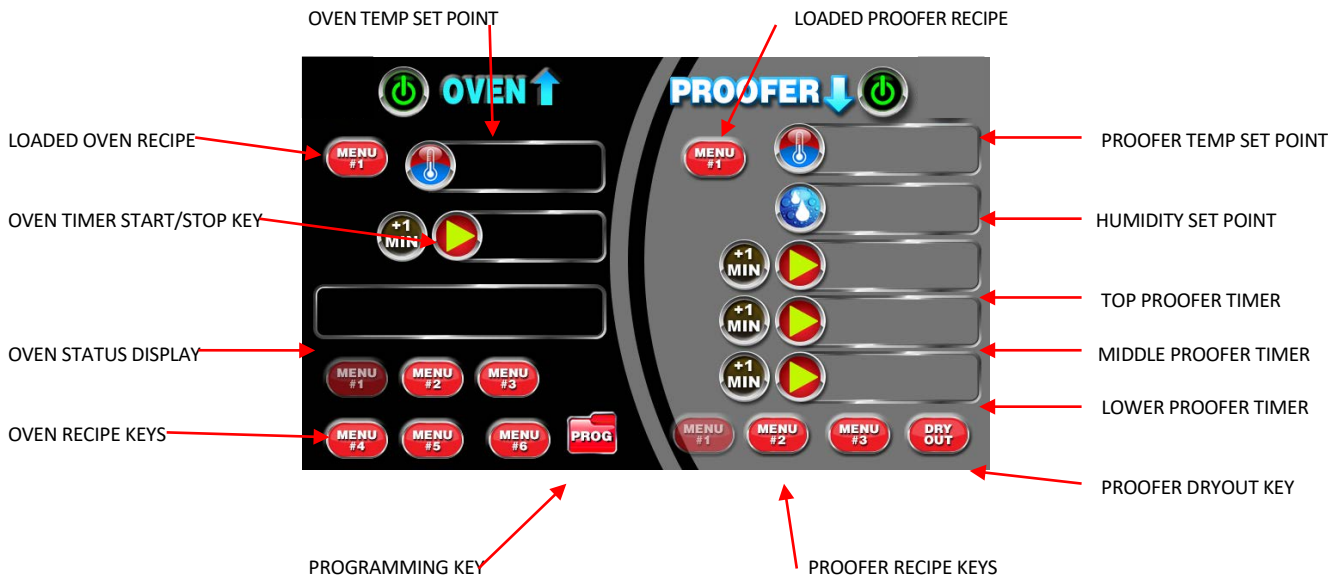

Once the preheat cycle is complete, the oven and / or proofer is ready for use and product can be loaded. After your product is loaded and the door is closed, press the corresponding timer START/STOP key to begin the countdown timer. After the timer has counted down to zero, an audible alarm will sound to signal the end of the baking or proofing cycle. Press the corresponding timer START/STOP key to reset the timer and then remove the finished product.

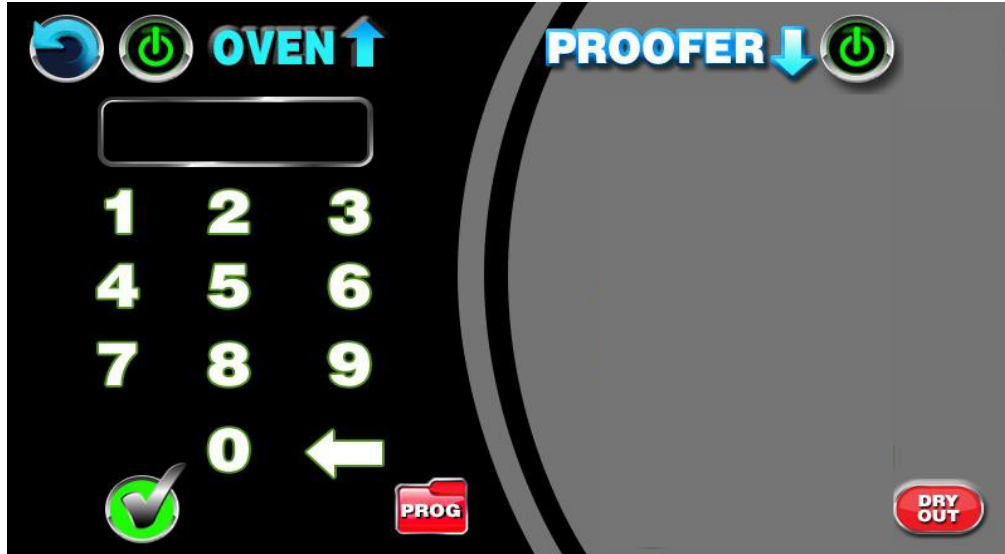

The control comes preprogrammed with default settings for all the menus. The settings can be changed to suit your needs. Pressing the programming key will bring up a numeric keypad, key in **7123** followed by the enter key (the check mark key).



Press the menu key for the menu that you would like to edit. For this example, the proofer bread menu is used.



Editing a menu setting is done by pressing the value you would like to change, keying in the new value and pressing the enter key (the check mark key) to accept the new value; pressing the back key (the curved arrow in the upper corner) will disregard the change. After you are finished making changes to the menu settings, press the enter key to save the menu. When you are finished making all changes, press the back key (the curved arrow in the upper corner) to exit the menu edit screen. The new settings will be used the next time the menu is loaded. If you make changes to a recipe that is currently loaded, the new values will not be used until the menu is reloaded.

MAINTENANCE AND CLEANING GUIDE

MAINTENANCE:

NU-VU® equipment is designed to last for years of useful service. Careful consideration is given in selecting components for durability, performance and ease of maintenance. For example, both the oven motor and proofer motor have sealed bearings and never need to be lubricated.

While NU-VU® equipment is designed for minimum care and maintenance; certain steps are required by the user for maximum equipment life and effectiveness:

- Proper installation of the equipment.
- Correct application and usage of the equipment.
- Dry-out Procedures performed daily.
- Thorough cleaning on a regular basis.

AUTOFILL Proofer Dry-Out Procedure - -

- A. The programmable controller has a proofer dry-out function incorporated for your convenience. Press the PROOFER DRYOUT key to initiate the dry-out function; you will be prompted as to whether or not to run the dry-out procedure. It is recommended that the dry-out procedure be performed any time the proofer will be off for more than a few hours.
- B. Wipe out any standing water in the bottom of the proofer.
- C. The proofer elements will turn on for 45 minutes to dry-out any remaining moisture, during this time the proofer door should be left open 1 to 2 inches.
- D. Empty, clean, and replace the drain pan beneath the proofer.
- E. After the 45 minutes, the proofer portion of the control will automatically turn off.

Oven Dry-Out Procedure - -

- A. Turn off the oven portion of the programmable controller.
- B. Leave the oven door open about 1 to 2 inches. The residual baking heat will dry out any moisture that may be trapped in the insulation or other components of the oven.
- C. Leave the oven door slightly open (about 1 to 2 inches) while the oven is not in use.
- D. The cooling fan will continue to run for approximately 5 minutes after both the oven and proofer portions of the programmable controller are turned off.

IMPORTANT: THESE DRY-OUT PROCEDURES MUST BE CARRIED OUT DAILY TO HELP MAINTAIN YOUR EQUIPMENT IN THE BEST POSSIBLE CONDITION. THE REMOVAL OF RESIDUAL MOISTURE HELPS PREVENT DETERIORATION OF THE INSULATION, DAMAGE TO THE PROOFER ELEMENTS, SENSORS, MOTOR AND OTHER ELECTRICAL COMPONENTS, AND EXTENDS THE USEFUL LIFETIME OF YOUR NU-VU® EQUIPMENT!

CLEANING:

Your QBT should be cleaned daily and as soon as possible after a spill has occurred. It is essential to maintain a clean unit, especially if the public views the unit in your place of business. The following should be used for cleaning:

- A. The stainless steel exterior may be cleaned with any good stainless steel cleaner or polish, or with hot soapy water followed by a clear rinse if it is very soiled.
- B. All glass should be cleaned with a glass-cleaning formula. Baked-on or excessive soiling can be removed with soap and hot water followed by a thorough rinse with fresh clean water.
- C. The oven and proofer interiors should be cleaned on a regular basis with mild soap and hot water followed by a thorough rinse with fresh clean water.

WARNING: Do not use oven cleaners in the oven!

Once in the side walls these cleaners are very difficult to remove, and may cause your oven to smoke or emit noxious fumes until they are rinsed out or burned away. You will need to completely disassemble the oven interior in order to flush out any remaining oven cleaner.

- D. Proofers equipped with AUTOFILL option should have the water pan inspected and cleaned at regular intervals as determined by usage and water hardness. To clean the water pan:
 1. Ensure that the Proofer is OFF prior to cleaning the water pan.
 2. Open proofer door, lift the right sidewall approximately 1/2" and swing towards the center of cavity to access the element cover and water pan.
 3. Clean scale build up from water pan and element with approved cleaner and rinse.
 4. Swing right ladder back, lift approximately 1/2" and hook on studs.

To prevent problems caused by accumulation of lime and mineral, clean the water pan every week.

***** CAUTION *****

NU-VU® DOES NOT RECOMMEND the use of any strong commercial or caustic product on this equipment. DO NOT allow any type of caustic cleaner to come into contact with any aluminum parts (such as door frames), the silicon rubber door gaskets, or any of the sealing compound in the oven and proofer seams and joints. These compounds may cause discoloration and degradation of these parts resulting in permanent damage. DO NOT use bleach or bleach compounds on any chromed parts; bleach will damage chrome plating. DO NOT CLEAN THIS APPLIANCE WITH A WATER JET OR PRESSURE WASHER.

NOTE:

NU-VU® has had very good results with a product called JIFFY CLEANER. For standard cleaning simply spray JIFFY on and wipe off. Heavily soiled areas may require a short period of soaking. This cleaner is available through NU-VU® (Part #51-0002) or through your local Rochester/Midland distributor or representative.

SERVICE AND REPLACEMENT GUIDE

Your QBT has been designed to be serviced quickly and easily. In fact, any individual who has average mechanical ability can do the work. Our Service Department is also available to you Monday through Friday from 7:00 a.m. to 5:00 p.m. (Central Standard Time) should you find yourself with a situation or problem other than what is outlined here. Call NU-VU® at (800) 338-9886 and ask for our Service Department to order replacement parts, ask questions, or offer comments.

This *SERVICE AND REPLACEMENT GUIDE* has been prepared to cover normal service problems. If this "trouble-shooting" information does not provide a solution for your particular problem we ask that you call us for direct assistance. Calling our Service Department before calling in a repair technician can usually save you both time and unnecessary expense, it is also required prior to any warranty work is performed. We want to do everything we can to minimize your "down-time".

You may need to remove an Access Panel for servicing. **DO NOT** allow any access panels to drop. When work on the component is finished replace the panel with care, making sure that all wires are properly placed and not pulled or pinched. If more than one component is being worked on try to remove only one component at a time.

***** NOTICE *****

NATIONAL SANITATION FOUNDATION (NSF) GUIDELINES REQUIRE THAT ALL INTERIOR PARTS BE REMOVABLE WITHOUT THE USE OF TOOLS. THIS EQUIPMENT HAS BEEN FACTORY ASSEMBLED TO SAFELY ACCOMMODATE ROUGH HANDLING THROUGH SHIPMENT AND ORIGINAL INSTALLATION. AFTER ANY MAINTENANCE, CLEANING OR REQUIRED SERVICE WORK, THE INTERIOR SHEET-METAL PARTS SHOULD BE REASSEMBLED AND FASTENED HAND-TIGHT ONLY, BUT STILL REMAIN TIGHT ENOUGH TO PREVENT ANY RATTLE OR MOVEMENT OF PARTS.

DOOR TEST PROCEDURE:

- A. Cut one or two strips of paper (do not use deli paper) approximately 1" wide and 8" - 10" long.
- B. Open the door slightly, insert a strip of paper between the gasket and door and close the door.

- C. Slowly pull the paper strip out. You should feel some resistance as you pull the strip from between the gasket and door of a properly adjusted door. Test the fit at regular 2" to 3" intervals around the entire Door.
 1. If you feel NO resistance at a particular spot the door is too loose.
 2. If you feel HEAVY resistance at a particular spot the door is too tight.

DOOR GASKET, How To Replace:

Follow these instructions to correctly and easily replace your door gasket with minimal problems. If you have any problems or questions please call the NU-VU® Service Department at (800) 338-9886 Monday through Friday from 7:00 a.m. until 5:00 p.m. for assistance.

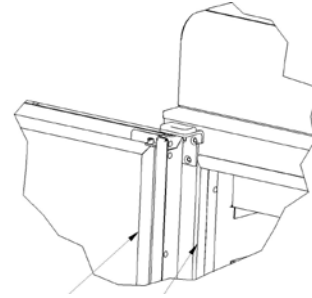

Fig. #6 – Door Gasket

Replacing the Oven Gasket - -

- A. Remove all pieces of the old gasket. Thoroughly clean (with soap and water) the door frame in the area of the new gasket installation. Remove any old sealant and any baked-on deposits.
- B. Replacement gasket for the oven door is supplied to you as a single formed piece of high-temperature material.
- C. Place the formed gasket over the channel in the face of the unit and press it firmly into place. Start at the corners and work toward the center.
- D. The replacement gasket requires nothing further. You may begin using your oven as soon as the gasket has been installed.

Replacing the Proofer Door Gasket - -

- A. Remove all pieces of the old gasket. Thoroughly clean the door frame in preparation for the new installation. Remove any old sealant, bits of gasket and baked-on deposits.
- B. Replacement gasket for the proofer door is supplied to you as a single formed piece of high-temperature material.
- C. Place the formed gasket over the channel in the face of the unit and press it firmly into place. Start at the corners and work toward the center.
- D. The replacement gasket requires nothing further. You may begin using your proofer as soon as the gasket has been installed.

NU-VU® EQUIPMENT WARRANTY

NU-VU® products are warranted against defects in workmanship and materials from the original date of shipment only. NU-VU® does not warrant against any damage that may occur during shipment or storage of the equipment. Any claim for such damage must be filed against the carrier or storage company. No other express warranty, written or oral, applies. No person is authorized to give any other warranty or assume any other liability on behalf of NU-VU®, except by written statement from an officer of NU-VU®.

Your NU-VU® equipment warranty is limited to the following time periods for the original owner only:

| | <u>PARTS</u> | <u>LABOR</u> |
|-------------------------------------|--------------|--------------|
| Inside the United States and Canada | 24 Months | 12 Months |
| All other areas | 24 Months | 12 Months |

These time limits will apply in all cases unless prior arrangements have been made and agreed to in writing.

The NU-VU® equipment warranty is composed of the following:

PARTS:

This limited warranty covers certain electrical, electronic and mechanical parts for the time periods shown above with the exception of those items detailed under Warranty Limitations. Customers who maintain an open account may purchase against their account. MasterCard, Visa and American Express credit cards are also accepted.

The return of defective parts is required. An RGA # is require for parts being returned. The return of a defective part or component must be made prior to the issuance of a credit on an open account. If a part that is returned tests satisfactory in the NU-VU® factory or at an authorized NU-VU® dealer or service agency, NU-VU® may withhold issuing credit. Replacement parts will be warranted for a period of *ninety (90) days* provided they are installed and used in a manner authorized by NU-VU®.

LABOR:

We require that you call our NU-VU® Service Department at (800) 338-9886 for service authorization BEFORE any service is performed if you wish to claim a labor expense under this warranty. We may be able to solve your problem over the telephone, or we will schedule a warranty service call by a reliable service agency in your area.

This warranty covers the replacement and installation of parts and components which are included under **PARTS** for the time period listed above. This coverage is limited to the normal mileage allowance for a maximum travel radius of up to fifty (50) miles, and the normal labor rate times the allowable hours for performing the work as set forth in the following listing:

STANDARD TIME ALLOWANCES FOR WARRANTY REPLACEMENTS

| <u>Change performed</u> | <u>Change time</u> | <u>Test time</u> | <u>Total time</u> |
|-------------------------|--------------------|------------------|-------------------|
| Oven heating element | 1 hr. | ½ hr. | 1½ hr. |
| Oven motor | 1 hr. | ½ hr. | 1½ hr. |
| Programmable controller | ½ hr. | ½ hr. | 1 hr. |
| Control sensor | ½ hr. | ½ hr. | 1 hr. |
| Proofer heating element | ½ hr. | ½ hr. | 1 hr. |
| Contactore | ½ hr. | 5 min. | ½ hr. |
| Proofer motor | ½ hr. | 5 min. | ½ hr. |

These times are based on servicing a unit that has been installed with allowance made for access panels on the unit. If the unit is built into a wall that makes servicing very difficult or impossible without removing part of the counter, wall, trim, etc., the extra time for gaining access shall be charged to the owner of the unit. NU-VU® has determined that the listed times, which are based on the period necessary for a trained service person to perform the work noted, are fair and reasonable. If a problem is not diagnosed within a half-hour, the service person must contact the NU-VU® Service Department via telephone. Additional time for problem solving will not be allowed unless this procedure is followed. An appointment for servicing a unit should be set up since time will not be allowed for waiting to service a unit. Unless the service person justifies extra time for performing the work noted, charges for work performed by the service person in excess of the allowed time shall either be billed to the owner of the equipment or denied.

IMPORTANT: NU-VU WILL NOT PAY FOR ANY SERVICE CALLS AS WARRANTY WORK IF A NU-VU® AUTHORIZED SERVICE AGENCY DETERMINES THAT YOUR EQUIPMENT IS SET UP AND OPERATING PROPERLY!

WARRANTY LIMITATIONS:

NU-VU® will pay for parts and labor under warranty if there is a defective component, but not for:

- Normal operational wear and tear on the following parts -
 - ┌ Light bulbs
 - ┌ Door gaskets
 - ┌ Door handles and catches
 - ┌ Fuses
- Damage attributable to customer abuse, including -
 - ┌ Proofer water pan allowed to run dry and burn.
 - ┌ Proofer fan motor damaged from not following outlined DRYOUT procedure.
 - ┌ Lack of regular cleaning or maintenance.
- Power supply problems, including -
 - ┌ Insufficient or incorrect voltage.
 - ┌ Damage to electrical components caused by a power surge or spike.
 - ┌ Incorrect installation (i.e., equipment not supplied with separate neutral or ground as required, or incorrect location of high-voltage power leg for 240-volt 3-phase units).
 - ┌ Damage to electrical components resulting from use of an incorrect power supply cord or circuit breaker.
- Operational problems resulting from customer's failure to follow established procedures outlined in the Owner's Manual.
- A service call if nothing is found to be wrong (any returned parts work as per spec when tested).
- Recalibration of temperature and humidity controls (all controls are carefully calibrated and tested at our facility before shipment).
- Any equipment moved from the place of original installation unless NU-VU® agrees in writing to continue the warranty after the relocation.
- Ongoing operational adjustments due to changing environmental conditions or normal wear and tear.
- Any overtime charges. NU-VU® will pay straight time only for any work performed on NU-VU® equipment.

Products must be installed and maintained in accordance with NU-VU® instructions. Users are responsible for the suitability of the products to their application. There is no warranty against damage resulting from accident, abuse, alteration, misapplication, inadequate storage prior to installation, or improper specification or other operating conditions beyond our immediate control. Claims against carrier damage in transit must be filed by the buyer; therefore, the buyer **must inspect** the product immediately upon receipt.

THE USE OF NON-OEM REPLACEMENT PARTS WITHOUT PRIOR EXPRESSED WRITTEN AUTHORIZATION FROM NU-VU® WILL VOID ANY AND ALL WARRANTIES.

***THIS WARRANTY DOES NOT COVER ADJUSTMENTS
DUE TO NORMAL ON-GOING USE OF THE UNIT!!!***

PARTS RETURN PROCEDURE AND CONDITIONS:

The following procedure shall be followed for the return of parts to the factory for credit consideration:

- All parts received by NU-VU® must have a completed RETURN AUTHORIZATION FORM as supplied by NU-VU® with the replacement part. An RGA # is require for parts being returned.
- Package all return parts securely so that in-transit damage cannot occur.
- Prepay shipment. Any parts returned collect will be refused by our receiving department. Credit will be considered on proper returns only.
- As soon as parts are tested and confirmed to be defective credit will be issued against them.
- If the engineering test shows the component is not defective and is in good working condition it may be returned to you along with your request for payment.

Please use this space to record the MODEL NUMBER and complete 12-digit SERIAL NUMBER from the nameplate on the side of your NU-VU® equipment. You will need both of these numbers if you ever need to contact our Service Department concerning adjustments, replacement parts or other service.

MODEL NUMBER: QBT-4/8 or QBT-5/10 (Select Model)

SERIAL NUMBER: _____ (12 Digits)

