

FHX1562
INDOOR UNIT

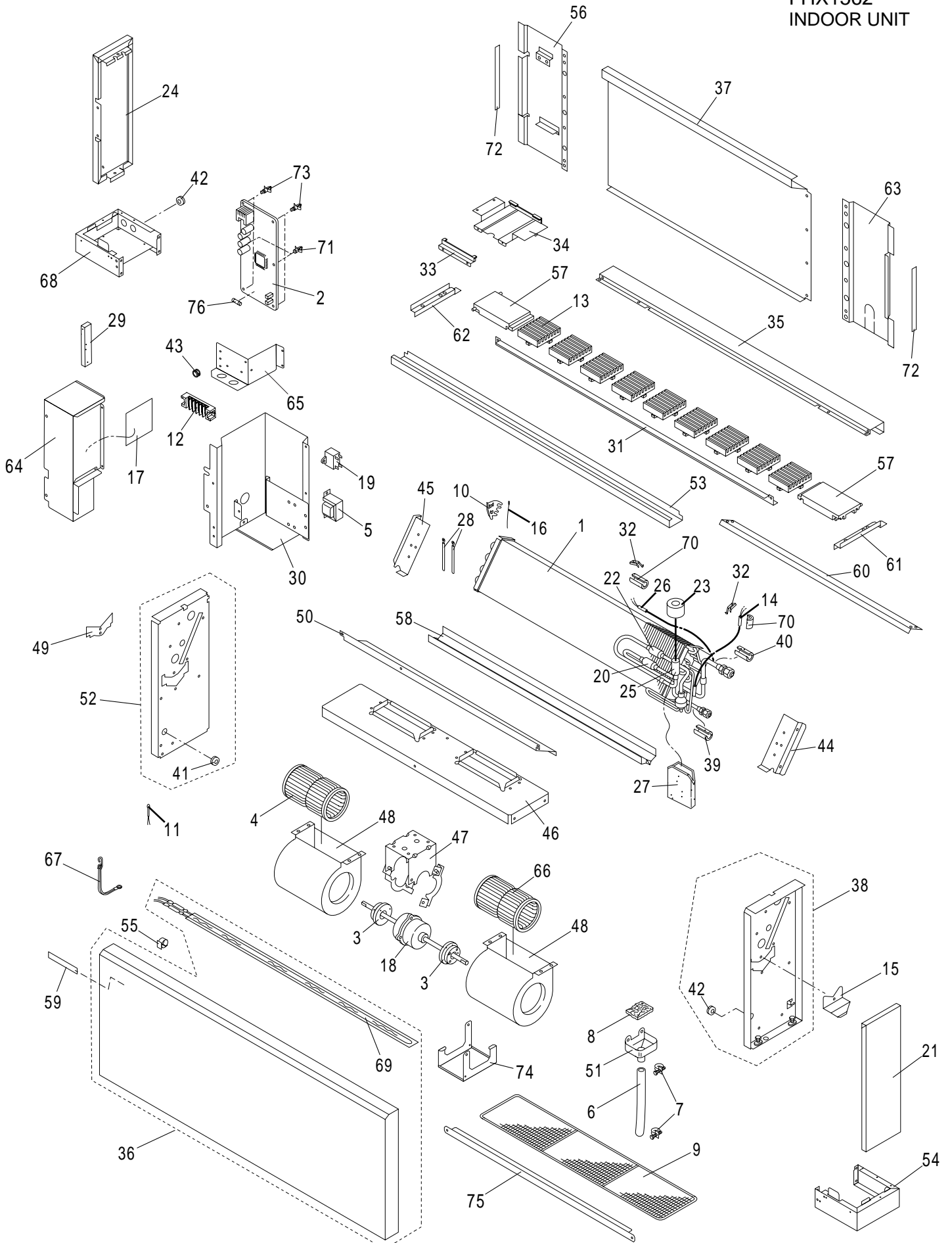

ATTENTION !

To ensure correct parts supply, please let us know followings,
when you make service parts order:

1.Part No. 2.Description 3.Q'ty 4.Volts-Hz-Ph 5.Product Model No.

FHX1562
INDOOR UNIT

KeyNo.	Part No.	Description	Q'ty	Reference No.
* 1	623 188 4532	Heat Exch Ass'y	1	854-0-4124-52300
* 2	623 311 8130	Controller Ass'y CR-UHX0762	1	854-9-9536-05710
3	623 103 5873	Cushion Rubber	2	854-2-2534-14800
4	623 005 2307	Centrifugal Fan Ass'y	1	343-0-2506-11100
* 5	623 311 8444	Transformer Ass'y ATR-IL224B-T-R	1	8FA-0-5263-08500
6	623 123 3477	Drain Hose	1	854-2-4297-13400
7	623 028 0229	Band	2	821-2-8206-10102
8	623 099 0180	Strainer	1	343-2-2348-13400
9	623 312 6081	Frame Filter Ass'y	1	854-0-1302-22710
10	638 012 1830	Mounting Thermistor	1	826-2-5303-11200
* 11	623 311 8482	Thermistor Ass'y(TA) KTEC-35-S6	1	8FA-0-5259-48500
* 12	623 303 8087	Terminal Base HP-T3052-1-6P	1	1FA-4-J3A0-34500
13	623 311 8475	Grille Supply	9	343-2-1503-10610
* 14	623 311 8734	Thermistor Ass'y(E1) PB2M-41E-S9	1	8FA-0-5259-47700
15	638 009 9511	Mounting Plate	1	854-2-2361-23501
* 16	623 311 8451	Thermistor Ass'y(BL) KTEC-35-S85	1	8FA-0-5259-47600
17	623 311 8512	Elec. Wiring Diagram	1	8FA-2-5250-68000
* 18	623 311 8758	Fan Motor Ass'y KFG4Q-61C6P	1	8FA-0-5202-08700
* 19	623 311 8741	Fixed Capacitor CMPS UP44B205JMF	1	1FA-4-C1A0-15200
20	623 175 2220	Strainer Ass'y	1	854-0-4522-29200
21	623 099 0234	Side Panel	1	343-2-1103-15201
22	623 175 2213	Strainer Ass'y	1	854-0-4522-29100
* 23	623 175 2206	Magnetic Coil(PMV) UKV-U030E	1	1FA-4-L8A0-30500
24	623 113 6693	Side Panel	1	854-2-1102-41801
* 25	623 175 2336	Solenoid Control Valve UKV-25D32	1	854-2-4548-20300
* 26	623 311 8765	Thermistor Ass'y(E3) PB2M-41E-S2	1	8FA-0-5259-47800
27	638 020 7220	Vibration Insulation	1	854-2-2475-17200
28	628 012 9219	Fixture Cord	2	731-2-5323-12000
29	623 113 7089	Insulation	1	854-2-2402-18500
30	623 311 8529	Elec Component Box Ass'y	1	854-0-5311-14801
31	638 021 3979	Angle flange	1	854-2-2306-28001
32	623 148 5876	Mounting Thermostat	2	852-2-5303-22401
33	623 175 2275	Mounting Plate	1	854-2-1129-972H1
34	623 175 2268	Mounting Plate	1	854-2-1129-973H1
35	623 311 8802	Angle flange	1	854-2-2306-276H2
36	623 311 8796	Front Panel Ass'y	1	854-0-1101-486H2
37	623 311 8789	Rear Panel	1	343-2-2204-229H2
38	623 311 8567	Frame Ass'y	1	854-0-2202-148H6
39	623 160 8206	Insulation Special	1	854-2-2411-24110
40	623 311 8772	Insulation Special	1	854-2-2410-75710

NOTE: Metal and plastic parts will be supplied basically with necessary heat insulation pads or packing. Each key number with an asterisk (*) means the recommended service parts.

ATTENTION !

To ensure correct parts supply, please let us know followings,
when you make service parts order:

1.Part No. 2.Description 3.Q'ty 4.Volts-Hz-Ph 5.Product Model No.

FHX1562
INDOOR UNIT

KeyNo.	Part No.	Description	Q'ty	Reference No.
41	623 000 0773	Eyelet	1	3-9041-01801
42	623 000 0865	Eyelet	2	3-9041-11000
43	623 038 3425	Bushing OCB-875	1	851-2-5370-00900
44	623 113 6822	Mounting Plate,Evaporator	1	854-2-2303-26200
45	623 113 6839	Mounting Plate,Evaporator	1	854-2-2303-26300
46	623 311 8819	Partition Plate Ass'y	1	854-0-2516-168H2
47	623 005 2444	Base Ass'y Fan Moter	1	343-0-2511-11501
48	623 005 2550	Fan Casing Ass'y	2	343-0-2513-10800
49	623 311 8659	Stopper	1	343-2-2338-117H2
50	623 311 8833	Mounting Plate,Evaporator	1	854-2-2303-266H2
51	623 311 8635	Drain Pan	1	343-2-2304-104H3
52	623 311 8628	Frame Ass'y	1	854-0-2202-147H4
53	623 311 8826	Angle flange	1	854-2-2306-233H2
54	623 099 0654	Base	1	343-2-2309-12001
55	623 082 1378	Support Wire	1	854-2-5319-10800
56	623 174 3662	Rear Panel Ass'y	1	854-0-1103-150H1
57	623 311 8680	Cover, Switch	2	343-2-1116-106H3
58	623 311 8840	Drain Pan	1	343-2-2302-281H3
59	623 125 7770	Badge	1	854-2-1354-22801
60	623 113 7638	Mounting Plate Ass'y	1	854-2-2208-25701
61	623 099 0630	Angle	1	343-2-2306-36301
62	623 099 0647	Angle	1	343-2-2306-36401
63	623 113 6716	Rear Panel	1	854-2-1103-20000
64	623 312 6043	Cover Ass'y	1	854-0-2325-51301
65	623 311 8710	Support Terminal	1	854-2-5316-24001
66	623 005 2321	Centrifugal Fan Ass'y	1	343-0-2506-11400
67	623 311 8703	Mounting Parts Ass'y	1	854-0-1111-28400
68	623 312 6050	Bottom Plate Ass'y	1	854-0-2204-68601
* 69	623 311 8857	Heater (240V,15W)	1	8FA-0-5255-06800
70	623 101 9118	Insulation, Thermostat	2	854-2-4312-13100
71	623 099 6052	Spacer SPSN-6	2	851-2-5366-04200
72	623 132 8036	Packing	2	854-2-1361-24600
73	623 097 1677	Spacer SPLSN-6	4	851-2-5366-03800
74	623 312 6104	Mounting Plate	1	854-2-2362-51801
75	623 312 6098	Mounting Plate Ass'y	1	854-2-2208-48902
76	423 033 1606	Fuse ET 5A	1	F31S5R0A2SCTR
	623 311 7140	Operation Manual	1	854-6-4609-01800

NOTE: Metal and plastic parts will be supplied basically
with necessary heat insulation pads or packing.
Each key number with an asterisk (*) means the
recommended service parts.

For Parts or Service Assistance please contact your local Sanyo HVAC Contractor or Distributor

United States: SCS, HVAC Solutions

Web: www.SanyoHVAC.com

Parts: hvac.parts@sna.sanyo.com

Service: hvac.service@sna.sanyo.com

Canada: Sanyo Canada Inc.

Web: www.SanyoHVAC.com

Parts/Service: hvac@sci.sanyo.com

Nov / '09 Printed in Japan