

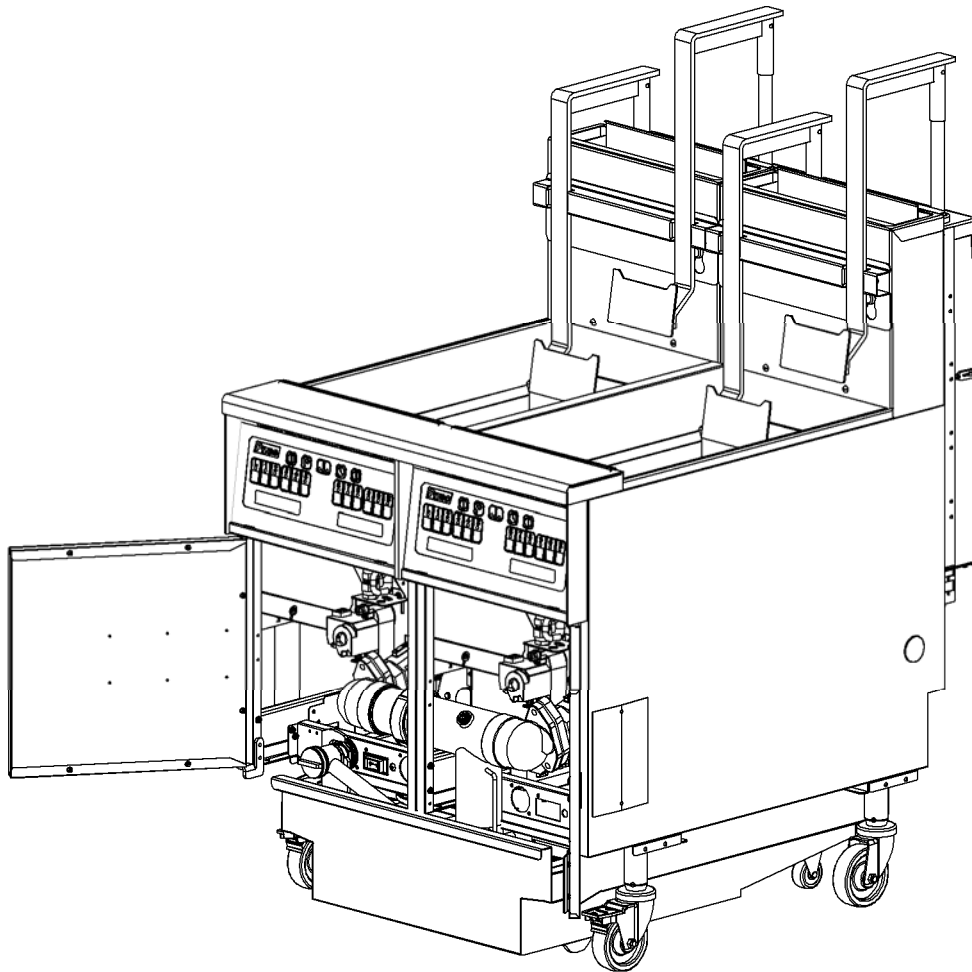

# Solstice and Solstice Supreme High Efficiency Gas Fryers SG/SSH Series



## Notice

---

In the event of problems or questions about your order, contact the Pitco Frialator factory at (603) 225-6684.

In the event of problems or questions about your equipment, contact the Pitco Frialator Authorized Service and Parts representative (ASAP) covering your area, or contact Pitco at the numbers listed above.

### MAILING ADDRESS

Pitco Frialator  
P.O. Box 501  
Concord, NH 03302-0501

### SHIPPING ADDRESS

Pitco Frialator  
10 Ferry Street  
Concord, NH 03301

|   |
|---|
| <b>EQUIPMENT REFERENECE INFORMATION</b> |
| <b>Model #:</b> _____                   |
| <b>Serial #:</b> _____                  |
| <b>Date Purchased:</b> _____            |

# Table of Contents

---

|  |           |
|--|-----------|
| <b>Theory of Operation .....</b>                         | <b>6</b>  |
| <b>Fryer Components Operation.....</b>                   | <b>7</b>  |
| Heating System .....                                     | 7         |
| Safety System.....                                       | 8         |
| Filter System .....                                      | 8         |
| Optional Basket Lift.....                                | 8         |
| Controller Operational Modes .....                       | 9         |
| Serial Numbers.....                                      | 10        |
| <b>24V Model .....</b>                                   | <b>11</b> |
| <b>Accessing Fryer for Servicing.....</b>                | <b>12</b> |
| <b>Cleaning the Gas Valve Vent Tube .....</b>            | <b>13</b> |
| <b>Checking the Burner Manifold Gas Pressure .....</b>   | <b>14</b> |
| Taking a Supply Gas Pressure Reading.....                | 14        |
| Removing Solid State Thermostat (If Necessary) .....     | 16        |
| Taking a Manifold Gas Pressure Reading .....             | 17        |
| Adjusting Manifold Gas Pressure .....                    | 18        |
| Adjusting Pilot Pressure.....                            | 18        |
| Calibrating Solid State Thermostat.....                  | 19        |
| <b>Replacing the Controllers and Wiring Harness.....</b> | <b>20</b> |
| Removing the Controller Front Panel Bezel.....           | 20        |
| Removing the Solid State Wiring Harness .....            | 21        |
| <b>Replacing the Relay Board and Paper.....</b>          | <b>23</b> |
| <b>Replacing the Ignition Module .....</b>               | <b>24</b> |
| <b>Replacing the Spinal Tap .....</b>                    | <b>25</b> |
| <b>Replacing an Igniter/Pilot Assembly .....</b>         | <b>28</b> |
| <b>Replacing the Self-Cleaning Burner Solenoid.....</b>  | <b>30</b> |
| <b>Replacing the Gas Valve.....</b>                      | <b>31</b> |
| <b>Replacing the Transformer Box .....</b>               | <b>33</b> |
| <b>Replacing the DVI Switch .....</b>                    | <b>35</b> |
| <b>Replacing the Burner Assembly .....</b>               | <b>36</b> |
| Replacing the Burner(s).....                             | 36        |
| Replacing the Burner Assembly .....                      | 38        |
| <b>Replacing the Frypot .....</b>                        | <b>40</b> |
| <b>Replacing the Basket Lift Components.....</b>         | <b>44</b> |
| Removing the Basket Lift Cover .....                     | 44        |
| Replacing the Transformer .....                          | 44        |
| Replacing the Basket Lift Driver Board .....             | 45        |
| Adjusting the Magnetic Sensor.....                       | 46        |
| Replacing the Basket Lift Actuator.....                  | 46        |
| <b>Gas Conversion .....</b>                              | <b>49</b> |

|   |           |
|---|-----------|
| <b>mV Model .....</b>                                     | <b>50</b> |
| <b>Accessing Fryer for Servicing .....</b>                | <b>51</b> |
| <b>Cleaning the Gas Valve Vent Tube .....</b>             | <b>51</b> |
| <b>Checking the Burner Manifold Gas Pressure .....</b>    | <b>51</b> |
| Taking an Incoming Supply Gas Pressure Reading.....       | 51        |
| Taking a Manifold Gas Pressure Reading .....              | 52        |
| Adjusting Manifold Gas Pressure .....                     | 53        |
| <b>Measuring Thermopile .....</b>                         | <b>54</b> |
| Taking a Millivolt Reading.....                           | 54        |
| Adjusting the Thermopile .....                            | 54        |
| <b>Replacing the Thermostat .....</b>                     | <b>55</b> |
| Calibrating the Thermostat .....                          | 57        |
| <b>Replacing the Hi-Limit Thermostat .....</b>            | <b>58</b> |
| <b>Filter System .....</b>                                | <b>59</b> |
| <b>Replacing the Return Valve .....</b>                   | <b>60</b> |
| <b>Replacing the Flush Hose Assembly and Valve .....</b>  | <b>61</b> |
| <b>Replacing the Heat Tape .....</b>                      | <b>64</b> |
| <b>Replacing the Waste Oil and Components .....</b>       | <b>65</b> |
| Removing Rear Mounting Bracket.....                       | 65        |
| Removing the Check Valve .....                            | 66        |
| <b>Replacing the Filter Pump and Motor .....</b>          | <b>68</b> |
| Removing the Filter Pump and Motor .....                  | 68        |
| Replacing Seal Kit .....                                  | 70        |
| Removing the Filter Pump from the Motor .....             | 71        |
| <b>Replacing the Return Switch .....</b>                  | <b>72</b> |
| <b>Replacing the Drain Line or Gasket.....</b>            | <b>74</b> |
| <b>Replacing the Pump Relay and Circuit Breaker .....</b> | <b>75</b> |
| Replacing the Circuit Breaker.....                        | 75        |
| Replacing the Pump Relay.....                             | 76        |
| <b>Troubleshooting and Problem Isolation .....</b>        | <b>77</b> |
| <b>Troubleshooting and Problem Isolation .....</b>        | <b>78</b> |
| Interpretation of Solid State Controller Lights .....     | 78        |
| Solid State Thermostat Field Calibration.....             | 79        |
| <b>Component Troubleshooting .....</b>                    | <b>80</b> |
| Probe .....   | 80        |
| Roll Out Switch.....                                      | 80        |
| Gas Valve.....  | 80        |
| Hi-Limit .....  | 80        |
| Drain Valve and Return Valve Switches .....               | 81        |
| Transformer.....  | 81        |
| Ignition Module .....                                     | 81        |
| Relay Board .....   | 81        |
| Computer Control .....                                    | 82        |

|   |           |
|---|-----------|
| Digital Solid State Control.....              | 82        |
| Primary Solid State Control.....              | 83        |
| Backup Solid State Control.....               | 83        |
| Optional Basket Lift.....                     | 84        |
| Probe Resistance Chart.....                   | 85        |
| Orifice Size Chart.....                       | 86        |
| Orifice Size at Sea Level Chart.....          | 87        |
| <b>Wiring Diagrams .....</b>                  | <b>88</b> |
| <b>Simplified Wiring Diagrams .....</b>       | <b>89</b> |
| Wiring Diagram – Full Vat with SCB .....      | 89        |
| Wiring Diagram – Twin Vat with SCB .....      | 90        |
| Wiring Diagram – Basket Lifts.....            | 91        |
| Wiring Diagram – Filter Motor 115V-60Hz.....  | 92        |
| Wiring Diagrams – Filter Motor 208-240V ..... | 93        |

# Theory of Operation

## Fryer Components Operation

---

The SG and SSH fryer components function in specific order of operation. Knowing and understanding the sequence of fryer and components operation enables you to diagnose equipment failure more accurately.

### Heating System

---

The unit is connected to line voltage:

- If Fuse F1 on the relay board is good:
  - The A.C. indicator is illuminated.
  - The controller is supplied with 24 VAC.
  - With the drain valve handle closed, the proximity switch supplies 24 VAC to the drain valve interlock (DVI) input at the controller.
  - 24 VAC is at the Side On (SO) relay COM contact.
- The controller is turned ON:
  - The SO indicator on the relay board is illuminated.
  - The SO relay is energized, closing the circuit.
  - With the roll out switch and hi-limit in the closed position, the ignition module receives 24VAC at terminal 6 (24 VAC).
- The ignition module:
  - Sends 24 VAC from terminal 3(PV) to the PV terminal on the gas valve.
  - Sends the igniter 15kv to spark.
  - Senses the flame once the pilot has lit and it sends 24 VAC at terminal 1(MV) and puts 24 VAC at the Heat Demand (HD) relay COM contact on the relay board. The HD relay on the relay board interrupts the 24 VAC supply to the gas valve until the controller calls for heat.

**NOTE: When the controller is on, the pilot should always remain lit.**

- The controller calls for heat:
  - The HD indicator on the relay board is illuminated.
  - The HD relay is energized, closing the circuit sending 24 VAC to the MV terminal on the gas valve.
  - The computer is supplied with a 24 VAC heat feedback (HFB) signal.

## Safety System

---

When the roll out switch or hi-limit trips, it interrupts the 24 VAC supply to the ignition module.

- When the controller calls for heat, it does not receive a 24 VAC HFB. With approximately 90 seconds of HFB loss, the controller indicates an ignition failure or heat failure.
- After the roll out switch hi-limit is reset, turn the controller off and then back on for the unit to heat.

## Filter System

---

- Opening the RED return valve handle:
  - Opens the return valve to that vat.
  - Closes the pump proximity switch causing the “pump run” relay to be energized.
  - The pump motor begins to run.
- Closing the return valve handle de-energizes the relay and the pump motor stops running and the return valve closes.
- The pump system is equipped with a circuit breaker which de-energizes the system and the heat tape in the event of over current. The circuit breaker must be in the “ON” position for the pump and heat tape to operate.

**NOTE: Circuit Breaker should remain in the “ON” position at all times.**

- The return piping system may be provided with optional heat tape to prevent solidification of solid shortening. The heat tape is low wattage and is on constantly to maintain liquid shortening in the line.

## Optional Basket Lift

---

The basket lift is a self contained unit that requires a 120V, 208V, or 240V supply. With most fryer configurations, the power is supplied from the entrance box at the back of the fryer, but some configurations require power directly from a wall outlet.

- When power is supplied to basket lift assembly, the baskets lift to the up position.
- The baskets lower with a 24 VDC output from the controller.
- The basket lift control voltage is supplied from the controller
- The basket lift operational voltage is supplied from the line voltage supply that powers the transformer in the basket lift assembly.

## Controller Operational Modes

| MODE            | ENTRY   | INDICATION  | TEMPERATURE SET POINT | EXIT                      |            |     |       |        |      |       |        |  |   |
|-----------------|---|---|-----------------------|---------------------------|------------|-----|-------|--------|------|-------|--------|--|---|
| <b>BOIL OUT</b> | With control initially off, toggle the <b>ON/OFF</b> switch:<br><b>ON – OFF – ON – OFF – Then ON</b><br>This sequence must be performed within 3 seconds. | Power and HD indicators are on. HFB indicator flashes at 0.5 seconds rate until exit.   | Fixed at 200°F (93°C) | Press <b>OFF</b> to exit. |            |     |       |        |      |       |        |  |   |
| <b>MELT</b>     | Select <b>MELT</b> and then press <b>ON</b> .<br>Melt may be bypassed by pressing <b>COOK</b> .   | Same as below except fixed heat cycle.<br><table border="1" style="margin-left: auto; margin-right: auto;"> <thead> <tr> <th></th> <th><b>ON</b></th> <th><b>OFF</b></th> </tr> </thead> <tbody> <tr> <td>GAS</td> <td>8 sec</td> <td>22 sec</td> </tr> <tr> <td>ELEC</td> <td>4 sec</td> <td>26 sec</td> </tr> </tbody> </table> |                       | <b>ON</b>                 | <b>OFF</b> | GAS | 8 sec | 22 sec | ELEC | 4 sec | 26 sec | No set point. HD is suppressed if Vat is greater than 250°F (121°C). | Automatic switch to <b>COOK</b> after temperature is greater than 140°F (60°C) or press <b>OFF</b> to exit. |
|                 | <b>ON</b>   | <b>OFF</b>  |                       |                           |            |     |       |        |      |       |        |  |   |
| GAS             | 8 sec   | 22 sec  |                       |                           |            |     |       |        |      |       |        |  |   |
| ELEC            | 4 sec   | 26 sec  |                       |                           |            |     |       |        |      |       |        |  |   |
| <b>COOK</b>     | Press <b>COOK</b> and then press <b>ON</b> .<br>Automatic entry after completed <b>MELT</b> cycle.  | Power indicator is on. HD as required to maintain Vat temperature. HFB indicator follows HD.  | Knob setting          | Press <b>OFF</b> to exit. |            |     |       |        |      |       |        |  |   |

## Serial Numbers

---



### Serial Numbers

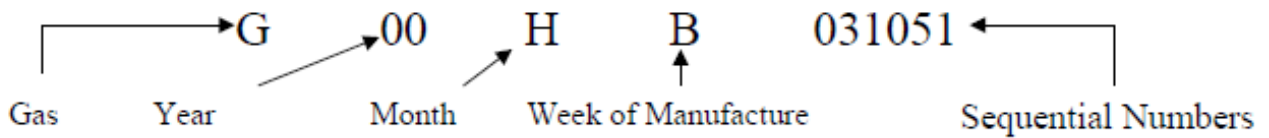

G = Gas      All Models of Gas Fryers & Broilers

E = Electric      All Models of Electric Fryers

F = Filters      All Filters

#### Months

A=January

B = February

C = March

D = April

E=May

F= June

G=July

H= August

J=September

K=October

L=November

M=December

# 24V Model

## Accessing Fryer for Servicing

---

1. Press off button on control panel.



2. Slide button to solid state.



3. Shut off the individual gas supply line.

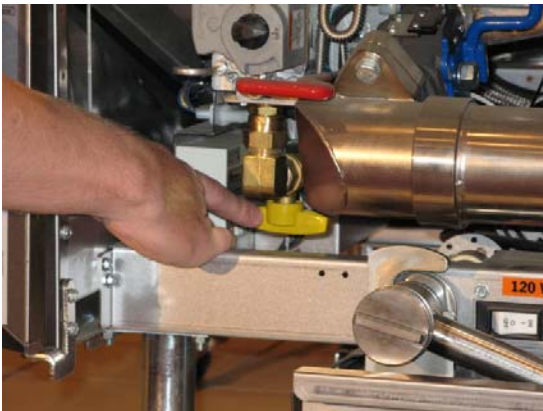

4. Unplug all power cords.



5. Shut off the main gas supply line to the unit.



6. Pull back collar to remove the quick disconnect gas line.

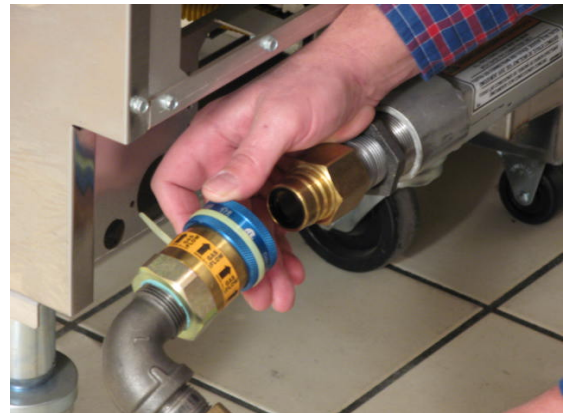

## Cleaning the Gas Valve Vent Tube

---

1. Bend the gas valve vent tube to allow for removal.



2. Loosen nut at the base of the vent tube with a 3/8 inch open-ended wrench and then remove.

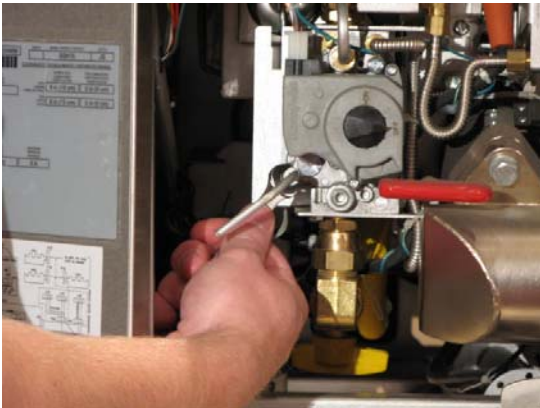

3. Clean the tube (not shown) and reinstall.

**NOTE:** Make sure the vent tube is not reinstalled in an upright position and there are no kinks in the tube.

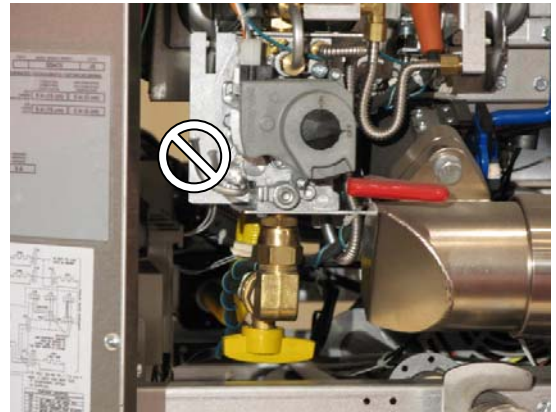

## Checking the Burner Manifold Gas Pressure

---

### Taking a Supply Gas Pressure Reading

---

1. Unscrew and remove the gas supply plug with a 3/16 inch hex wrench.
3. Finish tightening the test fitting using a 7/16 inch open-ended wrench.

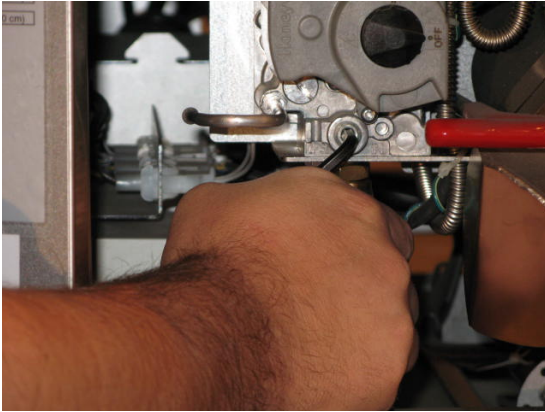

2. Finger tighten the test fitting into the test port.

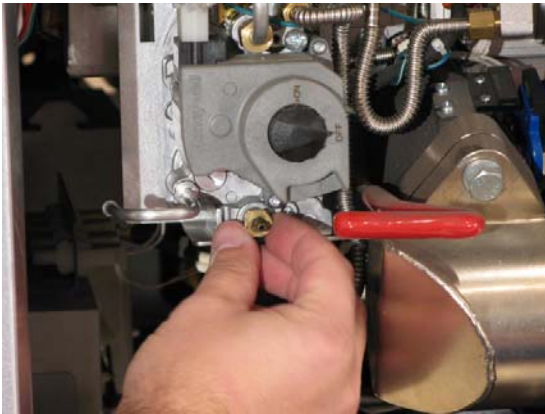

3. Finish tightening the test fitting using a 7/16 inch open-ended wrench.

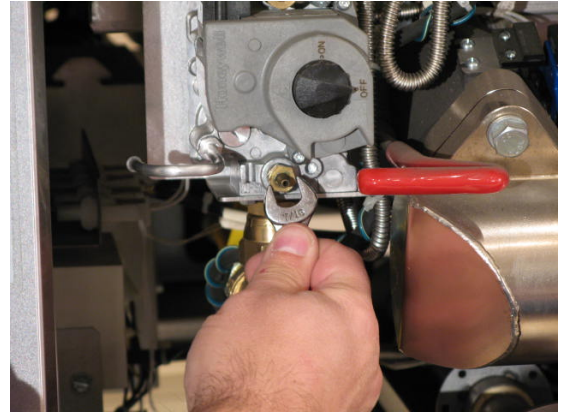

4. Connect the manometer.

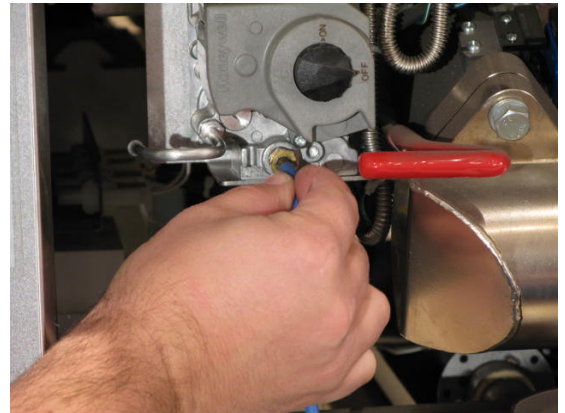

5. Turn on the main gas supply line.

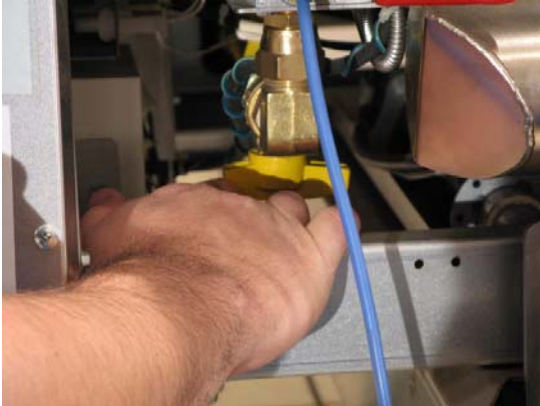

6. Check the supply gas pressure with the manometer and compare the reading to the supply gas pressure table to determine what the incoming gas pressure should be.

**Supply Pressure Table**

| NAT    | LP       |
|--------|----------|
| 7 to 9 | 11 to 13 |

**NOTE:** You cannot adjust the supply gas pressure at the unit. Anything over/under the recommended amount should be adjusted at the facility's main gas line.

7. Shut off the main gas supply line.
8. Disconnect the manometer.
9. Remove the test fitting.

10. Apply Fluoropolymer paste to gas supply plug.

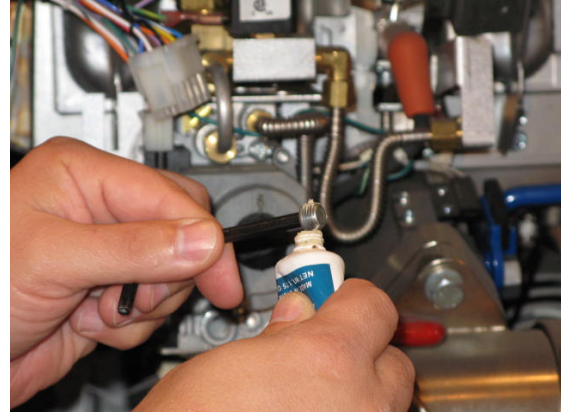

11. Reinstall gas supply plug with a 3/16 inch hex wrench.

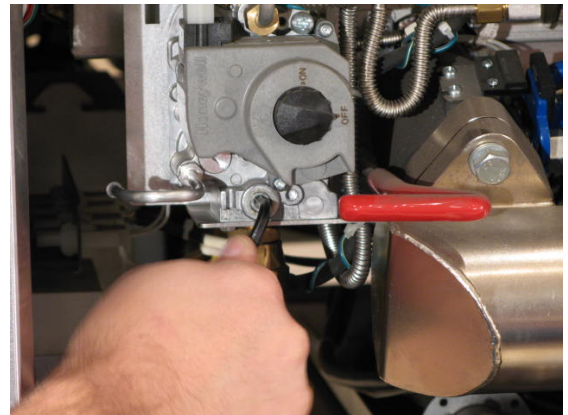

12. Turn on the main gas supply line.

## Removing Solid State Thermostat (If Necessary)

---

1. Remove the two (2) screws, which hold the solid state thermostat, with a 5/16 inch socket.

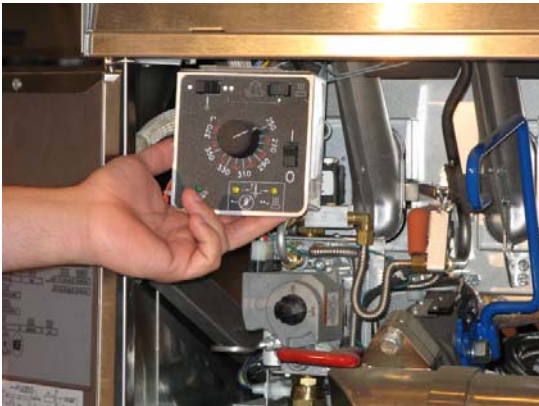
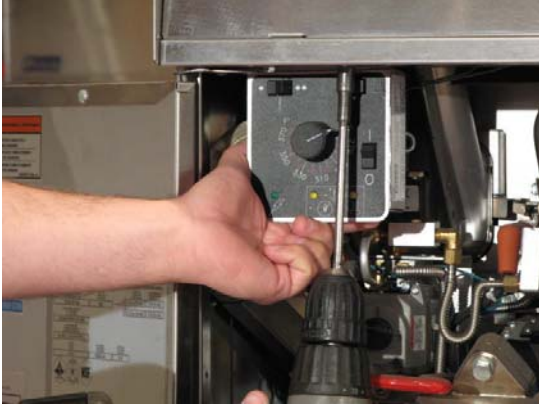

2. Disconnect solid state thermostat control harness.



## Taking a Manifold Gas Pressure Reading

---

1. Unscrew and remove the gas manifold plug with a 3/16 inch hex wrench.

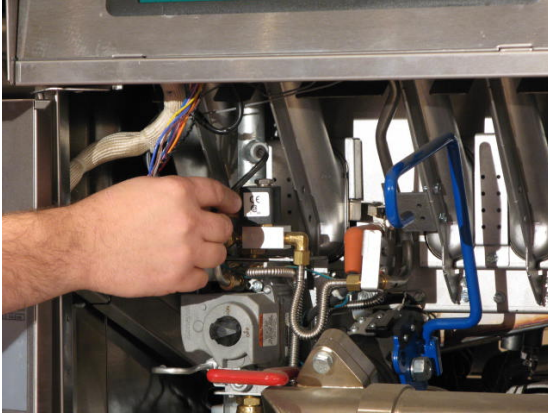

2. Finger tighten the test fitting into the test port.



3. Finish tightening the test fitting using a 7/16 inch open-ended wrench.



4. Connect the manometer.



5. If necessary, reconnect the solid state thermostat (reverse steps for "Removing Solid Stats Thermostat" on page 16.

## Adjusting Manifold Gas Pressure

---

1. Check the manifold gas pressure with the manometer and compare the reading to the manifold gas pressure table.

**Manifold Gas Pressure Table**

| NAT  | LP  |
|------|-----|
| 4.0" | 10" |

2. Insert a flathead screwdriver into the cap and turn counter-clockwise to remove it.

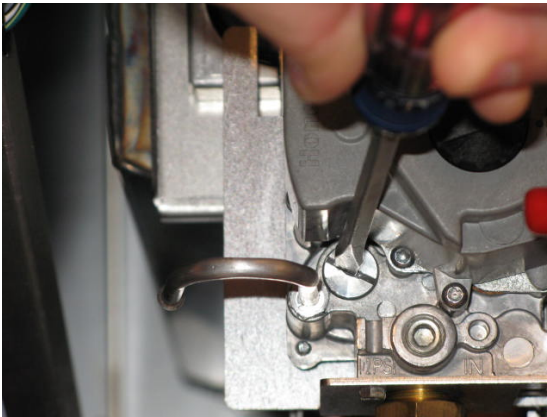

3. Insert flathead screwdriver into the cap and turn counter-clockwise to increase the gas pressure or clockwise to decrease the gas pressure.

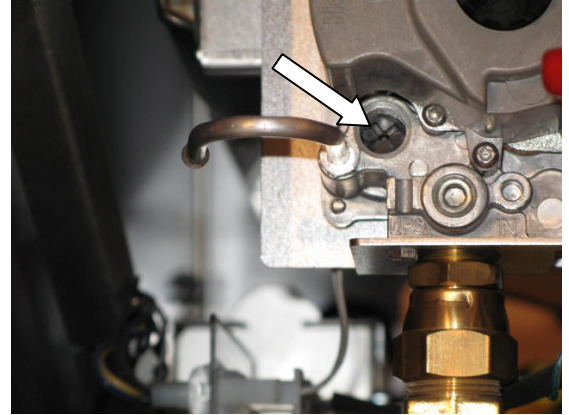

4. When adjustment is complete:
  - a. Disconnect the manometer.
  - b. Remove the test fitting.
  - c. Reinstall the gas manifold plug.
  - d. Reconnect solid state thermostat.
  - e. Turn on gas supply line.

## Adjusting Pilot Pressure

---

1. Remove pilot adjustment cap with Philips screwdriver.

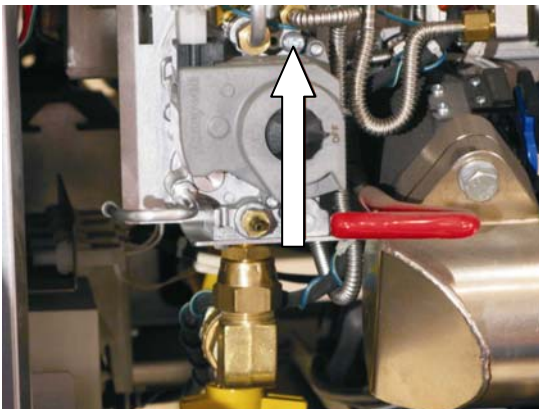

2. Rotate adjuster clockwise to decrease and counter-clockwise to increase pilot flame.
3. Replace adjustment cap.

## Calibrating Solid State Thermostat

---

1. Remove the cap of the knob with a flat head screwdriver.



2. With a 5/16 inch socket, loosen the collet.
3. Rotate the knob to point at actual temperature.
4. Tighten collet and replace knob cap.

## Replacing the Controllers and Wiring Harness

---

### Removing the Controller Front Panel Bezel

---

1. Remove the two (2) screws on the controller panel using a Phillips screwdriver.



2. Pull out the controller panel front bezel.



3. Disconnect the controller wiring harness.

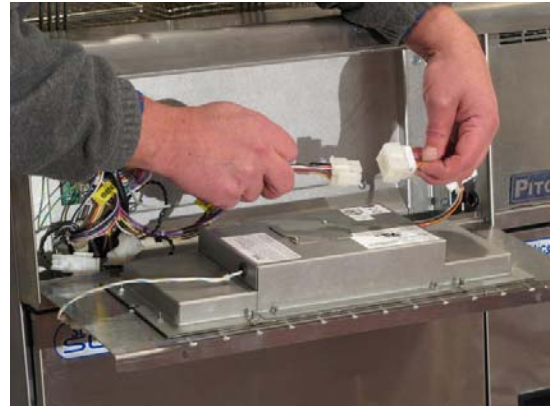

4. Remove the four (4) screws on the back side of the bezel using a 3/8 inch nut driver.

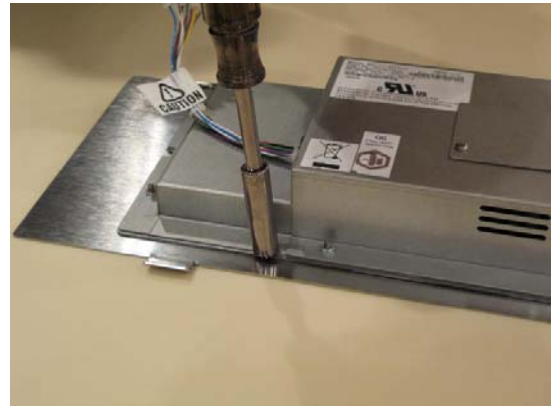

## Removing the Solid State Wiring Harness

---

1. Remove the two (2) screws in the front panel bottom holder using a 5/16 inch socket.

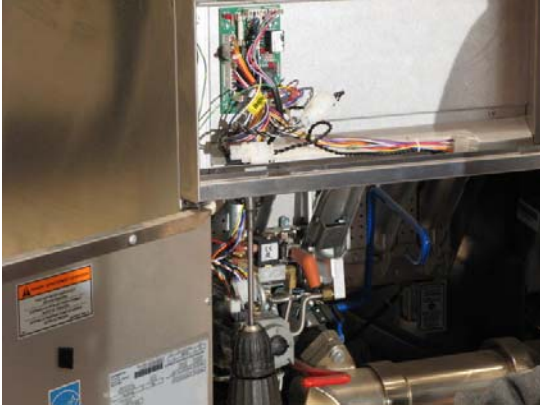

2. Remove the two (2) screws in the cable retainer bracket using a 5/16 inch socket.



3. Disconnect the probe connection (J/P43).

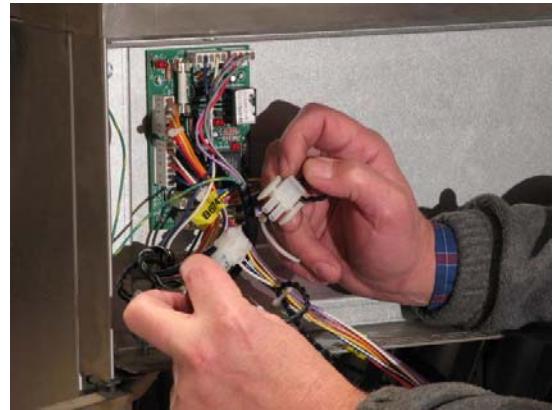
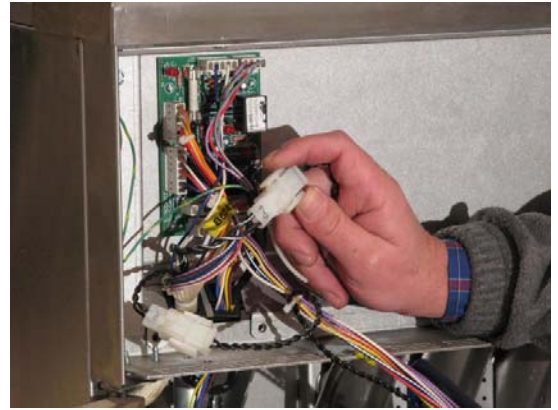

4. Disconnect B6746601 from J/P33 on the relay board.

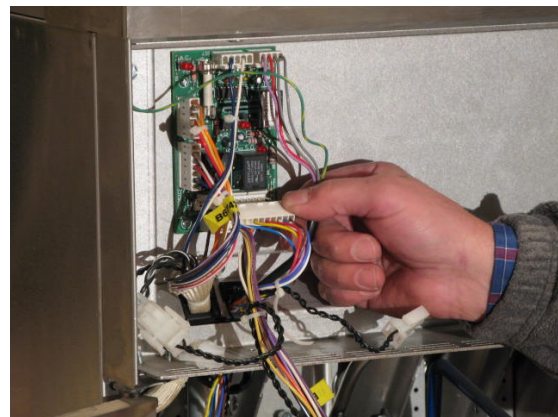

5. Loosen the controller box screws using a 5/16 inch socket.

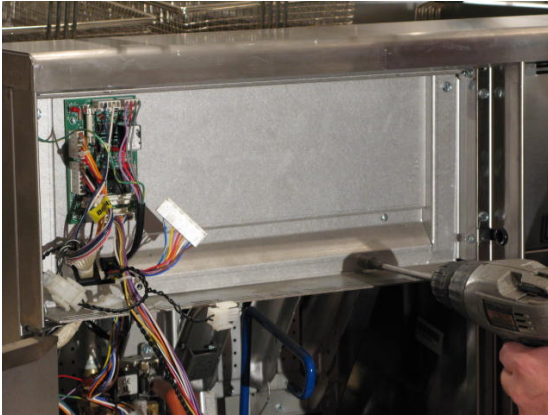

6. Remove the controller wiring harness.

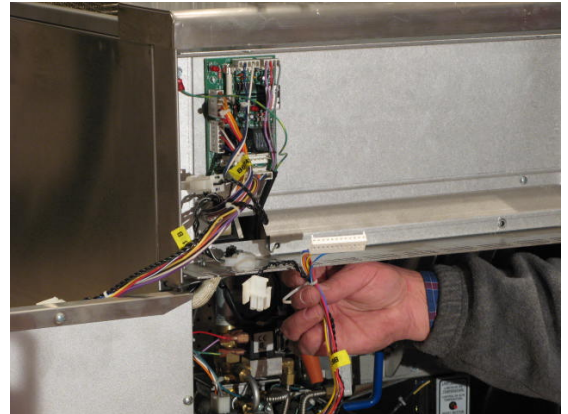

7. Replace with a new controller wiring harness following steps 1 through 6 in reverse.

## Replacing the Relay Board and Paper

---

1. Remove the front panel. See “Removing the Controller Front Panel Bezel” on page 20.
2. Disconnect all connections.

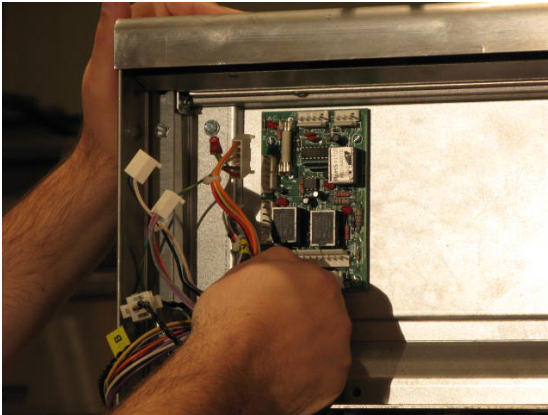

3. Remove the four (4) screws, which hold down the relay board, using a small flathead screwdriver.

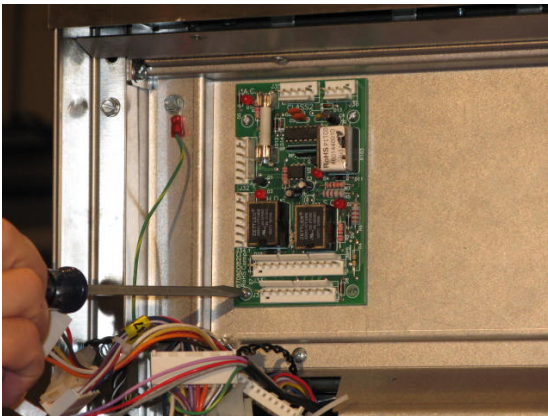

4. Remove the relay board and flip it over.

5. Remove the existing insulator and replace with a new insulator.

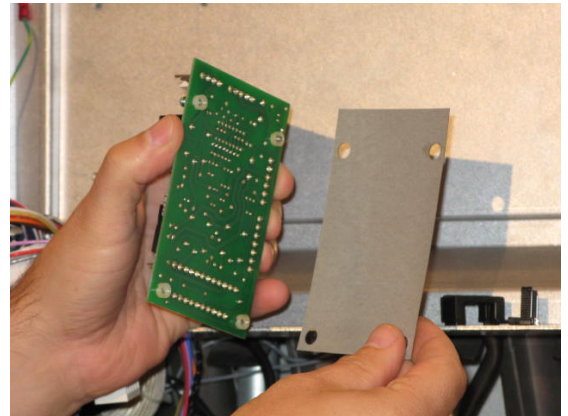

**NOTE:** Make sure the insulator does not have puncture marks in it.

6. Reconnect all connections and reinstall the front panel.

## Replacing the Ignition Module

1. Remove one (1) screw, which hold the ignition module, using a 5/16 inch socket.



2. Pull the module box and bracket toward the front of the unit, and then to the right.

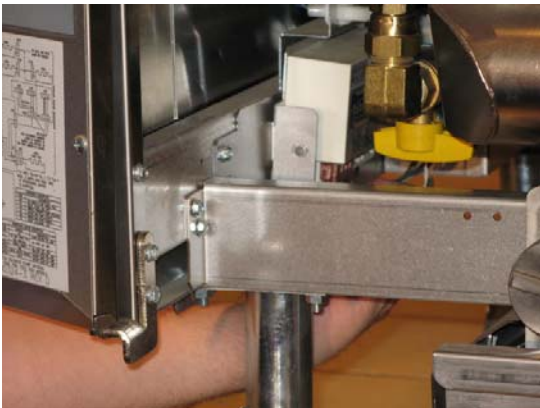

3. Disconnect the plug.

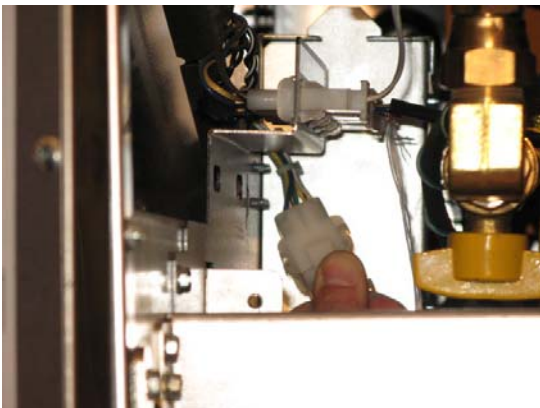

4. Remove the ignition wire.

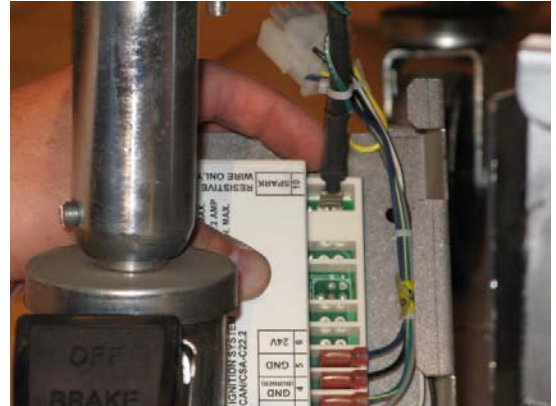

5. Remove the two (2) screws, which hold the module on the plate, using a Phillips screwdriver.



6. Remove the harness pins using needle-nose pliers.



7. Follow steps 1 through 6 in reverse.

## Replacing the Spinal Tap

---

1. Remove the two (2) screws in the front of the unit, which hold the entrance box assembly, using a 5/16 inch socket.



2. Cut the zip ties from the cord retainers.

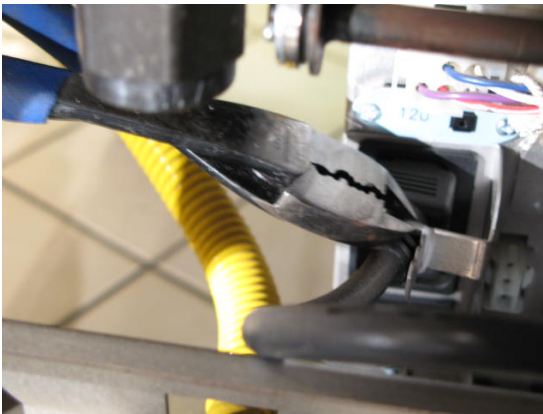

3. Unplug the cords from the electrical entrance box assembly.



4. Remove the two (2) screws, which hold the spinal harness, using a 1/16 socket.



5. Remove the entrance box assembly.



6. Remove the front panel assembly. See “Replacing the Controllers and Wiring Harness” on page 20.

7. Disconnect all the connections and remove the harness from front panel.

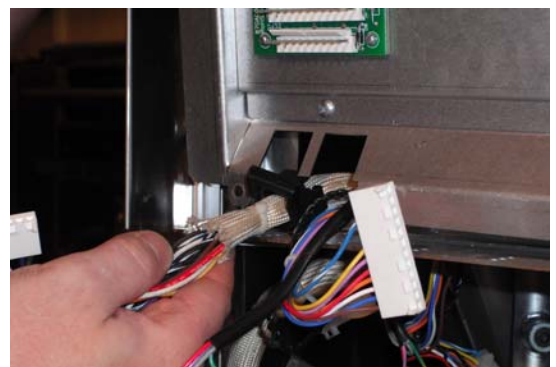

8. Disconnect the connection from the valve.



9. Remove the bolt from the pilot, which holds the ignition ground, using a 5/16 inch open-ended wrench.

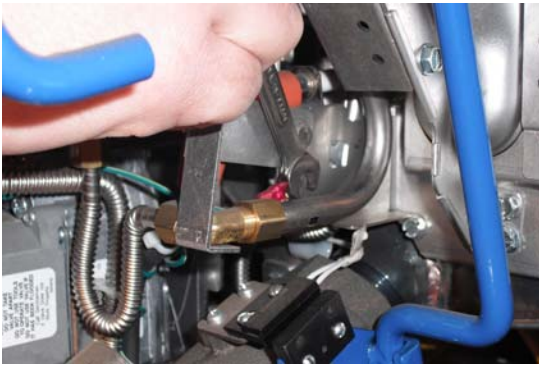

10. Once the entrance box is out, disconnect the spinal tap connection.



11. Remove one (1) screw using a 5/16 inch socket.

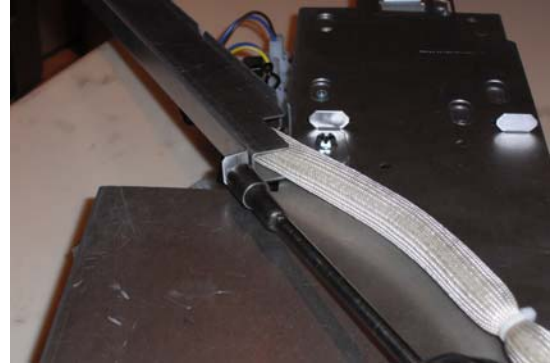

12. Slide metal retaining bracket off.

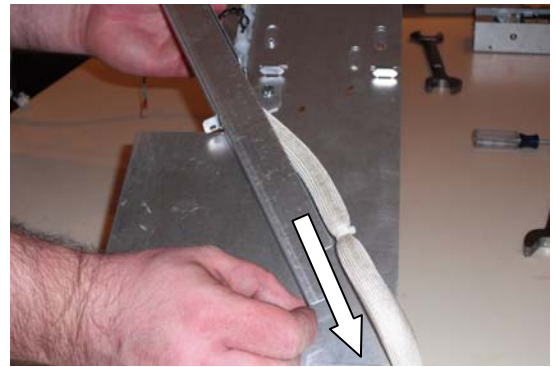

13. Remove the spinal tap wiring harness from the grommet.

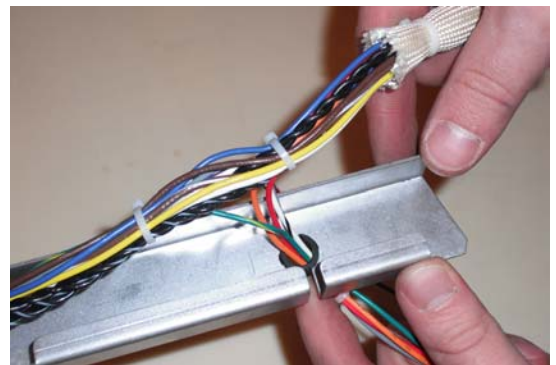

14. Disconnect J4, J5, J7, J8 plugs using needle-nose pliers.

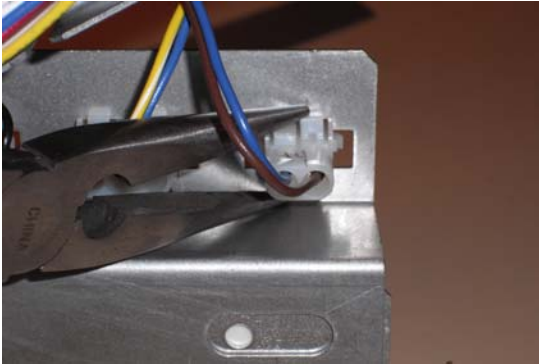

15. Make sure to connect the new plugs into the correct connector location.

#### Side View of Plugs

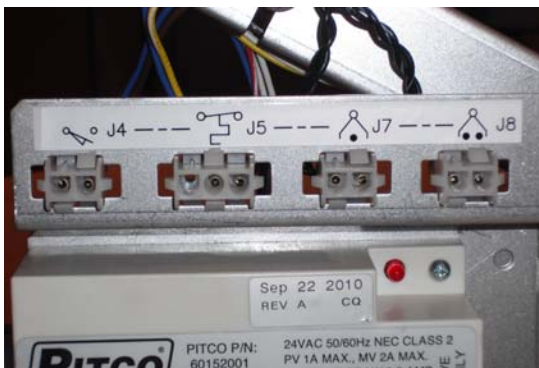

#### Top View of Plugs

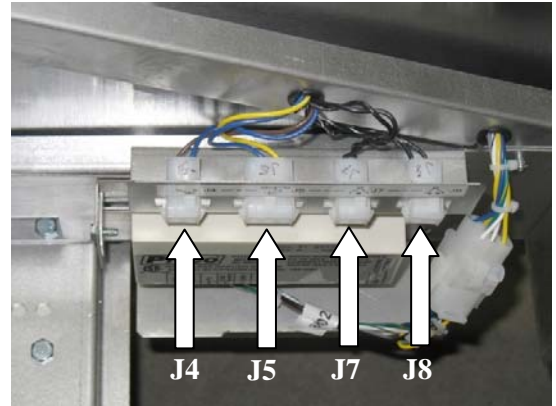

16. Follow steps 1 through 15 in reverse to reinstall the entrance box and new spinal tap wiring harness.

## Replacing an Igniter/Pilot Assembly

---

1. Remove the two (2) screws, which hold the pilot and runner tube orifice bracket, using a 5/16 inch socket.



2. Remove the two (2) screws, which hold the runner tube, using a 5/16 inch socket.



3. Remove the runner tube orifice using a 1/2 inch open-ended wrench.

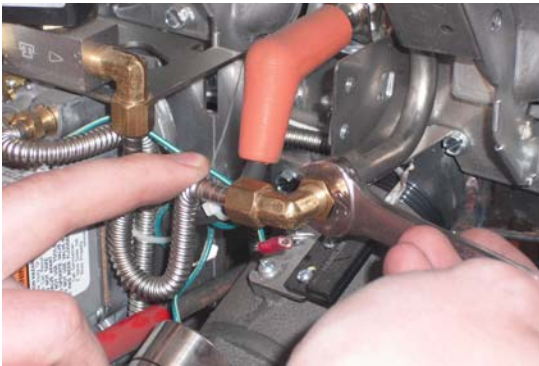

4. Remove the two (2) screws, which hold the pilot, using a 5/16 inch socket.

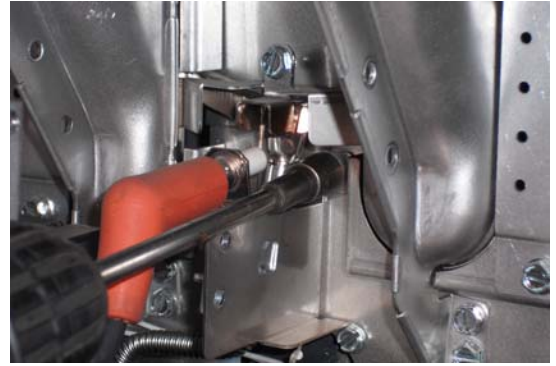

5. Remove the ignition wire.

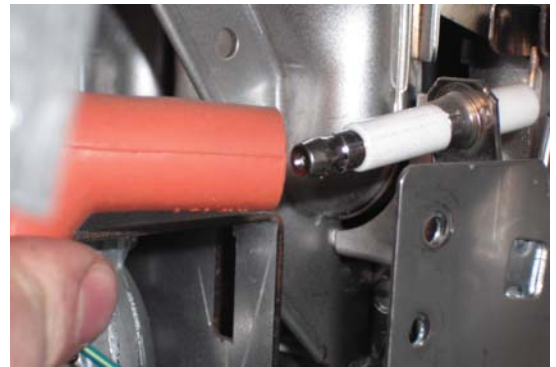

6. Cut the zip ties, which hold the ignition wire to the pilot tubing.



7. Remove the flexible line for the pilot tubing at the gas valve using a 1/2 inch open-ended wrench.

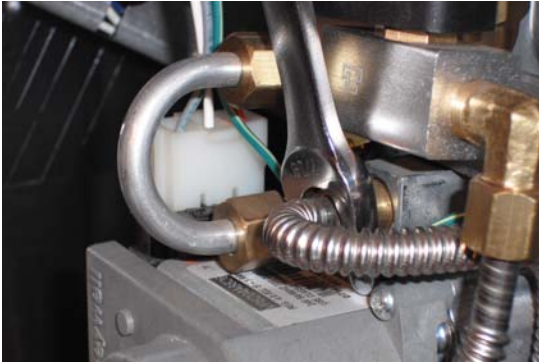

8. Remove the two (2) screws at the bottom of the left and right burner using a 5/16 inch socket.



9. Remove one (1) screw, which holds the flame jumper shield, using a 5/16 inch socket.

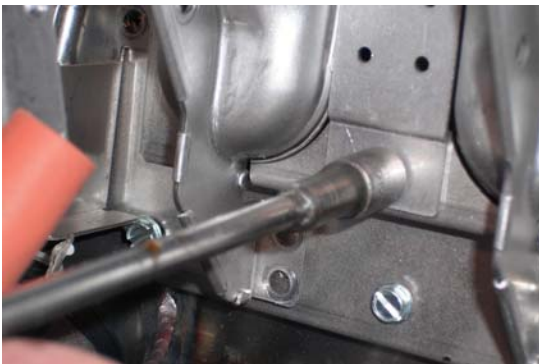

10. Remove the burner.

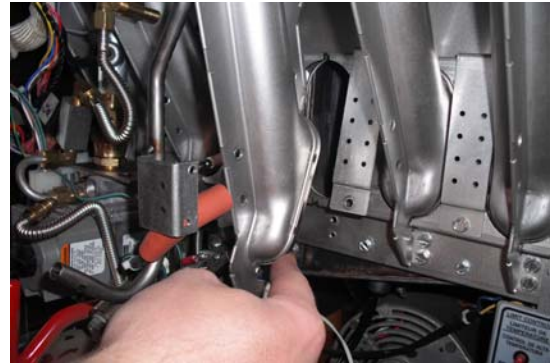

11. Remove the pilot assembly.



12. Remove the nut, which holds the pilot tubing, using a 1/2 inch open-ended wrench.



13. Follow steps 1 through 12 in reverse to reinstall new pilot assembly.

## Replacing the Self-Cleaning Burner Solenoid

---

1. Remove the SCB flex tube fitting using a 1/2 inch open-ended wrench.

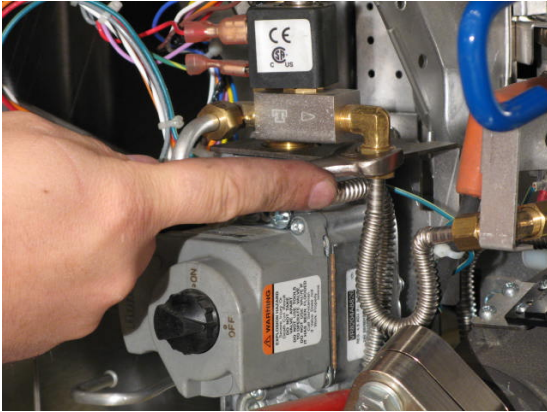

2. Remove the SCB valve inlet fitting using a 1/2 inch open-ended wrench.

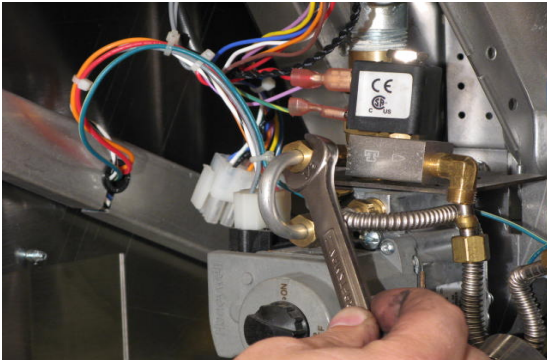

3. Disconnect the terminals using needle-nose pliers.

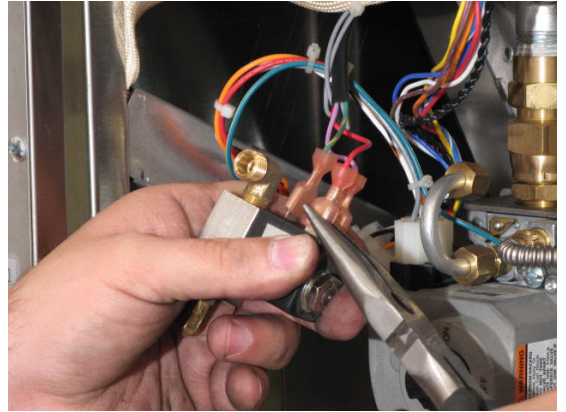

4. Remove the two (2) elbows using a 1/2 inch open-ended wrench.



5. Follow steps 1 through 4 in reverse to reinstall SCB valve.

## Replacing the Gas Valve

---

1. Remove the pilot tubing from the gas valve using a 7/16 inch open-ended wrench.

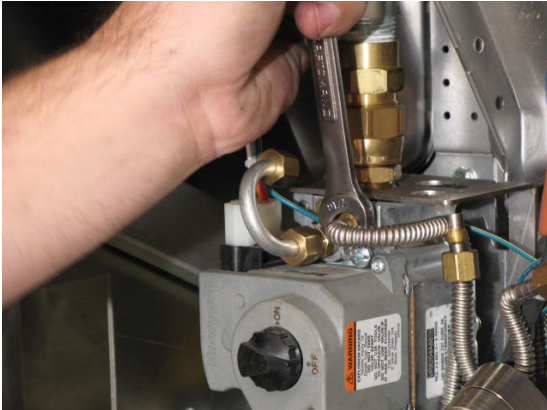

2. Disconnect the wiring connection from gas valve.



**NOTE:** On mV unit, use a Phillips screwdriver to remove screws on the wiring connection (not shown).

3. Holding the elbow with a wrench, remove the swivel nut on the bottom gas valve fitting using a 1-1/16 inch open-ended wrench.



4. Holding the elbow with a wrench, remove the swivel nut on the top gas valve fitting using a 15/16 inch open-ended wrench.



5. Remove the gas valve.

6. Remove the fittings and plate from the gas valve using a 7/16 inch open-ended wrench.

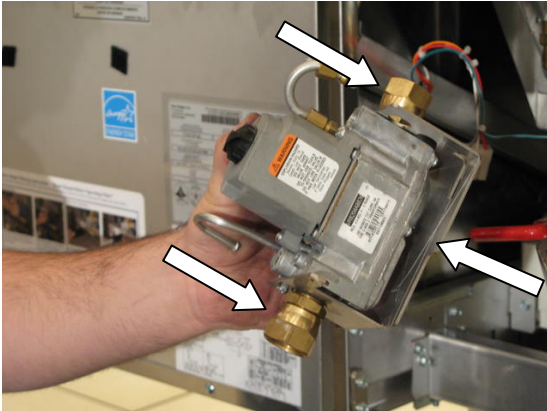

7. Install the heat shield, vent tube, and fittings.
8. Reinstall a new gas valve by following steps 1 through 6 in reverse.

## Replacing the Transformer Box

---

1. Cut the zip ties on the transformer box power supply cords.

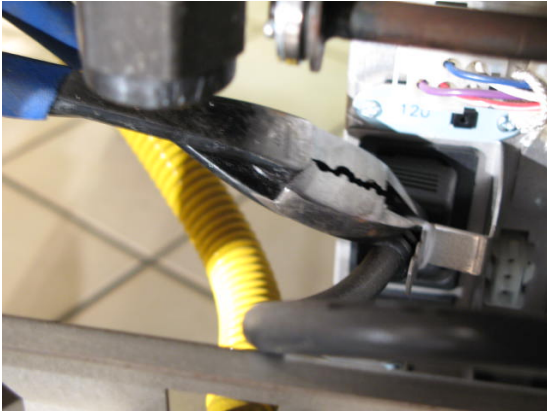

2. Remove transformer box power supply cords.



3. Disconnect the spinal tap wiring harness from the transformer box.

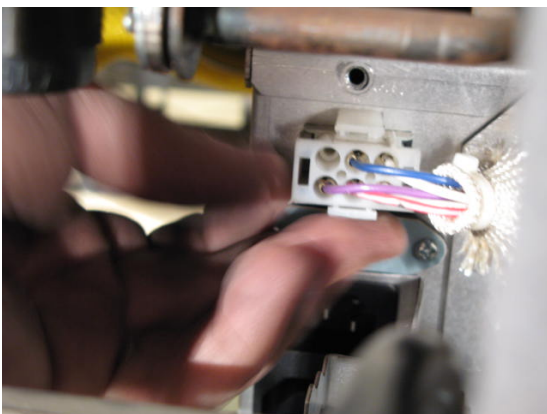

4. Remove the two (2) screws, which hold the transformer box, using a 5/16 inch socket.

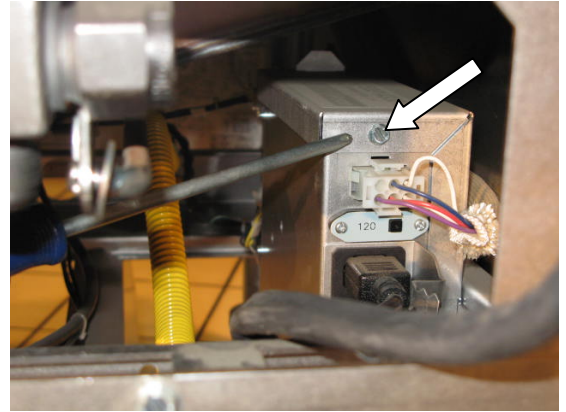

5. Remove the transformer box by pushing the box towards the front of the unit.

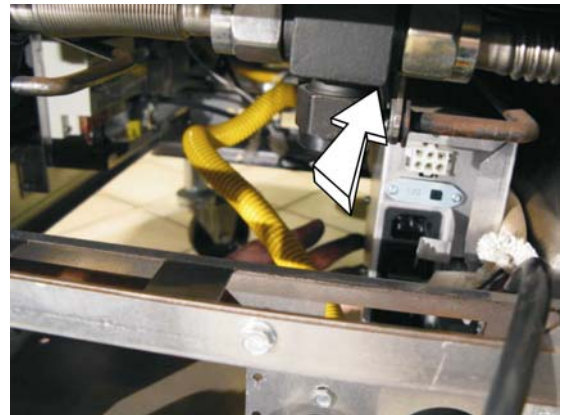

6. Lower the transformer box to the floor and then pull out.



7. Remove all the wires on transformer box using needle-nose pliers. See “Simplified Wiring Diagrams” starting on page 89.

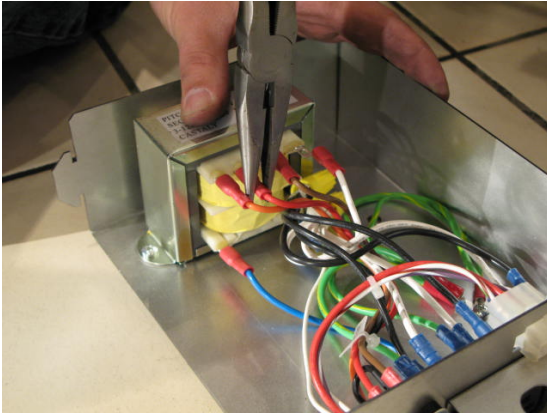

8. Remove the two (2) screws, which hold the transformer, using a Phillips screwdriver.

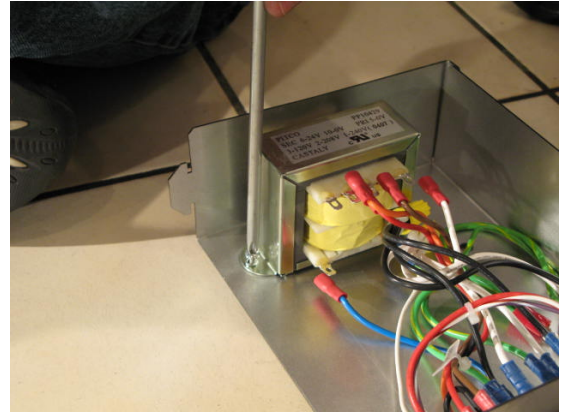

9. Remove the transformer.
10. Follow steps 1 through 8 in reverse to reinstall a new transformer.

## Replacing the DVI Switch

---

1. Remove the two (2) screws, which hold the proximity sensor on the drain handle, using a flathead screwdriver.

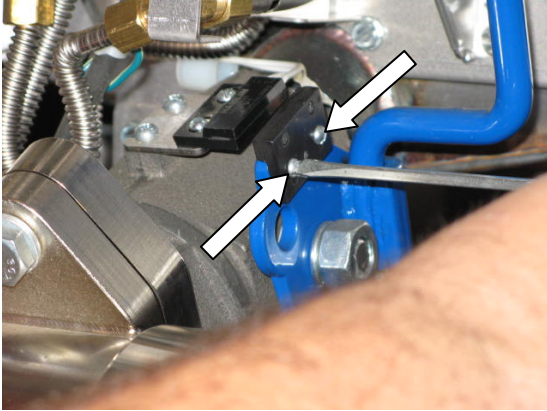

2. Remove the two (2) screws, which hold the actuator, using a flathead screwdriver.

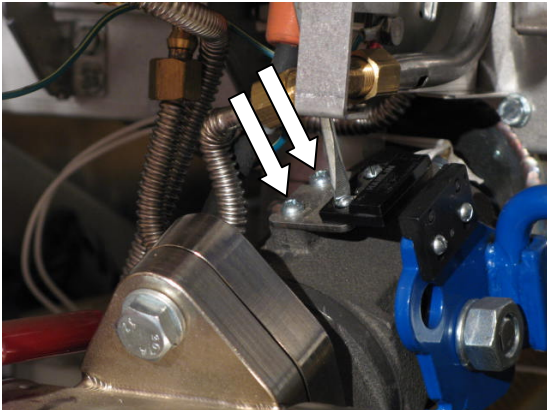

3. Replace the DVI switch ensuring a 1/4 inch gap between the actuator and the magnet.
4. Follow steps 1 through 3 in reverse to reinstall a new DVI.

## Replacing the Burner Assembly

### Replacing the Burner(s)

1. Drop the gas valve out of the way by holding the elbow with a wrench and removing the swivel nut on the top gas valve fitting using a 15/16 inch open-ended wrench.

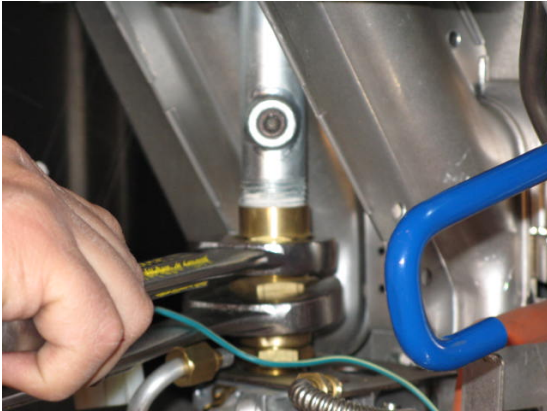

2. Remove the nut, which holds the drain valve handle, using an 11/16 inch socket.

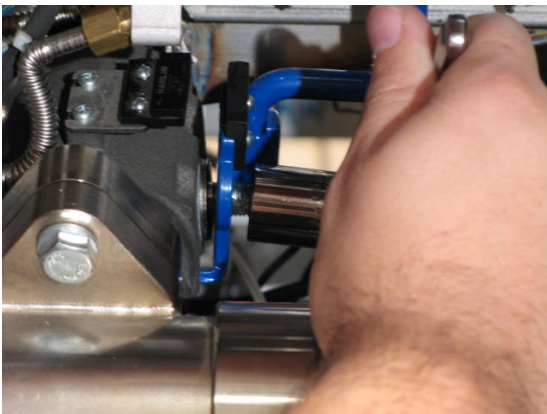

**NOTE:** Hold the drain valve handle when removing the nut to ensure that the oil does not drain out.

3. Remove the drain valve handle by sliding handle off the stem.

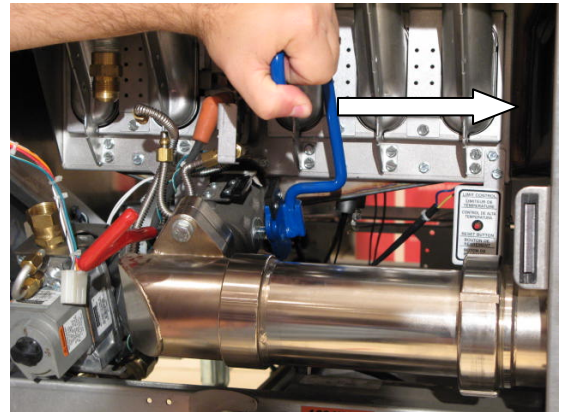

4. Remove the pilot assembly. See “Replacing an Igniter/Pilot Assembly” on page 28.
5. Remove the two (2) screws, which hold the rollout switch, using a 5/16 inch socket.

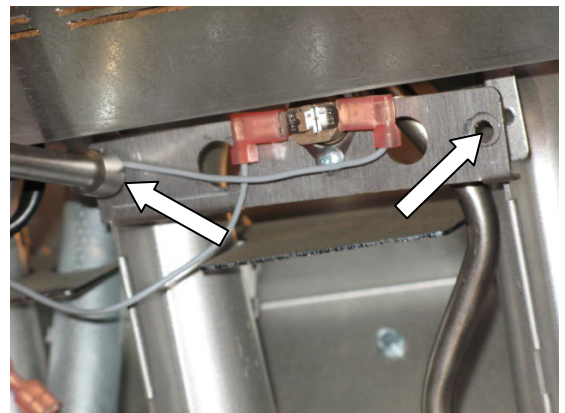

6. Remove the screws, which hold the flame jumper shields, using a 5/16 inch socket.

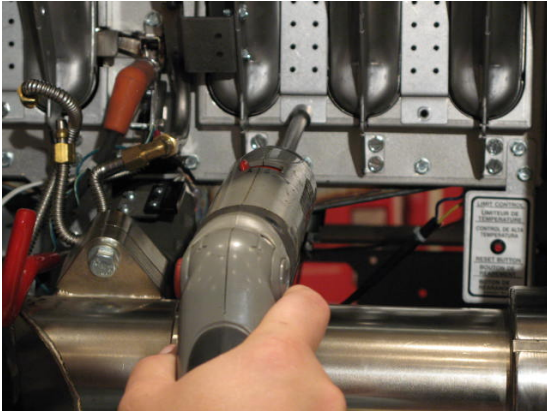

7. Remove the flame jumper shields on both sides of the burner.

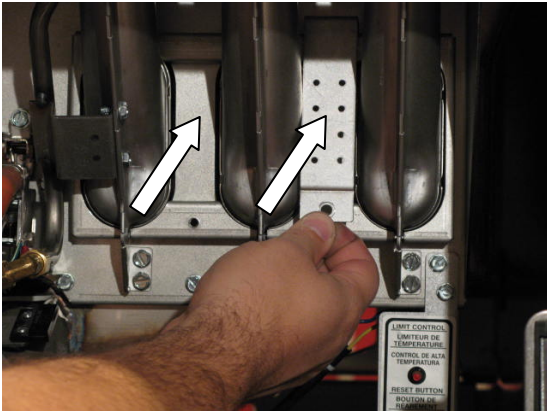

8. Remove the two (2) screws, which hold the SCB runner tube, using a 5/16 inch socket.
9. Remove the two (2) screws, which hold each burner, using a 5/16 inch socket.

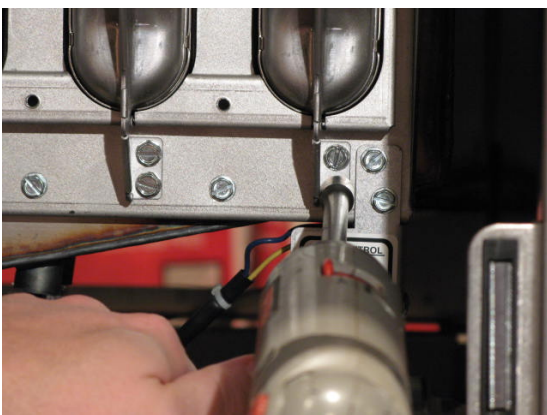

10. Remove the right burner(s) by sliding them off the SCB runner tube.

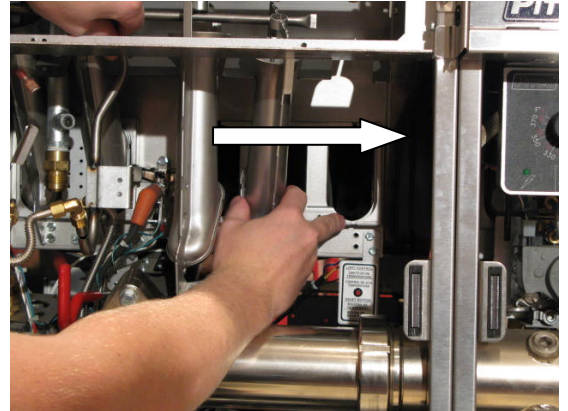

11. Remove the SCB runner tube.

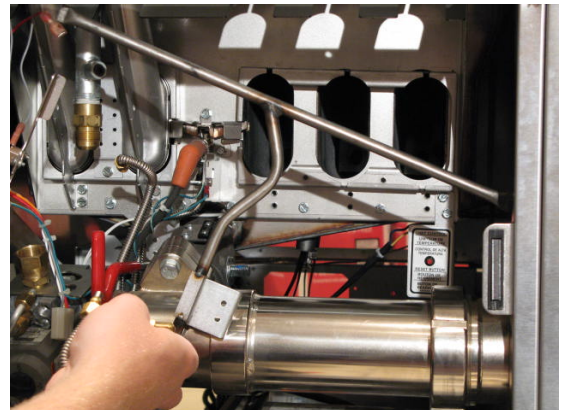

12. Remove the left burner(s) by sliding them off the SCB runner tube.
13. Reinstall the new burner(s) by following steps 1 through 12 in reverse.

## Replacing the Burner Assembly

1. See “Replacing the Burner(s)” on page 36.
2. Remove the burner shield.

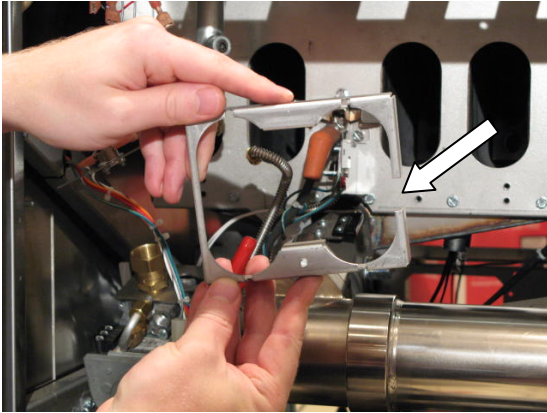

**NOTE:** When reinstalling, the burner shield opening should face toward the pilot.

3. Remove the two (2) screws, which hold the pilot assembly, using a 5/16 inch socket.



4. Remove the two (2) screws, which hold the high-limit bracket, using a 5/16 inch socket.



5. Remove the ten (10) screws (5 screws on the top and 5 screws on the bottom), which hold the burner rack, using a 5/16 inch socket.

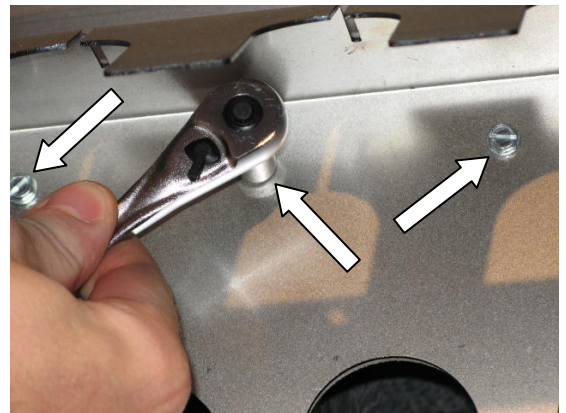

6. Remove the two (2) screws, which hold the drain lock switch, using a flathead screwdriver.

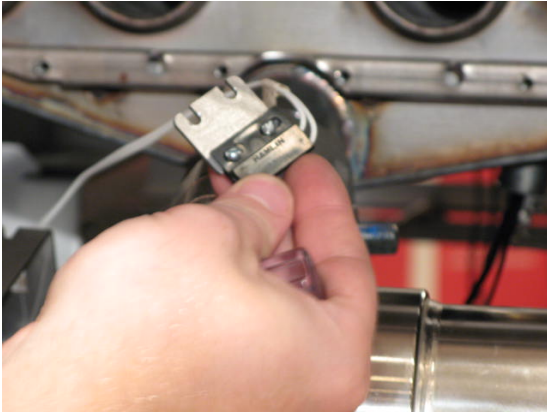

7. Remove the burner rack by pulling it toward the front of the unit.

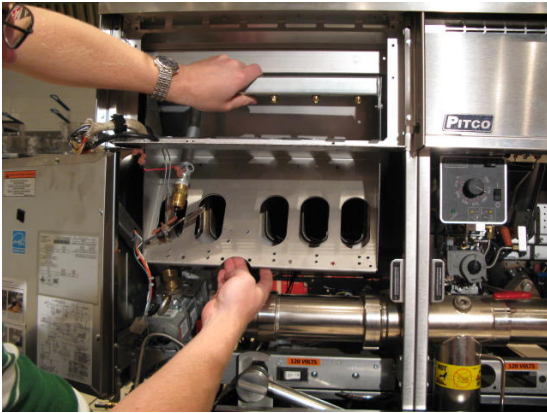

8. If necessary, replace the insulation on the back of the burner rack.

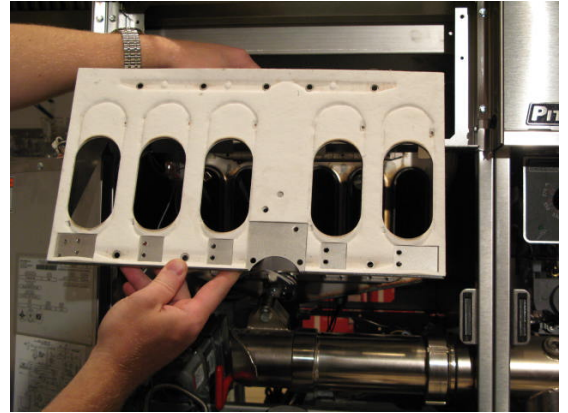

9. Reinstall a new burner assembly by following steps 1 through 7 in reverse.

## Replacing the Frypot

1. Remove the controller front panel, gas valve, pilot assembly, and burner assembly.
2. Remove the baffle by pulling it out.

**NOTE: For SSH models only.**

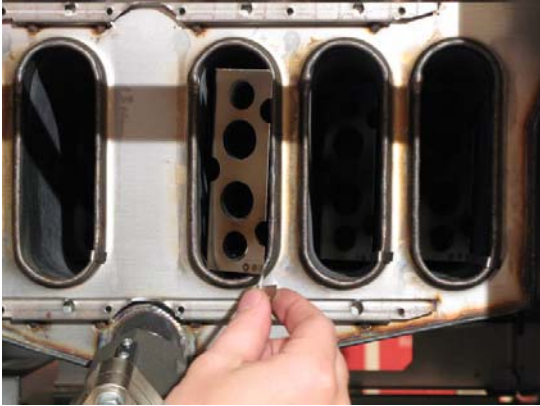

3. Remove the drain manifold flange nut using a 9/16 inch close-ended wrench.



4. Loosen the collet using a spanner wrench.



5. Remove the collet.

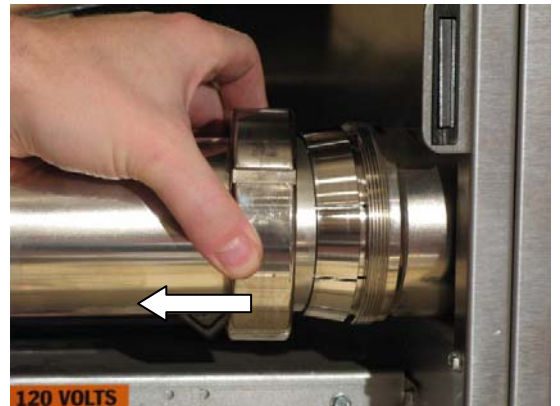

6. Slide piping away from flange.

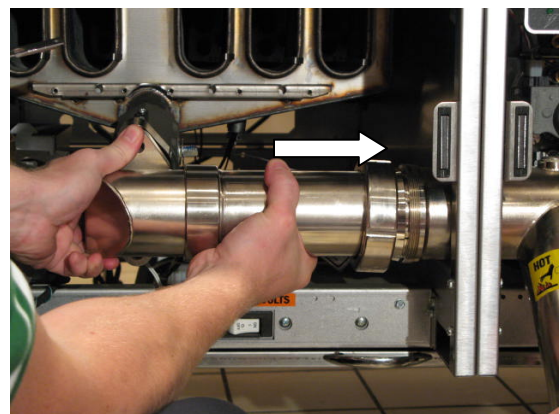

7. Remove the flange elbow.



8. Remove the control box and wiring harness for each fryer that shares a common top deck.
9. Remove the four (4) screws per fryer, which hold the top deck down, using a 5/16 inch socket.



10. Remove the top deck by pulling up.



11. Remove the six (6) screws, which hold the back of the splash back, using a 5/16 inch socket.



12. Score the silicon sealer between the front of the splash backs using a flathead screwdriver or utility knife.



13. Remove the two (2) screws, which hold the front of the splash back, using a flathead screwdriver.



14. Remove the splash back by lifting up.



15. Remove the six (6) screws, which hold the tank to the cabinet, using a 5/16 inch socket.

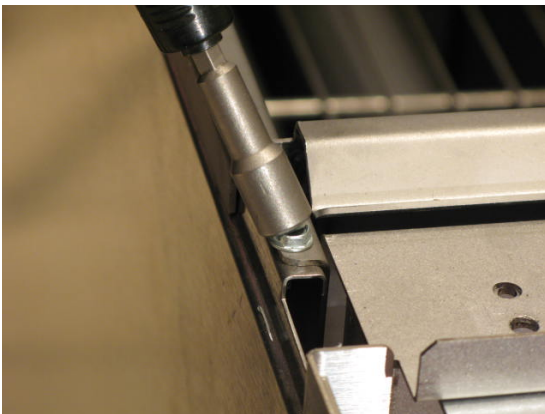

16. Remove the channel strip by pulling up.



17. Score the silicon sealer between the tanks using a flathead screwdriver or utility knife.



18. Remove high-limit and temperature probes. See "Replacing the Hi-Limit Thermostat" on page 58.

19. Remove the two (2) screws, which hold the top deck support, using a 5/16 inch socket.

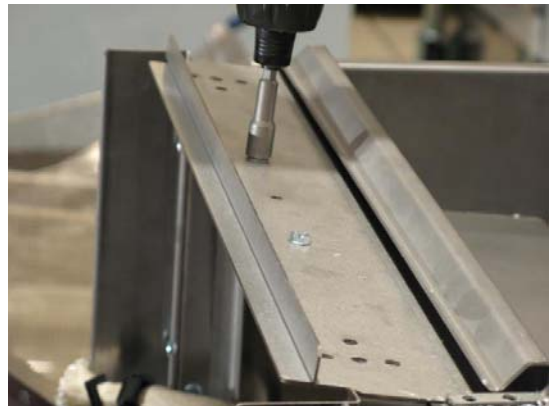

20. Lift up and pull out the tank.



**NOTE:** Lifting the tank requires two (2) technicians.

21. Set tank on floor.

22. Remove the drain line using a pipe wrench.



23. Remove the four (4) screws, which hold the flue, using a 5/16 inch socket and 3/8 inch close-ended wrench.



24. Remove the return valve using two adjustable wrenches.



25. Follow steps 1 through 24 in reverse to reinstall a new frypot.

## Replacing the Basket Lift Components

---

### Removing the Basket Lift Cover

---

1. Remove the six (6) screws, which hold the back of the basket lift cover, using a 5/16 inch socket.
2. Lift up the back and remove.

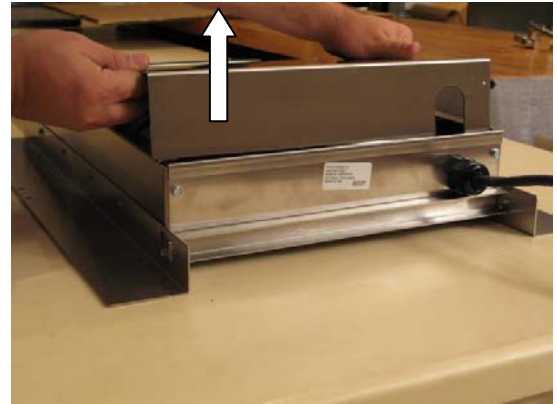
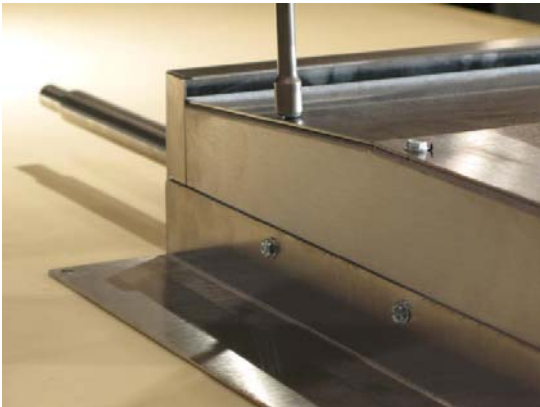

### Replacing the Transformer

---

1. Remove the two (2) screws, which hold the transformer, using a 5/16 inch socket.
2. Remove all wires on transformer box using needle-nose pliers. See “Wiring Diagram – Basket Lifts” on page 91.

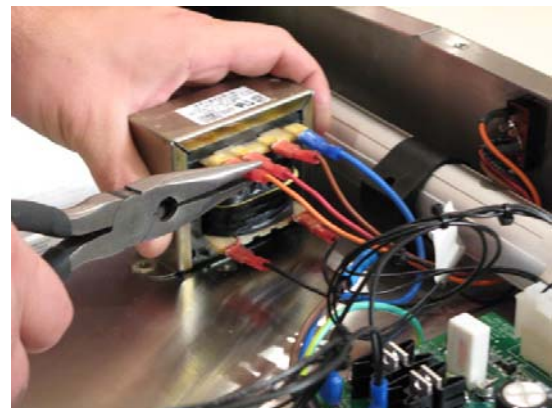

3. Follow steps 1 through 2 in reverse to reinstall new transformer box.

## Replacing the Basket Lift Driver Board

1. Remove all wires on basket lift driver board using needle-nose pliers.

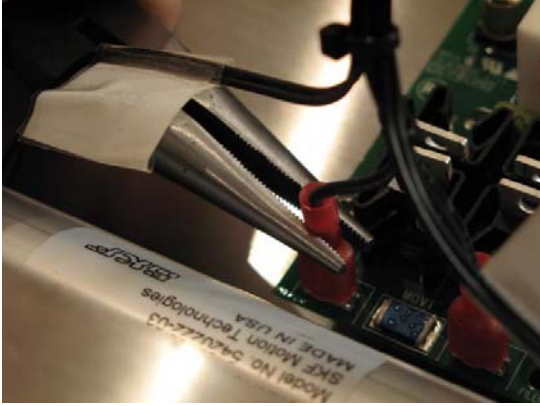

2. Remove the sensor connection using needle-nose pliers.

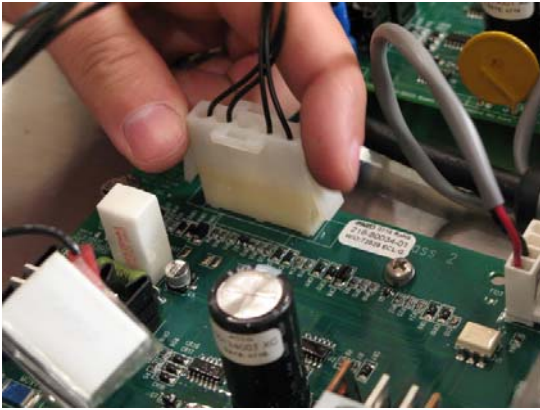

3. Remove the control signal connection using needle-nose pliers.

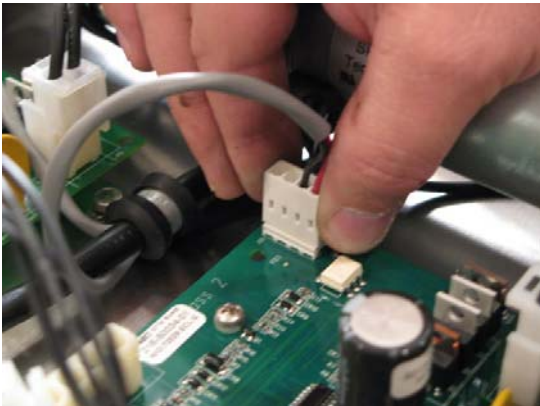

4. Remove the actuator power connection using needle-nose pliers.



5. Remove the four (4) screws, which hold the basket lift driver board, using a Phillips screwdriver.

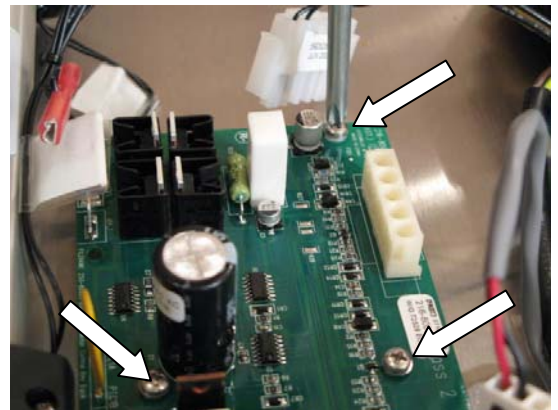

6. Follow steps 1 through 5 in reverse to reinstall a new basket lift driver board.

## Adjusting the Magnetic Sensor

1. Make sure the sensor is approximately 3/4 inch from top of the motor to bottom of the sensor.
2. Make sure the sensor is approximately 7 3/4 inch from top of the motor to bottom of the sensor.

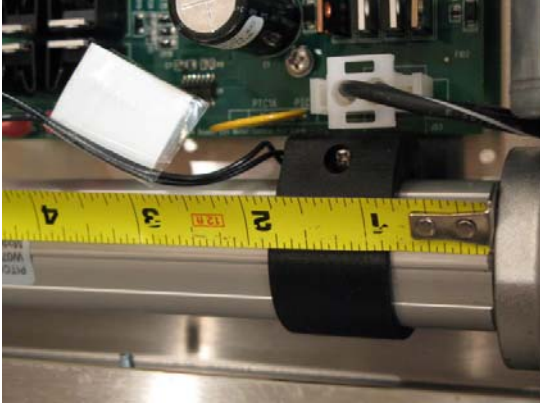

## Replacing the Basket Lift Actuator

1. Cut all zip ties on the basket lift driver board.
2. Disconnect the transformer from the driver board. See “Wiring Diagram – Basket Lifts” on page 91.

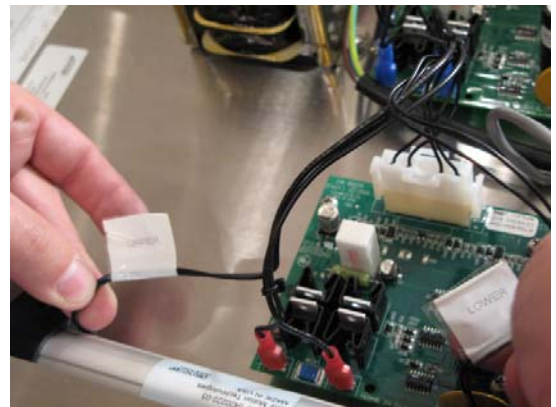

3. Disconnect the upper and lower limit connections on the basket lift driver board.

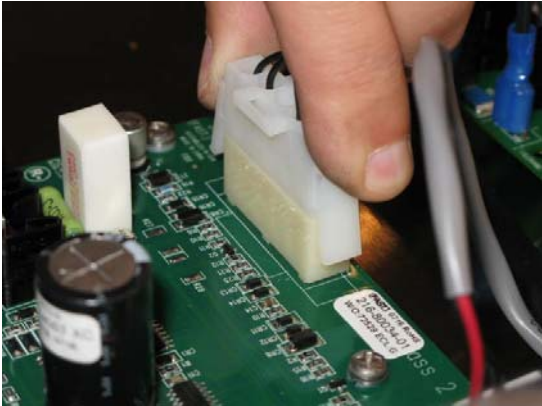

4. Remove the two (2) bolts, which hold the actuator, using a 3/16 inch Allen key.

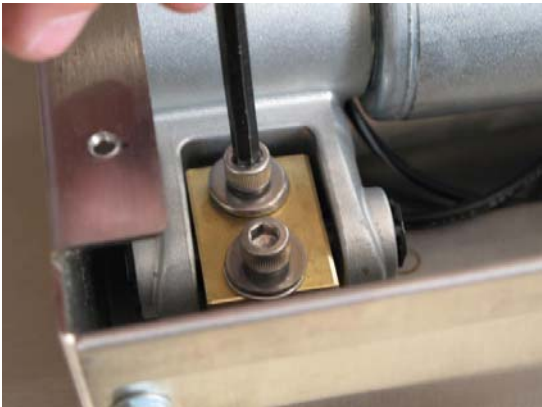

5. Remove the top retaining bushing by unscrewing.



6. Slide the bushing off the shaft.



7. Disconnect the motor connector from the driver board.

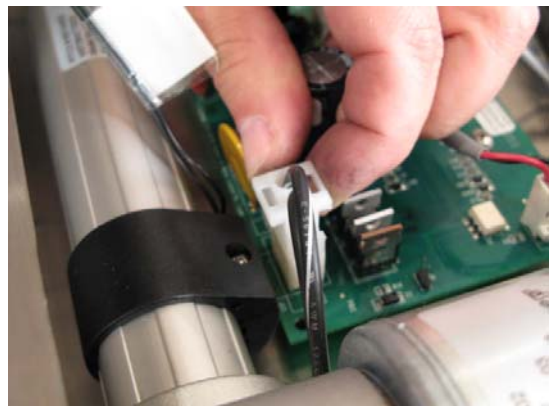

8. Rotate up the actuator collar.



9. Remove the actuator collar.



10. Follow steps 1 through 9 in reverse to reinstall a new basket lift actuator.

## Gas Conversion

1. Remove the pilot assembly. See “Replacing an Igniter/Pilot Assembly” on page 28.
2. Remove the nut, which holds the pilot tube, using a 1/2 inch open-ended wrench.
3. Replace bullet orifice with one provide in the gas conversion kit.
4. Change the main burner orifice tips.

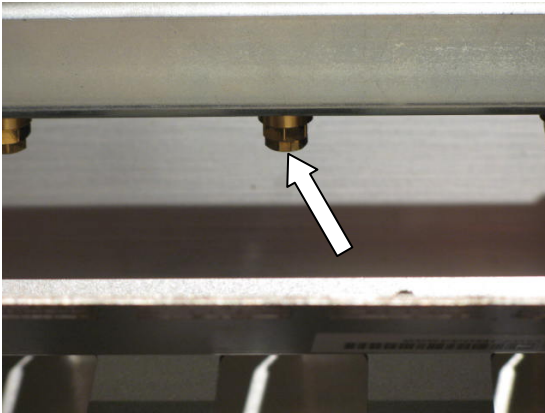

5. Change the SCB orifice tip.

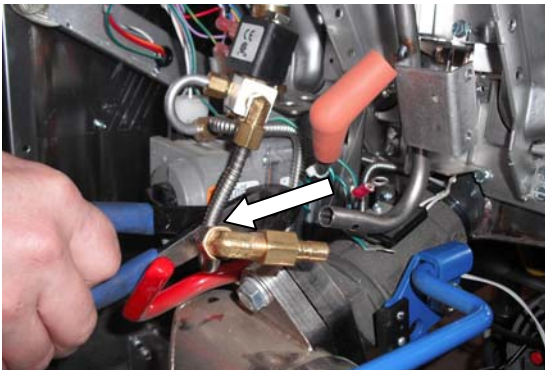

6. Replace and adjust the gas valve regulator.

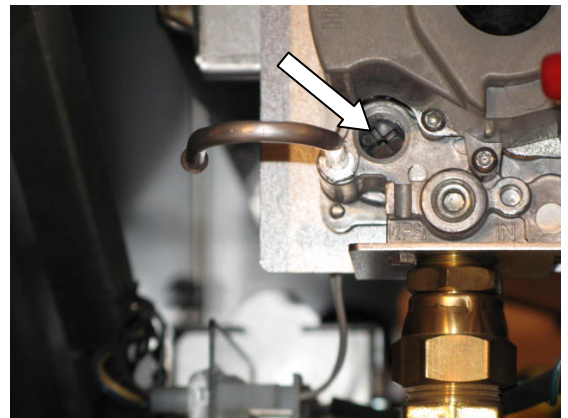
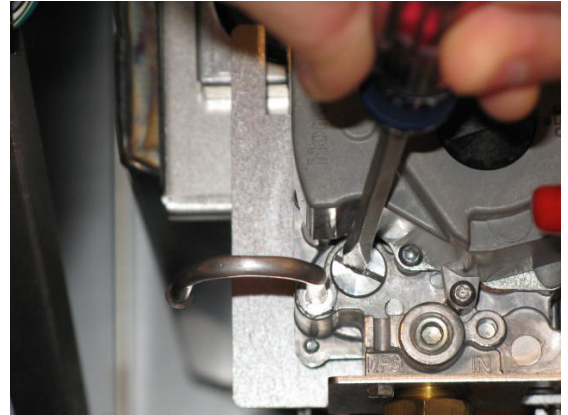

7. Adjust the burner manifold pressure.

### Manifold Gas Pressure Table

| NAT  | LP  |
|------|-----|
| 4.0" | 10" |

- a. Insert a flathead screwdriver into the cap and turn counter-clockwise to remove it.
  - b. Insert flathead screwdriver into the cap and turn counter-clockwise to increase the gas pressure or clockwise to decrease the gas pressure.
8. Put a sticker on the door saying the unit has been converted.

# mV Model

## Accessing Fryer for Servicing

---

1. Shut off the main gas supply line.

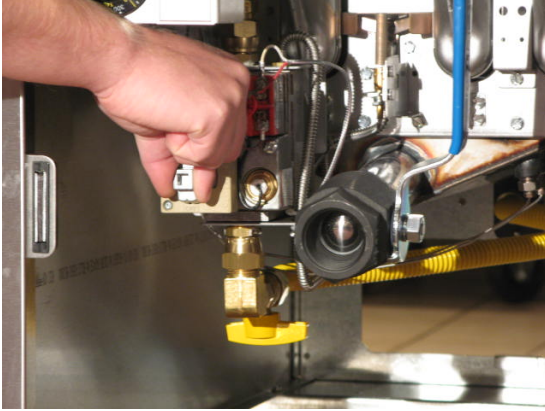

2. Shut off the individual gas supply line.



## Cleaning the Gas Valve Vent Tube

---

See “Cleaning the Gas Valve Vent Tube” on page 13.

## Checking the Burner Manifold Gas Pressure

---

### Taking an Incoming Supply Gas Pressure Reading

---

1. Unscrew and remove the gas supply plug with a 3/16 inch hex wrench.
3. Finish tightening the test fitting using a 7/16 inch open-ended wrench.
4. Connect the manometer.

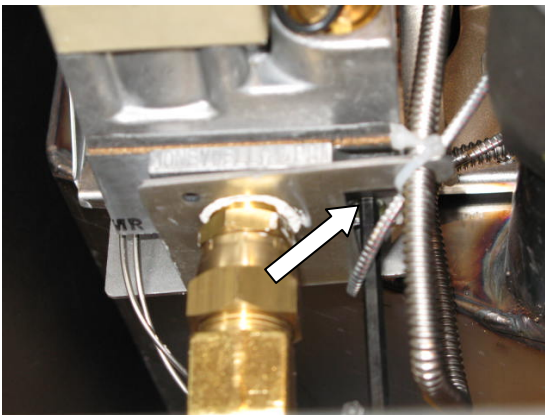

2. Finger tighten the test fitting into the test port.

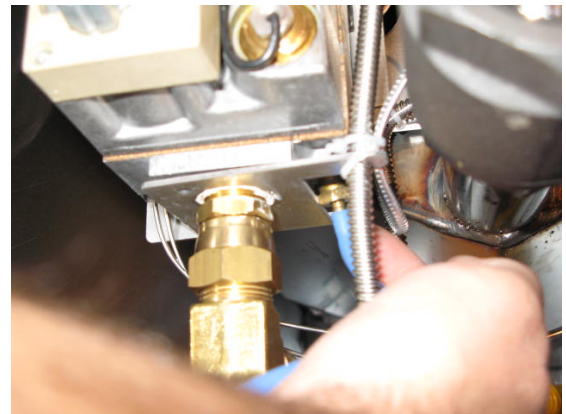

5. Turn on the main gas supply line.

6. Check the supply gas pressure with the manometer and compare the reading to the Supply Gas Pressure table on page 52 to determine what the incoming gas pressure should be.

### Supply Pressure Table

| NAT    | LP       |
|--------|----------|
| 7 to 9 | 11 to 13 |

**NOTE:** You cannot adjust the supply gas pressure at the unit. Anything over/under the recommended amount should be adjusted at the facility's main gas line.

7. When adjustment is complete:
  - a. Shut off the main gas supply line
  - b. Disconnect manometer.
  - c. Remove the test fitting.
  - d. Apply Fluoropolymer paste to gas supply plug.
  - e. Reinstall gas supply plug with a 3/16 inch hex wrench.
  - f. Turn on the main gas supply line.

## Taking a Manifold Gas Pressure Reading

1. Unscrew and remove the gas manifold plug with a 3/16 inch hex wrench.
3. Finish tightening the test fitting using a 7/16 inch open-ended wrench.



2. Finger tighten the test fitting into the test port
4. Connect the manometer.



## Adjusting Manifold Gas Pressure

1. Check the manifold gas pressure with the manometer and compare the reading to the Manifold Gas Pressure table.

**Manifold Gas Pressure Table**

| NAT  | LP  |
|------|-----|
| 4.0" | 10" |

2. Insert a flathead screwdriver into the cap and turn counter-clockwise to remove it.



3. Insert flathead screwdriver into cap and turn counter-clockwise to increase the gas pressure or clockwise to decrease the gas pressure.

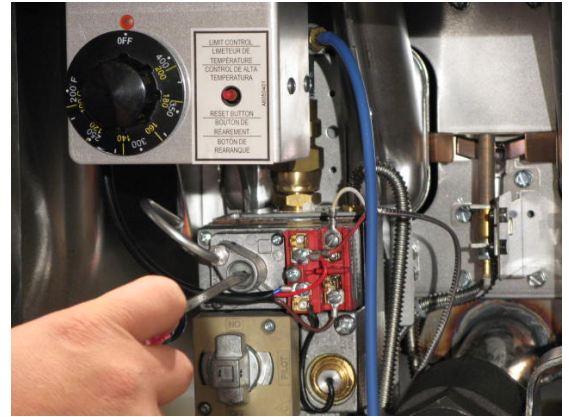

4. When adjustment is complete:
  - a. Shut off the gas supply line.
  - b. Disconnect manometer.
  - c. Remove the test fitting.
  - d. Reinstall the gas manifold plug.
  - e. Turn on gas supply line.

# Measuring Thermopile

## Taking a Millivolt Reading

1. Make sure the multimeter is set to mV.



2. Touch the thermopile leads with the multimeter probes as shown.

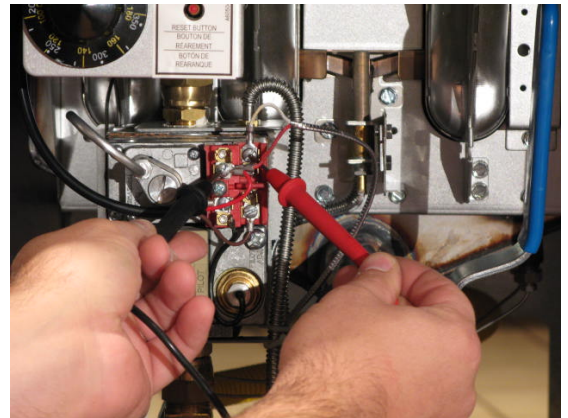

## Adjusting the Thermopile

1. Compare the multimeter reading to the Thermopile mV table.

**Thermopile mV Table**

| Pilot lit             | Pilot lit with burners on                                |
|-----------------------|--|
| PP1 to PP2<br>600± mV | PP2 to TH2 approximately<br>300 mV less than pilot alone |

2. Insert a flathead screwdriver into the Pilot Adj. cap and turn counter-clockwise to remove it.

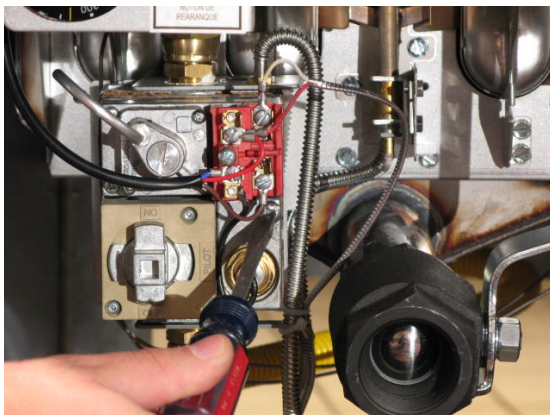

**mV Gas Valve Resistance Readings Table**

| Pilot Valve         | Main Valve         |
|---------------------|--------------------|
| TH 1 to PP 2 10.4 Ω | TH 2 to PP 2 2.0 Ω |

3. Insert flathead screwdriver into Pilot Adj. screw and turn counter-clockwise to increase the mV pressure or clockwise to decrease the mV pressure.

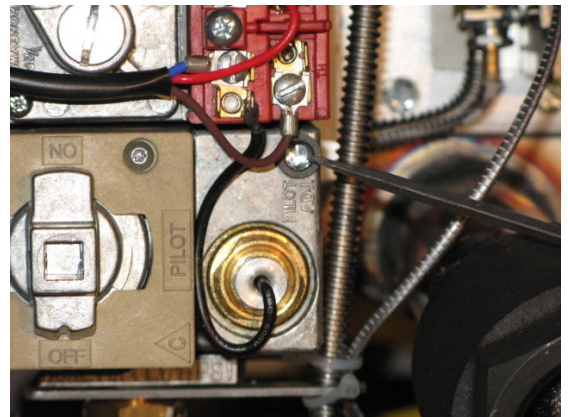

4. Disconnect the multimeter.

## Replacing the Thermostat

1. Remove the two (2) bolt clamp screws that hold down the temperature probes using a Phillips screwdriver.

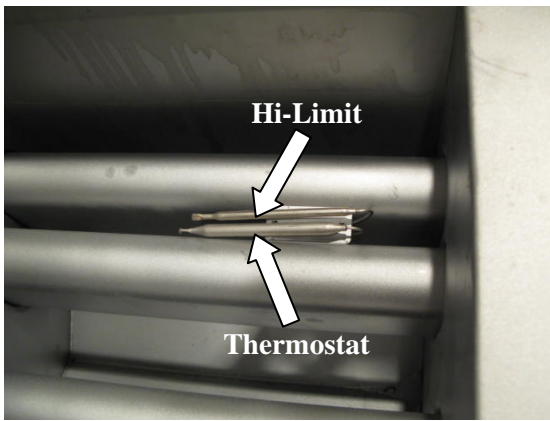

2. Remove the two (2) screws on the thermostat using a 5/16 inch socket.



3. Remove the thermostat knob.



4. Remove the two (2) screws that hold the thermostat using a Phillips screwdriver.

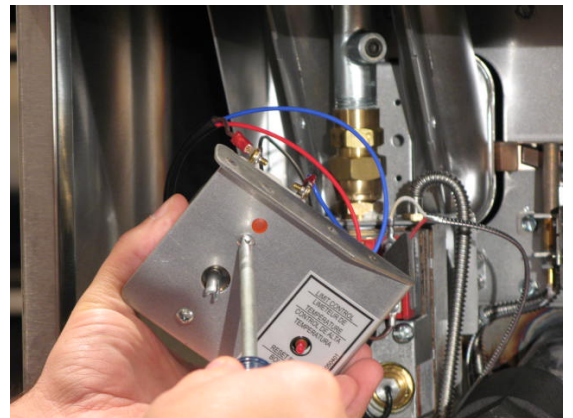

5. Pull out the thermostat.

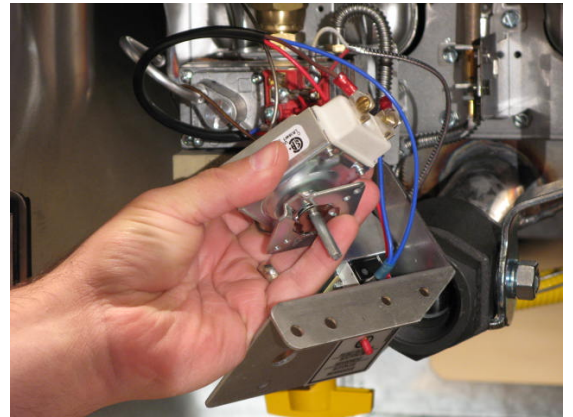

6. Remove the two (2) screws that hold the wires using a flathead screwdriver.

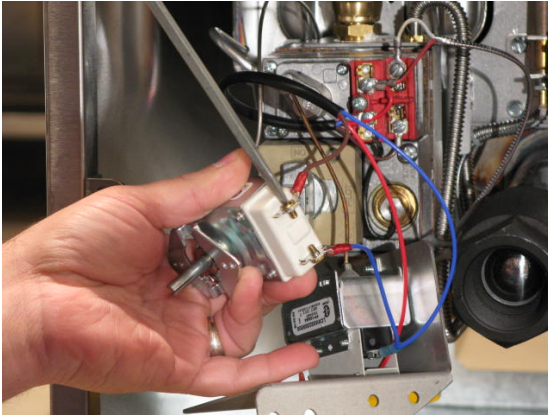

9. Apply Fluoropolymer paste to the fitting.



7. Remove the capillary nut using a 5/16 inch close-ended wrench.

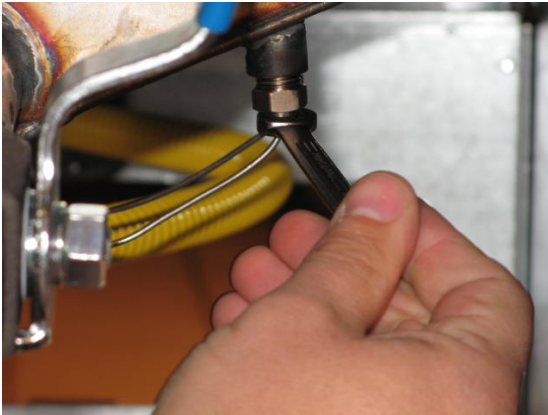

10. Remove and replace the temperature bulb.



8. Remove the grand nut using a 9/16 inch open-ended wrench.

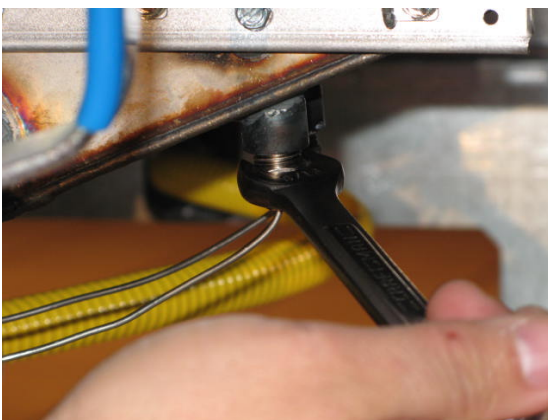

11. Finger tighten the fitting.



12. Make sure the temperature bulb(s) are in the correct location.



13. Reinstall the two (2) bolt clamp screws using a Phillips screwdriver.



#### NOTES:

**Hi limit and thermostat capillaries should not be in contact with the heat tubes.**

**Make sure the bulbs are centered in the bolt clamp before tightening the screws.**

**Make sure the thermostat bulb is mounted on the welded side of the tapping pad.**

14. Follow steps 2 through 11 in reverse.

15. Calibrate the thermostat.

## Calibrating the Thermostat

1. Remove thermostat knob.

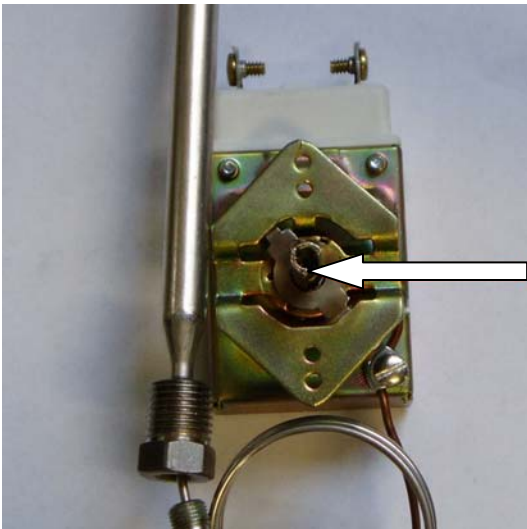

2. Rotate adjustment screw 90 degrees at a time to match set temperature. Clockwise to decrease temperature, counter-clockwise to increase temperature.

3. Replace knob.

## Replacing the Hi-Limit Thermostat

---

1. Remove the two (2) bolt clamp screws on the hi-limit probes using a Phillips screwdriver.



2. Remove the two (2) screws, which hold the high-limit thermostat, using a Phillips screwdriver.

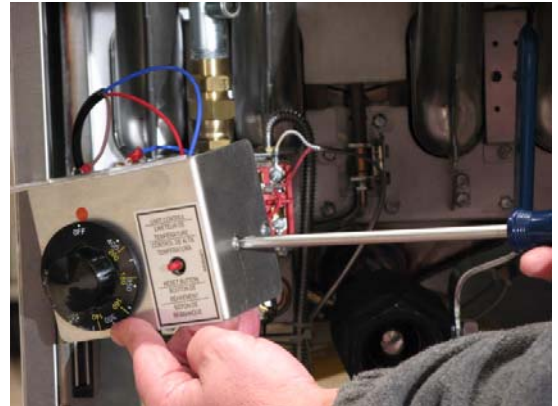

3. Remove the two (2) screws, which hold the wires, using a flathead screwdriver.

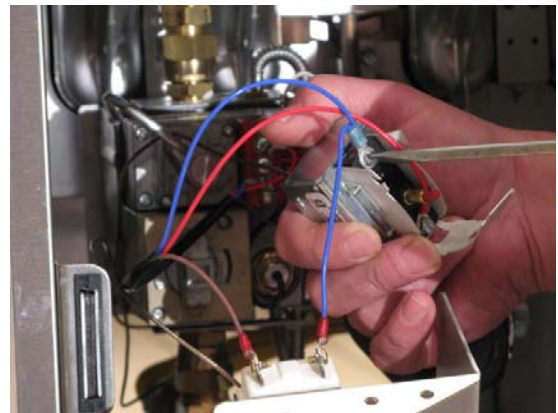

4. Replace the high-limit thermostat by following steps 1 through 3 in reverse.

# Filter System

## Replacing the Return Valve

---

**IMPORTANT:** Oil must be removed from the tank before replacing the return valve.

1. Remove all connections from the 3-way return valve using a 1/16 inch wrench.

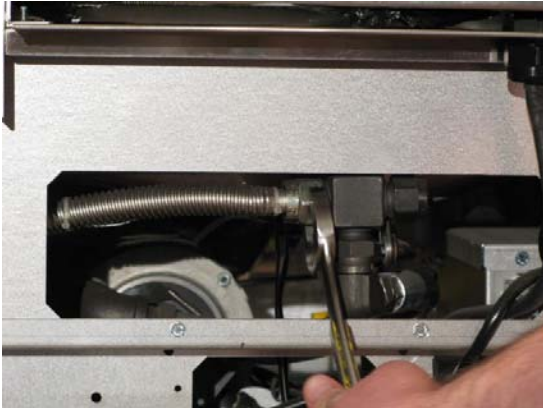

2. Remove the cotter pin on return valve using needle-nose pliers.



3. Replace the return valve by following steps 1 through 2 in reverse, replacing the cotter pin if necessary.

**NOTE:** Thread sealant is not required for these fittings.

## Replacing the Flush Hose Assembly and Valve

---

1. Remove the lower connection at the 3-way return valve in the back of the unit using a 15/16 inch wrench.

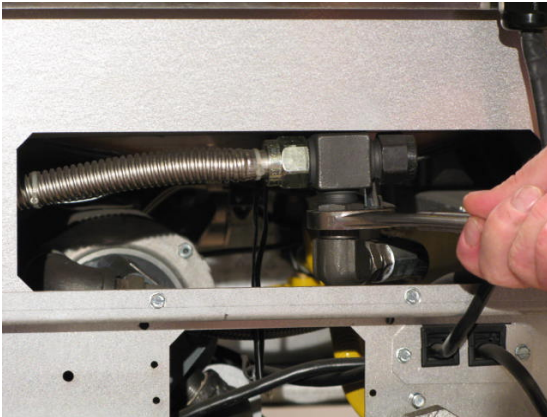

2. Remove the male quick disconnect using a 15/16 inch wrench.

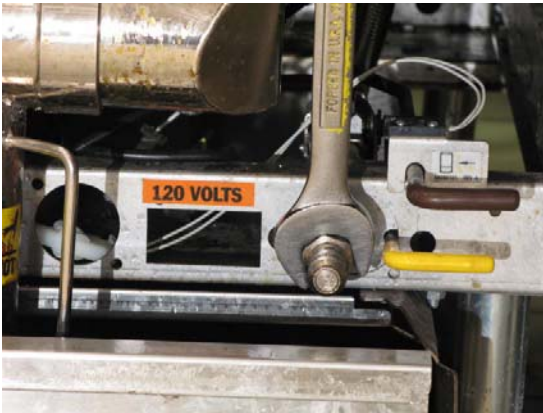

3. Unplug the proximity switch.

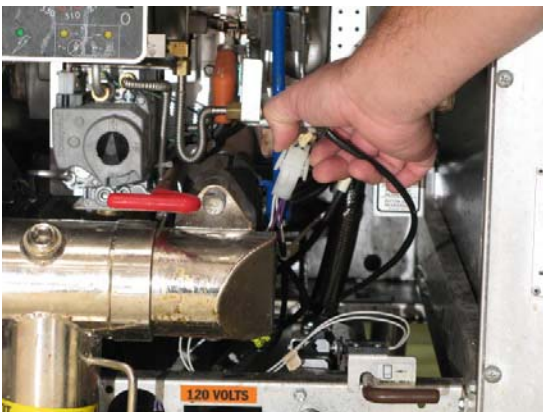

4. Remove two (2) screws holding the flush hose assembly using a 5/16 socket.

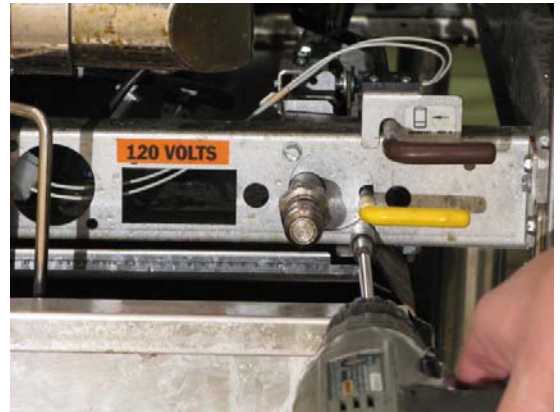

5. Remove the flush hose assembly.
6. Remove the four (4) screws from the magnets using a flathead screwdriver.

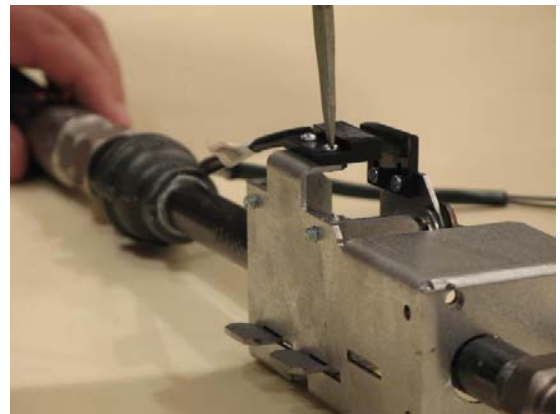

7. Remove the two (2) screws from the valve mounting brackets using a 5/16 socket.

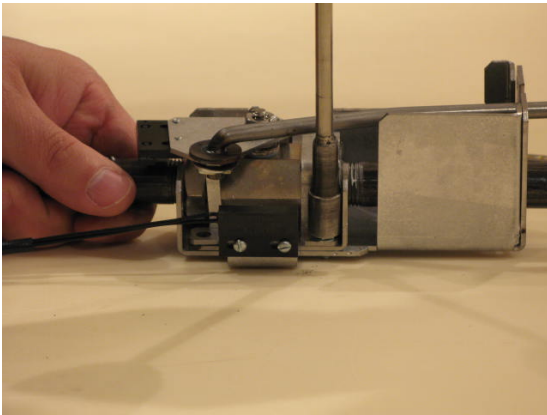
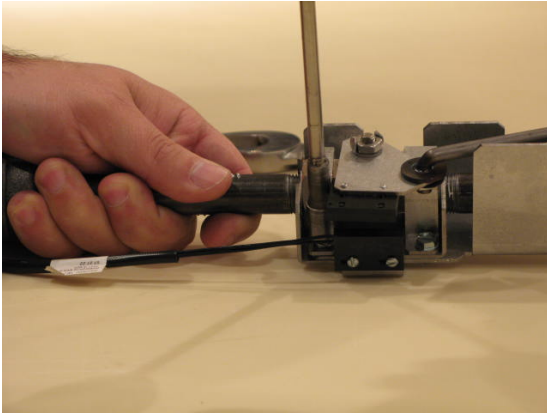

8. Slide the bracket to the back of the assembly.

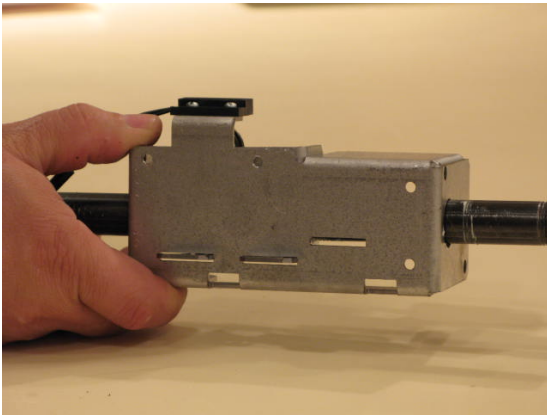

9. Lift bracket out and slide forward.

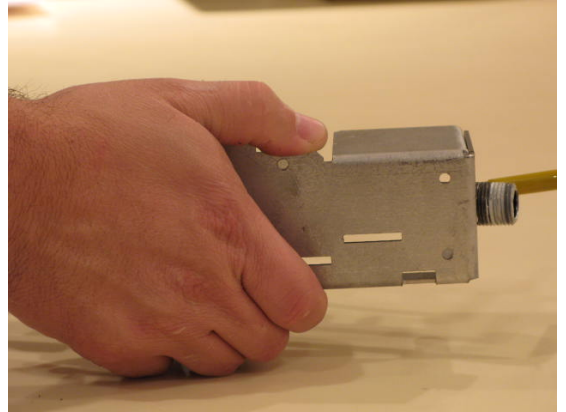

10. Bend down tabs of the stem nut washer using a needle-nose plier.

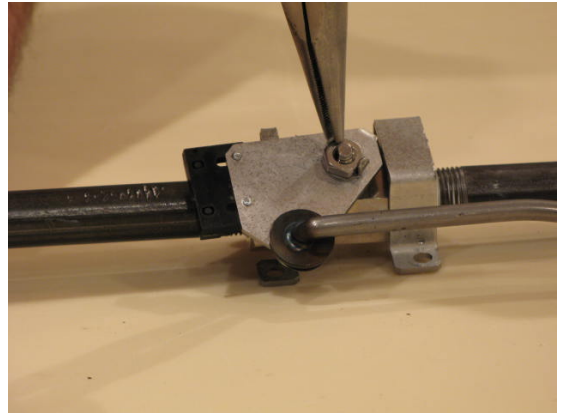

11. Remove the nut using a 7/16 inch wrench.

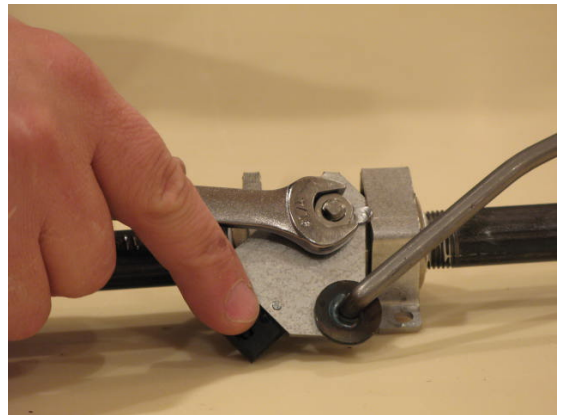

12. Remove the handle.

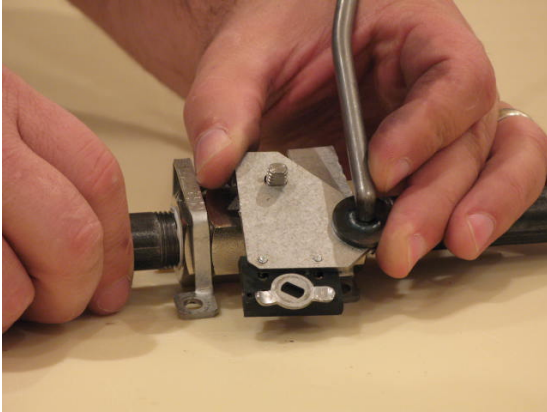

13. Remove the mounting bracket.

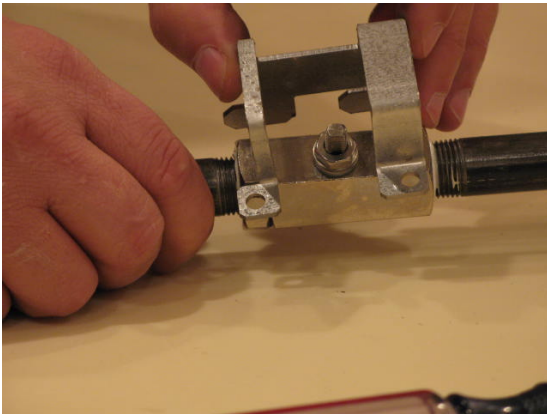

14. Remove the piping using a 15/16 inch wrench on the valve and an adjustable wrench on the piping.

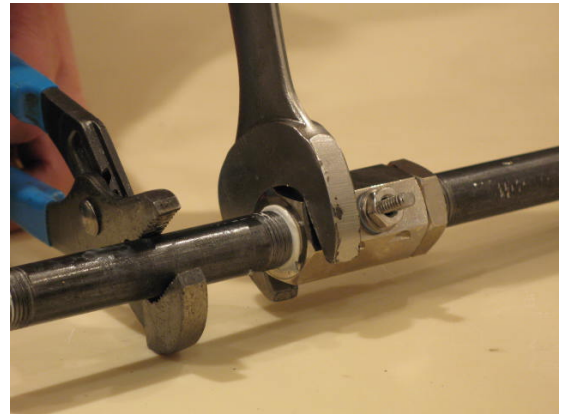

15. Replace the flush hose assembly and valve by following steps 1 through 14 in reverse.

## Replacing the Heat Tape

---

**NOTE:** See “Simplified Wiring Diagrams” starting on page 89.

1. Disconnect plug from pump box.
2. Wrap the new heat tape the same way as it was before.



## Replacing the Waste Oil and Components

---

### Removing Rear Mounting Bracket

---

1. Remove six (6) screws using a 5/16 socket wrench.

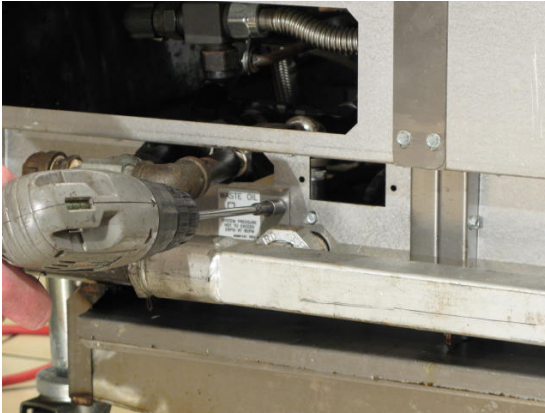

2. Disconnect from the filter return line using a 1-1/16 inch wrench.

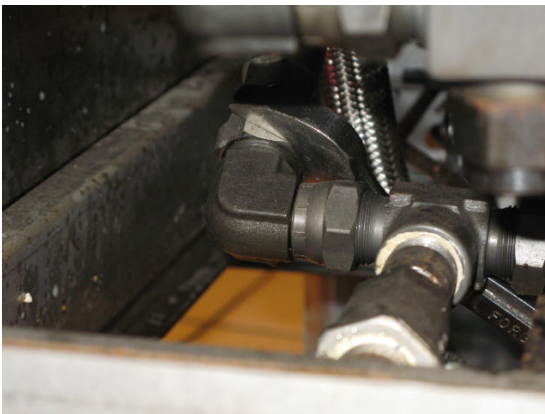

3. Remove two (2) screws with a 5/16 socket wrench.



## Removing the Check Valve

---

1. Remove the 3/8 inch nipple using an adjustable wrench.

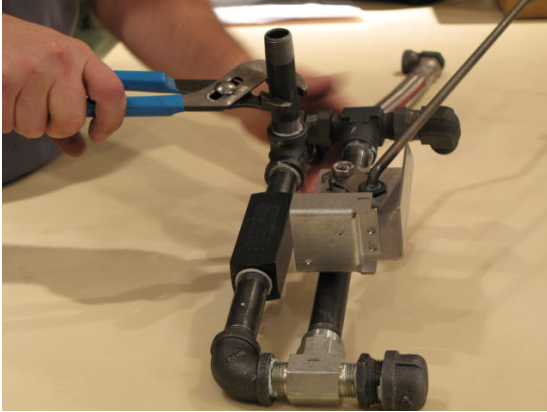

2. Remove the second nipple using two adjustable wrenches.

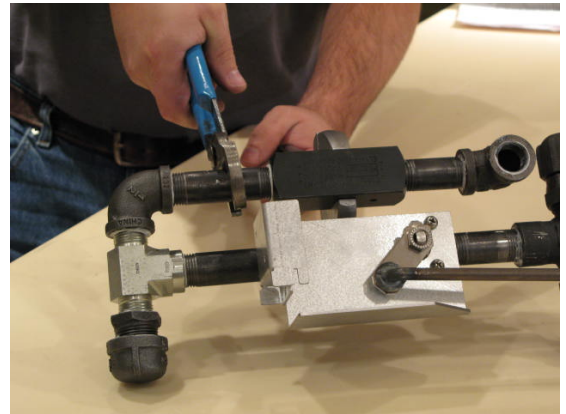
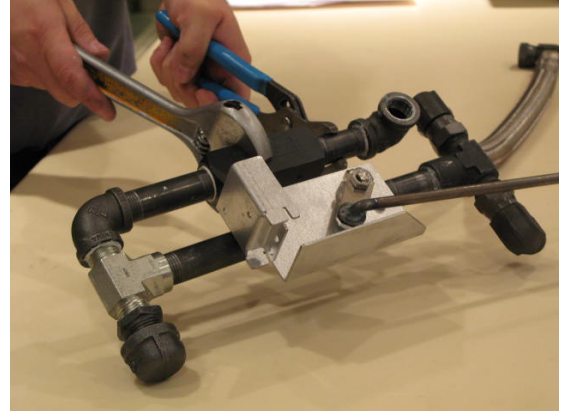

3. Remove the valve nut using a 9/16 inch open-ended wrench.



4. Remove the valve lever.

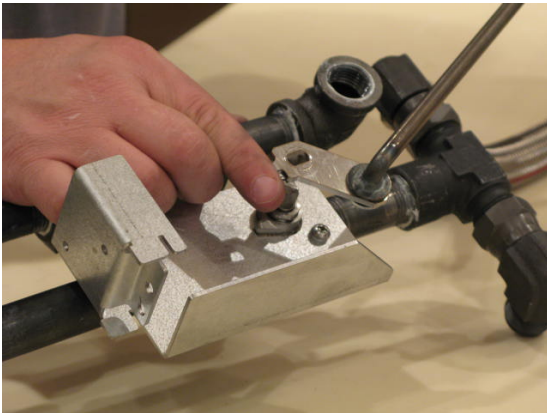

5. Remove the two (2) screws using a Phillips screwdriver.

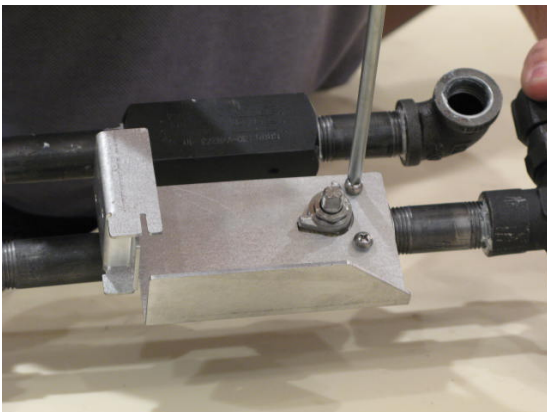

6. Lift off the mounting bracket.



7. Remove the valve using two adjustable wrenches.



8. Follow steps 1 through 7 in reverse to reinstall.

## Replacing the Filter Pump and Motor

### Removing the Filter Pump and Motor

1. Loosen the pump inlet tube using a crescent wrench.

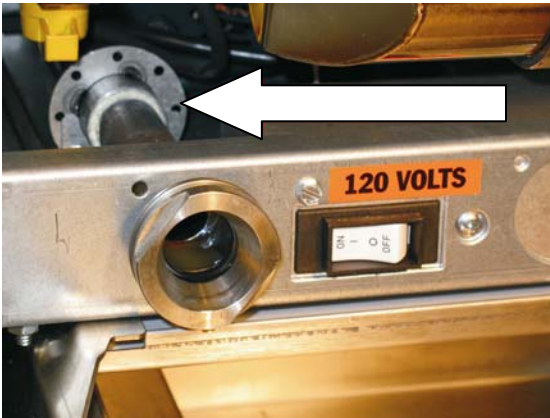

2. Unscrew and remove the inlet valve of the filter pump system.



3. Pull out pump inlet tube.



4. Remove filter pan cover (not shown).
5. Disconnect the connections and power supply cords from the filter pump.

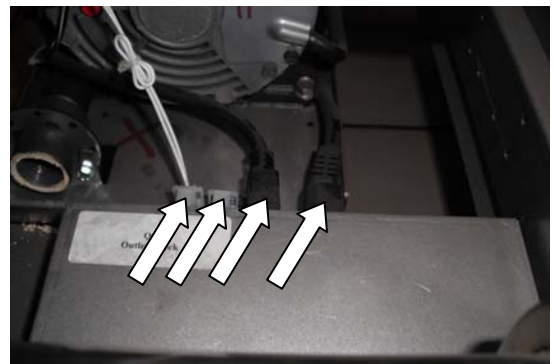

6. Remove the lower connection at the 3-way return valve using a 15/16 inch wrench.



7. Remove one (1) screw, which holds the bracket, using a 5/16 inch socket.



8. Remove the bracket.

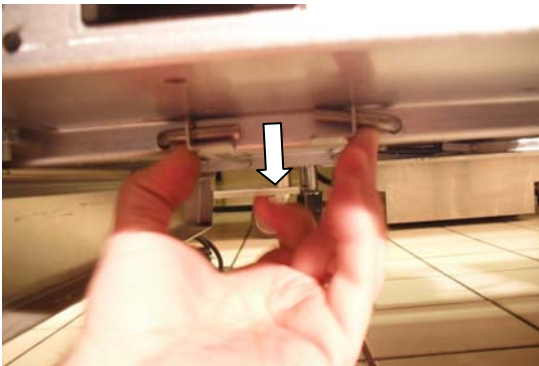

**NOTE:** The filter pump will fall to the floor once the pins are pulled out. It is recommended that you brace the pump and motor before pulling out the pins.

9. Turn down the pins and then pull them out.

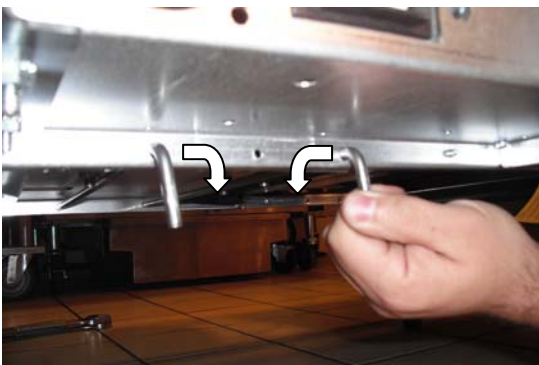

10. Lower the filter pump to the floor and then pull it out.

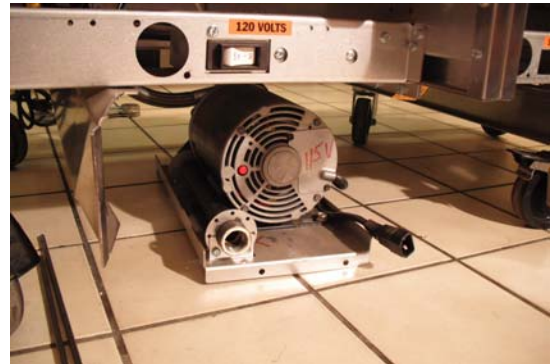

11. Remove the three (3) bolts on the bottom of the filter pump base using a 1/2 inch open-ended wrench.

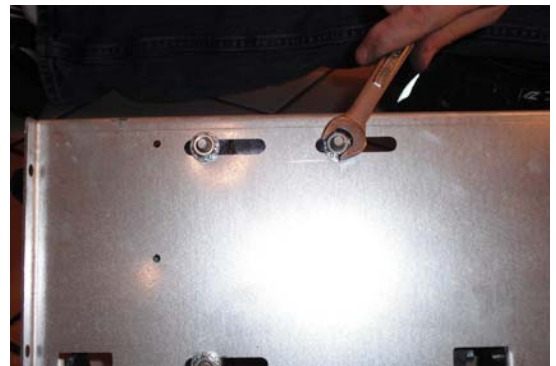

12. Remove two (2) screws on back of filter pump using a 5/16 inch socket.



13. Remove existing piping from old filter pump using two adjustable wrenches.



14. Reinstall a new filter pump by following steps 1 through 13 in reverse.

## Replacing Seal Kit

---

1. Remove the four (4) bolts on filter pump using 7/16 inch open-ended wrench.



2. Remove the filter pump head.



3. Replace the seal.



4. Reinstall the filter pump head to the motor by following steps 1 through 2 in reverse.

## Removing the Filter Pump from the Motor

---

1. Remove the two (2) bolts holding the filter pump head to the motor using a 1/2 inch open-ended wrench.



2. Remove the filter pump head from the motor.

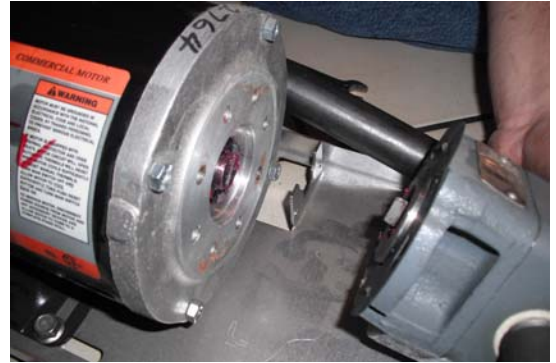

3. Reinstall the filter pump head to the motor by following steps 1 through 2 in reverse.

## Replacing the Return Switch

---

1. Disconnect all the wires from the gas valve, pilot, and SCB valve.
2. Drop the gas valve from the manifold.
3. Remove the two (2) screws, which hold the return valve handle, using a 5/16 inch socket.

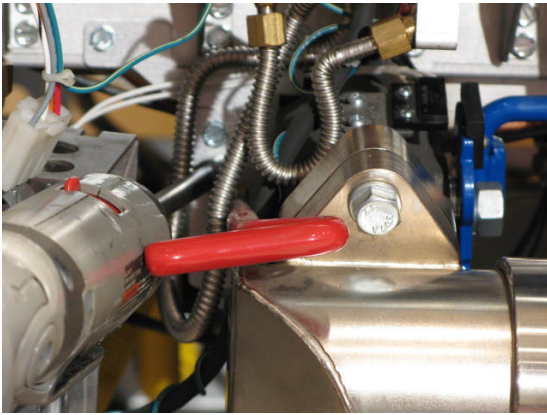

4. Remove the return valve handle bracket.

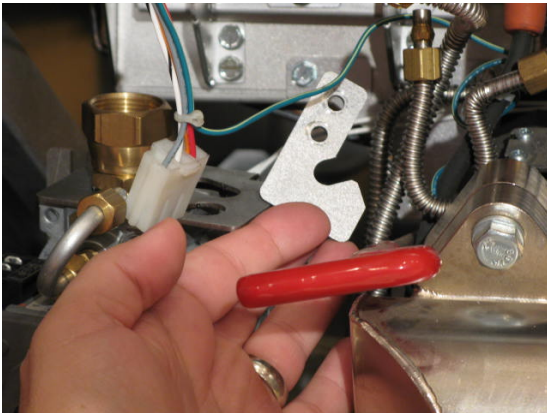

5. Remove the two (2) screws, which hold the mounting bracket, using a 5/16 inch socket

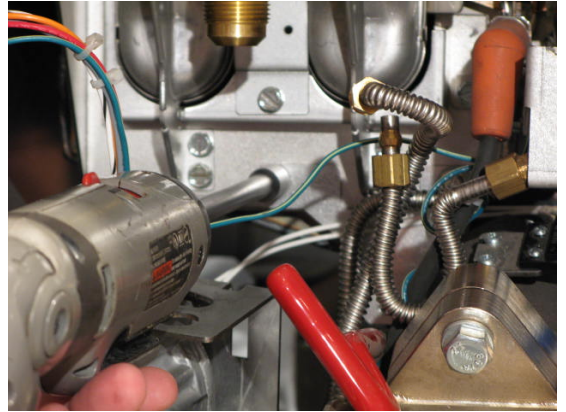

6. Remove the mounting bracket.

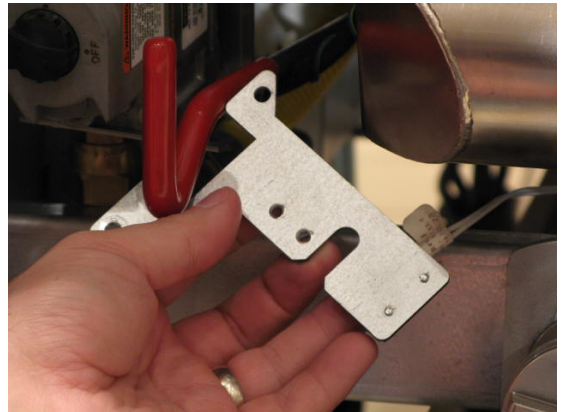

7. Disconnect the mounting bracket wire from the pump box (not shown).

8. Turn the mounting bracket over and remove the two (2) screws, which hold the actuator, using a flathead screwdriver.

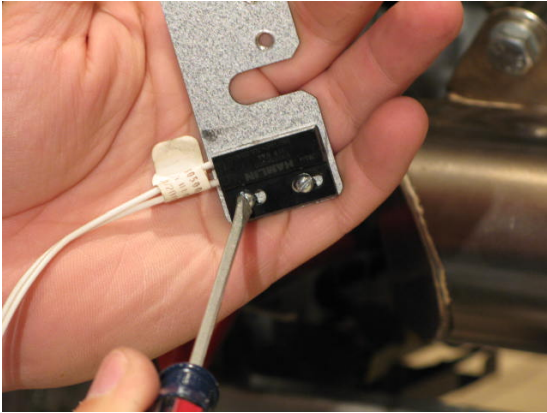

9. Remove all connections from the 3-way return valve using a 1/16 inch wrench.

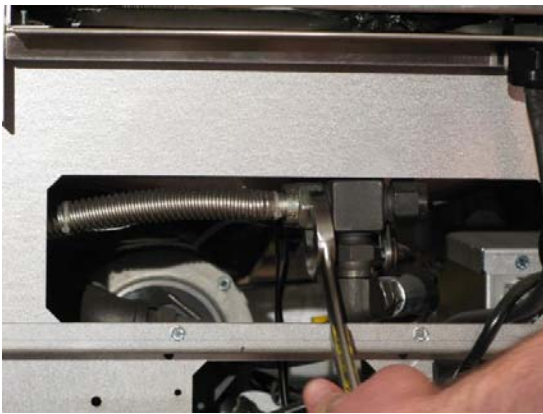

10. Remove the cotter pin on return valve using needle-nose pliers.



11. Pull the red return handle out of the fryer.

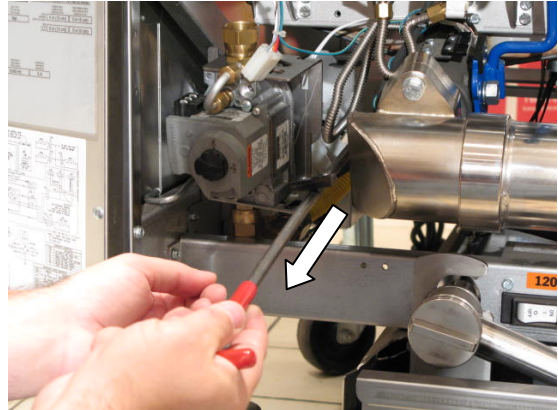

12. Remove the two (2) screws, which hold the magnet on the handle, using a flathead screwdriver.

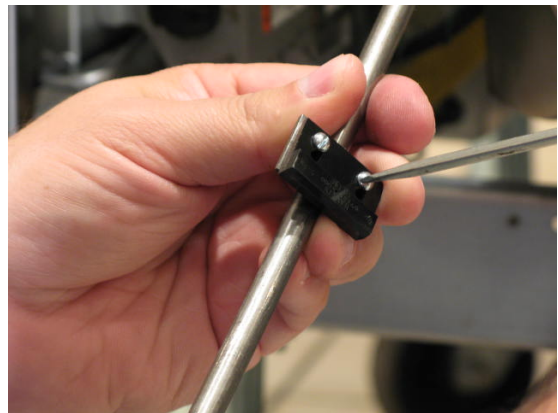

13. Reinstall the new return switch by following steps 1 through 12 in reverse.

## Replacing the Drain Line or Gasket

---

1. Remove one (1) screw on the drain line using a 7/16 inch wrench.



2. Lift off the drain manifold clamp.



3. Slide off the drain manifold gasket.



4. Slide out the drain line.
5. Reinstall the new drain line by following steps 1 through 4 in reverse to.

## Replacing the Pump Relay and Circuit Breaker

---

### Replacing the Circuit Breaker

---

1. Disconnect the connections and power supply cords from the filter pump.

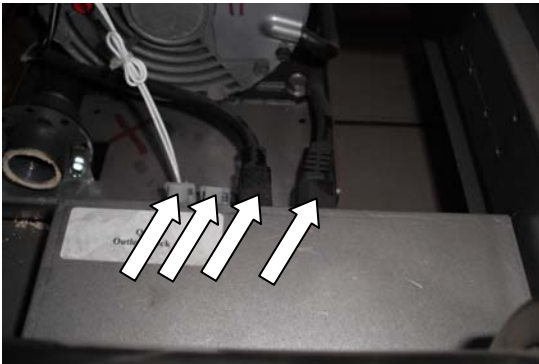

2. Remove the pump box.



3. Remove the circuit breaker from the pump box.



4. Remove all wires on the circuit breaker using needle-nose pliers.



5. Squeeze the tabs on the circuit breaker and push it out.

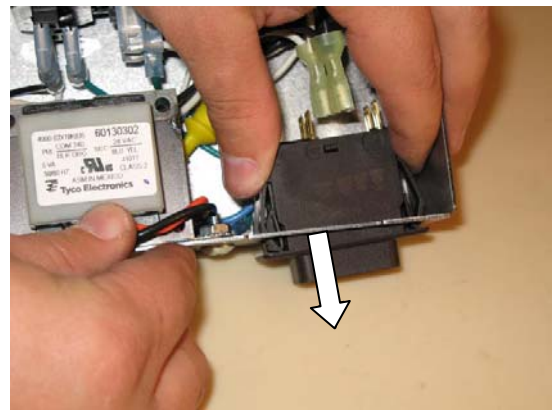

6. Reinstall the new circuit breaker by following steps 1 through 5 in reverse.

## Replacing the Pump Relay

---

1. Remove the two (2) screws, which hold the pump relay, using a Phillips screwdriver.



2. Remove all wires on the pump relay using needle-nose pliers. See “Simplified Wiring Diagrams on page 89” **Error! Bookmark not defined.**



3. Remove the pump relay.
4. Reinstall the new pump relay by following steps 1 through 2 in reverse.

# **Troubleshooting and Problem Isolation**

# Troubleshooting and Problem Isolation

## Interpretation of Solid State Controller Lights

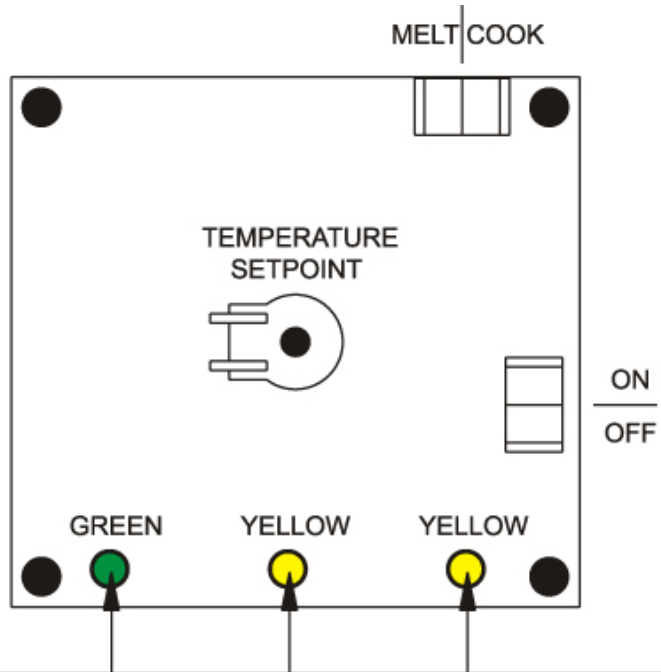

| CONDITION             | POWER SWITCH POSITION | POWER INDICATOR (GREEN) | HEAT DEMAND (YEL) | HEAT FEED BACK/FAULT (YEL) | DC OUTPUTS |                 |
|-----------------------|-----------------------|-------------------------|-------------------|----------------------------|------------|-----------------|
|                       |                       |                         |                   |                            | SIDE ON    | HEAT DEM        |
| NORMAL OPERATION      | OFF                   | OFF                     | OFF               | OFF                        | OFF        | OFF             |
|                       | ON                    | ON                      | *ON AS REQUIRED   | FOLLOWS HEAT DEM           | ON         | *ON AS REQUIRED |
| DRAIN SWITCH OPEN     | OFF                   | OFF                     | OFF               | 7 FLASHES /PAUSE REPEAT    | OFF        | OFF             |
|                       | ON                    | OFF                     | OFF               |                            | OFF        | OFF             |
| PROBE OPEN OR SHORTED | OFF                   | OFF                     | OFF               | 3 FLASHES /PAUSE REPEAT    | OFF        | OFF             |
|                       | ON                    | OFF                     | OFF               |                            | OFF        | OFF             |
| HIGH LIMIT TRIPPED    | ON                    | ON                      | ON                | OFF                        | ON         | ON              |

\*FOR VAT TEMPERATURES ABOVE SET POINT, HEAT DEMAND WILL BE OFF.



## Component Troubleshooting

---

The following sections provide troubleshooting information for the fryer components.

### Probe

---

The resistance of the probe changes as the temperature changes. The resistance decreases as the temperature rises.

If the probe is suspect, check its resistance and the oil temperature (as close to the probe as possible) at which it was taken. Compare these values to the values in the probe resistance chart.

If the probe returns an open circuit or a 0  $\Omega$  reading, replace it. If the resistance varies more than 30  $\Omega$  when checked in the range of 325°F to 375°F (163°C to 191°C), the probe gives a false temperature reading on the computer. Calibrate the probe up to 10°F or replace it; however, the probe continues to operate at a slightly higher or lower temperature. See “Probe Resistance Chart” on page 85.

Allow the oil to cool and check the probe resistance at a lower temperature. Looking at the probe resistance chart, a greater resistance variation is tolerated at a lower temperature.

### Roll Out Switch

---

The rollout switch is located between the two center burners just above the pilot assembly. The normal temperature for this area is in the range of 150°F to 170°F (66°C to 77°C). The rollout switch trips at an ambient temperature of 212°F (100°C) and interrupts the neutral side of the SO relay (the relay that controls the pilot). Check the temperature with a probe in the general area that the switch is located with the door closed. If higher temperatures occur, the following issues may be the cause:

- SCB Solenoid is stuck in the open position.
- SCB relay is stuck in the “NO” position.
- Down draft on the flue.
- Blockage in the flue or heat tubes.
- There is not an 18 inch minimum clearance above the flue to any obstruction.

### Gas Valve

---

The gas valve has a dual 24 VAC operator and opens when the correct voltage is supplied to the operator.

With 24 VAC applied across the PV-MV/PV connections, the pilot valve operator opens, allowing gas to flow to the pilot. With 24 VAC applied across the MV- MV/PV connections, the main valve operator opens, allowing gas to flow to the main burners.

### Hi-Limit

---

The hi-limit switch is a closed switch until the temperature at the hi-limit bulb reaches 450°F  $\pm$ 15°F (232°C  $\pm$ 15°C). The oil temperature needs to drop approximately 45°F (7°C) before it resets. If it does not reset after the oil has cooled, it is defective.

---

## Drain Valve and Return Valve Switches

---

These switches are a magnetically operated proximity switches. When the drain valve handle is moved to the open position, the actuator moves away from the switch causing the switch to open. When the drain valve is closed, the switch closes.

Opening the RED return valve handle closes the proximity switch causing the “pump on” relay to be energized; the pump begins to pump. Closing the return valve handle opens the proximity switch causing the relay to de-energize and the pump to stop pumping. These switches can be checked with a  $\Omega$  meter. When the switch is closed, there should be continuity. The normal gap between the actuator and the sensor switch on the valve handle is 1/8 inch to 1/4 inch (3 mm to 6 mm).

---

## Transformer

---

The transformer is a multiple AC input voltage and 24 VAC output voltage. It can be checked by reading the input and output voltages. A quick check for 24 VAC is done at the relay board behind the front panel. The AC indicator is illuminated if the F1 fuse is good and the board is receiving 24 VAC.

---

## Ignition Module

---

With a 24 VAC input at pin #6, the ignition module has a 24 VAC output from terminal 3(PV) and the igniter sparks until the module senses the pilot flame or for approximately 90 seconds at which time the module locks out, whichever occurs first. When the module has proven the pilot flame, it has a 24 VAC output at terminal 1(MV) and put 24 VAC to pin 2 at connection J/P32 on the relay board. The relay board interrupts the 24 VAC to the gas valve until the controller calls for heat.

**NOTE: When the controller is on, the pilot should always remain lit.**

---

## Relay Board

---

**NOTE: J connectors are marked on the relay board.**

With 24 VAC supplied to pin #2 at connector J35 and a good F1 fuse, the relay board has a 24 VAC output at pin #2 on connectors J33 and J34 and the AC indicator is illuminated.

**NOTE: If the fryer is equipped with a computer or solid state digital, at connection J33 there is a jumper from pin #2 to pin #10 to supply 24 VAC to pin # 2 at connection J31 to supply the controller with 24 VAC.**

When the board receives a 24 VDC SO input at pin #7 on connector J31 or J33, the SO indicator is illuminated, the SO relay is energized, and there is a 24 VAC output at pin #4 on connector J32.

When the board receives a 24 VDC HD input at pin #6 on connector J31 or J33, the HD relay is energized and there is continuity between pin #1 and pin #2 at connector J32. The HD indicator is illuminated from the 24 VAC output from the HD relay NO contact.

**NOTE: The HD indicator does not illuminate if there is not a 24 VAC output from the MV terminal on the ignition module.**

## Computer Control

---

**NOTE: All controller test points are at connector P/J1 (closest connector to the controller).**

With 24 VAC supplied to pin #1(24 VAC supply) and pin #5 (24 VAC input from DVI), the display reads “OFF”.

With the controller is turned on, there is a 24 VDC output at pin #9 (SO).

When the controller calls for heat, there is a 24 VDC output at pin #8 (HD) and a 24 VAC input at pin #6 (HFB). If the controller does not receive the 24 VAC input at pin #6 in approximately 90 seconds, the controller displays “HEAT FAIL” or “IGNITION FAILURE”. This indicates a break in the HD or HFB circuit.

To correct, do the following:

1. Check the hi-limit switch. Is it open or tripped?
2. Check the ignition module (sensing pilot flame, locked out, 24 VAC at MV terminal).
3. Check the HD relay on the relay board. Is the HD relay energized continuity through COM and NO contacts?
  - If display reads “PROBE OP” “OPEN”,  $\Omega$  test the temperature probe. Check the wires and connectors between the probe and controller for continuity.
  - If display reads “SYSTEM” “FAILURE”,  $\Omega$  test the temperature probe, and the wires and connectors between the probe and controller for a short.
  - If display reads “DRAINING” “TURN OFF”, verify that the drain valve is closed, check the proximity switch on the drain valve, turn the fryer off, and then turn the fryer on.

## Digital Solid State Control

---

**NOTE: All controller test points are at connector P/J1 (closest connector to the controller).**

With 24 VAC supplied to pin #1(24VAC supply) and pin # 5(24VAC input from DVI), the display reads “OFF”.

With the controller turned on, there is a 24 VDC output at pin #9 (side on).

When the controller calls for heat, the display reads “HEAt”, there is a 24 VDC output at pin #8 (HD) and a 24 VAC input at pin #6 (HFB). If the controller does not receive the 24 VAC input at pin #6 in approximately 90 seconds, the controller displays “HEAT” “FAIL”. This indicates a break in the HD or HFB circuit.

To correct, do the following:

1. Check the hi-limit switch. Is it open or tripped?
2. Check the ignition module (sensing pilot flame, locked out, 24 VAC at MV terminal).
3. Check the HD relay on the relay board. Is the HD relay energized continuity through COM and NO contacts?

- If display reads “Prob”,  $\Omega$  test the temperature probe. Check the wires and connectors between the probe and controller for continuity.
- If display reads “Prob” “HI”,  $\Omega$  test the temperature probe, and the wires and connectors between the probe and controller for a short.
- If display reads “drn” “tUrn” “oFF”, verify that the drain valve is closed, check the proximity switch on the drain valve.

## Primary Solid State Control

---

**NOTE: All controller test points are at connector P/J3 (the 12 pin connector at the controller).**

24 VAC is supplied to the controller at pin #1(24VAC supply) and pin #5 (24 VAC input from DVI).

With the controller turned on, there is a 24 VDC output at pin #9 (SO) and the green indicator is illuminated.

When the controller calls for heat, there is a 24 VDC output at pin #8 (HD), the yellow indicator on the left is illuminated, and there is a 24 VAC input at pin #6 (HFB).

When the controller receives the 24 VAC input at pin #6, the yellow indicator on the right is illuminated. If the controller does not receive the 24 VAC input at pin #6, the indicator is not illuminated. This indicates a break in the HD or HFB circuit.

To correct, do the following:

1. Check the hi-limit switch. Is it open or tripped?
  2. Check the ignition module (sensing pilot flame, locked out, 24 VAC at MV terminal).
  3. Check the HD relay on the relay board. Is the HD relay energized continuity through COM and NO contacts?
- If the green and yellow indicators on the left are illuminated and then shut off when the controller is turned on, this indicates an open or shorted probe or wires in between the probe and the controller.
  - If none of the indicators illuminate when the controller is turned on, verify that the drain valve is closed and that the magnetic proximity switch has continuity when the drain valve is closed. Also verify that there is 24 VAC at pin #1 (24 VAC supply) and pin #5 (24 VAC input from DVI).

## Backup Solid State Control

---

The backup solid state control works the same as the primary solid state control, with the exception of the 24 VAC supply passing through the solid state backup transfer switch to the computer or solid state digital control.

If the transfer switch is set to backup or if the backup controller is unplugged, the primary controller does not work. The jumper must be installed on the relay board (connection J33) to allow the primary controller to function if the backup controller is removed.

## Optional Basket Lift

---

The basket lift is a self contained unit that requires a 120V, 208V, or 240V supply. With most fryer configurations, the power is supplied from the entrance box at the back of the fryer, but some configurations require power direct from a wall outlet.

When supply voltage is applied to the basket lift assembly, it goes through a voltage selector switch to a multi tap 24V, 80VA transformer. The transformer supplies 24 VAC to the driver board at connection J54.

**NOTE: When power is supplied to basket lift assembly, the baskets lifts to the up position.**

When a timer is activated, it sends a 24 VDC signal to pin #1 (24 VDC+) at connector J51 on the driver board. The driver board generates a 24 VDC output at J53 to the basket lift motor, lowering the basket.

**NOTE: For the purpose of testing, jumping pins #1 and #2 at connection J5 on the driver board will simulate a 24 VDC signal from the controller, lowering the basket.**

## Probe Resistance Chart

| Probe Resistance in 5°F Increments. |                 |                   |                 |                 |                   |                 |                 |                   |
|-------------------------------------|-----------------|-------------------|-----------------|-----------------|-------------------|-----------------|-----------------|-------------------|
| Probe Temp (°F)                     | Probe Temp (°C) | Resistance (Ohms) | Probe Temp (°F) | Probe Temp (°C) | Resistance (Ohms) | Probe Temp (°F) | Probe Temp (°C) | Resistance (Ohms) |
| 10                                  | -12.2           | 562734            | 175             | 79.4            | 11719             | 340             | 171.1           | 1058.23           |
| 15                                  | -9.4            | 483875            | 180             | 82.2            | 10716             | 345             | 173.9           | 998.09            |
| 20                                  | -6.7            | 417167            | 185             | 85.0            | 9812              | 350             | 176.7           | 942.00            |
| 25                                  | -3.9            | 360589            | 190             | 87.8            | 8995              | 355             | 179.4           | 889.67            |
| 30                                  | -1.1            | 312474            | 195             | 90.6            | 8255              | 360             | 182.2           | 840.78            |
| 35                                  | 1.7             | 271446            | 200             | 93.3            | 7586              | 365             | 185.0           | 795.10            |
| 40                                  | 4.4             | 236370            | 205             | 96.1            | 6979              | 370             | 187.8           | 752.38            |
| 45                                  | 7.2             | 206311            | 210             | 98.9            | 6427              | 375             | 190.6           | 712.41            |
| 50                                  | 10.0            | 180491            | 215             | 101.7           | 5926              | 380             | 193.3           | 674.95            |
| 55                                  | 12.8            | 158252            | 220             | 104.4           | 5470              | 385             | 196.1           | 639.87            |
| 60                                  | 15.6            | 139055            | 225             | 107.2           | 5055              | 390             | 198.9           | 606.96            |
| 65                                  | 18.3            | 122489            | 230             | 110.0           | 4675              | 395             | 201.7           | 576.09            |
| 70                                  | 21.1            | 108051            | 235             | 112.8           | 4329              | 400             | 204.4           | 547.09            |
| 75                                  | 23.9            | 95539             | 240             | 115.6           | 4013              | 405             | 207.2           | 519.86            |
| 80                                  | 26.7            | 84644             | 245             | 118.3           | 3723              | 410             | 210.0           | 494.24            |
| 85                                  | 29.4            | 75136             | 250             | 121.1           | 3458              | 415             | 212.8           | 470.16            |
| 90                                  | 32.2            | 66823             | 255             | 123.9           | 3214              | 420             | 215.6           | 447.49            |
| 95                                  | 35.0            | 59540             | 260             | 126.7           | 2991              | 425             | 218.3           | 426.13            |
| 100                                 | 37.8            | 53146             | 265             | 129.4           | 2785              | 430             | 221.1           | 406.02            |
| 105                                 | 40.6            | 47523             | 270             | 132.2           | 2597              | 435             | 223.9           | 387.04            |
| 110                                 | 43.3            | 42569             | 275             | 135.0           | 2422              | 440             | 226.7           | 369.14            |
| 115                                 | 46.1            | 38195             | 280             | 137.8           | 2262              | 445             | 229.4           | 352.24            |
| 120                                 | 48.9            | 34328             | 285             | 140.6           | 2113.9            | 450             | 232.2           | 336.29            |
| 125                                 | 51.7            | 30902             | 290             | 143.3           | 1977.3            | 455             | 235.0           | 321.21            |
| 130                                 | 54.4            | 27862             | 295             | 146.1           | 1851.0            | 460             | 237.8           | 306.94            |
| 135                                 | 57.2            | 25161             | 300             | 148.9           | 1734.3            | 465             | 240.6           | 293.46            |
| 140                                 | 60.0            | 22755             | 305             | 151.7           | 1626.1            | 470             | 243.3           | 280.69            |
| 145                                 | 62.8            | 20610             | 310             | 154.4           | 1525.9            | 475             | 246.1           | 268.61            |
| 150                                 | 65.6            | 18695             | 315             | 157.2           | 1433.0            | 480             | 248.9           | 257.15            |
| 155                                 | 68.3            | 16981             | 320             | 160.0           | 1346.7            | 485             | 251.7           | 246.30            |
| 160                                 | 71.1            | 15446             | 325             | 162.8           | 1266.6            | 490             | 254.4           | 236.00            |
| 165                                 | 73.9            | 14069             | 330             | 165.6           | 1192.1            | 495             | 257.2           | 226.24            |
| 170                                 | 76.7            | 12823             | 335             | 168.3           | 1122.8            | 500             | 260.0           | 216.96            |

**NOTE:** Resistance, of either probe lead, to the frame of the appliance should read as “open” on the meter. Typically this is 1Meg ohms or more.  
 $^{\circ}\text{C} = 5/9 (^{\circ}\text{F}-32)$   
 $^{\circ}\text{F} = (9/5 * ^{\circ}\text{C}) +32$

## Orifice Size Chart

| Model   | Gas Type | Main Burner Orifice | Model   | Gas Type | Main Burner Orifice |
|---------|----------|---------------------|---------|----------|---------------------|
| SGC     | Nat      | #43                 | SGM24   | Nat      | #42                 |
|         | LP       | #54                 |         | LP       | 1.45mm              |
| SG14    | Nat      | #41                 | SGM34   | Nat      | #42                 |
|         | LP       | #53                 |         | LP       | 1.5 mm              |
| SG14R   | Nat      | #38                 | SSH55   | Nat      | #46                 |
|         | LP       | .062"               |         | LP       | #55                 |
| SG14T   | Nat      | #43                 | SSH55T  | Nat      | #46                 |
|         | LP       | 1.45 mm             |         | LP       | #55                 |
| SG18    | Nat      | #41                 | SSH55R  | Nat      | #43                 |
|         | LP       | #53                 |         | LP       | 1.45 mm             |
| SG18F   | Nat      | #41                 | SSH55TR | Nat      | #43                 |
|         | LP       | #53                 |         | LP       | 1.45 mm             |
| SG6H    | Nat      | #41                 | SSH60   | Nat      | #46                 |
|         | LP       | #53                 |         | LP       | #55                 |
| MGII    | Nat      | #46                 | SSH60R  | Nat      | #43                 |
|         | LP       | #55                 |         | LP       | 1.45 mm             |
| MGIIIT  | Nat      | #46                 | SSH60W  | Nat      | #46                 |
|         | LP       | #55                 |         | LP       | #55                 |
| SGH50   | Nat      | #46                 | SSH60WR | Nat      | #43                 |
|         | LP       | #55                 |         | LP       | 1.45 mm             |
| SGH50T  | Nat      | #46                 | SSH75   | Nat      | #45                 |
|         | LP       | #55                 |         | LP       | 1.35mm              |
| SG18HP  | Nat      | #45                 | SSH75R  | Nat      | #43                 |
|         | LP       | 1.35 mm             |         | LP       | 1.45 mm             |
| SGM1824 | Nat      | #40                 | SRTG    | Nat      | #42                 |
|         | LP       | 0.0625"             |         | LP       | #53                 |

## Orifice Size at Sea Level Chart

| Orifice Size at Sea Level | Orifice Size Required at Other Elevations |      |      |      |      |      |      |      |        |
|---------------------------|---|------|------|------|------|------|------|------|--------|
|                           | 2000                                      | 3000 | 4000 | 5000 | 6000 | 7000 | 8000 | 9000 | 10,000 |
| 30                        | 30  | 31   | 31   | 31   | 31   | 32   | 32   | 33   | 35     |
| 31                        | 32  | 32   | 32   | 33   | 34   | 35   | 36   | 37   | 38     |
| 32                        | 33  | 34   | 35   | 35   | 36   | 36   | 37   | 38   | 40     |
| 33                        | 35  | 35   | 36   | 36   | 37   | 38   | 38   | 40   | 41     |
| 34                        | 35  | 36   | 36   | 37   | 37   | 38   | 39   | 40   | 42     |
| 35                        | 36  | 36   | 37   | 37   | 38   | 39   | 40   | 41   | 42     |
| 36                        | 37  | 38   | 38   | 39   | 40   | 41   | 41   | 42   | 43     |
| 37                        | 38  | 39   | 39   | 40   | 41   | 42   | 42   | 43   | 43     |
| 38                        | 39  | 40   | 41   | 41   | 42   | 42   | 43   | 43   | 44     |
| 39                        | 40  | 41   | 41   | 42   | 42   | 43   | 43   | 44   | 44     |
| 40                        | 41  | 42   | 42   | 42   | 43   | 43   | 44   | 44   | 45     |
| 41                        | 42  | 42   | 42   | 43   | 43   | 44   | 44   | 45   | 46     |
| 42                        | 42  | 43   | 43   | 43   | 44   | 44   | 45   | 46   | 47     |
| 43                        | 44  | 44   | 44   | 45   | 45   | 46   | 47   | 47   | 48     |
| 44                        | 45  | 45   | 45   | 46   | 47   | 47   | 48   | 48   | 49     |
| 45                        | 46  | 47   | 47   | 47   | 48   | 48   | 49   | 49   | 50     |
| 46                        | 47  | 47   | 47   | 48   | 48   | 49   | 49   | 50   | 50     |
| 47                        | 48  | 48   | 49   | 49   | 49   | 50   | 50   | 51   | 51     |
| 48                        | 49  | 49   | 49   | 50   | 50   | 50   | 51   | 51   | 52     |
| 49                        | 50  | 50   | 50   | 51   | 51   | 51   | 52   | 52   | 52     |
| 50                        | 51  | 51   | 51   | 51   | 52   | 52   | 52   | 53   | 53     |
| 51                        | 51  | 52   | 52   | 52   | 52   | 53   | 53   | 53   | 54     |
| 52                        | 52  | 53   | 53   | 53   | 53   | 53   | 54   | 54   | 54     |
| 0.062                     | 0.062                                     | 53   | 53   | 53   | 53   | 53   | 54   | 54   | 54     |
| 53                        | 54  | 54   | 54   | 54   | 54   | 54   | 55   | 55   | 55     |
| 54                        | 54  | 55   | 55   | 55   | 55   | 55   | 56   | 56   | 56     |
| 55                        | 55  | 55   | 55   | 56   | 56   | 56   | 56   | 56   | 57     |
| 56                        | 56  | 56   | 57   | 57   | 57   | 58   | 59   | 59   | 60     |
| 57                        | 58  | 59   | 59   | 60   | 60   | 61   | 62   | 63   | 63     |
| 58                        | 59  | 60   | 60   | 61   | 62   | 62   | 63   | 63   | 64     |
| 59                        | 60  | 61   | 61   | 62   | 62   | 63   | 64   | 64   | 65     |
| 60                        | 61  | 61   | 62   | 63   | 63   | 64   | 64   | 65   | 65     |

# Wiring Diagrams

# Simplified Wiring Diagrams

## Wiring Diagram – Full Vat with SCB

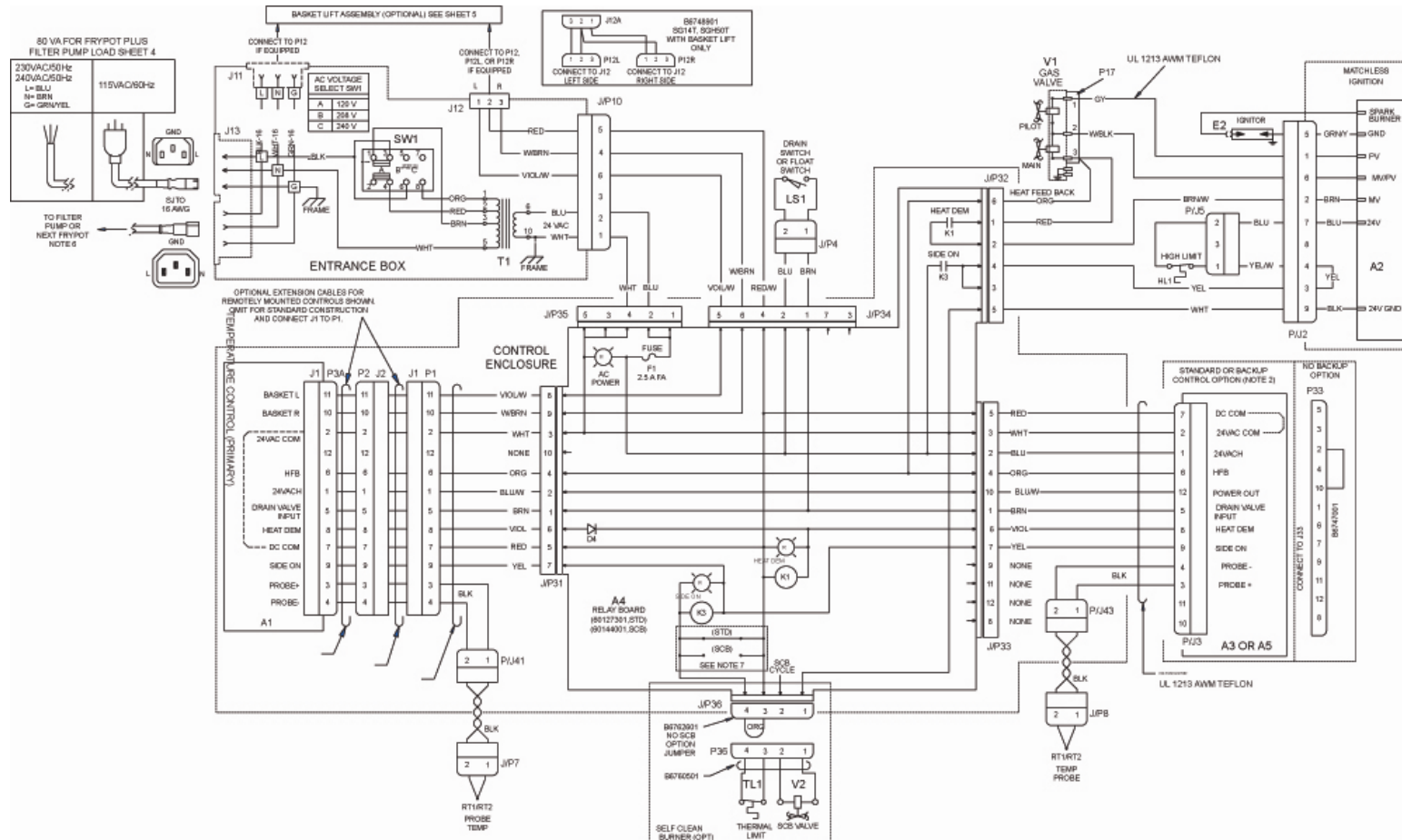

# Wiring Diagram – Twin Vat with SCB

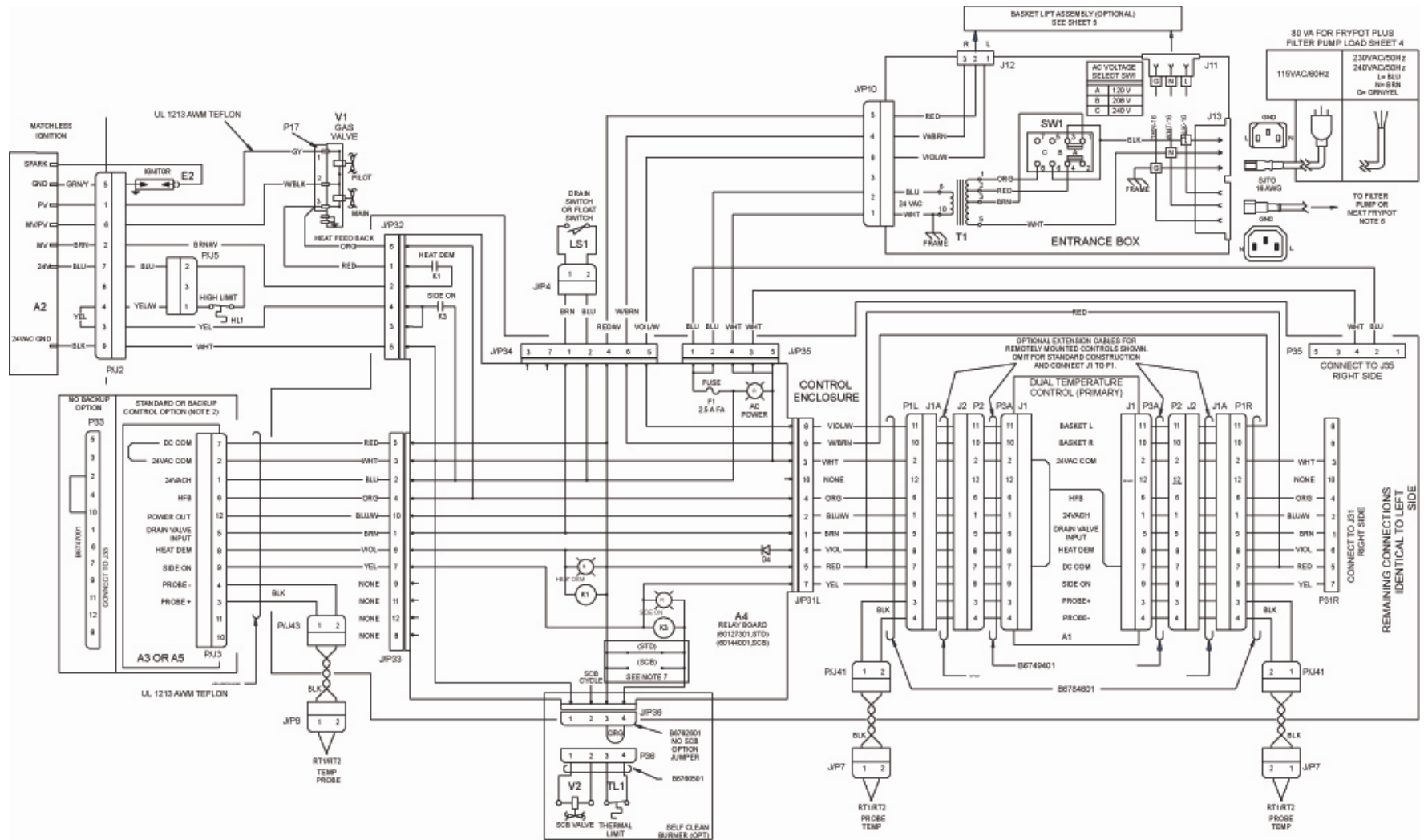

# Wiring Diagram – Basket Lifts

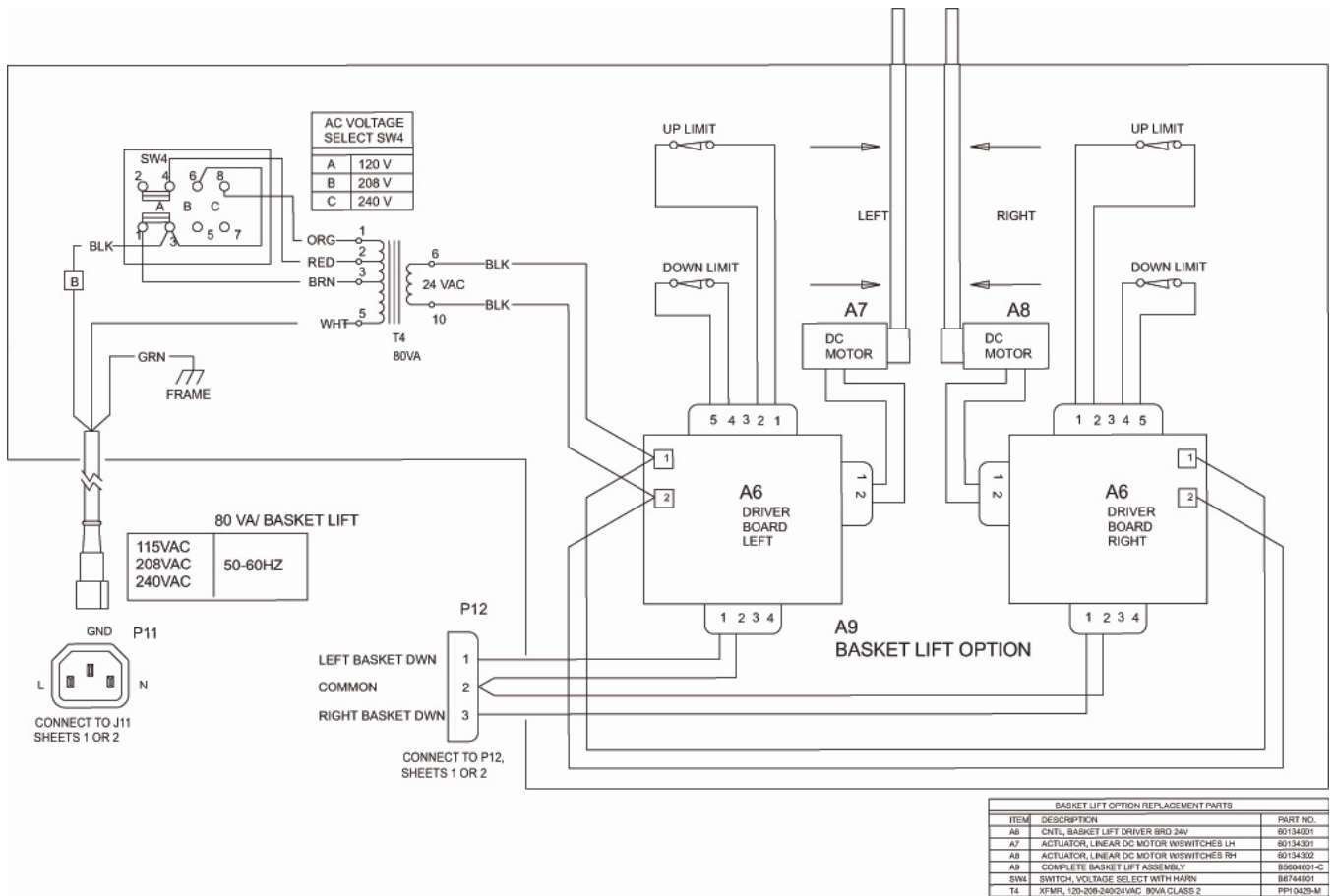

# Wiring Diagram – Filter Motor 115V-60Hz

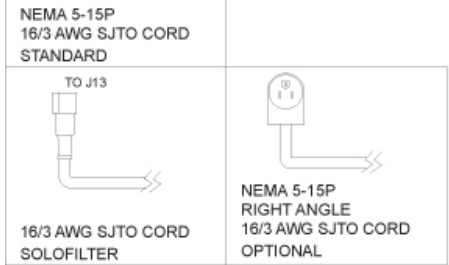
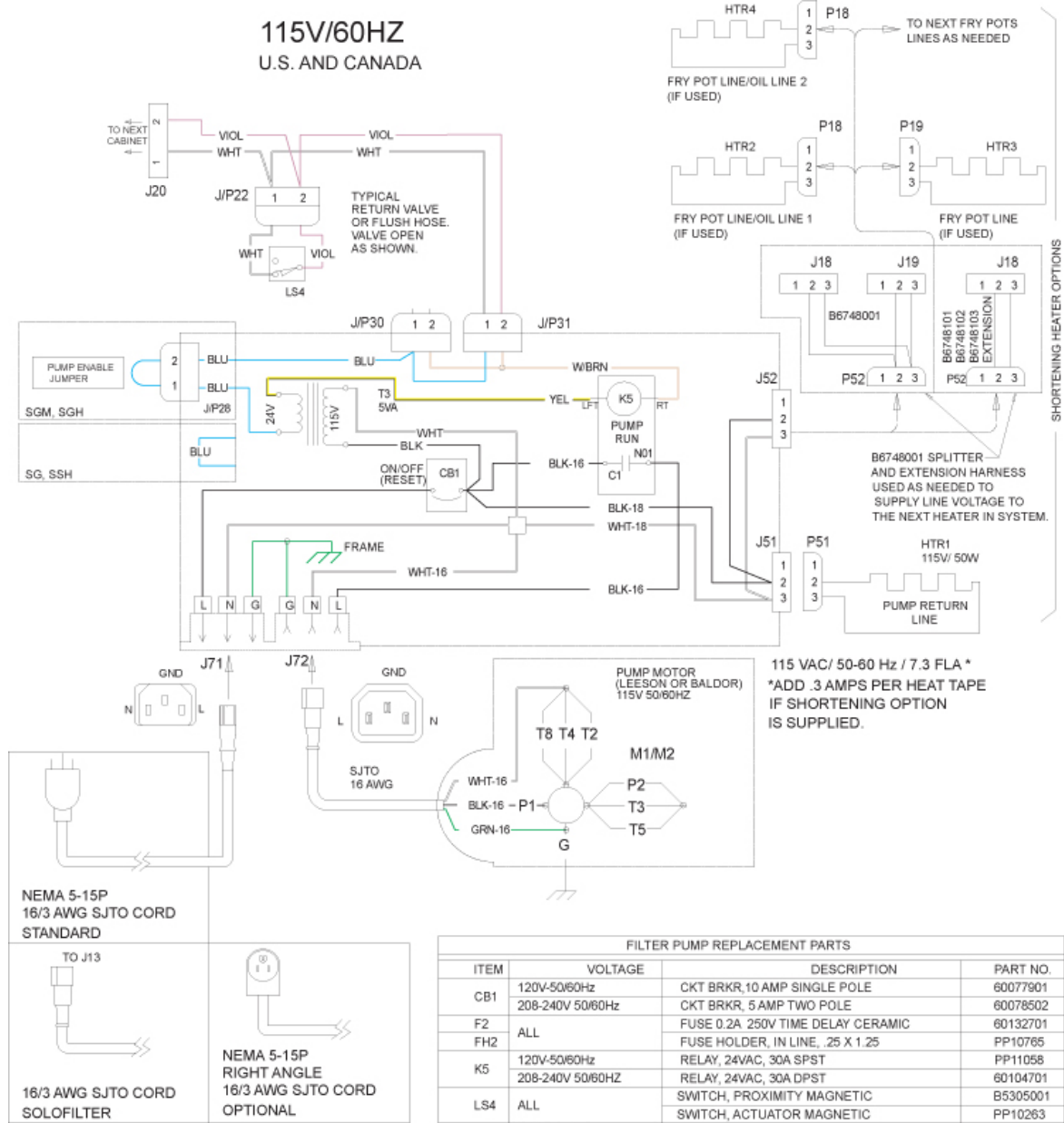

| FILTER PUMP REPLACEMENT PARTS |                  |                                   |          |
|-------------------------------|------------------|-----------------------------------|----------|
| ITEM                          | VOLTAGE          | DESCRIPTION                       | PART NO. |
| CB1                           | 120V-50/60Hz     | CKT BRKR, 10 AMP SINGLE POLE      | 60077901 |
|                               | 208-240V 50/60Hz | CKT BRKR, 5 AMP TWO POLE          | 60078502 |
| F2                            | ALL              | FUSE 0.2A 250V TIME DELAY CERAMIC | 60132701 |
| FH2                           | ALL              | FUSE HOLDER, IN LINE, .25 X 1.25  | PP10765  |
| K5                            | 120V-50/60Hz     | RELAY, 24VAC, 30A SPST            | PP11058  |
|                               | 208-240V 50/60HZ | RELAY, 24VAC, 30A DPST            | 60104701 |
| LS4                           | ALL              | SWITCH, PROXIMITY MAGNETIC        | B5305001 |
|                               | ALL              | SWITCH, ACTUATOR MAGNETIC         | PP10263  |
| M1 (HAIGHT)                   | 120V-50/60Hz     | MOTOR AND PUMP 1/3HP, 8GPM        | 60130801 |
|                               | 230V-50/60Hz     | MOTOR AND PUMP 1/3HP, 8GPM        | 60130802 |
|                               | 240V/50Hz        | MOTOR AND PUMP 1/3HP, 8GPM        | 60130808 |
| M1 (HAIGHT) 5GPM              | 208V-50/60Hz     | MOTOR AND PUMP 1/3HP, 8GPM        | 60130808 |
|                               | 120V-50/60Hz     | MOTOR AND PUMP 1/3HP, 5GPM        | 60130806 |
|                               | 230V-50/60Hz     | MOTOR AND PUMP 1/3HP, 5GPM        | 60130807 |
| M2 (VIKING)                   | 240V/50Hz        | MOTOR AND PUMP 1/3HP, 5GPM        | 60130810 |
|                               | 208V-50/60Hz     | MOTOR AND PUMP 1/3HP, 5GPM        | 60130810 |
|                               | 115V-50/60Hz     | MOTOR AND PUMP 1/3HP, 8GPM        | 60143501 |
| M2 (VIKING) 5GPM              | 230V-50/60Hz     | MOTOR AND PUMP 1/3HP, 8GPM        | 60143501 |
|                               | 208-240V/50/60Hz | MOTOR AND PUMP 1/3HP, 8GPM        | 60143503 |
|                               | 115V-50/60Hz     | MOTOR AND PUMP 1/3HP, 5GPM        | 60143502 |
| T3                            | 230V-50/60Hz     | MOTOR AND PUMP 1/3HP, 5GPM        | 60143504 |
|                               | 208-240V/50/60Hz | MOTOR AND PUMP 1/3HP, 5GPM        | 60143504 |
|                               | 120V-50/60Hz     | XFMR, 120/24VAC 5VA               | 60130301 |
| T3                            | 230V-50/60Hz     | XFMR, 240/24 VAC 5VA              | 60130302 |
|                               | 240V-50Hz        | XFMR, 240/24 VAC 5VA              | 60130302 |
|                               | 208V-50/60Hz     | XFMR, 208/24VAC 5VA               | 60130303 |

# Wiring Diagrams – Filter Motor 208-240V

## 208-240V FILTER PUMP OPTIONS

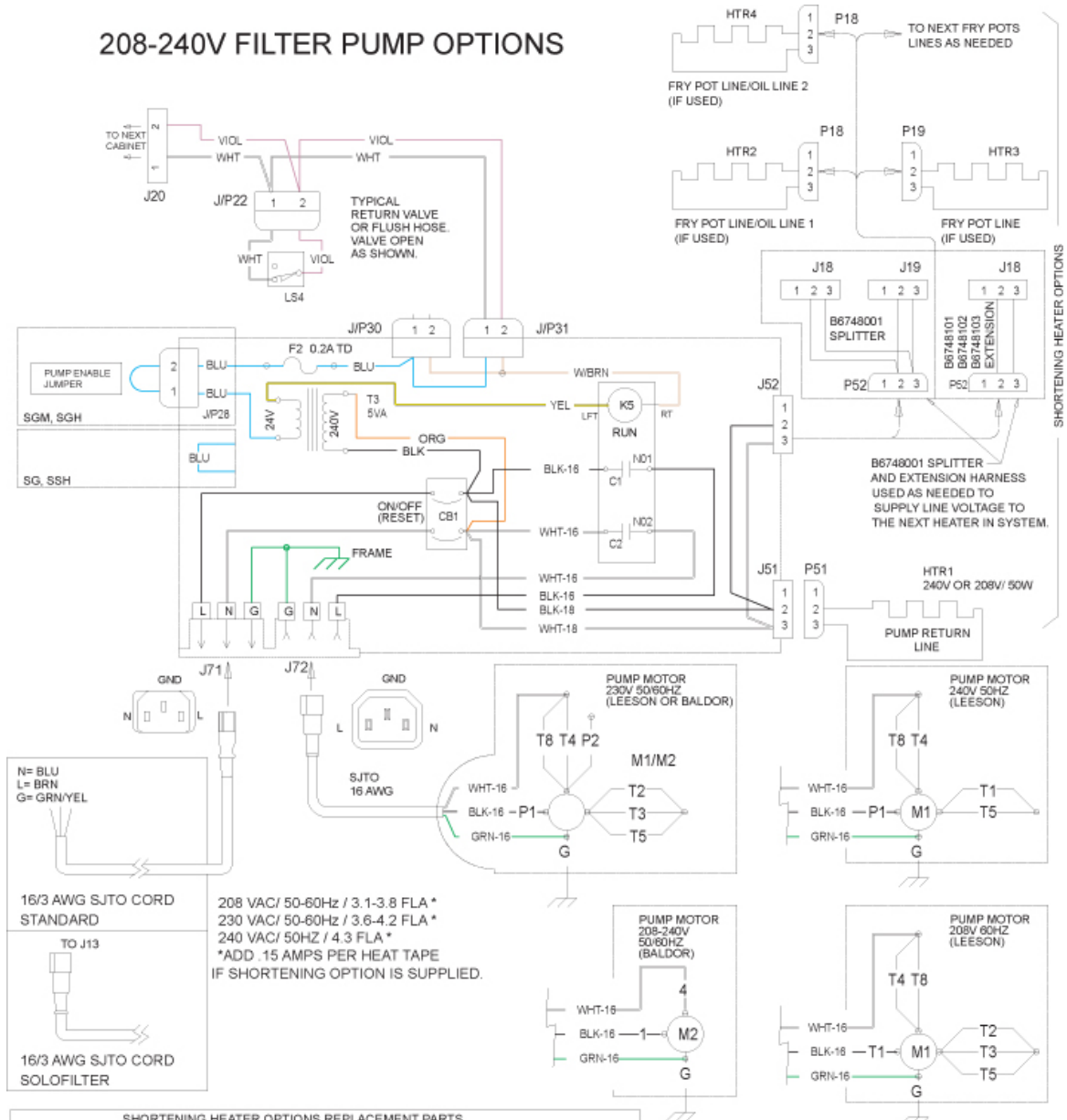

208 VAC/ 50-60Hz / 3.1-3.8 FLA \*  
 230 VAC/ 50-60Hz / 3.6-4.2 FLA \*  
 240 VAC/ 50HZ / 4.3 FLA \*  
 \*ADD .15 AMPS PER HEAT TAPE  
 IF SHORTENING OPTION IS SUPPLIED.

| SHORTENING HEATER OPTIONS REPLACEMENT PARTS         |                           |             |          |
|---|---------------------------|-------------|----------|
| ITEM  | DESCRIPTION               | VOLTAGE     | PART NO. |
| HTR1<br>PUMP RETURN                                 | HEATER TAPE 1/2X 72", 50W | 120-50/60Hz | 60133503 |
|   |                           | 230-50/60Hz | 60133504 |
|   |                           | 240/50Hz    | 60133507 |
|   |                           | 208-50/60Hz | 60133508 |
| HTR2,3<br>OIL HOSE<br>SG, SSH, SFSG<br>SGH, SGM1824 | HEATER TAPE 1/2X 33", 25W | 120-50/60Hz | 60133501 |
|   |                           | 230-50/60Hz | 60133502 |
|   |                           | 240/50Hz    | 60133507 |
|   |                           | 208-50/60Hz | 60133509 |
| HTR2,3<br>OIL HOSE<br>SGM24, SGM34                  | HEATER TAPE 1/2X 48", 33W | 120-50/60Hz | 60133505 |
|   |                           | 230-50/60Hz | 60133506 |
|   |                           | 240/50Hz    | 60133507 |
|   |                           | 208-50/60Hz | 60133509 |
| HTR3,4<br>FRYPOT LINES<br>SG18, SSH75<br>SSH60      | HEATER TAPE 1/2X 33", 25W | 120-50/60Hz | 60133501 |
|   |                           | 230-50/60Hz | 60133502 |
|   |                           | 240/50Hz    | 60133507 |
|   |                           | 208-50/60Hz | 60133510 |
| HTR3,4<br>FRYPOT LINES<br>SG14", SSH55"<br>SSH60W*  | HEATER TAPE 1/2X 24", 18W | 120-50/60Hz | 60133510 |
|   |                           | 230-50/60Hz | 60133511 |
|   |                           | 240/50Hz    | 60133512 |
|   |                           | 208-50/60Hz | 60133512 |

# Notes

# Notes

---