

REPLACEMENT PARTS FOR DIRECT-FIRED MAKEUP AIR HEATER

MODEL RDF



TABLE OF CONTENTS

REFERENCES.....	2
SAMPLE RATING PLATE AND KEY	2
SERIAL NUMBERS	3
ELECTRICAL COMPONENTS	4
BLOWER MOTOR, MOTOR CONTACTOR, AND STARTER CONTACTOR.....	11
GAS REGULATORS, GAS VALVES, AND GAS PRESSURE SWITCHES.....	22
MODULATING GAS CONTROL COMPONENTS	25
IGNITION SYSTEM COMPONENTS	26
BURNER COMPONENTS	29
DAMPER COMPONENTS	31
BLOWER- AND MOTOR-MOUNTING COMPONENTS	35
DRIVE COMPONENTS.....	37
SCREENED AIR INLET HOODS FOR OUTDOOR UNITS	50
OUTSIDE AIR FILTER RACK ASSEMBLIES FOR INDOOR UNITS.....	53
ROOF CURB COMPONENTS	54

IMPORTANT

1. Always include complete model and serial number so that any specification change can be considered for parts replacement. It can save time and expense.
2. In keeping with our policy of continuous product improvement, we reserve the right to alter any information shown here. Specifications are subject to change without notice.
3. We reserve the right to substitute functional replacements.
4. Order by kit or component Part Number (PN).

SERIAL NUMBERS

Serial number format changed in June of 2015. Use the following information to decode system serial numbers:

Decoding a System Serial Number for ALL Models *Before* JUN 2015

Serial No. Sample: BLJ 82 V1 N 00000 CA MV7
Elements of No.: 1 | 2 | 3 | 4 | 5 | 6 | 7

Key:

- 1 = Date of manufacture (refer to [Table 2](#))
- 2 = Type of pilot system (refer to *P-VALVES* manual listed in [Table 1](#))
- 3 = Type of gas valve (refer to *P-VALVES* manual listed in [Table 1](#))
- 4 = Type of gas (N = natural, L = propane)
- 5 = Consecutive number (identification only)
- 6 = Type of air control (CA = constant air volume, VA = variable air volume, RA = recirculation air)
- 7 = Type of Maxitrol gas control (MV7 = Maxitrol System 14, MV8 = Maxitrol System 14A, MVC = Maxitrol A200)

Decoding a System Serial Number for ALL Models *After* MAY 2015

Serial No. Sample: BOG 3060 00000
Elements Key No.: 1 | 2 | 3

Key:

- 1 = Date of manufacture (refer to [Table 2](#))
- 2 = Plant of manufacture (3060 = Mercer, 3062 = Monterrey)
- 3 = Consecutive number

Table 2. Serial Number Date Codes (Month and Year)												
Year	Month											
	JAN	FEB	MAR	APR	MAY	JUN	JUL	AUG	SEP	OCT	NOV	DEC
2003	BCA	BCB	BCC	BCD	BCE	BCF	BCG	BCH	BCI	BCJ	BCK	BCL
2004	BDA	BDB	BDC	BDD	BDE	BDF	BDG	BDH	BDI	BDJ	BDK	BDL
2005	BEA	BEB	BEC	BED	BEE	BEF	BEG	BEH	BEI	BEJ	BEK	BEL
2006	BFA	BFB	BFC	BFD	BFE	BFF	BFG	BFH	BFI	BFJ	BFK	BFL
2007	BGA	BGB	BGC	BGD	BGE	BGF	BGG	BGH	BGI	BGJ	BGK	BGL
2008	BHA	BHB	BHC	BHD	BHE	BHF	BHG	BHH	BHI	BHJ	BHK	BHL
2009	BIA	BIB	BIC	BID	BIE	BIF	BIG	BIH	BII	BIJ	BIK	BIL
2010	BJA	BJB	BJC	BJD	BJE	BJF	BJG	BJH	BJI	BJJ	BJK	BJL
2011	BKA	BKB	BKC	BKD	BKE	BKF	BKG	BKH	BKI	BKJ	BKK	BKL
2012	BLA	BLB	BLC	BLD	BLE	BLF	BLG	BLH	BLI	BLJ	BLK	BLL
2013	BMA	BMB	BMC	BMD	BME	BMF	BMG	BMH	BMI	BMJ	BMK	BML
2014	BNA	BNB	BNC	BND	BNE	BNF	BNG	BNH	BNI	BNJ	BNK	BNL
2015	BOA	BOB	BOC	BOD	BOE	BOF	BOG	BOH	BOI	BOJ	BOK	BOL
2016	BPA	BPB	BPC	BPD	BPE	BPF	BPG	BPH	BPI	BPJ	BPK	BPL
2017	BQA	BQB	BQC	BQD	BQE	BQF	BQG	BQH	BQI	BQJ	BQK	BQL
2018	BRA	BRB	BRC	BRD	BRE	BRF	BRG	BRH	BRI	BRJ	BRK	BRL
2019	BSA	BSB	BSC	BSD	BSE	BSF	BSG	BSH	BSI	BSJ	BSK	BSL
2020	BTA	BTB	BTC	BDT	BTE	BTF	BTG	BTH	BTI	BTJ	BTk	BTL
2021	BUA	BUB	BUC	BUD	BUE	BUF	BUG	BUH	BUI	BUJ	BUK	BUL
2022	BVA	BVB	BVC	BVD	BVE	BVF	BVG	BVH	BVI	BVJ	BVK	BVL
2023	BWA	BWB	BWC	BWD	BWE	BWF	BWG	BWH	BWI	BWJ	BWK	BWL
2024	BXA	BXB	BXC	BXD	BXE	BXF	BXG	BXH	BXI	BXJ	BXK	BXL
2025	BYA	BYB	BYC	BYD	BYE	BYF	BYG	BYH	BYI	BYJ	BYK	BYL

ELECTRICAL COMPONENTS

NOTE:

- **Figure 1** shows the approximate locations of controls on model RDF series 3 units. Manufacture of series 3 units began in SEP 2003. Model RDF units manufactured prior to series 3 have similar controls but the control locations are different. Because this product has experienced ongoing development, always provide the complete model and serial number when inquiring about or ordering replacement parts.
- **Table 3, Table 4, Table 5, Table 6, and Table 7** list electrical components. **Figure 2 and Figure 3** show individual electrical components.

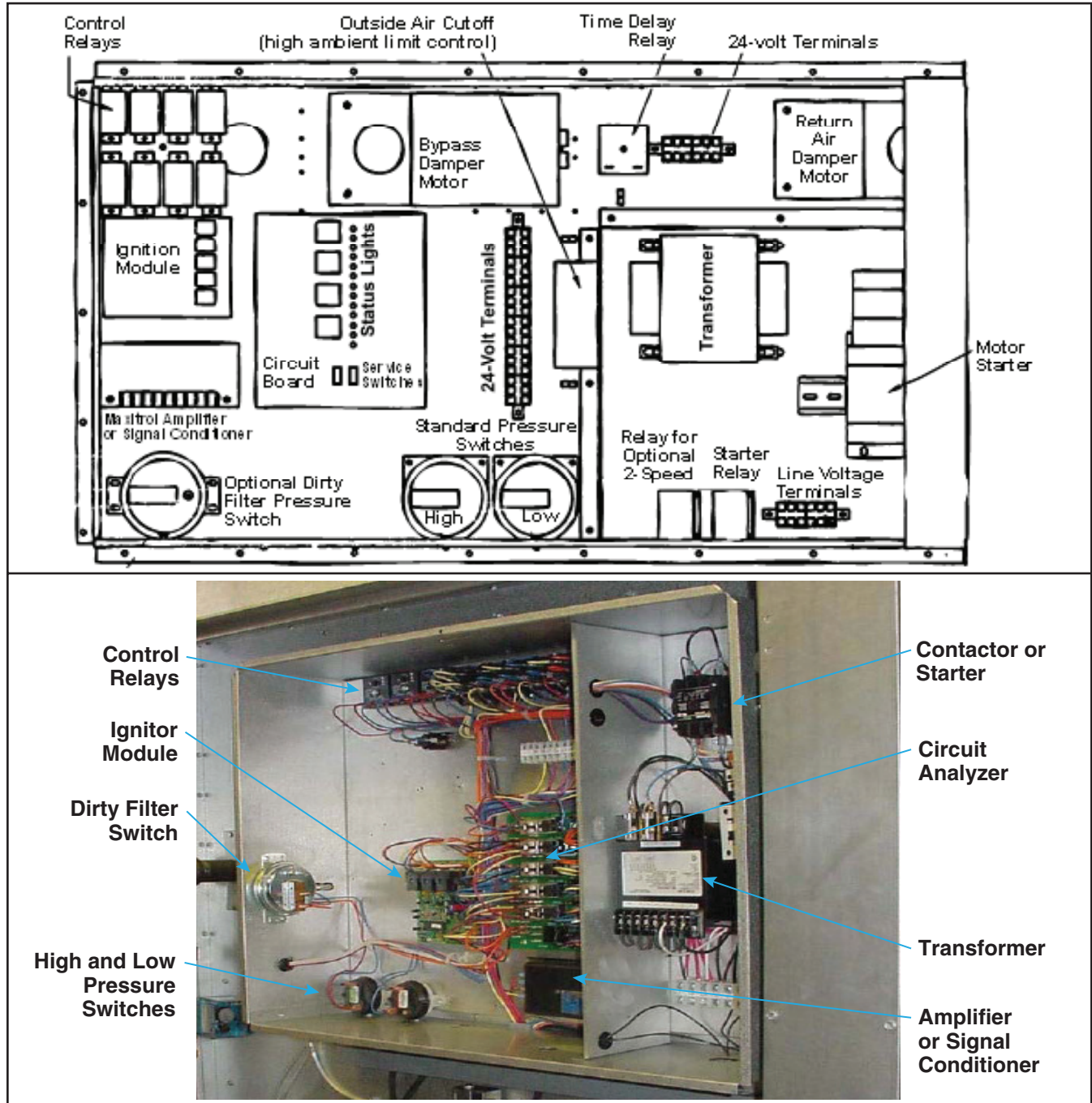

Figure 1. Electrical Control Compartment Typical Component Locations

Table 3. Electrical Components

Item No.	Component	Description	PN	Location
1	Relay	SPST or SPDT, 24V coil (units manufactured <i>after</i> AUG 2011)	211411	Control compartment
	Socket base	Relay	211415	
	Relay replacement kit	Replaces PNs 14747, 18549, 98118, and 103317 (units manufactured <i>before</i> SEP 2011)	263527	
	Relay	SPST or SPDT, 120V coil (units manufactured <i>after</i> AUG 2011)	211414	
	Socket base	Relay	211415	
	Relay replacement kit	Replaces PNs 103318 and 103319 (units manufactured <i>before</i> SEP 2011)	263530	
2	Time delay relay	Low fire, 24V coil, Thermodisc #F12S20, style 305139 (units manufactured <i>before</i> MAR 1996)	89254	Blower discharge
3		For freezestat bypass, T&B Agastst #VTM1ULA	89661	
4		Prepurge, 24V coil, Thermodisc #12S20	52887	
5	Relay	24V coil, Essex #91-102006-1300	110656	
6	Limit switch	Manual reset, Thermodisc 330545, L150	82610	Blower discharge
7		Automatic reset, Thermodisc #60T11-312616, L135	86979	
8	Limit control/freezestat	High ambient/outside air cutoff, adjustable, J/C #A19AAF-12C (replaces PN 16108)	126170	Control compartment
8A	Clamp	Grommet	131993	Control compartment
8B		Cable	132065	
9	Flame safety limit	ECO, opens at 306°F, Thermodisc #G4AP0200152C	82414	Gas train compartment
10	Firestat	Honeywell #L4029E1029, 200°F	42782	Blower discharge
11	Spark generator	120V, Honeywell #Q624A1014 (units manufactured <i>before</i> MAR 1996)	86974	Control compartment
12	Pressure switch	Low air pressure, 0.25 IN WC setting (units manufactured <i>after</i> DEC 2002)	203932	
12A	Pressure switch kit	Low air pressure, terminals, 0.20-inch switch (units manufactured <i>before</i> JAN 2003)	193806	
13	Pressure switch	High air pressure, 0.75 IN WC setting (units manufactured <i>after</i> DEC 2002)	203933	
13A	Pressure switch kit	High air pressure, terminals, 0.90-inch switch (units manufactured <i>before</i> JAN 2003)	193807	
14	Pressure switch	Air pressure, 0.65 IN WC setting (option AR19, AR20, AR22, or AR23)	207177	
14A	Pressure switch kit	Air pressure, wires, terminals, 0.65-inch switch (option AR19, AR20, AR22, or AR23) (replaces PN 87250)	193809	
15	Pressure switch	Air pressure, 0.50 IN WC setting (option AR19, AR20, AR22, or AR23)	207179	
15A	Pressure switch kit	Air pressure, wires, terminals, 0.50 IN WC switch (option AR19, AR20, AR22, or AR23) (replaces PN 87249)	193808	
16	Tee	Plastic, for air pressure tubing, 3/16 × 1/16 ID	87482	
17	Tubing (not shown)	Plastic, yellow, for air pressure switch, 3/16 OD × 14 inches	122855	
		Plastic, clear, for air pressure switch, 3/16 OD × 3 feet	102401	
18	Bushing and screen	Insect screen, for sensing probes (not shown)	96794	—
19	Contactors	HCC-2XQ01AA, 24V (used with option BM80 or BM81 manifold)	203935	Control compartment
20	Analyzer board	Diagnostic circuit (standard beginning with series 3, option BS2 prior to series 3)	151263	
20A	Replacement bulb	For circuit analyzer board, series 3	125189	
		For circuit analyzer board (option BS2 <i>before</i> series 3)	101889	
20B	Replacement relay	For circuit analyzer board, SKMP-2C-24AC	151271	
21	Terminal block*	#KT3	144972	
21A	Adapter	Terminal block	144973	
22	Outlet receptacle	Convenience, Hubbell #GF5362 (separate electrical supply)	96912	
23	Pressure switch	Dirty filter, Tri-Delta #AP4434, set at 0.3 IN WC	105507	
23A	Tubing (not shown)	Plastic, clear, for dirty filter pressure switch, 3/16 OD × 112 inches	179302	
24	Fuse	Refer to Table 4		
24A	Fuseholder	Buss model HTB-481 (units manufactured <i>after</i> JUL 2012)	60241	Control compartment
25	Transformer	Refer to Table 5		
26	System switch	DPDT, Winter/Off/Summer, Cutler Hammer 7561K6	101900	Space (console)
27	Service switch	SPDT, Cutler Hammer 7505K6	101901	Control compartment
28	Null pressure switch	0.01–0.20 IN WC, Dwyer #1640-0 (options AR20 and AR23)	88052	Heated space
29	Potentiometer*	Honeywell 112894FA (options AR19 and AR22)	16110	Space

*Also located on remote console.

ELECTRICAL COMPONENTS—CONTINUED

Table 3. Electrical Components—Continued

Item No.	Component	Description	PN	Location
30	Pressure sensor	Photohelic, 3000-00-N24VAC (options AR36 and AR37)	158893	Remote
30A	Sampling tube	For pressure sensor (not shown)	159714	
31	Remote console	Refer to Table 6		
32	Disconnect switch	Refer to Table 7		

Table 4. Fuses (Item 24)

Description	PN
2.5A, #3210 (spark ignition)	61542
Bussman FRN-R15, 230/1	14667
Bussman FRN-R30, 208/230/3	31892
Bussman FRN-R10, 208/3	89265
Bussman FRN-R7, 230/3	16207
Bussman FRN-R25, 208/3	45054
Bussman FRN-R60	31895
Bussman FRN-R50	87957
Bussman FRN-R90	89931
Bussman FRN-R150	91077
Bussman FRN-R175	91595
Bussman FRS-R3.5, 460/3	89266
Bussman FRS-R8, 460/3	89268
Bussman FRS-R5, 460/3	89267
Bussman FRS-R15, 460/3	87638
Bussman FRS25	31891
Bussman FRS-R40	89936
8A, Fusetron 3AG-8 (hot surface ignition)	38636
5A, Fusetron MDL 3AG	90335

Table 5. Transformers (Item 25)

Volts Out	Volts In	VA	Description	PN
24	120	40	Basler #BE141650-WAA (used with spark ignition, two (2) required to replace PN 61806)	103055
		500	Hevi-Duty T500E	159842
	120/240	250	TB1-81146 (used with hot surface ignition)	38634
	208	200	Hevi-Duty #2223034T00	39094
	208/230/460	500	Hevi-Duty T500CK	159843
	208/240	40	Basler #BE21539001 (two (2) required to replace PN 61807)	103497
	208/240/480/575	200	C0200KAT or Hevi-Duty #2123105t00	39095
110	460	40	Basler #BE23975001 (two (2) required to replace PN 61808)	103498
		500	Hevi-Duty #2227003T00	86998
	208/230/460/575	275	C0275KAU E5E	105202
120	230/460	500	Hevi-Duty #2227001T00	86997
	208/240/480/575	275	Eaton #C0275KAU	105202

NOTE:

- Remote console features depend on the option selected.
- All available options provide a control switch.
- The temperature sensor/selector is available with gas control options AG30, AG31, AG32, AG33, AG47, AG48, and AG51.
- The potentiometer is available with air control options AR19 and AR22.
- Refer to the custom wiring diagram for control wiring.
- If the remote console is to be recess-mounted, subtract 7/8 inch from the length and height listed in [Table 6](#) when mounting.

Table 6. Remote Console (Item 31) Technical Data and Components					
Available Features			Control Box Assembly Dimensions		
Indicator Lights	Temperature Sensor/Selector?	Potentiometer?	Length	Height*	Depth
			Inches		
Blower On, Burner On, Safety Lockout	Yes	No	10-13/16	7-3/8	2-5/8
	No	Yes			
	No	No			
Blower On, Burner On, Safety Lockout, Dirty Filter Indicator	Yes	Yes	15-13/16		
	Yes	Yes	15-13/16		
	Yes	No			
	No	Yes			
	No	No			
Item No.	Component	Description			PN
31A	Box	Remote console, 10-9/16 × 7-1/4 × 2-5/8 inches			107010
		Remote console, 15-9/16 × 7-1/4 × 2-5/8 inches			107011
31B	Mounting ring	For 10-13/16-inch-long box			107014
		For 15-13/16-inch-long box			107015
31C	Indicator light	Red lens, Solico 5TD1L-R-B5			101889
31CC	Bushing	For installing indicator light on old-style console			106747
31D	Control switch	DPDT, Cutler Hammer #7561K6			101900
31E	Potentiometer	Honeywell 112894FA			16110
31F	Temperature selector	Options AG30 and AG31			86988
					101165
		Option AG32			87101
		Option AG33			86990
		Option AG47			204455
Options AG48 and AG51			204451		

*Changed OCT 2001.

ELECTRICAL COMPONENTS—CONTINUED

Table 7. Disconnect Switches (Item 32)								
Application	Amps	Voltage	Installation Location					
			US		Canada			
			Non-Fusible	Fusible	Non-Fusible	Fusible		
			PN (Option)					
Indoor	30	240	40267 (CP1)	40268 (CP2)	—			
		600	50365 (CP3)	50366 (CP4)	208053 (CP58)	208045 (CP41)		
	60	240	161462 (CP21)	89932* (CP17)	—			
		600	161464 (CP23)	90974* (CP20)	208055 (CP60)	208047 (CP43)		
	100	240	161463 (CP22)	90973* (CP18)	—			
		600	164330 (CP24)	155010* (CP36)	208057 (CP62)	208049 (CP45)		
	200	240	155005 (CP26)	91076* (CP19)	—			
		600	155009 (CP35)	155011* (CP37)	208059 (CP64)	208051 (CP47)		
	Outdoor (raintight)	30	240	40269 (CP5)	87147 (CP6)	—		
			600	50367 (CP7)	50368 (CP8)	208054 (CP59)	208046 (CP42)	
60		240	161469 (CP30)	89932 (CP17)	—			
		600	155012 (CP38)	90974 (CP20)	208056 (CP61)	208048 (CP44)		
100		240	162834 (CP31)	90973 (CP18)	—			
		600	155013 (CP39)	155010 (CP36)	208058 (CP63)	208050 (CP46)		
200		240	155007 (CP32)	91076 (CP19)	—			
		600	155014 (CP40)	155011 (CP37)	208060 (CP65)	208052 (CP48)		
Application		Motor**		Amps	Installation Location			
		Voltage/Phase	Horsepower		US		Canada	
	Non-Fusible				Fusible	Non-Fusible	Fusible	
	Option							
Indoor	115/1	1/4 to 1-1/2	30	CP1	CP2	CP60	CP43	
		2 to 3	60	CP21	CP27	CP60	CP43	
	208/1 and 230/1	1/4 to 3	30	CP1	CP2	CP58	CP41	
		5 to 10	60	CP21	CP27	CP60	CP43	
	208/3 and 230/3	1/4 to 5	30	CP1	CP2	CP58	CP41	
		7-1/2 to 15	60	CP21	CP27	CP60	CP43	
		20 to 25	100	CP22	CP28	CP62	CP45	
	460/3 and 575/3	30	200	CP26	CP29	CP64	CP47	
		1/4 to 15	30	CP3	CP4	CP58	CP41	
	Outdoor (raintight)	115/1	20 to 30	60	CP23	CP33	CP60	CP43
1/4 to 1-1/2			30	CP5	CP6	CP59	CP42	
208/1 and 230/1		2 to 3	60	CP30	CP17	CP61	CP44	
		1/4 to 3	30	CP5	CP6	CP59	CP42	
208/3 and 230/3		5 to 10	60	CP30	CP17	CP61	CP44	
		1/4 to 5	30	CP5	CP6	CP59	CP42	
460/3 and 575/3		7-1/2 to 15	60	CP30	CP17	CP61	CP44	
		20 to 25	100	CP31	CP18	CP63	CP46	
208/3 and 230/3		30	200	CP32	CP19	CP65	CP48	
		1/4 to 15	30	CP7	CP8	CP59	CP42	
460/3 and 575/3	20 to 30	60	CP38	CP20	CP61	CP44		
	1/4 to 15	30	CP7	CP8	CP59	CP42		

*Application uses an outdoor switch.

**Motor voltage varies in accordance with model and unit size.















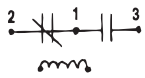

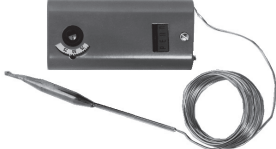





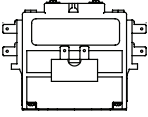
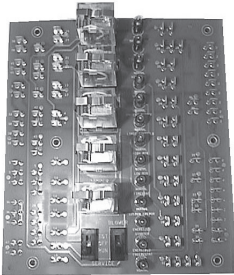





Item 1: Relay and Socket Base 	Item 2: Time Delay Relay 	Item 3: Time Delay Relay (Freezestat) 	Item 4 - Prepurge Time Delay Relay 
Item 5: Relay  	Item 6: Limit Switch, Manual Reset 	Item 7: Limit Switch, Automatic Reset 	
Item 8: Limit Control/Freezestat 	Item 9: Flame Safety Limit 	Item 10: Firestat 	
Item 11: Spark Generator 	Item 12: Low Air Pressure Switch and Item 13: High Air Pressure Switch and Items 14 and 15: Air Pressure Switch 	Item 16: Tee 	
Item 19: Contactor 	Item 20: Analyzer Board 	Item 21: Terminal Block and Item 21A: Terminal Block Adapter  	
Item 22: Convenience Outlet Receptacle 	Item 23: Dirty Filter Pressure Switch 	Item 24: Fuse and Item 24A: Fuseholder  	
Item 25: Transformer   <p>40VA 200-500VA</p>	Item 26: System Switch  	Item 27: Service Switch  	
Item 28: Potentiometer 	Item 29: Null Pressure Switch 	Item 30: Photohelic Pressure Sensor 	

Figure 2. Individual Electrical Components—Items 1 Through 30 (Refer to [Table 3](#))

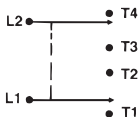
ELECTRICAL COMPONENTS—CONTINUED

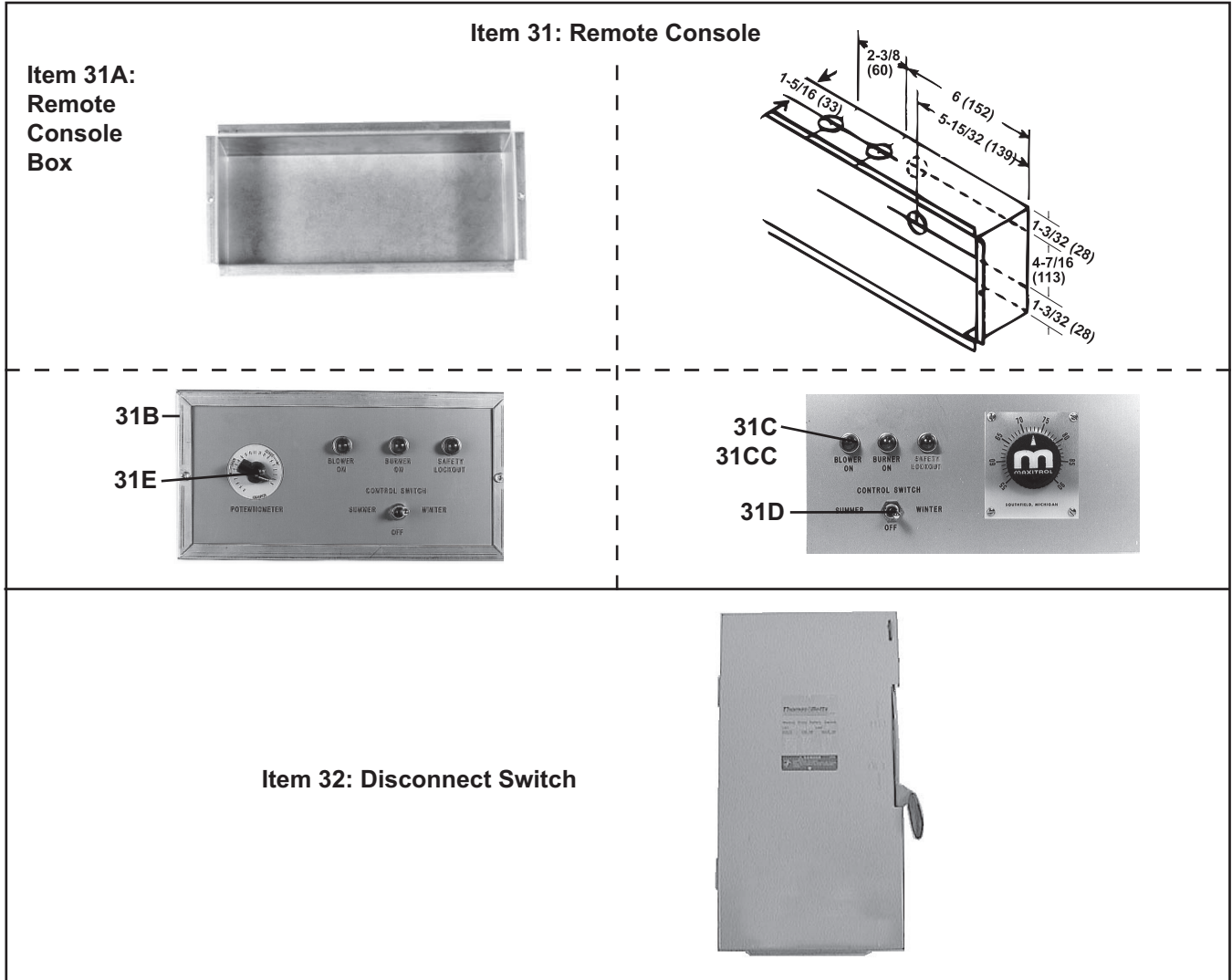

BLOWER MOTOR, MOTOR CONTACTOR, AND STARTER CONTACTOR

Units Manufactured *After* AUG 2003

NOTE:

- The motor contactor and starter contactor/overload are shown in [Figure 4](#).
 - Replacement motors are listed by type and horsepower for open-type motors, TEFC-type (totally-enclosed fan-cooled) motors, and EE-type (premium-efficiency) motors. Highlighted motors in [Table 8](#), [Table 9](#), and [Table 10](#) do not have internal overload protection and must be used with the motor starter and overload listed.
 - For motors with internal overloads, the standard motor contactor (see [Figure 4](#)) is manufacturer's model number HCC-3XQ01CY (PN [216386](#), option AN2).
 - Units with two-speed motors are equipped with IEC two-speed starter contactors (with 24V coils) and overloads (option AN10). When ordering a replacement IEC starter (refer to [Table 11](#)) or overload, check the manufacturer's number on both parts. If the number is different than that listed in [Table 8](#), [Table 9](#), or [Table 10](#), both components must be replaced.
 - Motor contactors and starters (with overload) are located in the electrical compartment.
 - Replacement coils for units with IEC starters are listed in [Table 12](#).
-

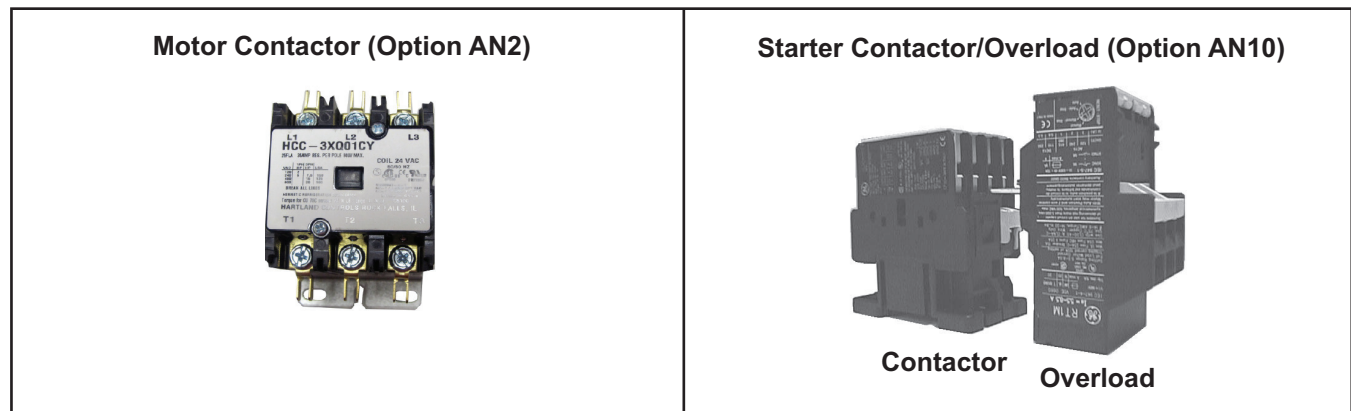

Figure 4. Motor Contactor and Starter Contactor/Overload

BLOWER MOTOR, MOTOR CONTACTOR, AND STARTER CONTACTOR—CONTINUED

Units Manufactured After AUG 2003—Continued

**Table 8. Open-Type Blower Motors with Starters/Overloads
(Units Manufactured After AUG 2003)**

HP	Motor									Starter (Option AN10)					
	MFR's Model	Full Load Amps (FLA)	Shaft Size (IN)	Voltage/Phase	Frame Size	SF*	PF*	EFF* (%)	PN	Starter Contactor		Starter Overload			
										MFR's Model	PN	GE Model	Min Amps	Max Amps	PN
1/2	AO-BF2054	8.8	5/8	120/1	56Z	1.2	—	—	102627	CL00A310T-1	151275	RTA1-N	8.0	12.0	151193
	AO-BF2054	5.1	5/8	208/1	56Z	1.2	—	—	102627	CL00A310T-1	151275	RTA1-L	4.0	6.3	151191
	AO-BF2054	4.4	5/8	240/1	56Z	1.2	—	—	102627	CL00A310T-1	151275	RTA1-L	4.0	6.3	151191
	AO-H880	2.5	5/8	208/3	LA56	1.3	—	—	159183	CL00A310T-1	151275	RTA1-J	1.8	2.7	151189
	AO-H880	3.0	5/8	240/3	LA56	1.3	—	—	159183	CL00A310T-1	151275	RTA1-K	2.5	4.1	151190
	AO-H880	1.5	5/8	480/3	LA56	1.3	—	—	159183	CL00A310T-1	151275	RTA1-H	1.3	1.9	151188
	AOS-H991	0.9	5/8	575/3	H56	1.3	—	—	202089	CL00A310T-1	151275	RTA1-F	0.7	1.1	151186
3/4	AO-312P629	11.0	5/8	120/1	B56	1.3	—	—	93548	CL01A310T-1	151276	RTA1-P	10.0	16.0	151194
	AO-312P629	6.3	5/8	208/1	B56	1.3	—	—	93548	CL00A310T-1	151275	RTA1-M	5.5	8.5	151192
	AO-312P629	5.5	5/8	240/1	B56	1.3	—	—	93548	CL00A310T-1	151275	RTA1-L	4.0	6.3	151191
	AO-312P696	2.9	5/8	208/3	D56	1.3	—	—	36951	CL00A310T-1	151275	RTA1-K	2.5	4.1	151190
	AO-312P696	2.6	5/8	240/3	D56	1.3	—	—	36951	CL00A310T-1	151275	RTA1-K	2.5	4.1	151190
	AO-312P696	1.3	5/8	480/3	D56	1.3	—	—	36951	CL00A310T-1	151275	RTA1-G	1.0	1.5	151187
	AOS - H992	1.0	5/8	575/3	H56	1.3	—	—	202090	CL00A310T-1	151275	RTA1-F	0.7	1.1	151186
1	AO-C523	13.0	5/8	120/1	H56	1.3	—	—	13685	CL01A310T-1	151276	RTA1-P	10.0	16.0	151194
	AO-C523	7.5	5/8	208/1	H56	1.3	—	—	13685	CL00A310T-1	151275	RTA1-M	5.5	8.5	151192
	AO-C523	6.5	5/8	240/1	H56	1.3	—	—	13685	CL00A310T-1	151275	RTA1-M	5.5	8.5	151192
	AO-H882	3.7	5/8	208/3	F56	1.2	—	79	36580	CL00A310T-1	151275	RTA1-K	2.5	4.1	151190
	AO-H882	3.2	5/8	240/3	F56	1.2	—	79	36580	CL00A310T-1	151275	RTA1-K	2.5	4.1	151190
	AO-H882	1.6	5/8	480/3	F56	1.2	—	79	36580	CL00A310T-1	151275	RTA1-H	1.3	1.9	151188
	AO-E1006	1.1	7/8	575/3	N143T	1.2	—	82.5	158175	CL00A310T-1	151275	RTA1-G	1.0	1.5	151187
1.5	AO-C621	15.0	5/8	120/1	56	1.2	86.4	77.2	194202	CL01A310T-1	151276	RTA1-P	10.0	16.0	151194
	AO-C621	7.8	5/8	208/1	56	1.2	86.4	77.2	194202	CL00A310T-1	151275	RTA1-M	5.5	8.5	151192
	AO-C621	7.5	5/8	240/1	56	1.2	86.4	77.2	194202	CL00A310T-1	151275	RTA1-M	5.5	8.5	151192
	AO-H884	5.6	5/8	208/3	UA56	1.2	66.4	78.6	115859	CL00A310T-1	151275	RTA1-L	4.0	6.3	151191
	AO-H884	5.0	5/8	240/3	UA56	1.2	66.4	78.6	115859	CL00A310T-1	151275	RTA1-L	4.0	6.3	151191
	AO-H884	2.8	5/8	480/3	UA56	1.2	66.4	78.6	115859	CL00A310T-1	151275	RTA1-K	2.5	4.1	151190
	AO-E1007	1.6	7/8	575/3	R145T	1.2	85.3	84.0	158162	CL00A310T-1	151275	RTA1-H	1.3	1.9	151188
2	AO-RB1204A	24.6	5/8	120/1	56H	—	—	—	202581	CL04A310M-1	151279	RTA1-U	21.0	26.0	151198
	AO-RB1204A	12.3	5/8	208/1	56H	—	—	—	202581	CL01A310T-1	151276	RTA1-P	10.0	16.0	151194
	AO-RB1204A	12.3	5/8	240/1	56H	—	—	—	202581	CL01A310T-1	151276	RTA1-P	10.0	16.0	151194
	AO-H886	7.0	7/8	208/3	56HZ	1.2	67	79	159327	CL00A310T-1	151275	RTA1-M	5.5	8.5	151192
	AO-H886	6.6	7/8	240/3	56HZ	1.2	67	79	159327	CL00A310T-1	151275	RTA1-M	5.5	8.5	151192
	AO-H886	3.5	7/8	480/3	56HZ	1.2	67	79	159327	CL00A310T-1	151275	RTA1-K	2.5	4.1	151190
	AO-E1008	2.1	7/8	575/3	P145T	1.2	86	84.0	158176	CL00A310T-1	151275	RTA1-J	1.8	2.7	151189
3	AO-B735	13.7	5/8	208/1	L56	1.2	—	—	111560	CL01A310T-1	151276	RTA1-P	10.0	16.0	151194
	AO-B735	12.4	5/8	230/1	L56	1.2	—	—	111560	CL01A310T-1	151276	RTA1-P	10.0	16.0	151194
	AO-H845	9.0	7/8	208/3	P56HZ	1.2	—	—	159185	CL00A310T-1	151275	RTA1-N	8.0	12.0	151193
	AO-H845	8.6	7/8	240/3	P56HZ	1.2	—	—	159185	CL00A310T-1	151275	RTA1-N	8.0	12.0	151193
	AO-H845	4.3	7/8	480/3	P56HZ	1.2	—	—	159185	CL00A310T-1	151275	RTA1-L	4.0	6.3	151191
	AO-H954	3.6	7/8	575/3	N56HZ	1.2	80.3	83.8	120019	CL00A310T-1	151275	RTA1-K	2.5	4.1	151190
5	AO-V211	28.3	1-1/8	208/1	L184T	—	—	—	111562	CL04A310M-1	151279	RTA1-V	25.0	32.0	151199
	AO-V211	25.6	1-1/8	240/1	L184T	—	—	—	111562	CL04A310M-1	151279	RTA1-V	25.0	32.0	151199
	AO-196033	13.4	7/8	208/3	Y56HZ	1.2	87.2	85	113371	CL01A310T-1	151276	RTA1-P	10.0	16.0	151194
	AO-196033	13.2	7/8	240/3	Y56HZ	1.2	87.2	85	113371	CL01A310T-1	151276	RTA1-P	10.0	16.0	151194
	AO-196033	6.6	7/8	480/3	Y56HZ	1.2	87.2	85	113371	CL00A310T-1	151275	RTA1-M	5.5	8.5	151192
	AO-H956	5.4	7/8	575/3	Y56HZ	1.2	85.9	85.3	120020	CL00A310T-1	151275	RTA1-L	4.0	6.3	151191

*SF = service factor, PF = power factor, and EFF = efficiency.

**Table 8. Open-Type Blower Motors with Starters/Overloads
(Units Manufactured After AUG 2003)—Continued**

HP	Motor									Starter (Option AN10)					
	MFR's Model	Full Load Amps (FLA)	Shaft Size (IN)	Voltage/Phase	Frame Size	SF*	PF*	EFF* (%)	PN	Starter Contactor		Starter Overload			
										MFR's Model	PN	GE Model	Min Amps	Max Amps	PN
7.5	AO-V305	35.4	1-3/8	208/1	S215T	—	—	—	105828	CL06A311M-1	203687	RTA2-E	30.0	43.0	151206
	AO-V305	32.0	1-3/8	230/1	S215T	—	—	—	105828	CL06A311M-1	203687	RTA2-E	30.0	43.0	151206
	AO-E300	22.5	1-3/8	208/3	213T	—	—	—	105855	CL04A310M-1	151279	RTA1-U	21.0	26.0	151198
	AO-E300	19.4	1-3/8	240/3	213T	—	—	—	105855	CL25A310T-1	1024071	RTA1-T	17.5	22.0	1024078
	AO-E300	9.7	1-3/8	480/3	213T	—	—	—	105855	CL00A310T-1	151275	RTA1-N	8.0	12.0	151193
	AO-E324	7.8	1-3/8	575/3	S213T	—	—	—	158164	CL00A310T-1	151275	RTA1-M	5.5	8.5	151192
10	AO-V303	42.0	1-3/8	208/1	S215T	—	—	—	105830	CL06A311M-1	203687	RTA2-E	30.0	43.0	151206
	AO-V303	38.0	1-3/8	230/1	S215T	—	—	—	105830	CL06A311M-1	203687	RTA2-E	30.0	43.0	151206
	AO-E301	31.0	1-3/8	208/3	215T	—	—	—	105858	CL04A310M-1	151279	RTA1-V	25.0	32.0	151199
	AO-E301	26.0	1-3/8	240/3	215T	—	—	—	105858	CL04A310M-1	151279	RTA1-V	25.0	32.0	151199
	AO-E301	13.0	1-3/8	480/3	215T	—	—	—	105858	CL01A310T-1	151276	RTA1-P	10.0	16.0	151194
	AO-E325	10.4	1-3/8	575/3	S215T	—	—	—	158163	CL01A310T-1	151276	RTA1-P	10.0	16.0	151194
15	B-FM2513T-8-F2	43.1	1-5/8	208/3	254T	—	—	—	142287	CL06A311M-1	203687	RTA2-G	42.0	55.0	151202
	BALD-FM2523T	39.0	1-5/8	240/3	254T	—	—	—	142288	CL06A311M-1	203687	RTA2-E	30.0	43.0	151206
	BALD-FM2523T	19.5	1-5/8	480/3	254T	—	—	—	142288	CL25A310T-1	1024071	RTA1-T	17.5	22.0	1024078
	B-EFM2513T-5-F2	16.0	1-5/8	575/3	254T	—	—	—	142289	CL02A310T-1	151277	RTA1-S	14.5	18.0	151196
20	B-FM2515T-8-F2	58.7	1-5/8	208/3	256T	1.2	80	88.5	142295	CL07A311M-1	203793	RTA2-H	54.0	65.0	151203
	BAL-FM2515T-F2	53.0	1-5/8	240/3	256T	1.2	81	88.5	142296	CL07A311M-1	203793	RTA2-G	42.0	55.0	151202
	BAL-FM2515T-F2	26.5	1-5/8	480/3	256T	1.2	81	88.5	142296	CL04A310M-1	151279	RTA1-V	25.0	32.0	151199
	B-FM2515T-5-F2	21.2	1-5/8	575/3	256T	1.2	80	88.5	142297	CL25A310T-1	1024071	RTA1-T	17.5	22.0	1024078
25	E545-F2	69.8	1-7/8	208/3	S284T	1.15	84.1	91.7	159021	CL09A311M-1	203794	RTA2-j	64.0	82.0	151204
	E546-F2	60.6	1-7/8	240/3	S284T	1.15	84.1	91.7	159022	CL07A311M-1	203793	RTA2-H	54.0	65.0	151203
	E546-F2	30.3	1-7/8	480/3	S284T	1.15	84.1	91.7	159022	CL04A310M-1	151279	RTA1-V	25.0	32.0	151199
	E594-F2	24.3	1-7/8	575/3	S284T	1.15	84.1	91.7	159023	CL04A310M-1	151279	RTA1-U	21.0	26.0	151198
30	E547-F2	78.0	1-7/8	208/3	S286T	1.15	81	92.4	159024	CL09A311M-1	203794	RT2-J	64.0	82.0	151204
	E548-F2	75.0	1-7/8	240/3	S286T	1.15	81	92.4	159025	CL09A311M-1	203794	RT2-J	64.0	82.0	151204
	E548-F2	37.5	1-7/8	480/3	S286T	1.15	81	92.4	159025	CL06A311M-1	203687	RTA2-E	30.0	43.0	151206
	E595-F2	30.0	1-7/8	575/3	S286T	1.15	81	92.4	159026	CL04A310M-1	151279	RTA1-V	25.0	32.0	151199

*SF = service factor, PF = power factor, and EFF = efficiency.

**Table 9. TEFC-Type Blower Motors with Starters/Overloads
(Units Manufactured After AUG 2003)**

HP	Motor									Starter (Option AN10)					
	MFR's Model	Full Load Amps (FLA)	Shaft Size (IN)	Voltage/Phase	Frame Size	SF*	PF*	EFF* (%)	PN	Starter Contactor		Starter Overload			
										MFR's Model	PN	GE Model	Min Amps	Max Amps	PN
1/2	AO-C613	7.2	5/8	120/1	J56	—	—	—	159184	CL00A310T-1	151275	RTA1-M	5.5	8.5	151192
	AO-C613	3.5	5/8	208/1	J56	—	—	—	159184	CL00A310T-1	151275	RTA1-K	2.5	4.1	151190
	AO-C613	3.6	5/8	240/1	J56	—	—	—	159184	CL00A310T-1	151275	RTA1-K	2.5	4.1	151190
	AO-H274	2.3	5/8	208/3	H56	1	59.5	74.8	16077	CL00A310T-1	151275	RTA1-J	1.8	2.7	151189
	AO-H274	2.0	5/8	240/3	H56	1	59.5	74.8	16077	CL00A310T-1	151275	RTA1-J	1.8	2.7	151189
	AO-H274	1.0	5/8	480/3	H56	1	59.5	74.8	16077	CL00A310T-1	151275	RTA1-F	0.7	1.1	151186
	AO-H276	0.7	5/8	575/3	J56	1.2	76.4	77	105568	CL00A310T-1	151275	RTA1-F	0.7	1.1	151186
3/4	AO-F353	11.0	5/8	120/1	F56	—	—	—	115860	CL01A310T-1	151276	RTA1-P	10.0	16.0	151194
	AO-F353	5.4	5/8	208/1	F56	—	—	—	115860	CL00A310T-1	151275	RTA1-L	4.0	6.3	151191
	AO-F353	5.5	5/8	240/1	F56	—	—	—	159184	CL00A310T-1	151275	RTA1-L	4.0	6.3	151191
	AO-H580	2.0	5/8	208/3	KA56	1	73.5	81.1	20371	CL00A310T-1	151275	RTA1-J	1.8	2.7	151189
	AO-H580	2.2	5/8	240/3	KA56	1	73.5	81.1	20371	CL00A310T-1	151275	RTA1-J	1.8	2.7	151189
	AO-H580	1.1	5/8	480/3	KA56	1	73.5	81.1	20371	CL00A310T-1	151275	RTA1-G	1.0	1.5	151187
	AO-H461	0.8	5/8	575/3	L56	1.2	78.3	82	105569	CL00A310T-1	151275	RTA1-F	0.7	1.1	151186

*SF = service factor, PF = power factor, and EFF = efficiency.

BLOWER MOTOR, MOTOR CONTACTOR, AND STARTER CONTACTOR—CONTINUED

Units Manufactured *After* AUG 2003—Continued

HP	Motor									Starter (Option AN10)					
	MFR's Model	Full Load Amps (FLA)	Shaft Size (IN)	Voltage/Phase	Frame Size	SF*	PF*	EFF* (%)	PN	Starter Contactor		Starter Overload			
										MFR's Model	PN	GE Model	Min Amps	Max Amps	PN
1	AO-159105	12.0	5/8	120/1	L56	—			174993	CL01A310T-1	151276	RTA1-P	10.0	16.0	151194
	AO-159105	6.2	5/8	208/1	L56	—			174993	CL00A310T-1	151275	RTA1-L	4.0	6.3	151191
	AO-159105	6.0	5/8	240/1	L56	—			174993	CL00A310T-1	151275	RTA1-L	4.0	6.3	151191
	AO-H524	3.3	5/8	208/3	J56	1	74.4	80.2	16080	CL00A310T-1	151275	RTA1-K	2.5	4.1	151190
	AO-H524	3.4	5/8	240/3	J56	1	74.4	80.2	16080	CL00A310T-1	151275	RTA1-K	2.5	4.1	151190
	AO-H524	1.7	5/8	480/3	J56	1	74.4	80.2	16080	CL00A310T-1	151275	RTA1-K	1.3	1.9	151188
	AO-H525	1.4	5/8	575/3	H56	1.2	71.6	80.4	105570	CL00A310T-1	151275	RTA1-H	1.0	1.5	151187
1.5	AO-311P402	16.4	5/8	120/1	TK56H	—			94347	CL02A310T-1	151277	RTA1-S	14.5	18.0	151196
	AO-311P402	9.5	5/8	208/1	TK56H	—			94347	CL00A310T-1	151275	RTA1-N	8.0	12.0	151193
	AO-311P402	8.2	5/8	240/1	TK56H	—			94347	CL00A310T-1	151275	RTA1-N	8.0	12.0	151193
	AO-H535	4.3	5/8	208/3	L56H	1	80.9	82.4	101286	CL00A310T-1	151275	RTA1-L	4.0	6.3	151191
	AO-H535	4.4	5/8	240/3	L56H	1	80.9	82.4	101286	CL00A310T-1	151275	RTA1-L	4.0	6.3	151191
	AO-H535	2.2	5/8	480/3	L56H	1	80.9	82.4	101286	CL00A310T-1	151275	RTA1-J	1.8	2.7	151189
	AO-E127	1.6	7/8	575/3	M145T	1.2	85.7	84	105665	CL00A310T-1	151275	RTA1-H	1.3	1.9	151188
2	AO-K200	24.0	1-1/8	120/1	F182T	—			105572	CL04A310M-1	151279	RTA1-U	21.0	26.0	151198
	L3516TM	8.3	7/8	240/1	56HZ	1.2	99	78	205881	CL00A310T-1	151275	RTA1-M	5.5	8.5	151192
	AO-E166	7.0	7/8	208/3	145T	—			158165	CL00A310T-1	151275	RTA1-M	5.5	8.5	151192
	AO-E166	5.8	7/8	240/3	145T	—			158165	CL00A310T-1	151275	RTA1-L	4.0	6.3	151191
	AO-E166	2.9	7/8	480/3	145T	—			158165	CL00A310T-1	151275	RTA1-K	2.5	4.1	151190
	AO-E169	2.3	7/8	575/3	145T	—			158166	CL00A310T-1	151275	RTA1-J	1.9	2.7	151189
3	AO-K222	30.0	1-1/8	120/1	F184T	—			111564	CL04A310M-1	151279	RTA1-V	25.0	32.0	151199
	AO-K222	15.0	1-1/8	240/1	F184T	—			111564	CL02A310T-1	151277	RTA1-S	14.5	18.0	151196
	B-M3559T	7.9	7/8	208/3	145T	—			159330	CL00A310T-1	151275	RTA1-M	5.5	8.5	151192
	B-M3559T	7.2	7/8	240/3	145T	—			159330	CL00A310T-1	151275	RTA1-M	5.5	8.5	151192
	B-M3559T	3.6	7/8	480/3	145T	—			159330	CL00A310T-1	151275	RTA1-K	2.5	4.1	151190
	B-M3559T-5	3.0	7/8	575/3	145T	—			111571	CL00A310T-1	151275	RTA1-K	2.5	4.1	151190
5	AO-K223	20.2	1-1/8	240/1	F184T	—			111567	CL25A310T-1	1024071	RTA1-T	17.5	22.0	1024078
	AO-E241	16.0	1-1/8	208/3	184T	—			155048	CL02A310T-1	151277	RTA1-S	14.5	18.0	151196
	AO-E241	12.0	1-1/8	240/3	184T	—			155048	CL01A310T-1	151276	RTA1-P	10.0	16.0	151194
	AO-E241	6.0	1-1/8	480/3	184T	—			155048	CL00A310T-1	151275	RTA1-L	4.0	6.3	151191
	AO-E273	4.8	1-1/8	575/3	184T	—			158170	CL00A310T-1	151275	RTA1-L	4.0	6.3	151191
7.5	AO-K305	34.0	1-3/8	240/1	F215T	—			105842	CL06A311M-1	203687	RTA2-E	30.0	43.0	151206
	AO-E356	24.0	1-3/8	208/3	213T	—			158171	CL04A310M-1	151279	RTA1-U	21.0	26.0	151198
	AO-E356	19.0	1-3/8	240/3	213T	—			158171	CL25A310T-1	1024071	RTA1-T	17.5	22.0	1024078
	AO-E356	9.5	1-3/8	480/3	213T	—			158171	CL00A310T-1	151275	RTA1-N	8.0	12.0	151193
	AO-E364	7.6	1-3/8	575/3	213T	—			158172	CL00A310T-1	151275	RTA1-M	5.5	8.5	151192
10	AO-K313	39.0	1-3/8	240/1	215T	—			105846	CL06A311M-1	203687	RTA2-E	30.0	43.0	151206
	AO-E357	30.0	1-3/8	208/3	215T	—			158173	CL04A310M-1	151279	RTA1-V	25.0	32.0	151199
	AO-E357	26.0	1-3/8	240/3	215T	—			158173	CL04A310M-1	151279	RTA1-U	21.0	26.0	151198
	AO-E357	13.0	1-3/8	480/3	215T	—			158173	CL02A310T-1	151277	RTA1-P	10.0	16.0	151194
	AO-E365	9.6	1-3/8	575/3	215T	—			158174	CL00A310T-1	151275	RTA1-N	8.0	12.0	151193
15	BAL-FM2333T	38.0	1-5/8	240/3	254T	1.2	82	90.2	142443	CL06A311M-1	203687	RTA2-E	30.0	43.0	151206
	BAL-FM2333T	19.0	1-5/8	480/3	254T	1.2	82	90.2	142443	CL25A310T-1	1024071	RTA1-T	17.5	22.0	1024078
	B-FM2333-5	15.0	1-5/8	575/3	254T	1.2	82	90.2	142444	CL02A310T-1	151277	RTA1-P	10.0	16.0	151194
20	BAL-FM2334T	52.0	1-5/8	240/3	256T	1.2	81	89.5	142301	CL07A311M-1	203793	RTA2-G	42.0	55.0	151202
	BAL-FM2334T	26.0	1-5/8	480/3	256T	1.2	81	89.5	142301	CL04A310M-1	151279	RTA1-V	25.0	32.0	151199
	B-FM2334T-5	20.6	1-5/8	575/3	256T	1.2	81	89.5	142302	CL25A310T-1	1024071	RTA1-T	17.5	22.0	1024078

*SF = service factor, PF = power factor, and EFF = efficiency.

**Table 10. EE-Type Blower Motors with Starters/Overloads
(Units Manufactured After AUG 2003)**

HP	Motor									Starter (Option AN10)					
	MFR's Model	Full Load Amps (FLA)	Shaft Size (IN)	Voltage/Phase	Frame Size	SF*	PF* (%)	EFF* (%)	PN	Starter Contactor		Starter Overload			
										MFR's Model	PN	GE Model	Min Amps	Max Amps	PN
1	AO-E103	3.1	7/8	208/3	N143T	—	—	—	105659	CL00A310T-1	151275	RTA1-K	2.5	4.1	151190
	AO-E1015	2.7	7/8	240/3	143T	—	—	—	159328	CL00A310T-1	151275	RTA1-K	2.5	4.1	151190
	AO-E1015	1.4	7/8	480/3	143T	—	—	—	159328	CL00A310T-1	151275	RTA1-G	1.0	1.5	151187
	AO-E1006	1.1	7/8	575/3	N143T	—	—	—	158175	CL00A310T-1	151275	RTA1-G	1.0	1.5	151187
1.5	AO-E104	4.5	7/8	208/3	P145T	—	—	—	105662	CL00A310T-1	151275	RTA1-L	4.0	6.3	151191
	AO-E1016	3.9	7/8	240/3	145T	—	—	—	159329	CL00A310T-1	151275	RTA1-K	2.5	4.1	151190
	AO-E1016	2.0	7/8	480/3	145T	—	—	—	159329	CL00A310T-1	151275	RTA1-J	1.9	2.7	151189
	AO-E1007	1.6	7/8	575/3	R145T	—	—	—	158162	CL00A310T-1	151275	RTA1-H	1.3	1.9	151188
2	AO-E105	6.0	7/8	208/3	P145T	—	—	—	105664	CL00A310T-1	151275	RTA1-L	4.0	6.3	151191
	AO-E1017	5.8	7/8	240/3	145T	—	—	—	159027	CL00A310T-1	151275	RTA1-L	4.0	6.3	151191
	AO-E1017	2.9	7/8	480/3	145T	—	—	—	159027	CL00A310T-1	151275	RTA1-K	2.5	4.1	151190
	AO-E1008	2.1	7/8	575/3	P145T	—	—	—	158176	CL00A310T-1	151275	RTA1-J	1.9	2.7	151189
3	B-35L405S489G3	8.3	7/8	208/3	145T	—	—	—	159186	CL00A310T-1	151275	RTA1-N	8.0	12.0	151193
	B-EM3158T	7.4	7/8	240/3	145T	—	—	—	159028	CL00A310T-1	151275	RTA1-M	5.5	8.5	151192
	B-EM3158T	3.7	7/8	480/3	145T	—	—	—	159028	CL00A310T-1	151275	RTA1-K	2.5	4.1	151190
	B-35L405S709G1	3.0	7/8	575/3	145T	—	—	—	159030	CL00A310T-1	151275	RTA1-K	2.5	4.1	151190
5	AO-E204	13.9	1-1/8	208/3	H182T	—	—	—	159029	CL02A310T-1	151277	RTA1-P	10.0	16.0	151194
	AO-E204	11.6	1-1/8	240/3	H182T	—	—	—	159029	CL01A310T-1	151276	RTA1-P	10.0	16.0	151194
	AO-E204	5.8	1-1/8	480/3	H182T	—	—	—	159029	CL00A310T-1	151275	RTA1-M	5.5	8.5	151192
	BAL-M3613T-5	4.8	1-1/8	575/3	184T	—	—	—	111602	CL00A310T-1	151275	RTA1-L	4.0	6.3	151191
7.5	AO-E316	22.3	1-3/8	208/3	D213T	—	—	—	159331	CL04A310M-1	151279	RTA1-U	21.0	26.0	151198
	AO-E317	19.4	1-3/8	240/3	D213T	—	—	—	159332	CL25A310T-1	1024071	RTA1-T	17.5	22.0	1024078
	AO-E317	9.7	1-3/8	480/3	D213T	—	—	—	159332	CL00A310T-1	151275	RTA1-N	8.0	12.0	151193
	AO-E324	7.8	1-3/8	575/3	S213T	—	—	—	158164	CL00A310T-1	151275	RTA1-M	5.5	8.5	151192
10	AO-E397	27.8	1-3/8	208/3	H215T	—	—	—	159334	CL04A310M-1	151279	RTA1-V	25.0	32.0	151199
	AO-E397	24.2	1-3/8	240/3	H215T	—	—	—	159334	CL04A310M-1	151279	RTA1-U	21.0	26.0	151198
	AO-E397	12.1	1-3/8	480/3	H215T	—	—	—	159334	CL01A310T-1	151276	RTA1-P	10.0	16.0	151194
	AO-E325	10.4	1-3/8	575/3	S215T	—	—	—	158163	CL01A310T-1	151276	RTA1-P	10.0	16.0	151194
15	B-EFM2513T-8	41.5	1-5/8	208/3	254T	1.2	84	92.4	142440	CL06A311M-1	203687	RTA2-E	30.0	43.0	151206
	B-EFM2513T	36.0	1-5/8	240/3	254T	1.2	84	92.4	142441	CL06A311M-1	203687	RTA2-E	30.0	43.0	151206
	B-EFM2513T	18.0	1-5/8	480/3	254T	1.2	84	92.4	142441	CL25A310T-1	1024071	RTA1-T	17.5	22.0	1024078
	B-EFM2513T-5-F2	16.0	1-5/8	575/3	254T	1.2	84	92.4	142289	CL02A310T-1	151277	RTA1-P	10.0	16.0	151194
20	C-E452-F2	57.0	1-5/8	208/3	S256T	1.2	84	93.6	159187	CL07A311M-1	203793	RTA2-H	54.0	65.0	151203
	B-EFM2515T	48.0	1-5/8	240/3	256T	1.2	84	93.0	142299	CL07A311M-1	203793	RTA2-G	42.0	55.0	151202
	B-EFM2515T	24.0	1-5/8	480/3	256T	1.2	84	93.0	142299	CL04A310M-1	151279	RTA1-U	21.0	26.0	151198
	B-EFM2515T-5	19.2	1-5/8	575/3	256T	1.2	84	93.0	142300	CL25A310T-1	1024071	RTA1-T	17.5	22.0	1024078

*SF = service factor, PF = power factor, and EFF = efficiency.

BLOWER MOTOR, MOTOR CONTACTOR, AND STARTER CONTACTOR—CONTINUED

Units Manufactured *After* AUG 2003—Continued

Table 11. Two-Speed Blower Motor and Starter Data								
Two-Speed Blower Motor							IEC Starter PN	
Rated HP	MFR's Model	Frame Size	Shaft Size (Inches)	Maximum Motor Amp Draw (rpm)		Voltage/Phase		
				1800	1200			
1.00–0.44	M124	M145T	7/8	3.8	2.4	208/3	105641	222180
	M124	M145T	7/8	3.4	2.2	240/3	105641	114971
	M109	M145T	7/8	1.7	1.1	480/3	105642	114972
1.50–0.68	M125	N145T	7/8	5.4	3.1	208/3	105643	222181
	M125	N145T	7/8	4.9	2.8	240/3	105643	114973
	M104	N145T	7/8	2.4	1.4	480/3	105644	114974
2.00–0.88	M220	S182T	1-1/8	6.5	4.2	208/3	105645	222182
	M220	S182T	1-1/8	5.9	3.8	240/3	105645	114976
	M207	S182T	1-1/8	3.4	2.1	480/3	105646	114977
3.00–1.30	M221	S184T	1-1/8	9.3	5.3	208/3	105647	222183
	M221	S184T	1-1/8	8.4	4.8	240/3	105647	114978
	M208	S184T	1-1/8	4.6	2.6	480/3	105648	114979
5.00–2.20	M320	S215T	1-3/8	17.2	11.3	208/3	105870	222184
	M320	S215T	1-3/8	15.5	10.2	240/3	105870	114980
	M305	S215T	1-3/8	7.1	4.8	480/3	105871	114981
7.50–3.30	M317	Y215T	1-3/8	21.6	13.6	208/3	105872	222185
	M317	Y215T	1-3/8	19.5	12.3	240/3	105872	114982
	M315	D215T	1-3/8	10.0	6.0	480/3	105873	114983
10.00–4.40	M421	S256T	1-5/8	31.0	19.4	208/3	105874	222186
	M421	S256T	1-5/8	28.0	17.5	240/3	105874	114984
	M413	S256T	1-5/8	13.5	7.5	480/3	105875	114985
15.00–6.70	M521	S284T	1.9	47.0	22.0	208/3	165726	165733
	M521	S284T	1.9	54.0	21.0	230/3	165726	165736
	M423	S256T	1.6	20.0	10.5	460/3	165727	165734
20.00–8.90	M522	S286T	1.9	56.0	29.0	208/3	165728	165735
	M522	S286T	1.9	51.0	27.0	230/3	165728	165736
	M504	S286T	1.9	24.0	12.0	460/3	165729	165737

NOTE: 690V, NO auxiliary contacts = PN [115951](#). 690V NC auxiliary contacts = PN [115952](#).

Table 12. Replacement Coils			
For Use with Starter Contactor GE Model Numbers Beginning with:	Replacement Coil PN	Voltage	GE Model
CL00, CL01, CL02, CL25	151280	24	LB1A-C
	151281	120	LB1A-J
	151282	208	LB1A-L
	151283	230	LB1A-S
	151284	460	LB1A-U
	151285	575	LB1A-Y
CL04, CL45	151286	24	LB3A-C
	151287	120	LB3A-J
	151288	208	LB3A-L
	151289	230	LB3A-S
	151290	460	LB3A-U
	151291	575	LB3A-Y
CL06, CL07, CL08, CL09	151292	208	LB4A-L
	151293	230	LB4A-S
	151294	460	LB4A-U

Units Manufactured *Before* SEP 2003

NOTE:

- NEMA starters are used on units manufactured before OCT 1992. Replacement parts for NEMA starters are shown in [Figure 5](#).
- In OCT 1990, motor starter coils were changed to line voltage. Replacement motors are listed in [Table 13](#), [Table 14](#), and [Table 15](#) by type and horsepower for open-type motors, TEFC-type (totally-enclosed fan-cooled) motors, and EE-type (premium-efficiency) motors.
- Replacement coils for units with line voltage starter contactors are listed in [Table 12](#).
- Replacement parts for NEMA starters are listed in [Table 16](#).

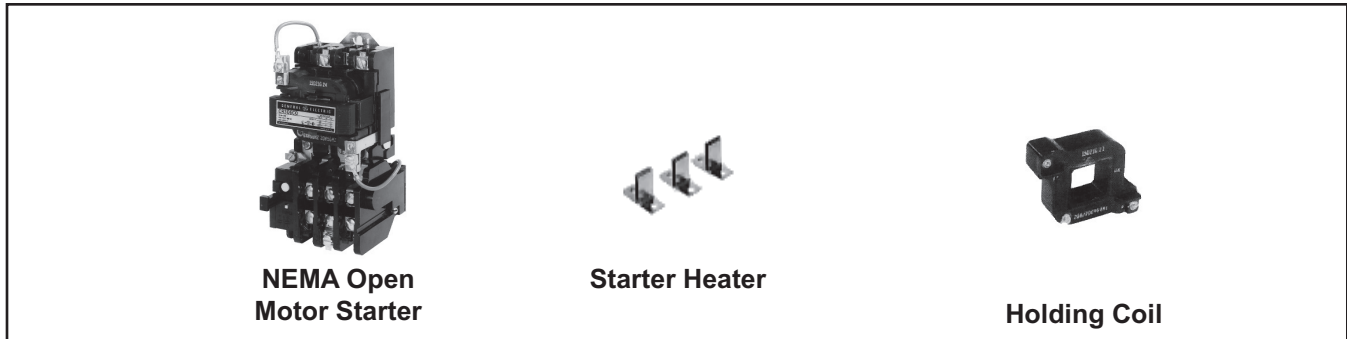

Figure 5. Replacement Parts for NEMA Starters

Table 13. Open-Type Blower Motors with Starters/Overloads
(Units Manufactured *Before* SEP 2003)

HP	Motor		Starter Contactor		Starter Overload			
	Voltage/ Phase	PN	MFR's Model	PN	GE Model	Min Amps	Max Amps	PN
1/2	120/1	102627	CL00A310T-J	151146	RTA1-N	8.00	12.00	151193
	208/1	102627	CL00A310T-L	151150	RTA1-L	4.00	6.30	151191
	240/1	102627	CL00A310T-S	151147	RTA1-L	4.00	6.30	151191
	208/3	159183	CL00A310T-L	151150	RTA1-J	1.90	2.70	151189
	240/3	159183	CL00A310T-S	151147	RTA1-K	2.50	4.10	151190
	480/3	159183	CL00A310T-U	151148	RTA1-H	1.30	1.90	151188
3/4	120/1	93548	CL01A310T-J	151151	RTA1-P	10.00	16.00	151194
	208/1	93548	CL00A310T-L	151150	RTA1-M	5.50	8.50	151192
	240/1	93548	CL00A310T-S	151147	RTA1-L	4.00	6.30	151191
	208/3	36951	CL00A310T-L	151150	RTA1-K	2.50	4.10	151190
	240/3	36951	CL00A310T-S	151147	RTA1-K	2.50	4.10	151190
	480/3	36951	CL00A310T-U	151148	RTA1-G	1.00	1.50	151187
1	120/1	13685	CL01A310T-J	151151	RTA1-P	10.00	16.00	151194
	208/1	13685	CL00A310T-L	151150	RTA1-M	5.50	8.50	151192
	240/1	13685	CL00A310T-S	151147	RTA1-M	5.50	8.50	151192
	208/3	36580	CL00A310T-L	151150	RTA1-K	2.50	4.10	151190
	240/3	36580	CL00A310T-S	151147	RTA1-K	2.50	4.10	151190
	480/3	36580	CL00A310T-U	151148	RTA1-H	1.30	1.90	151188
	575/3	158175	CL00A310T-Y	151149	RTA1-G	1.00	1.50	151187
1.5	120/1	194202	CL02A310T-J	151156	RTA1-P	10.00	16.00	151194
	208/1	194202	CL00A310T-L	151150	RTA1-M	5.50	8.50	151192
	240/1	194202	CL00A310T-S	151147	RTA1-M	5.50	8.50	151192
	208/3	115859	CL00A310T-L	151150	RTA1-L	4.00	6.30	151191
	240/3	115859	CL00A310T-S	151147	RTA1-L	4.00	6.30	151191
	480/3	115859	CL00A310T-U	151148	RTA1-K	2.50	4.10	151190
	575/3	158162	CL00A310T-Y	151149	RTA1-H	1.30	1.90	151188

BLOWER MOTOR, MOTOR CONTACTOR, AND STARTER CONTACTOR—CONTINUED

Units Manufactured *Before* SEP 2003—Continued

Table 13. Open-Type Blower Motors with Starters/Overloads (Units Manufactured <i>Before</i> SEP 2003)—Continued								
HP	Motor		Starter Contactor		Starter Overload			
	Voltage/ Phase	PN	MFR's Model	PN	GE Model	Min Amps	Max Amps	PN
2	120/1	202581	CL25A310T-J	1024072	RTA1-T	17.50	22.00	151197
	208/1	202581	CL01A310T-L	151155	RTA1-N	8.00	12.00	151193
	240/1	202581	CL01A310T-S	151152	RTA1-N	8.00	12.00	151193
	208/3	159327	CL00A310T-L	151150	RTA1-M	5.50	8.50	151192
	240/3	159327	CL00A310T-S	151147	RTA1-M	5.50	8.50	151192
	480/3	159327	CL00A310T-U	151148	RTA1-K	2.50	4.10	151190
	575/3	158176	CL00A310T-Y	151149	RTA1-J	1.90	2.70	151189
3	208/1	111560	CL02A310T-L	151159	RTA1-P	10.00	16.00	151194
	240/1	111560	CL01A310T-S	151152	RTA1-P	10.00	16.00	151194
	208/3	159185	CL00A310T-L	151150	RTA1-N	8.00	12.00	151193
	240/3	159185	CL00A310T-S	151147	RTA1-N	8.00	12.00	151193
	480/3	159185	CL00A310T-U	151148	RTA1-L	4.00	6.30	151191
	575/3	120019	CL00A310T-Y	151149	RTA1-K	2.50	4.10	151190
	208/3	152002	—	—	RTA1-N	8.00	12.00	151193
	240/3	152002	—	—	RTA1-M	5.50	8.50	151192
480/3	152002	—	—	RTA1-K	2.50	4.10	151190	
5	208/1	111562	CL04A310M-L	151169	RTA1-V	25.00	32.00	151199
	240/1	111562	CL04A310M-S	151166	RTA1-V	25.00	32.00	151199
	208/3	113371	CL01A310T-L	151155	RTA1-P	10.00	16.00	151194
	240/3	113371	CL01A310T-S	151152	RTA1-P	10.00	16.00	151194
	480/3	113371	CL00A310T-U	151148	RTA1-M	5.50	8.50	151192
	575/3	120020	CL00A310T-Y	151149	RTA1-L	4.00	6.30	151191
7.5	208/1	105828	CL06A311M-L	151173	RTA2-E	30.00	43.00	151206
	240/1	105828	CL45A310M-S	151170	RTA1-V	25.00	32.00	151199
	208/3	105855	CL25A310T-L	1024076	RTA1-U	21.00	26.00	1024078
	240/3	105855	CL25A310T-S	1024073	RTA1-T	17.50	22.00	1024078
	480/3	105855	CL01A310T-U	151153	RTA1-N	8.00	12.00	151193
	575/3	158164	CL00A310T-Y	151149	RTA1-M	5.50	8.50	151192
10	208/1	105830	CL06A311M-L	151173	RTA2-E	30.00	43.00	151206
	240/1	105830	CL06A311M-S	151172	RTA2-E	30.00	43.00	151206
	208/3	105857	CL04A310M-L	151169	RTA1-V	25.00	32.00	151199
	240/3	105858	CL04A310M-S	151166	RTA1-V	25.00	32.00	151199
	480/3	105858	CL01A310T-U	151153	RTA1-P	10.00	16.00	151194
	575/3	158163	CL01A310T-Y	151154	RTA1-P	10.00	16.00	151194
15	208/3	142287	CL06A311M-L	151173	RTA2-G	42.00	55.00	151202
	240/3	142288	CL06A311M-S	151172	RTA2-E	30.00	43.00	151206
	480/3	142288	CL25A310T-U	1024074	RTA1-T	17.50	22.00	1024078
	575/3	142289	CL02A310T-Y	151158	RTA1-S	14.50	18.00	151196
20	208/3	142295	CL07A311M-L	151176	RTA2-H	54.00	65.00	151203
	240/3	142296	CL07A311M-S	151175	RTA2-G	42.00	55.00	151202
	480/3	142296	CL04A310M-U	151167	RTA1-V	25.00	32.00	151199
	575/3	142297	CL25A310T-Y	1024075	RTA1-T	17.50	22.00	1024078
25	208/3	159021	CL09A311M-L	151179	RTA2-J	64.00	82.00	151204
	240/3	159022	CL08A311M-S	151177	RTA2-H	54.00	65.00	151203
	480/3	159022	CL45A310M-U	151171	RTA1-V	25.00	32.00	151199
	575/3	159023	CL04A310M-Y	151168	RTA1-U	21.00	26.00	151198
30	208/3	159024	CL09A311M-L	151179	RT2-J	64.00	82.00	151204
	240/3	159025	CL09A311M-S	151178	RT2-J	64.00	82.00	151204
	480/3	159025	CL06A311M-U	151174	RTA2-E	30.00	43.00	151206
	575/3	159026	CL04A310M-Y	119852	RTA1-V	25.00	32.00	151199

**Table 14. TEFC-Type Blower Motors with Starters/Overloads
(Units Manufactured Before SEP 2003)**

HP	Motor		Starter Contactor		Starter Overload			
	Voltage/ Phase	PN	MFR's Model	PN	GE Model	Min Amps	Max Amps	PN
1/2	120/1	159184	CL00A310T-J	151146	RTA1-M	5.50	8.50	151192
	208/1	159184	CL00A310T-L	151150	RTA1-K	2.50	4.10	151190
	240/1	159184	CL00A310T-S	151147	RTA1-K	2.50	4.10	151190
	208/3	16077	CL00A310T-L	151150	RTA1-J	1.90	2.70	151189
	240/3	16077	CL00A310T-S	151147	RTA1-J	1.90	2.70	151189
	480/3	16077	CL00A310T-U	151148	RTA1-F	0.65	1.10	151186
	575/3	105568	CL00A310T-Y	151149	RTA1-F	0.65	0.90	151186
3/4	120/1	115860	CL01A310T-J	151151	RTA1-P	10.00	16.00	151194
	208/1	115860	CL00A310T-L	151150	RTA1-L	4.00	6.30	151191
	240/1	115860	CL00A310T-S	151147	RTA1-L	4.00	6.30	151191
	208/3	20371	CL00A310T-L	151150	RTA1-J	1.90	2.70	151189
	240/3	20371	CL00A310T-S	151147	RTA1-J	1.90	2.70	151189
	480/3	20371	CL00A310T-U	151148	RTA1-G	1.00	1.50	151187
	575/3	105569	CL00A310T-Y	151149	RTA1-F	0.65	1.10	151186
1	120/1	174993	CL01A310T-J	151151	RTA1-P	10.00	16.00	151194
	208/1	174993	CL00A310T-S	151147	RTA1-M	5.50	8.50	151192
	240/1	174993	CL00A310T-S	151147	RTA1-M	5.50	8.50	151192
	208/3	16080	CL00A310T-L	151150	RTA1-K	2.50	4.10	151190
	240/3	16080	CL00A310T-S	151147	RTA1-K	2.50	4.10	151190
	480/3	16080	CL00A310T-U	151148	RTA1-H	1.30	1.90	151188
	575/3	105570	CL00A310T-Y	151149	RTA1-G	1.00	1.50	151187
1.5	120/1	94347	CL02A310T-J	151156	RTA1-S	14.50	18.00	151196
	208/1	94347	CL00A310T-L	151150	RTA1-N	8.00	12.00	151193
	240/1	94347	CL00A310T-S	151147	RTA1-N	8.00	12.00	151193
	208/3	101286	CL00A310T-L	151150	RTA1-L	4.00	6.30	151191
	240/3	101286	CL00A310T-S	151147	RTA1-L	4.00	6.30	151191
	480/3	101286	CL00A310T-U	151148	RTA1-J	1.90	2.70	151189
	575/3	105665	CL00A310T-Y	151149	RTA1-H	1.30	1.90	151188
2	120/1	105572	CL04A310M-J	151165	RTA1-U	21.00	26.00	151198
	240/1	105572	CL01A310T-S	151152	RTA1-P	10.00	16.00	151194
	208/3	158165	CL00A310T-L	151150	RTA1-M	5.50	8.50	151192
	240/3	158165	CL00A310T-S	151147	RTA1-L	4.00	6.30	151191
	480/3	158165	CL00A310T-U	151148	RTA1-K	2.50	4.10	151190
	575/3	158166	CL00A310T-Y	151149	RTA1-J	1.90	2.70	151189
	120/1	111564	CL04A310M-J	151165	RTA1-V	25.00	32.00	151199
3	240/1	111564	CL02A310T-S	151157	RTA1-P	10.00	16.00	151194
	208/3	159330	CL00A310T-L	151150	RTA1-N	5.50	8.50	151192
	240/3	159330	CL00A310T-S	151147	RTA1-N	5.50	8.50	151192
	480/3	159330	CL00A310T-U	151148	RTA1-K	2.50	4.10	151190
	575/3	111571	CL00A310T-Y	151149	RTA1-K	2.50	4.10	151190
	240/1	111567	CL04A310M-S	151166	RTA1-T	17.50	22.00	151197
	208/3	155048	CL01A310T-L	151155	RTA1-S	14.50	18.00	151196
5	240/3	155048	CL01A310T-S	151152	RTA1-P	10.00	16.00	151194
	480/3	155048	CL00A310T-U	151148	RTA1-L	4.00	6.30	151191
	575/3	158170	CL00A310T-Y	151149	RTA1-L	4.00	6.30	151191
	240/1	105842	CL45A310M-S	151170	RTA1-W	30.00	40.00	151200
	208/3	158171	CL04A310M-L	151169	RTA1-U	21.00	26.00	151198
7.5	240/3	158171	CL25A310T-S	1024073	RTA1-T	17.50	22.00	1024078
	480/3	158171	CL01A310T-U	151153	RTA1-N	8.00	12.00	151193
	575/3	158172	CL00A310T-Y	151149	RTA1-N	5.50	8.50	151192
	240/1	105846	CL06A311M-S	151172	RTA2-E	30.00	43.00	151206
	208/3	158173	CL04A310M-L	151169	RTA1-V	25.00	32.00	151199
10	240/3	158173	CL04A310M-S	151166	RTA1-U	21.00	26.00	151198
	480/3	158173	CL01A310T-U	151153	RTA1-P	10.00	16.00	151194
	575/3	158174	CL01A310T-Y	151154	RTA1-N	8.00	12.00	151193

BLOWER MOTOR, MOTOR CONTACTOR, AND STARTER CONTACTOR—CONTINUED

Units Manufactured *Before* SEP 2003—Continued

HP	Motor		Starter Contactor		Starter Overload			
	Voltage/ Phase	PN	MFR's Model	PN	GE Model	Min Amps	Max Amps	PN
15	240/3	142443	CL06A311M-S	151172	RTA2-E	30.00	43.00	151206
	480/3	142443	CL25A310T-U	1024074	RTA1-T	17.50	22.00	1024078
	575/3	142444	CL02A310T-Y	151158	RTA1-P	10.00	16.00	151194
20	240/3	142301	CL07A311M-S	151175	RTA2-G	42.00	55.00	151202
	480/3	142301	CL04A310M-U	151167	RTA1-V	25.00	32.00	151199
	575/3	142302	CL25A310T-Y	1024075	RTA1-T	17.50	22.00	1024078
25	208/3	165321	CL09A311M-L	151179	RT2-J	64.00	82.00	151204
	240/3	165321	CL07A311M-S	151175	RT2-H	54.00	65.00	151203
	480/3	165321	CL04A310M-U	151167	RT1-V	25.00	32.00	151199
	575/3	165322	CL04A310M-Y	151168	RT1-U	21.00	26.00	151198
30	208/3	165323	CL10A311M-L	166756	RT2-L	78.00	97.00	151205
	240/3	165323	CL09A311M-S	151178	RT2-J	64.00	82.00	151204
	480/3	165323	CL06A311M-U	151174	RT2-E	30.00	43.00	151206
	575/3	165324	CL04A310M-Y	151168	RT1-V	25.00	32.00	151199

HP	Motor		Starter Contactor		Starter Overload			
	Voltage/ Phase	PN	MFR's Model	PN	GE Model	Min Amps	Max Amps	PN
1	208/3	105659	CL00A310T-L	151150	RTA1-K	2.50	4.10	151190
	240/3	159328	CL00A310T-S	151147	RTA1-K	2.50	4.10	151190
	480/3	159328	CL00A310T-U	151148	RTA1-G	1.00	1.50	151187
	575/3	158175	CL00A310T-Y	151149	RTA1-G	1.00	1.50	151187
1.5	208/3	105662	CL00A310T-L	151150	RTA1-L	4.00	6.30	151191
	240/3	159329	CL00A310T-S	151147	RTA1-K	2.50	4.10	151190
	480/3	159329	CL00A310T-U	151148	RTA1-J	1.90	2.70	151189
	575/3	158162	CL00A310T-Y	151149	RTA1-H	1.30	1.90	151188
2	208/3	105664	CL00A310T-L	151150	RTA1-L	4.00	6.30	151191
	240/3	159027	CL00A310T-S	151147	RTA1-L	4.00	6.30	151191
	480/3	159027	CL00A310T-U	151148	RTA1-K	2.50	4.10	151190
	575/3	158176	CL00A310T-Y	151149	RTA1-J	1.90	2.70	151189
3	208/3	159186	CL00A310T-L	151150	RTA1-N	8.00	12.00	151193
	240/3	159028	CL00A310T-S	151147	RTA1-N	5.50	8.50	151192
	480/3	159028	CL00A310T-U	151148	RTA1-K	2.50	4.10	151190
	575/3	159030	CL00A310T-Y	151149	RTA1-K	2.50	4.10	151190
5	208/3	159029	CL02A310T-L	151159	RTA1-P	10.00	16.00	151194
	240/3	159029	CL02A310T-S	151157	RTA1-P	10.00	16.00	151194
	480/3	159029	CL00A310T-U	151148	RTA1-M	5.50	8.50	151192
	575/3	111602	CL00A310T-Y	151149	RTA1-L	4.00	6.30	151191
7.5	208/3	159331	CL04A310M-L	151169	RTA1-U	21.00	26.00	151198
	240/3	159332	CL25A310T-S	1024073	RTA1-T	17.50	22.00	1024078
	480/3	159332	CL00A310T-U	151148	RTA1-N	8.00	12.00	151193
	575/3	158164	CL00A310T-Y	151149	RTA1-N	5.50	8.50	151192
10	208/3	159333	CL04A310M-L	151169	RTA1-V	25.00	32.00	151199
	240/3	159334	CL04A310M-S	151166	RTA1-U	21.00	26.00	151198
	480/3	159334	CL01A310T-U	151153	RTA1-P	10.00	16.00	151194
	575/3	158163	CL00A310T-Y	151149	RTA1-P	10.00	16.00	151194
15	208/3	142440	CL06A311M-L	151173	RTA2-E	30.00	43.00	151206
	240/1	142441	CL06A311M-S	151172	RTA2-E	30.00	43.00	151206
	480/3	142441	CL25A310T-U	1024074	RTA1-T	17.50	22.00	1024078
	575/3	142289	CL02A310T-Y	151158	RTA1-P	10.00	16.00	151194

**Table 15. EE-Type Blower Motors with Starters/Overloads
(Units Manufactured Before SEP 2003)—Continued**

HP	Motor		Starter Contactor		Starter Overload			
	Voltage/Phase	PN	MFR's Model	PN	GE Model	Min Amps	Max Amps	PN
15	208/3	142440	CL06A311M-L	151173	RTA2-E	30.00	43.00	151206
	240/1	142441	CL06A311M-S	151172	RTA2-E	30.00	43.00	151206
	480/3	142441	CL25A310T-U	1024074	RTA1-T	17.50	22.00	1024078
	575/3	142289	CL02A310T-Y	151158	RTA1-P	10.00	16.00	151194
20	208/3	159187	CL07A311M-L	151176	RTA2-H	54.00	65.00	151203
	240/3	142299	CL06A311M-S	151172	RTA2-G	42.00	55.00	151202
	480/3	142299	CL04A310M-U	151167	RTA1-U	21.00	26.00	151198
	575/3	142300	CL25A310T-Y	1024075	RTA1-T	17.50	22.00	1024078
25	208/3	159031	CL09A311M-L	151179	RT2-J	64.00	82.00	151204
	240/3	159033	CL08A311M-S	151177	RT2-H	54.00	65.00	151203
	480/3	159033	CL04A310M-U	151167	RT1-V	25.00	32.00	151199
30	208/3	159032	CL10A311M-L	166756	RT2-L	78.00	97.00	151205
	240/3	159034	CL09A311M-S	151178	RT2-J	64.00	82.00	151204
	480/3	159034	CL06A311M-U	151174	RT2-E	30.00	43.00	151206

Table 16. Replacement Parts for NEMA Starters

Starter						Starter					
Size	Coil Voltage	GE Model	RDF-1	RDF-2	RDF-3	Size	Coil Voltage	GE Model	RDF-1	RDF-2	RDF-3
			PN						PN		
0	24	CR306B024	39919	39919	39919	2	24	CR306D024	—	39921	39921
	115	CR306B002	111523	—			208	CR306D023	—	111528	111528
	208	CR306B023	111524	111524	—		230	CR306D003	—	111529	111529
	230	CR306B003	111525	111525	—		460	CR306D004	—	111530	111530
	460	CR306B004	111522	111522	111522		3	24	CR306E024	—	39922
1	24	CR306C024	39920	39920	39920	208		CR306E023	—	111531	111531
	115	CR306C002	111526	—		230		CR306E003	—	—	111533
	208	CR306C023	111499	111499	—	460		CR306E004	—	—	111532
	230	CR306C003	111521	111521	—	575		CR306E004	—	—	119852
	460	CR306C004	111527	111527	—	4	24	CR306F024	—	—	91519
Heater							Heater				
HP	Voltage/Phase	GE Model	PN			HP	Voltage/Phase	GE Model	PN		
5	208/3	CR123C18.0B	89941 or 110617			15	208/3	CR123F56.7B	91543		
	208/3	CR123C19.8B	91542				230/3	CR123FC40.0B	89933		
	230/3	CR123C16.3B	16193 or 110626				460/3	CR123C21.4B	19556		
	460/3	CR123C8.67A	16192 or 110619				20	208/3	CR123F77.28B	91544	
7.5	208/3	CR123C25.0B	16196			230/3		CR123F65.8B	91545		
	230/3	CR123C22.8B	89924 or 110622			25	208/3	CR123F91.4B	91546		
	460/3	CR123C12.5B	17257 or 110624				230/3	CR123F77.28B	91544		
10	208/3	CR123C33.0B	89947 or 110625			30	460/3	CR123C36.6B	16195		
	230/3	CR123C30.3B	89949 or 110627				208/3	CR123F10.4C	91547		
	460/3	CR123C137B	110623				230/3	CR123F91.4B	91546		
		CR123C16.3B	16193 or 110626				460/3	FA30B	119851		
Holding Coil						Holding Coil					
Size	Coil Voltage	GE Model	PN			Size	Coil Voltage	GE Model	PN		
0/1	24	15D21G024	48531			2	230	15D22G003	111928		
	115	15D21G002	48507				460	15D22G004	111929		
	208	15D21G023	48509			3	24	55-501336G024	95093		
	230	15D21G003	73795				208	55-501336G023	111931		
	460	15D21G004	48512				230	55-501336G003	111933		
	575	15D21G005	73601				460	55-501336G004	111932		
2	24	15D22G024	93957			4	24	55-501463G024	102816		
	208	15D22G023	111927				208	55-501463G023	111935		

GAS REGULATORS, GAS VALVES, AND GAS PRESSURE SWITCHES

NOTE:

- Gas regulators, gas valves, and gas pressure switches are listed in [Table 17](#).
- Gas pressure regulators are shown in [Figure 6](#).
- Gas pressure valves are shown in [Figure 7](#).
- Gas pressure switches are shown in [Figure 8](#).

Table 17. Gas Regulators, Gas Valves, and Gas Pressure Switches

Item No.	Component	Description	Model/Size		
			1-20, 1-40, 1-50, 1-65	2-80, 2-120	3-180, 3-260
			PN		
1	Pressure regulator	1-inch, RV53-88	123950		
2	Regulator	1-inch manifold, 5 PSI to 6 IN WC, Maxitrol R600S	86964		
2A	Spring	Standard, brown, for propane, for lower pressure range of 1–3.5 IN WC	91787		
		Standard, cadmium, for natural gas, for pressure range of 3–6 IN WC, Maxitrol #R5310-36	97196		
		Optional, orange, for pressure range of 4–8 IN WC, Maxitrol #R5310-48	97351		
3	Pilot regulator	3/8-inch, Maxitrol #R400-S (replaced in JAN 1991 by PN 112644)	86965		
		3/8-inch, Maxitrol 325-3 (replaced PN 86965 in JAN 1991)	112644		
4	Gas control regulator	1-inch, Maxitrol M611 R-88	87001		
		1-1/4-inch, Maxitrol MR212D	N/A	89351	
		2-inch, Maxitrol MR212E	N/A	N/A	91071
5	Gas supply regulator kit	Outlet pressure range of 1–12 inches (5 PSI max), 1-inch x 1-inch NPT (same as option CZ1)	124258		
		Outlet pressure range of 1–12 inches (5 PSI max), 1-1/2-inch x 1-1/2-inch NPT (same as option CZ2)	124259		
6	Pilot valve	3/8-inch, 110V, G/C #S311AF02N6-CF5 (replaced in MAR 1996 by PN 145733)	86967		
		3/8-inch, 24V, G/C #S311AF02N6-CF5 (replaced in SEP 2003 by PN 204769)	145733		
		3/8-inch, 24V, M/H V8046C1030 (units manufactured after AUG 2003)	204769		
7	Pilot needle valve	Nupro B-4JNR (units manufactured from JAN 1991 through FEB 1996)	112462		
8	Conversion kit	Pilot needle valve (units manufactured before JAN 1991)	112645*		
8A	Regulator		112644		
8B	Elbow	Brass	93388		
8C	Needle valve	With tubing	112710		
9	Solenoid valve	1-inch, 120V, ASCO #K3A562-U (replaced in MAR 1996 by PN 146472)	86966		
		1-inch, 24V, ASCO #K3A561-U (units manufactured before SEP 2003)	146472		
10	Gas valve	Single-stage, 1-inch, natural gas or propane, M/H VR8404M5569 (units manufactured after AUG 2003)	159743		
11	Air controller	40–100°F (used as ductstat in option AG1 on units manufactured after AUG 2003)	126170		
12	Gas valve	Two-stage, 1-inch, natural gas, M/H V8944B-1126, used in option AG3 (units manufactured after AUG 2003)	203866		
13	Ductstat	2-stage, 60–110°F, T678A1015, used in option AG3	41700		
14	Vent valve	3/4-inch, G/C #S262	86996		
		1-inch, G/C #S262A02N3FJ5	—	91084	
15	Valve, natural gas or propane	1-inch, fluid power, serial No. code J2, J3, or J4, Honeywell #V5055A1004	86992		
		1-1/4-inch, fluid power, serial No. code K2, Honeywell #V5055A1012	—	89356	
		2-inch, fluid power, serial No. code K4, Honeywell #V5055A1038	—	91079	
15A	Actuator	120V, fluid-operated, Honeywell #V4055A1007	86993		
16	Manual gas valve	1-inch, Conbraco #50-4031 (replaced in JUL 1990 by PN 159725)	30257		
		1-1/4-inch, Conbraco #50-503-02 (replaced in JUL 1990 by PN 159729)	—	89350	
		2-inch, Conbraco #50-703-02 (replaced in JUL 1990 by PN 159735)	—	91072	
	Gas valve	1-inch, Watts B-6000-UL-TH (replaced PN 30257 in JUL 1990)	159725		
		1-1/4-inch, Watts B-6000-UL-TH (replaced PN 89350 in JUL 1990)	159729		
		2-inch, Watts B-6000-UL-TH (replaced PN 91072 in JUL 1990)	159735		

*Includes all parts needed to replace the pilot needle valve and change the regulator.

Table 17. Gas Regulators, Gas Valves, and Gas Pressure Switches—Continued

Item No.	Component	Description	Model/Size		
			1-20, 1-40, 1-50, 1-65	2-80, 2-120	3-180, 3-260
			PN		
16B	Adapter with test port	1-inch, ball valve	110758		
		1-1/4-inch, ball valve	110759		
		2-inch, ball valve	110760		
17	Pilot gas valve	3/8-inch, manual	159720		
18	Vent valve	3/4-inch, 24V, NO (not shown)	124010		
19	Pressure switch	Low gas pressure, automatic reset (replaced PN 93849 in SEP 2003)	204375**		
		Low gas pressure, automatic reset, set at 50% of minimum inlet gas pressure as stated on unit rating plate, Antunes #RLGP-A (replaced in SEP 2003 by PN 204375)	93849		
20	Pressure switch	High gas pressure, manual reset (replaced PN 93850 in SEP 2003)	204297**		
		High gas pressure, manual reset, set at 125% of normal manifold gas pressure as stated on unit rating plate, Antunes #HGP-AMI (replaced in SEP 2003 by PN 204297)	93850		
21	Vent limiter	Maxitrol #12A09 (used with pressure switches)	123481		

**Includes built-in vent limiter.

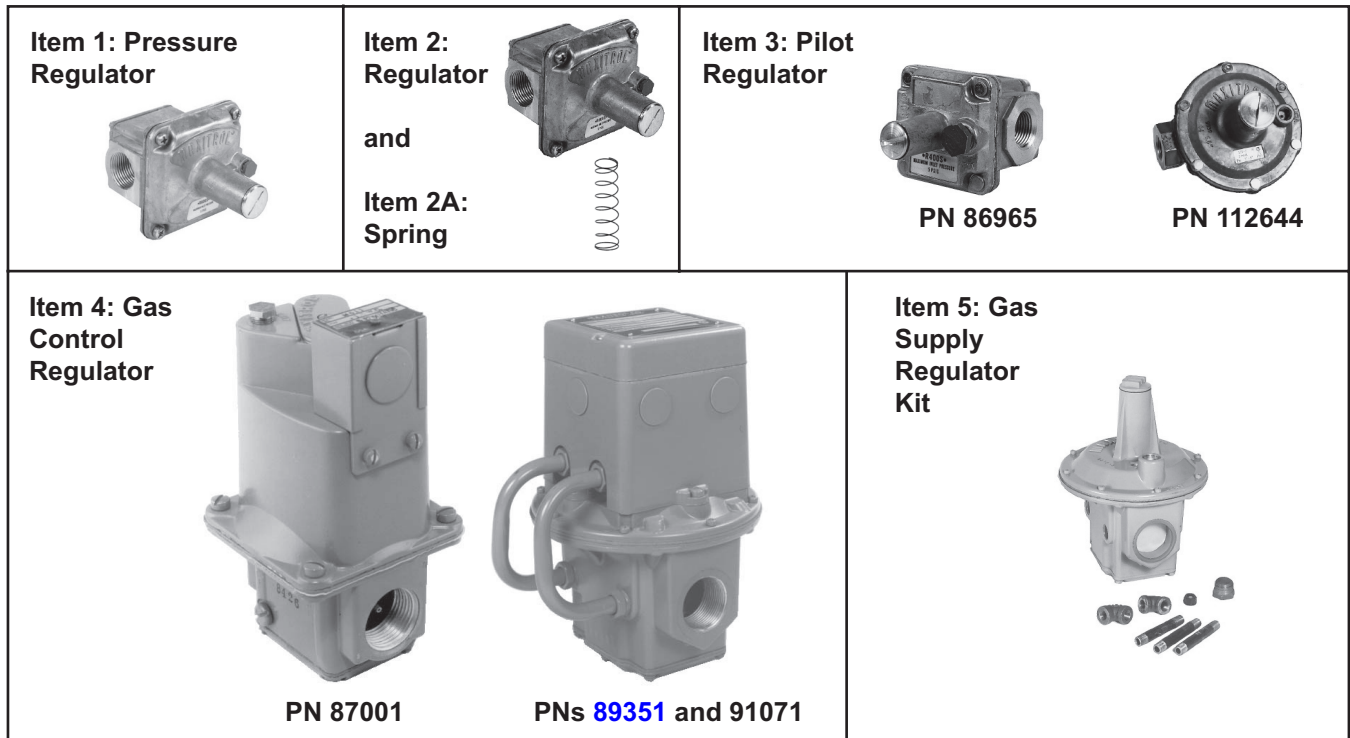

Figure 6. Gas Pressure Regulators (Refer to Table 17)

GAS REGULATORS, GAS VALVES, AND GAS PRESSURE SWITCHES—CONTINUED















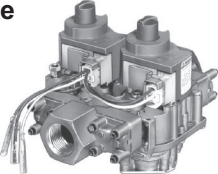

<p>Item 6: Pilot Valve</p>  <p style="text-align: center;">PN 86967</p>	 <p style="text-align: center;">PN 145733</p>	 <p style="text-align: center;">PN 204769</p>
<p>Item 7: Pilot Needle Valve</p> 	<p>Item 8: Pilot Needle Valve Conversion Kit</p>  <p style="text-align: center;">8A 8B 8C</p>	
<p>Item 9: Solenoid Valve</p>  <p style="text-align: center;">PN 86966</p>  <p style="text-align: center;">PN 146472</p>	<p>Item 10: Single-Stage Gas Valve</p> 	<p>Item 11: Air Controller</p> 
<p>Item 12: Two-Stage Gas Valve</p> 	<p>Item 13: Ductstat</p> 	<p>Item 14: Vent Valve</p> 
<p>Item 15: Valve</p>  <p style="text-align: center;">and</p> <p>Item 15A: Actuator</p> 	<p>Item 16: Gas Valve</p>  <p style="text-align: center;">and</p> <p>Adapter</p> 	<p>Item 17: Pilot Gas Valve</p> 

Figure 7. Gas Pressure Valves (Refer to Table 17)





<p>Item 19: Low Gas Pressure Switch</p>  <p style="text-align: center;">PN 204375</p>  <p style="text-align: center;">PN 93849</p>	<p>Item 20: High Gas Pressure Switch</p>  <p style="text-align: center;">PN 204297</p>  <p style="text-align: center;">PN 93850</p>	<p>Item 21: Vent Limiter</p> 
---	---	---

Figure 8. Gas Pressure Switches (Refer to Table 17)

MODULATING GAS CONTROL COMPONENTS

NOTE:

- When replacing a temperature sensor (item 1) on a Maxitrol MV-9 system (option AG33), check the model number on the sensor. PN 119617 or 194160 is used on units manufactured *after* JAN 1992. PN 87041 is used on units manufactured *before* FEB 1992.
- Sensors are not interchangeable and **MUST** match the amplifier.
- To replace the amplifier (item 3):
 - for PN **148590** (model A1014L or A1014U) or PN **86976**, order replacement kit PN **268301**;
 - for PN 194159 (model A1044CL), PN 157915 (model A1044EL), PN 119616 (model A1044E), or PN 86989 (model A1044), order replacement kit PN **268302**.
- Amplifiers are not interchangeable and **MUST** match the sensor.
- Modulating gas control components are listed in **Table 18** and shown in **Figure 9**.

Table 18. Modulating Gas Control Components

Item No.	Component	Description	PN	Gas Control Option	Serial No. Suffix	Location
1	Temperature sensor	Maxitrol series 14, #TS114	90324	AG30, AG31	MV-7	Discharge
		Maxitrol series 14A, #TS114A	87106	AG32	MV-8	
		Maxitrol series 14B, #TS114B	123944	AG35	MV-8	
		Maxitrol series 44, #TS144E, 120°F max	119617	AG33	MV-9	
		Maxitrol series 44, #TS144C, 140°F max	194160			
		Maxitrol series 94, #TS194	133228	AG36	MV-B	
2	Mixing tube	Maxitrol MTI-12	90323	AG30, AG31, AG32, AG33, AG35, AG36	MV-7, MV-8, MV-9, MV-B	
3	Amplifier	Maxitrol series 14 and 14A, #A1014R	148590	AG30, AG31, AG32	MV-7, MV-8	Electrical control compartment
		Maxitrol series 44, #A1044U (shown without cover)	268274	AG33	MV-9	
		Maxitrol series 94, A1494	133229	AG36	MV-B	
3A	Replacement kit	Amplifier, for PN 148590 (model A1014L or A1014U) or PN 86976	268301	AG30, AG31, AG32	MV-7, MV-8	
		Amplifier, for PN 194159 (model 1044CL), PN 157915 (model A1044EL), PN 119616 (model A1044E), or PN 86989 (model A1044)	268302	AG33	MV-9	
4	Signal conditioner	Maxitrol (for computer control)	134170	AG37	MV-C	
5	Temperature selector	Maxitrol series 14, #TD114, range 55–90°F, selector with box (PN 156085), US installations	86988	AG30, AG31	MV-7	Remote
		Maxitrol series 14, #TD114, range 50–75°F, Canadian installations	101165			
		Maxitrol series 14A, #TD114A, range 80–130°F	87107	AG32	MV-8	
		Maxitrol series 14B, #TD114B, range 120–160°F	159285	AG35	MV-8	
		Maxitrol series 14B, #TD114B, range 120–140°F	123943			
		Selectrastat, Maxitrol series 44, #T-244	86990	AG33	MV-9	Space
		Maxitrol series 94, #TD294E-609-0818, 120°F, dual selector for paint booth applications (option AG36)	133230	AG36	MV-B	Remote
Maxitrol series 94, #TD294E-609-0818, 160°F	159287					
6	Thermostat	Overriding, series 14, #T115	24857	AG31	MV-7, MV-8	Space

MODULATING GAS CONTROL COMPONENTS—CONTINUED

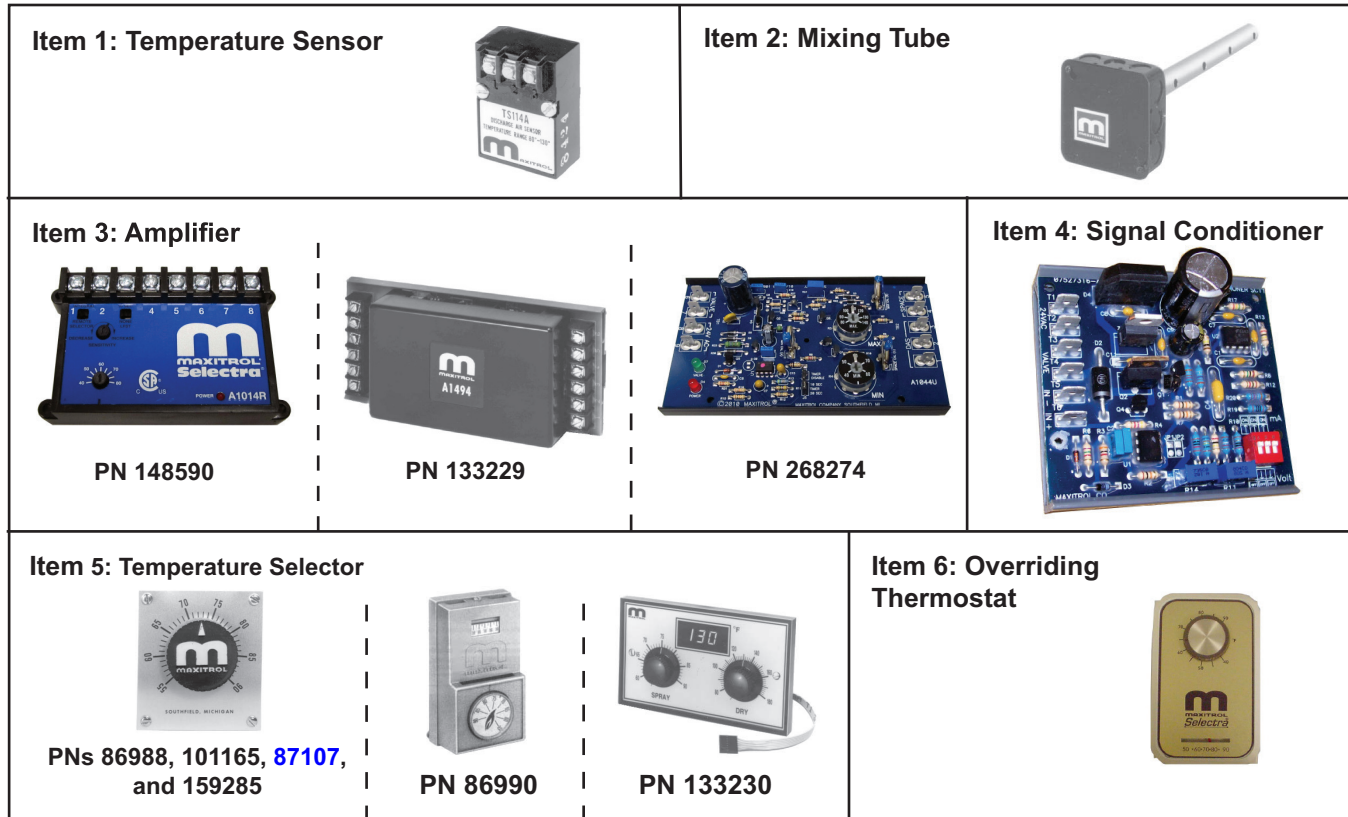

Figure 9. Modulating Gas Control Components (Refer to [Table 18](#))

IGNITION SYSTEM COMPONENTS

NOTE:

- The spark ignition system was discontinued in MAR 1996. at which point the ignition system was changed to a hot surface ignition system.
- Hot surface ignition components are listed in [Table 19](#) and shown in [Figure 10](#).
- Spark ignition components are listed in [Table 20](#) and shown in [Figure 11](#).

Table 19. Hot Surface Ignition System Components (Units Manufactured <i>After</i> FEB 1996)			
Item No.	Component	Description	PN
1	Ignition module (located in electrical control compartment)	RAM #H4MC24-01, serial No. ignition system code 72 (units manufactured from MAR 1996 through AUG 2003)	157953
		Synetek IH11040B-C, single-flame rod, serial No. ignition system code 82, used on series 3 units with burner sizes 250–1500 MBH (options BL1–BL6) (units manufactured <i>after</i> AUG 2003)	204376
		Synetek IH11040C-C, dual-flame rod, serial No. ignition system code 81, used on series 3 units with burner sizes 1750–3000 MBH (options BL7–BL13) (units manufactured <i>after</i> AUG 2003)	204166
2	Pilot assembly	For units manufactured <i>before</i> SEP 2003	120048
2A	Pilot		122840
2B	Flame sensor	J/C #Y75MK-1D	134706
2C	Screw	#8 × 1/2-inch long	38529
2D	Bushing	Pilot	121730
2E	Capscrew	Hex head, #10-32 × 3/8-inch long	90167
2F	Ignitor	Hot surface, Norton #401E	121865
3	Pilot	250–1500 MBH (units manufactured <i>after</i> AUG 2003)	127910
		1750–3000 MBH (units manufactured <i>after</i> AUG 2003)	122840
4	Ignitor	Hot surface, Norton #401E (units manufactured <i>after</i> AUG 2003)	121865
5	Flame sensor*	J/C #Y75MK-1D (units manufactured <i>after</i> AUG 2003)	134706
6	Ignition conversion kit** (not shown)	For unit with 200VA transformer	146268
		For 115V unit with 80VA transformer	146318
		For 208V, 240V, 480V, or 575V unit with 80VA transformer	146319

*For replacement of the flame sensor at the ignitor end of the burner only. 1750–3000 MBH burners have a second flame sensor (PN 210767).

**For converting to hot surface ignition from a spark pilot with either a rectification type or ultraviolet flame sensor.

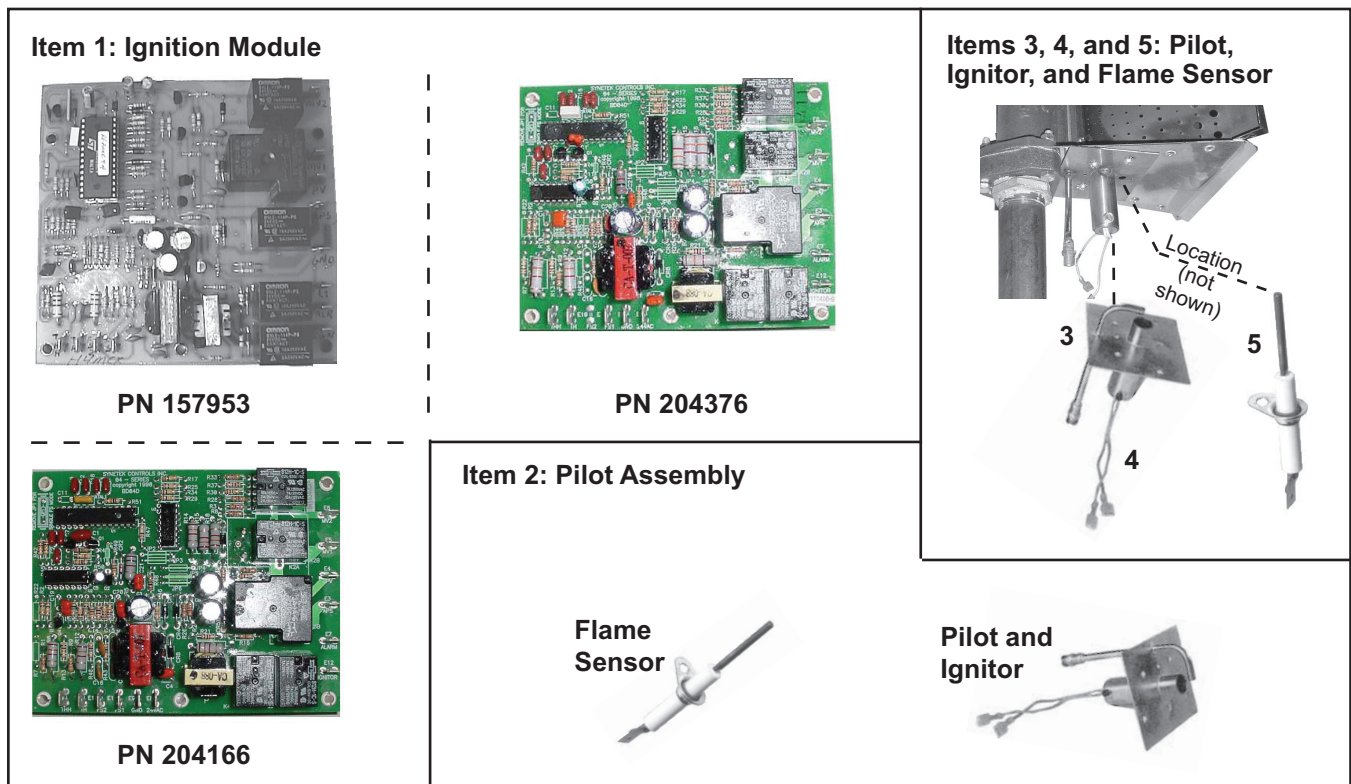

Figure 10. Hot Surface Ignition System Components—Units Manufactured *After* FEB 1996
(Refer to [Table 19](#))

IGNITION SYSTEM COMPONENTS—CONTINUED

Table 20. Spark Ignition System Components (Units Manufactured <i>Before</i> FEB 1996)			
Item No.	Component	Description	P/N
1	Safety relay	Flame sensor, rectification, Honeywell #RA890F1270, serial No. code 58 (used with item 3)	86972
		Flame sensor, ultraviolet, Honeywell #RA890G1310, serial No. code 59 (used with item 4)	89409
1A	Subbase	Honeywell #Q270A-1024	86973
2	Safety relay	Flame sensor, rectification, Honeywell #R7795B-1009 (used with item 3)	89407
		Flame sensor, ultraviolet, Honeywell #R7795A-1009 (used with item 4)	89436
2A	Subbase	Honeywell #Q795A-1004	89410
2B	Pre-purge relay	Timer board, M/H ST795A-1031	89408
3	Flame probe	Auburn #AA67-7892-1 (standard on units manufactured from AUG 1984 through AUG 1988)	87937
4	Ultraviolet detector	Minipeeper, Honeywell #C7027A (standard on units manufactured from SEP 1988 through FEB 1996, optional on prior units)	89411
5	Flame rod wire assembly	Models RDF 1-20, RDF 1-40, RDF 1-50, and RDF 1-65	87904
		Models RDF 2-80 and RDF 2-120	89614
		Models RDF 3-180 and RDF 3-260	113952
5A	Housing	AMP 1-48016-0	19127
6	Ignitor wire assembly	Models RDF 1-20, RDF 1-40, RDF 1-50, and RDF 1-65	87906
		Models RDF 2-80 and RDF 2-120	89627
		Models RDF 3-180 and RDF 3-260	91362
7	Spark plug	—	87936
		14 mm, Sapco #23539 (not shown)	179342

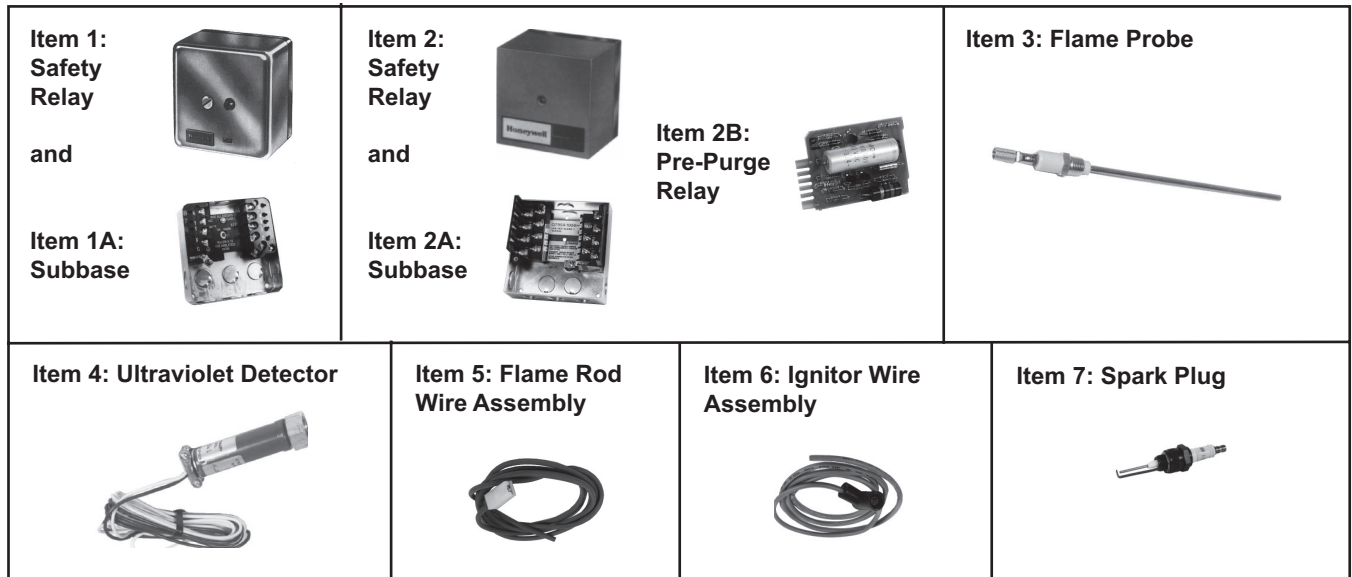

Figure 11. Spark Ignition System Components—Units Manufactured *Before* FEB 1996
(Refer to [Table 20](#))

BURNER COMPONENTS

NOTE:

- Units manufactured *after* AUG 2003 use Midco HMA-700 series burners, which include the burner, the mixing plates, and the end plate. 1,750–3,000 MBH (42- to 60-inch) burners also include a second sensor (PN 210767).
- Burner components for units manufactured *after* AUG 2003 are listed in Table 21 and shown in Figure 12.
- Burner components for units manufactured *before* SEP 2003 are listed in Table 22 and shown in Figure 13.

Table 21. Burner Components (Units Manufactured After AUG 2003)		
Component	Description	PN
Burner, Midco HMA-700 series (includes burner, mixing plates, and end plate)	6-inch, 250-MBH (option BL1)	203312
	12-inch, 500-MBH (option BL2)	203313
	18-inch, 750-MBH (option BL3)	203314
	24-inch, 1000-MBH (option BL4)	203315
	30-inch, 1250-MBH (option BL5)	203316
	36-inch, 1500-MBH (option BL6)	203317
	42-inch, 1750-MBH (option BL7)	203318
	42-inch, 2000-MBH (option BL8)	
	48-inch, 2250-MBH (option BL9)	203319
	54-inch, 2500-MBH (option BL10)	203320
	60-inch, 2750-MBH (option BL11)	203321
	60-inch, 3000-MBH (option BL12)	
Second sensor assembly	With bracket, used on 42- to 60-inch burners (at end of burner opposite ignitor)	210767
	Sensor only	210766

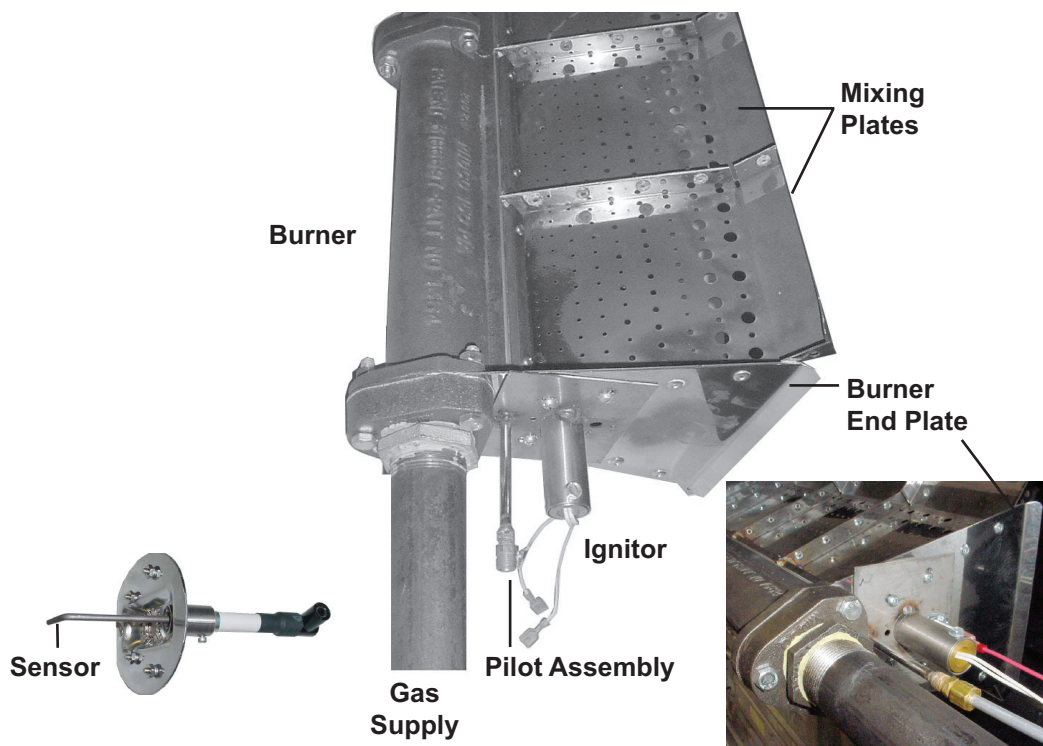

Figure 12. Burner Assembly—Units Manufactured After AUG 2003

BURNER COMPONENTS—CONTINUED

Component	Description	PN
Burner (includes cast iron burner and stainless steel mixing plates, does not include end plates, graphite paste, or hardware)	6-inch, 250-MBH (option BL1)	123405
	12-inch, 500-MBH (option BL2)	123665
	18-inch, 750-MBH (option BL3)	123684
	24-inch, 1000-MBH (option BL4)	123696
	30-inch, 1250-MBH (option BL5)	123700
	36-inch, 1500-MBH (option BL6)	145140
	42-inch, 1750-MBH (option BL7)	145159
	48-inch, 2000-MBH (option BL8)	145162
	54-inch, 2250-MBH (option BL9)	145169
	60-inch, 2500-MBH (option BL10)	145172
	66-inch, 2750-MBH (option BL11)	145175
	72-inch, 3000-MBH (option BL12)	145178
End plate	Burner, for hot surface ignition	95473
	Burner, for spark ignition	102957
Burner inlet flange	Must be sealed with key graphite paste (PN 146269)	123449
Mixing plate* (see below for quantities)	6-inch section, Maxon #20580	116104
Mixing Plate Quantities per Burner Size:	Burner Size (Inches)	Mixing Plate Quantity
	6	2
	12	4
	18	6
	24	8
	30	10
	36	12
	42	14
	48	16
	54	18
	60	20
66	22	
72	24	
*For all of the burners listed.		
NOTE: For instructions on burner servicing, refer to <i>Burner Cleaning</i> section in form O-ADF/RDF listed in Table 1 .		

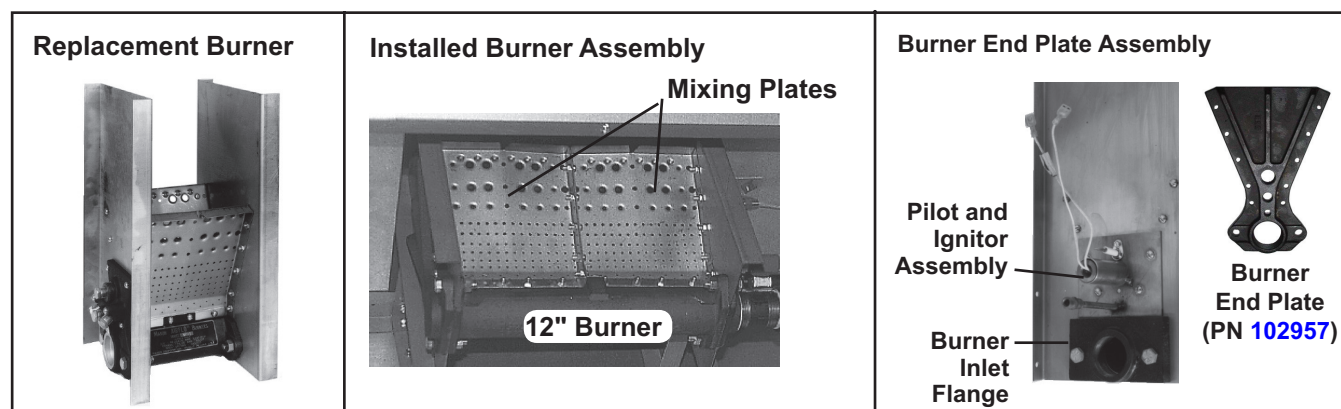

Figure 13. Burner Assembly—Units Manufactured *Before* SEP 2003

DAMPER COMPONENTS

NOTE:

- Damper locations are shown in [Figure 14](#).
- Damper components for units manufactured *after* AUG 2003 are listed in [Table 23](#) and shown in [Figure 15](#).
- Damper components for units manufactured *before* SEP 2003 are listed in [Table 24](#) and shown in [Figure 16](#).

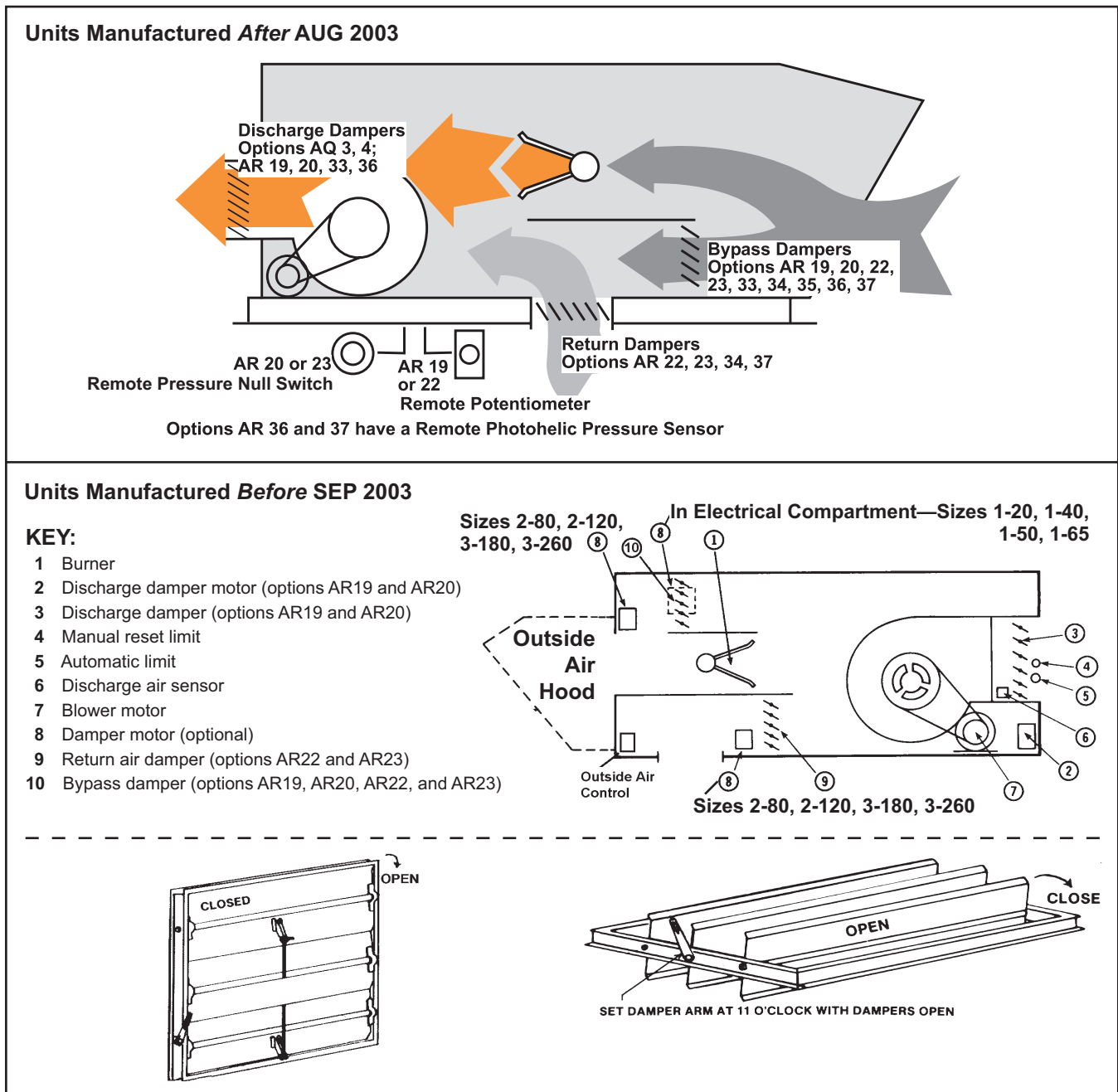

Figure 14. Damper and Damper Control Locations

DAMPER COMPONENTS—CONTINUED

Table 23. Damper Arrangements and Linkage Components (Units Manufactured <i>After</i> AUG 2003)								
Item No.	Component	Damper Arrangement	Description	Option	Model			
					RDF-1	RDF-2	RDF-3	
					PN (Quantity)*			
1	Damper (not shown)	Discharge	21-1/8 × 18-1/2 inches	AQ3, AQ4, AR19, AR20, AR33, AR36	15869	—		
			27-1/4 × 27-1/4 inches		—	89355	—	
			37 × 37 inches		—		91073	
		Return air	26 × 12 inches	AR22, AR23, AR34, AR37	203602	—		
		Bypass	53-1/2 × 17-3/4 inches	AR19, AR20, AR22, AR23, AR33, AR34, AR36, AR37		—		
		Return air		AR22, AR23, AR34, AR37	—	203604	—	
		Bypass	AR19, AR20, AR22, AR23, AR33, AR34, AR36, AR37	—				
Return air	65-3/4 × 20 inches	AR22, AR23, AR34, AR37	—	203603				
Bypass	AR19, AR20, AR22, AR23, AR33, AR34, AR36, AR37	—						
2	Motor	Discharge	Two-position, 100% makeup air, J/C #M9216-BGC-2	AQ3, AQ4	159892			
			Modulating, with manual potentiometer, J/C #M9216-JGA-2 (not shown)	AR19	204269			
		Discharge	Modulating, with automatic pressure switch, AF24-MFT95-US	AR20	159877			
		Return air		AR22	204271			
		Discharge	Modulating, with computer control through signal conditioner, J/C #M9216-GGC-2	AR33	204270			
		Return air		AR34	204270			
		Discharge	Modulating, with photohelic pressure sensor, J/C #M9109-AGA-2	AR36	204268			
Return air	AR37	204268						
Return air	Modulating, with automatic pressure switch, J/C #M9109-AGA-2	AR23	204268					
Bypass	Modulating, J/C #M9108-AGD-2	AR19, AR20, AR22, AR23, AR33, AR34, AR36, AR37	204268					
3	Damper rod (not shown)	Vertical discharge	1/4 × 16 inches (units manufactured <i>before</i> NOV 2007)	AQ3	112555	—		
		Horizontal discharge	1/4 × 16 inches (units manufactured <i>before</i> NOV 2007)	AQ4		—		
		Vertical discharge	1/4 × 7-1/2 inches	AQ3	—	89640		
		Horizontal discharge	1/4 × 38 inches	AQ4	—	89970	—	
		Horizontal discharge	1/4 × 24 inches		—	91428		
Return air	1/4 × 7-7/8 inches	AR34, AR37	5120	—				
4	Damper crank arm	Linkage	M/H #26026K	AR22, AR23, AR34	12635	—		
5	Damper crank arm kit	Linkage	M/H #26026K (units manufactured <i>before</i> NOV 2007)	AQ3, AQ4	12635			
			—	AQ3, AQ4	—	66278		
			—	AR34, AR37	66278	—		
			W/R #135-0002	AQ4	—	66277		
			J/C #9000-153	AR22, AR23	194200	—		
J/C #9000-153 (units manufactured <i>before</i> NOV 2007)	AQ3	194200						
6	Ball joint	Linkage	M/H #27518	AR19, AR20, AR22, AR23, AR34, AR37	12636 (2)	—		
			M/H #27518 (units manufactured <i>before</i> NOV 2007)	AQ3, AQ4	12636 (2)			

*Quantity is one (1) unless otherwise indicated.



Figure 15. Damper Components—Units Manufactured *After* AUG 2003 (Refer to [Table 23](#))

Item No.	Component	Damper Arrangement	Description	Option	Model		
					RDF-1	RDF-2	RDF-3
					PN (Quantity)*		
1	Damper	Discharge	22 × 18 inches	AQ3, AQ4, AR19, AR20	86999	—	
			28 × 28 inches		—	89355	—
			37 × 37 inches		—		91073
		Return	32 × 10 inches	AR22, AR23	87117	—	
		Bypass		AR19, AR20, AR22, AR23			
		Return	22 × 54 inches	AR22, AR23	—	89354	—
		Bypass		AR19, AR20, AR22, AR23			
Return	30 × 68 inches	AR22, AR23	—	—	91074		
Bypass		AR19, AR20, AR22, AR23					
2	Damper adjustment arm	Bypass	—	AR 22, 23	111309		
3	Motor	Discharge	Two-position, 100% makeup air, M/H #M8415A1004	AQ3, AQ4	87000	—	
			Two-position, 100% makeup air, W/R #3402-9		—	97385	
		Discharge	Modulating, with manual potentiometer, M/H #M9175A1015 (replaces PN 53928)	AR19	115681**		
		Return air		AR22			
		Discharge	Modulating, with photohelic pressure switch, M/H #M6414A1009	AR20	87116	—	
		Return air		AR23			
		Bypass		AR19, AR20, AR22, AR23			
Discharge	Modulating, with photohelic pressure switch, M/H #M6194B1011 (replaces PN 87059)	AR20	—	115683**			
Return air		AR23					
Bypass		AR19, AR20, AR22, AR23					

*Quantity is one (1) unless otherwise indicated.

**When installing replacement motors (PN 115681 or 115683) to replace PN 53928 or 87059, it is necessary to change the damper motor crank arm. Order PN 116209.

DAMPER COMPONENTS—CONTINUED

Table 24. Damper Arrangements and Linkage Components (Units Manufactured <i>Before</i> SEP 2003)—Continued								
Item No.	Component	Damper Arrangement	Description	Option	Model			
					RDF-1	RDF-2	RDF-3	
					PN (Quantity)*			
4	Damper rod† (not shown)	Vertical discharge	1/4 × 16 inches	AQ3	11560	—		
		Horizontal discharge		AQ4				
		Discharge		AR19, AR20				
		Return air		AR22, AR23				
		Horizontal discharge	1/4 × 38 inches	AQ4	—	89970	—	
		Horizontal discharge	1/4 × 24 inches	AQ4	—		91428	
		Discharge		AR19, AR20				
		Discharge	1/4 × 7-1/2 inches	AQ3	—	89640		
		Bypass		AR19, AR20, AR22, AR23	—		89640	
		Discharge	1/4 × 11 inches	AR19, AR20	—	14226	—	
		Return air		AR22, AR23	—		—	
		Bypass	1/4 × 7-7/8 inches	AR19, AR20, AR22, AR23	5120		—	
	1/4 × 5 inches	—			90056	—		
Return air	1/4 × 18-1/2 inches	AR22, AR23	—		91422			
5	Auxiliary end switch	Linkage	Used only on M/H damper motors, M/H #Q607B1067	—	113963			
6	Damper motor crank arm	Linkage	M/H #221455A	AR19, AR20, AR22, AR23	116209 (2)**			
			With clip, M/H #7616BR (used with obsolete motors)	—	20874			
7	Damper crank arm	Linkage	M/H #26026K	AR19, AR20, AR22, AR23	12635 (2)			
				AQ3, AQ4	12635			
8	Ball joint	Linkage	M/H #27518	AR19, AR20, AR22, AR23	12636 (4)			
				AQ3, AQ4	12636 (2)			

*Quantity is one (1) unless otherwise indicated.

**When installing replacement motors (PN 115681 or 115683) to replace PN 53928 or 87059, it is necessary to change the damper motor crank arm. Order PN 116209.

†Damper rods may require being cut to desired length.

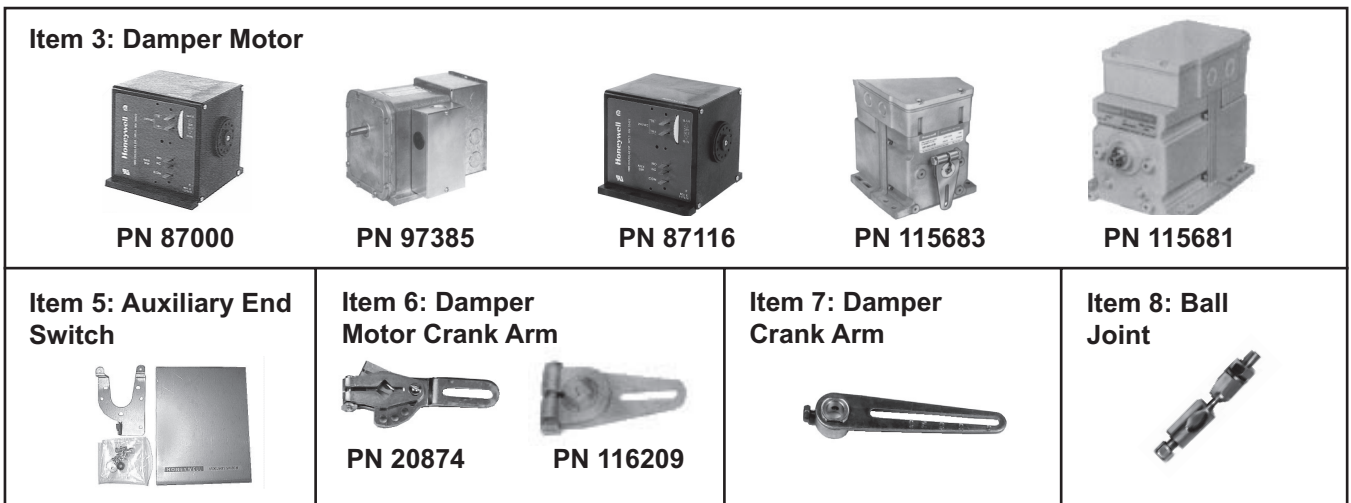

Figure 16. Damper Components—Units Manufactured *Before* AUG 2003 (Refer to Table 24)

BLOWER- AND MOTOR-MOUNTING COMPONENTS

Table 25. Blower- and Motor-Mounting Components										
Item No.	Component	Description	Model							
			1-20	1-40	1-50	1-65	2-80	2-120	3-180	3-260
			PN (Quantity)*							
1	Blower with shaft and bearings	10-inch, #A10-10AC	1357	—						
		12-inch, #A12-12AC	—	1360	—					
		15-inch, #A15-15A	—		86983	—				
		18-inch, class 1, 1-inch shaft, #A18-18A	—		86984	—				
		18-inch, class 1, 1-7/16-inch shaft, #022920-03	—		92343**		—			
		20-inch, class 1, 1-7/16-inch shaft, #027550-02 A20-20K	—		89345		—			
		22-inch, class 1, 1-7/16-inch shaft, #020350-01 A22-22K	—		91067		—			
		30-inch, class 1, 1-11/16-inch shaft, #029353-02 A30-22K	—		91069		—			
		18-inch, class 2, 1-7/16-inch, #0217142-15 A18-18A	—		89658		—			
		22-inch, class 2, 2-3/16-inch, #029353-01 A22-22K	—		91068		—			
		30-inch, class 2, 2-11/16-inch, #029353-03 A30-22K	—		91070		—			
1A	Blower shaft (class 1 blower)	3/4 x 22 inches	11302	—						
		1 x 22 inches	—	11303	—					
		1 x 23 inches	—		100747	—				
		1 x 28.8 inches	—		100748	—				
		2 x 28.8 inches	—		100748	—				
		1.44 x 37.25 inches	—		100746	—				
		1.44 x 45.73 inches	—		100751	—				
	1.69 x 46.25 inches	—		100754	—					
	Blower shaft (class 2 blower)	1.44 x 38.5 inches	—		100749	—				
		2.19 x 45.75 inches	—		100752	—				
2.69 x 46.25 inches		—		101705	—					
1B	Blower bearing (class 1 blower)	—	7310	—						
		Ball bearing	—	10437 (2)		—				
		1.44-inch, pillowblock	—		106942 (2)		—			
	Blower bearing (class 1 blower)	1.69-inch, pillowblock	—		100755 (2)		—			
		1.44-inch, pillowblock	—		106942 (2)		—			
		2.19-inch, pillowblock	—		100753 (2)		—			
2	Bearing plate (not shown)	External shaft support	—		111389		—			
		External shaft support†	—		126588††		—			
3	Bearing (not shown)	BF-1127-502-A†	111390							
4	Mounting plate	Blower motor†	12578		94371					
5		Motor mounting, left support	87015		94369					
6		Motor mounting, right support	87016		94369					
7	Blower support (not shown)	Horizontal discharge	207840		207461 (2)		207462 (3)			

*Quantity is one (1) unless otherwise indicated.

**As of AUG 1990, 2-80 models are no longer manufactured with a class 1 blower. PN 92343 is no longer available. Replace with a class 2 blower (PN 89658) and Q1 1-7/16-inch bushing (PN 16177).

†For units with damper option AQ3, AQ4, and/or AR19, AR20, AR22, AR23.

††Order PN 126588 when heater has option AR23—outside and return dampers controlled by a remote pressure sensor.

BLOWER- AND MOTOR-MOUNTING COMPONENTS—CONTINUED

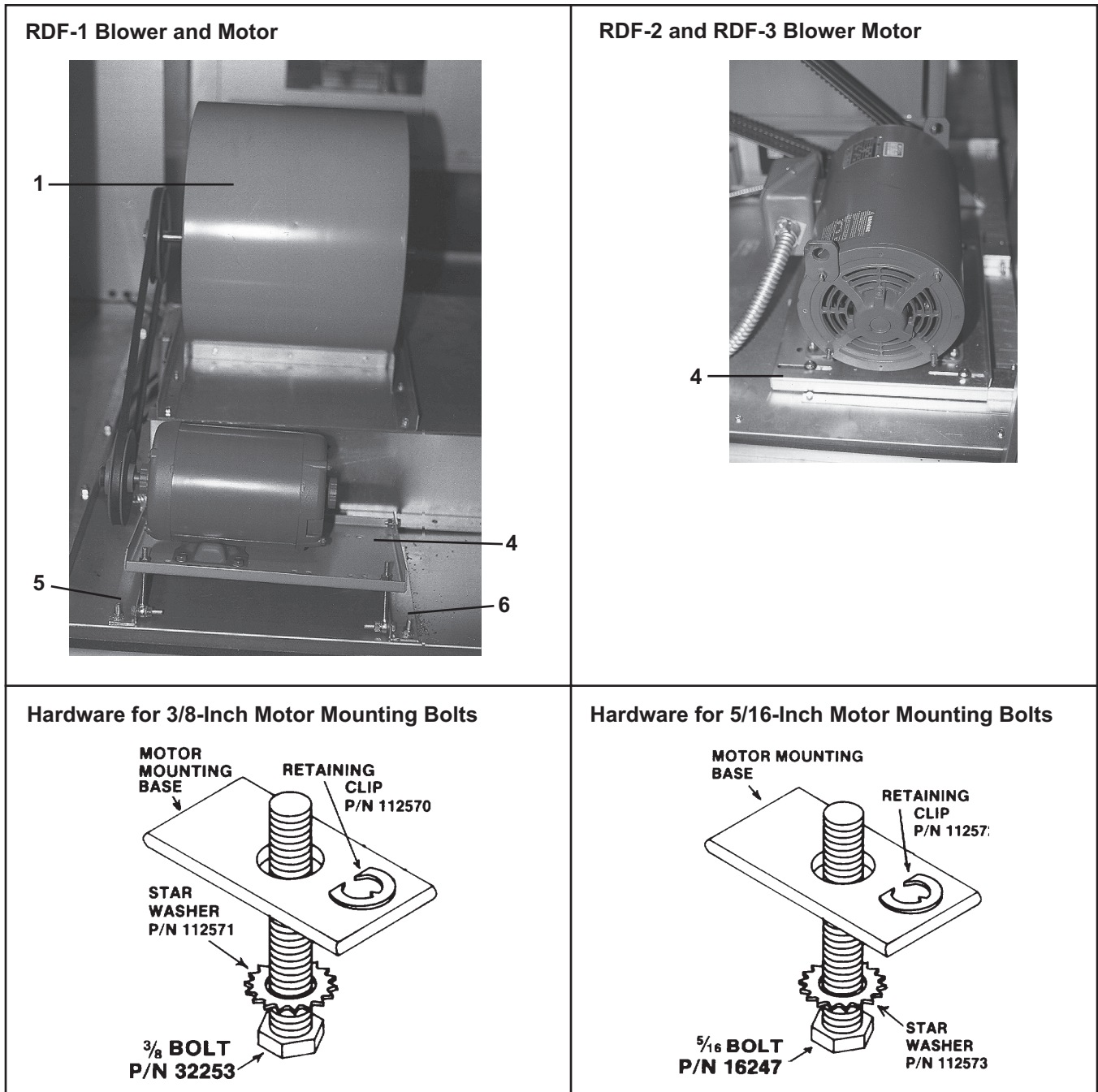

Figure 17. Blower- and Motor-Mounting Components (Refer to [Table 25](#))

DRIVE COMPONENTS

- **Belt Tension:** Check belt tension. Proper belt tension is important to ensure the long life of the belt and motor. A loose belt will cause wear and slippage. Too much tension will cause excessive motor and blower bearing wear. If adjustment is required, adjust belt tension by means of the adjusting screw on the motor base until the belt can be depressed 1/2- to 3/4-inch. Tighten the locknut on the adjusting screw and ensure that the belt is aligned in the pulleys.
- **Blower Speed Adjustment:** Units are factory-set for the RPMs required to meet the CFM and external static pressure specified on the order. If the estimated external static pressure is incorrect or if changes are made to the duct system, the blower RPM setting may have to be changed. Motors are equipped with adjustable pitch pulleys that permit blower speed adjustment.
- **For all model RDF-1 units and RDF-2 and RDF-3 units with less than 7.5-HP motor (units with a Browning motor sheave Model VP), adjust the blower speed as follows:**
 - a. Loosen belt tension and remove belt.
 - b. Loosen setscrew on side of pulley away from motor.
 - c. Turn adjustable half of pulley inward to increase blower speed or outward to decrease speed. One turn of pulley changes speed 8–10%.
 - d. After setting pulley, tighten setscrew on flat portion of pulley shaft.
 - e. Replace belts and adjust belt tension.
 - f. Always check motor amps using amp meter after RPM adjustment. Maximum motor amp rating on nameplate must not be exceeded.
- **For model RDF-2 and RDF-3 units with 7.5-HP and larger motors (units with adjustable Browning motor sheave Model MV), adjust the blower speed as follows:**
 - a. Loosen belt tension by moving motor toward driven shaft until belts are free of grooves. For easiest adjustment, remove belts from grooves.
 - b. On outer locking ring, locate two locking screws that are directly across from each other. Loosen screws but do not remove. Do not loosen any other screws.

⚠ CAUTION ⚠

Do not adjust sheaves in either direction to the point where moveable and stationary flanges are in contact.

- c. Adjust sheave to desired pitch diameter by turning outer locking ring. One complete turn of outer locking ring results in 0.233-inch change in pitch diameter. To **increase** blower speed, **decrease** diameter.
- d. After completing adjustment, tighten both locking screws in outer locking ring.
- e. Replace belts and move motor away from drive shaft to apply sufficient belt tension to prevent slippage. Ensure that belts are properly-aligned in pulley grooves and are not angled from pulley to pulley.
- f. Always check motor amps using amp meter after RPM adjustment. Maximum motor amp rating on nameplate must not be exceeded.

DRIVE COMPONENTS—CONTINUED

- **Blower Pulley:** Size 2-80, 2-120, 119, and 120 systems—equipped with 3- and 5-HP motors with a 15.4” diameter and larger blower pulley or a 7-1/2 HP and larger motor—and all size 3-180, 3-260, 122, and 130 systems are equipped with a split taper bushing in the blower pulley. The split taper bushings must be loosened in order to remove the pulley. Loosen the bushing as follows:
 - a. Note that there are three capscrews in the bushing and two holes—without screws—called push-off holes (see [Figure 18](#)). Remove capscrews.
 - b. Install two capscrews removed in step a into push-off holes. Tighten capscrews evenly until pulley is loosened.
 - c. Remove pulley from shaft.

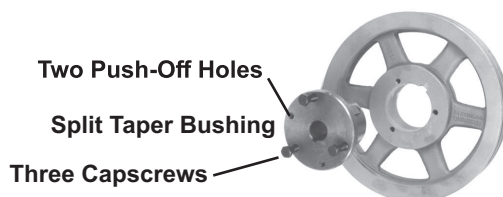

Figure 18. Blower Pulley Removal

NOTE:

- [Table 26](#) lists the RPM range for each drive option.
 - Replacement drive components are as follows: motor sheave, blower sheave, belt, and bushing. They are listed in [Table 27](#), [Table 28](#), [Table 29](#), [Table 30](#), [Table 31](#), [Table 32](#), [Table 33](#), [Table 34](#), [Table 35](#), and [Table 36](#) by unit size, motor type, HP, and RPM, and by drive (AM) option.
 - Where option AK8 (575V) is listed in [Table 27](#), [Table 28](#), [Table 29](#), and [Table 30](#) the AL options above apply to all other voltages with that HP.
 - Read each drive table carefully. They are not all in the same format.
-

Table 26. Range (RPM) by Drive Option

Drive Option	Range (RPM)	Drive Option	Range (RPM)
AMA3	301–350	AM13	1001–1050
AMA4	351–400	AM14	1051–1100
AM1	401–450	AM15	1101–1150
AM2	451–500	AM16	1151–1200
AM3	501–550	AM17	1201–1250
AM4	551–600	AM18	1251–1300
AM5	601–650	AM19	1301–1350
AM6	651–700	AM20	1351–1400
AM7	701–750	AM21	1401–1450
AM8	751–800	AM22	1451–1500
AM9	801–850	AM23	1501–1550
AM10	851–900	AM24	1551–1600
AM11	901–950	AM25	1601–1650
AM12	951–1000	AM26	1651–1700

Table 27. Drive Components for Unit Size 1-20 with Open-Type Motor

HP	Option	Dschg*	Drive (AM) Option**	Motor Sheave			Blower Sheave			Belt		Bushing PN	
				MFR's Model	Bore Size (Inches)	PN	MFR's Model	Bore Size (Inches)	PN	MFR's Model	PN		
1/2	AL4	V	6-9	1VL40	5/8	7962	AK74	3/4	111607	A52	50513	—	
		H								A43	50470		
		V	10-15				AK54		105480	A49	50475		
		H								A39	105493		
3/4	AL5	V	8-11	1VL44	5/8	105476	AK71	3/4	111682	A52	50513		
		H								A43	50470		
		V	12-16	1VL40		105476	AK59		105479	A48	65403		
		H		1VL44						111684	A41		50500
		V	17-21	1VM50		13013	AK54		105480	A50	88558		
		H								A41	50500		
1	AL6	V	10-15	1VL40	5/8	7962	AK54	3/4	105480	A49	50475		
		H								A39	105493		
	AL6 (AK8)	V			7/8	106748				AK59	111684	A49	50475
		H										A39	105493
	AL6	16-20	1VM50	5/8	13013	AK59	111684		A51	65404			
									H	A39	105493		
	AL6 (AK8)			V	7/8		37451		AK59	111684	A39	105493	
				H							A51	65404	
1-1/2	AL7	V	10-15	1VL40	5/8	7962	AK54	3/4	105480	A49	50475		
		H								A39	105493		
	AL7 (AK8)	V			7/8	106748				AK59	111684	A49	50475
		H										A39	105493
	AL7	16-20	1VM50	5/8	13013	AK59	111684		A51	65404			
									H	A39	105493		
	AL7 (AK8)			V	7/8		37451		AK59	111684	A39	105493	
				H							A51	65404	
	AL7	21-24	1VL40	5/8	7962	AK41	105478		A47	50474			
									H	1VP56	16151	AK56H	110807
AL7 (AK8)	V			1VL40	7/8		106748	AK41	105478	A47	50474		
	H									A42	101412		
2†	AL8	V	15-20	1VM50	7/8	37451	AK59	3/4	111684	A51	65404		
		H								A39	105493		
		V	21-24	1VL40		106748	AK41		105478	A47	50474		
		H								A42	101412		
2††	AL8	V	15-20	1VM50	5/8	13013	AK59	3/4	111684	A51	65404		
		H								A39	105493		
		V	21-24	1VL40		7962	AK41		105478	A47	50474		
		H								1VP56	16151	AK41	105478

*H = horizontal discharge. V = vertical discharge.

**Refer to Table 26.

†Units manufactured *after* AUG 2003.

††Units manufactured *before* SEP 2003.

DRIVE COMPONENTS—CONTINUED

Table 28. Drive Components for Unit Size 1-40 with Open-Type Motor

HP	Option	Dschg*	Drive (AM) Option**	Motor Sheave			Blower Sheave			Belt															
				MFR's Model	Bore Size (Inches)	PN	MFR's Model	Bore Size (Inches)	PN	MFR's Model	PN														
3/4	AL5	V	4-6	1VL40	5/8	7962	AK84	1	19111	A53	50513														
		H								A46	50473														
		V	7-11							1VL44	7/8	105476	AK56	105482	A49	50475									
		H													A42	101412									
		V	12-17												1VL44	7/8	105476	AK56	105482	A49	50475				
		H																		A42	101412				
1	AL6	V	7-11	1VL40	5/8	7962	AK64	1	18797											A49	50475				
		H																		A42	101412				
	V	AL6 (AK8)								1VL40	7/8	106748	AK64	1						18797	A49	50475			
	H																				A42	101412			
	V	12-17	1VL44												5/8	105476	AK56	105482	A49		50475				
	H																		A42		101412				
	V			AL6 (AK8)	1VL44	7/8	106758	AK56	105482										A49		50475				
	H																		A42		101412				
	1-1/2	AL7		V						7-11	1VL40	5/8	7962	AK64					1	18797	A49	50475			
				H																	A42	101412			
		V	AL7 (AK8)	1VL40											7/8	106748	AK64	1			18797	A49	50475		
		H																				A42	101412		
V		12-17	1VL44		5/8	105476	AK56	105482	A49	50475															
H									A42	101412															
V									AL7 (AK8)	1VL44	7/8	106758	AK56	105482					A49	50475					
H																			A42	101412					
V		18-21		1VM50					5/8						13013	AK56	105482	A49	50475						
H																		A43	50470						
V			AL7 (AK8)		1VM50	7/8	37451	AK56										105482	A49	50475					
H																			A43	50470					
2†	AL8	V	7-11							1VL40	7/8	106748	AK64	1					18797	A49	50475				
		H																		A42	101412				
		V	12-17	1VL40					7/8						106748	AK56	105482			A49	50475				
		H																		A42	101412				
		V	18-21		1VM50	5/8	37451	AK56										105482		A49	50475				
		H																		A43	50470				
2††	AL8	V								7-11	1VL40	5/8	7962	AK64					1	18797	A49	50475			
		H																			A42	101412			
		V	12-17	1VL44					5/8	105476					AK56	105482	A49				50475				
		H															A42				101412				
		V	18-21		1VM50	5/8	13013	AK56									105482	A49			50475				
		H																A43			50470				
	3	AL9									V	12-17	1VL40	7/8				106748	AK99	1	111609	A55	16132		
											H											A48	65403		
			V	18-21					1VL40	7/8	106748	AK84			1	19111			A52		50513				
			H																A46		50473				
			5		AL10	V	14-18	2VP50									7/8		8973		2AK124	1	30621	A60	50477
						H																		A54	16131
V	19-23	2VP50		7/8		8973	2AK104					1	7955	A57		16134									
H														A50		88558									

*H = horizontal discharge. V = vertical discharge.

**Refer to [Table 26](#).

†Units manufactured *after* AUG 2003.

††Units manufactured *before* SEP 2003.

Table 29. Drive Components for Unit Size 1-50 with Open-Type Motor

HP	Option	Dschg*	Drive (AM) Option**	Motor Sheave			Blower Sheave			Belt							
				MFR's Model	Bore Size (Inches)	PN	MFR's Model	Bore Size (Inches)	PN	MFR's Model	PN						
1	AL6	V	4-6	1VL40	5/8	7962	AK84	1	19111	A50	88558						
		H								A46	50473						
	AL6 (AK8)	V								7-11	1VL40	5/8	7962	AK64	18797	A50	88558
		H														A46	50473
	AL6	V	7-11	1VL40	5/8	7962	AK64	1	18797	A47	50474						
		H								A42	101412						
	AL6 (AK8)	V	7-11	1VL40	7/8	106748	AK64	1	18797	A47	50474						
		H								A42	101412						
1-1/2	AL7	V	4-6	1VL40	5/8	7962	AK84	1	19111	A50	88558						
		H								A46	50473						
	AL7 (AK8)	V								7-11	1VL40	5/8	7962	AK64	18797	A50	88558
		H														A46	50473
	AL7	V	7-11	1VL40	5/8	7962	AK64	1	18797	A47	50474						
		H								A42	101412						
	AL7 (AK8)	V	7-11	1VL40	7/8	106748	AK64	1	18797	A47	50474						
		H								A42	101412						
2†	AL8	V	4-6	1VL40	7/8	106748	AK84	1	19111	A50	88558						
		H								A46	50473						
		AL8	V				7-11			1VL40	7/8	106748	AK64	18797	A47	50474	
			H												A42	101412	
2††	AL8	V	4-6	1VL40	5/8	7962	AK84	1	19111	A50	88558						
		H								A46	50473						
		AL8	V				7-11			1VL40	5/8	7962	AK64	18797	A47	50474	
			H												A42	101412	
3	AL9	V	8-11	1VL44	7/8	106758	AK144	1	113372	A61	88560						
		H								A58	50476						
		AL9	V	12-16		1VM50	37451			AK134	50520	A60	50477				
			H									A56	16133				
5	AL10	V	8-13	2VP36	7/8	87500	2AK104	1	7955	A53	16130						
		H								A49	50475						
		AL10	V	14-18		2VP50	8973			2AK124	30621	A58	50476				
			H									A54	16131				

*H = horizontal discharge. V = vertical discharge.

**Refer to [Table 26](#).

†Units manufactured **after** AUG 2003.

††Units manufactured **before** SEP 2003.

DRIVE COMPONENTS—CONTINUED

Table 30. Drive Components for Unit Size 1-65 with Open-Type Motor																									
HP	Option	Dschg ⁺	Drive (AM) Option ^{**}	Motor Sheave			Blower Sheave			Belt		Bushing PN													
				MFR's Model	Bore Size (Inches)	PN	MFR's Model	Bore Size (Inches)	PN	MFR's Model	PN														
1-1/2	AL7	V	2-3	1VM50	5/8	13013	AK144	1	113372	A61	88560	—													
		H								A59	92402														
	AL7 (AK8)	V	4-6							1VL40	7/8		37451	AK84	1	19111	A61	88560							
		H															A59	92403							
	AL7	V	4-6														1VL40	5/8	7962	AK84	1	19111	A49	50475	
		H																					A46	50473	
	AL7 (AK8)	V	4-6	1VL40	7/8	106748	AK84	1	19111														A49	50475	
		H																					A46	50473	
	AL7	V	7-11							1VL40	5/8		7962	AK64	1	18797							A45	50472	
		H																					A43	50470	
	AL7 (AK8)	V															7-11	1VL40	7/8	106748	AK64	1	18797	A45	50472
		H																						A43	50470
2 [†]	AL8	V		2-3	1VM50 1VL40	7/8	37451	AK144	1			113372												A61	88560
		H																						A59	92403
		V	4-6	1VM50 1VL40						7/8	106748		AK84	1	19111	A49								50475	
																H								A46	50473
		V	7-11													1VM50 1VL40	7/8	106748	AK64	1	18797	A45	50472		
																						H	A43	50470	
2 ^{††}	AL8	V	2-3		1VM50	5/8	13013	AK144	1			113372										A61	88560		
		H																				A59	92403		
		V	4-6	1VL40						5/8	7962		AK84	1	19111							A49	50475		
																						H	A46	50473	
		V	7-11													1VL40	5/8	7962	AK64	1	18797	A45	50472		
																						H	A43	50470	
3	AL9	V	4-7		2VP36	7/8	87500	AK144	1			113382										A59	92402		
		H																				A58	50476		
		V	8-11	2VP42	7/8		6599	2AK134H		1	30622	A58	50476												
												H	A56	16133											
5	AL10	V	7-13	2VP36		7/8	87500	2AK104	1		7955	A51	65404												
		H										A50	88558												

*H = horizontal discharge. V = vertical discharge.

**Refer to [Table 26](#).

[†]Units manufactured *after* AUG 2003.

^{††}Units manufactured *before* SEP 2003.

Table 31. Drive Components for Unit Size 2-80 with Open-Type Motor and Class 2 Blower

HP	Option	Dschg*	Drive (AM) Option**	Motor Sheave			Blower Sheave			Belt		Bushing PN
				MFR's Model	Bore Size (IN)	PN	MFR's Model	Bore Size (IN)	PN	MFR's Model	PN (Quantity)	
2†	AL8	V	3-5	1VL40	7/8	106748	BK110H	1-7/16	114026	B55	112531 (1)	89659
		H								B53	92222 (1)	
2††	AL8	V	3-5	1VL40	5/8	7962	BK110H	1-7/16	114026	B55	112531 (1)	
		H								B53	92222 (1)	
3	AL9	V	3-4	2VP36	7/8	87500	2AK184H	1-7/16	114027	A69	16558 (2)	
		H								A67	16139 (2)	
		V	5-9	1VP34		110125	AK134H		114028	A59	92402 (1)	
		H								A57	16134 (1)	
		V	10-13	1VL40		106748	AK124H		114030	A59	92402 (1)	
		H								A55	16132 (1)	
5	AL10	V	3-4	2VP36	7/8	87500	2AK184H	1-7/16	114027	A69	16558 (2)	
		H								A67	16139 (2)	
		V	5-6	2VP42		6599	2AK184H		114032	BX65	92276 (2)	
		H								A67	16139 (2)	
		V	7-11	2VP36		87500	2AK124H		114034	A58	50476 (2)	
		H								A55	16132 (2)	
7-1/2	AL11	V	6-7	2VP68	1-3/8	113802	2BK160H	1-7/16	89651	B66	114104 (2)	
		H		2VP71		114249				B64	92414 (2)	
		V	8-9	2VP60	106257	2BK120H	113811		B58	92226 (2)		
		H							B56	92224 (2)		
		V	10-11	2VP62	1-3/8	16150	2BV110		114045	BX59	92280 (2)	
		H								BX55	92409 (2)	
V	12-15	2VP60	106257	2BK90H	113804	B53	92222 (2)					
H						B51	92220 (2)					
10	AL12	V	6-7	2VP68	1-3/8	113802	2BK160H	1-7/16	89651	B66	114104 (2)	
		H		2VP71		114249				B64	92414 (2)	
		V	8-9	2VP60	106257	2BK120H	113811		B58	92226 (2)		
		H							B56	92224 (2)		
		V	10-11	2VP62	16150	2BV110	114045		BX59	92280 (2)		
		H							BX55	92409 (2)		
V	12-15	2VP60	106257	2BK90H	113804	B53	92222 (2)					
H						B51	92220 (2)					
15	AL15	V	7-9	2MVP40B54	1-5/8	91615	2BK120H	1-7/16	113811	BX55	92409 (2)	
		H		2VP71A		113809	2BK140H		92204	B59	16143 (2)	
		V	10-11				2MVP45B59		114047	2B5V86	89650	B58
		H		12-16		2VP75					113808	2B5V86
		V	17-20				2VP75		113808	2B5V86		
		H		B49		113805 (2)						
V	17-20	2VP75	113808	2B5V86	114048	BX53	114341 (2)					
H						BX51	92237 (2)					

*H = horizontal discharge. V = vertical discharge.

**Refer to Table 26.

†Units manufactured *after* AUG 2003.

††Units manufactured *before* SEP 2003.

Table 32. Drive Components for Unit Size 2-80 with TEFC-Type Motor and Class 2 Blower

HP	Option	Dschg*	Drive (AM) Option**	Motor Sheave			Blower Sheave			Belt		Bushing PN
				MFR's Model	Bore Size (IN)	PN	MFR's Model	Bore Size (IN)	PN	MFR's Model	PN (Quantity)	
5	AL27	H	7-9	1VP50	1-1/8	111681	AK184H	1-7/16	113799	A67	16139 (2)	89659

*H = horizontal discharge. V = vertical discharge.

**Refer to Table 26.

NOTE: If drive components are required for units with a TEFC motor not listed here, contact your Distributor or the Factory Service Department. Be prepared to provide complete model and serial No.

DRIVE COMPONENTS—CONTINUED

Table 33. Drive Components for Unit Size 2-80 with Class 1 Blower															
Motor		Dschg*	Drive (AM) Option**	Blower Range (RPM)	Motor Sheave			Blower Sheave		1-Inch Blower Bushing		Belt			
HP	Option				MFR's Model	Bore Size (Inches)	PN	MFR's Model	PN	Size Code	PN	MFR's Model	PN (Quantity)		
2	AL8	H	3	501-550	1VP50	5/8	13013	AK134	92416	H	92203	A59	92402 (1)		
		V										A77	80838 (1)		
		H	4	551-600								AK124	92417	A57	16134 (1)
		V										AK114	92418	A76	92403 (1)
		H	5	601-650								A56	16133 (1)		
V	A74	92404 (1)													
3, 5	AL9, AL10	H	3	501-550	2VP42	1-1/8	7963	2TB200	91621	Q	6605	A72	80839 (2)		
		V										A89	92406 (2)		
		H	4	551-600								2TB184	92208	A69	16558 (2)
		V												A86	92219 (2)
		H	5	601-650								2TB154	92206	A69	16558 (2)
		V						A86	92219 (2)						
		H	6	651-700				2BK140	92204	A63	16138 (2)				
		V								A81	92217 (2)				
		H	7	701-750				2BK130	89650	A63	16138 (2)				
		V								A81	92217 (2)				
		H	8	751-800				2BK130	89650	A59	92402 (2)				
		V								A77	80838 (2)				
		H	9	801-850				2BK130	89650	A59	92402 (2)				
		V								A77	80838 (2)				
		H	10	851-900				2BK130	89650	A57	16134 (2)				
V	A76	92403 (2)													
H	11	901-950	2BK130	89650	A57	16134 (2)									
V					A76	92403 (2)									
7.5	AL11	H	6	651-700	2MVP40B546	1-3/8	89641	2TB124	39458	Q	6605	B60	7972 (2)		
		V										B78	92234 (2)		
		H	7	701-750								2TB110	91631	B57	92225 (2)
		V												B76	92232 (2)
		H	8	751-800								2TB94	91632	B57	92225 (2)
		V						B76	92232 (2)						
		H	9	801-850				2TB86	91633	B54	92223 (2)				
		V								B73	92230 (2)				
		H	10	851-900				2TB86	91633	B54	92223 (2)				
		V								B73	92230 (2)				
		H	11	901-950				2TB74	92205	B53	92222 (2)				
		V								B71	92229 (2)				
		H	12	951-1000				2TB74	92205	B53	92222 (2)				
V	B71	92229 (2)													
H	13	1001-1050	2TB74	92205	B51	92220 (2)									
V					B70	92228 (2)									
10	AL12	H	7	701-750	2MVP40B546	1-3/8	89641	2TB110	91631	Q	6605	B57	92225 (2)		
		V										B76	92232 (2)		
		H	8	751-800								B57	92225 (2)		
		V										B76	92232 (2)		

*H = horizontal discharge. V = vertical discharge.

**Refer to [Table 26](#).

NOTE: As of AUG 1990, 2-80 models are equipped with a class 2 blower, which was previously an option on 2-80 models.

Table 34. Drive Components for Unit Size 2-120 with Open-Type Motor

HP	Option	Dschg*	Drive (AM) Option**	Motor Sheave			Blower Sheave			Belt		Bushing PN	
				MFR's Model	Bore Size (IN)	PN	MFR's Model	Bore Size (IN)	PN	MFR's Model	PN (Quantity)		
2†	AL8	V	3-5	1VL44	7/8	106758	AK104H	1-7/16	113798	A53	16130 (1)	89659	
		H		1VL40			BK110H		114026	B54	92223 (1)		
2††		V		1VL44	5/8	105476	AK104H		113798	A53	16130 (1)		
		H		1VL40	7962	BK110H	114026		B54	92223 (1)			
3	AL9	V	3-4	2VP36	7/8	87500	2BK10H	1-7/16	89652	BX68	92241 (2)		
		H					2AK184H		114027	A69	16558 (2)		
		V	5-7	1VL44			106758		AK184H	113799	A69		16558 (1)
				H			1VP34		110125	AK134H	114028		A59
		V	8-11	1VL44			106758		AK144H	113800	A61		88560 (1)
											H		A63
5	AL10	V	3-4	2VP36	7/8	87500	2BK10H	1-7/16	89652	BX68	92241 (2)		
		H					2AK184H		114027	A69	16558 (2)		
		V	5-7	2VP42			6599		BK160H	89651	BX62	92411 (2)	
									H	2AK184H	114027	A70	114257 (2)
		V	8-11	2VP36			87500		2AK104H	113801	A53	16130 (2)	
									H	2AK124H	114034	A57	16134 (2)
7-1/2	AL11	V	4-5	2VP65	1-3/8	110771	2B5V160	1-7/16	114032	BX64	114258 (2)		
		H					BX67			80841 (2)			
		V	6-7	2VP68			113802		2BK160H	89651	BX63	92278 (2)	
				H			2VP71		114249	B66	114104 (2)		
		V	8-11	2VP60			106257		2BK110H	113803	B54	92223 (2)	
									H	B56	92224 (2)		
		V	12-15	2VP60			106257		2BK90H	113804	B50	114010 (2)	
									H	B53	92222 (2)		
10	AL12	V	4-5	2VP65	1-3/8	110771	2B5V160	1-7/16	114032	BX64	114258 (2)		
		H					BX67			80841 (2)			
		V	6-7	2VP68			113802		2BK160H	89651	BX63	92278 (2)	
				H			2VP71		114249	B66	114104 (2)		
		V	8-11	2VP60			106257		2BK110H	113803	B54	92223 (2)	
									H	B56	92224 (2)		
		V	12-15	2VP60			106257		2BK90H	113804	B50	114010 (2)	
									H	B53	92222 (2)		
15	AL15	V	6-7	2VP75	1-5/8	113808	2B5V160	1-7/16	114032	BX62	92411 (2)		
		H		2MVP40B54		91615	2BK120H		113811	BX55	92409 (2)		
		V	8-9	2VP71A		113809	2BK140H		92204	B58	92226 (2)		
				H		2MVP40B54	91615		2BK120H	113811	BX55	92409 (2)	
		V	10-11	2VP75		113808	2BK130H		89650	B56	92224 (2)		
				H		2VP71A				113809	B59	16143 (2)	
		V	12-13	2VP75		113808	2BK120H		113811	B55	112531 (2)		
										H	B58	92226 (2)	

*H = horizontal discharge. V = vertical discharge.

**Refer to [Table 26](#).

†Units manufactured **after** AUG 2003.

††Units manufactured **before** SEP 2003.

NOTE: If drive components are required for units with a 3- to 10-HP TEFC or 3- to 10-HP premium-efficiency (EE) motor, contact your Distributor or the Factory Service Department. Be prepared to provide complete model and serial No.

DRIVE COMPONENTS—CONTINUED

Table 35. Drive Components for Unit Size 3-180 with Open-Type Motor												
HP	Option	Dschg*	Drive (AM) Option**	Motor Sheave			Blower Sheave			Belt		Bushing PN
				MFR's Model	Bore Size (IN)	PN	MFR's Model	Bore Size (IN)	PN	MFR's Model	PN (Quantity)	
Units with Class 1 Blower												
5	AL10	V	2-3	2VP42	7/8	6599	2B5V250	1-7/16	115718	BX97	92319 (2)	114033
		H								B92	92308 (2)	
		V	4-5	2VP36		87500	2BK190H		89652	B86	92312 (2)	89659
		H								BX77	92341 (2)	
7-1/2, 10	AL11, AL12	V	1	2VP71	1-3/8	114249	2B5V250	1-7/16	115718	BX99	115932 (2)	114033
		H								BX93	92313 (2)	
		V	2	2VP60		106257	2BK190H		89652	B88	115933 (2)	89659
		H								BX79	92322 (2)	
		V	3	2VP62		16150	2BK190H		89652	B89	115934 (2)	89659
		H								BX79	92322 (2)	
		V	4-5	2VP65		110771	2B5V160		114032	B84	92273 (2)	114033
		H								BX75	92277 (2)	
		V	6-7	2VP71		114249	2B5V160		114032	BX85	92317 (2)	114033
		H								2BK160H	89651	
		V	8-9	2VP60		106257	2BK120H		113811	BX75	92277 (2)	89659
		H								BX66	92240 (2)	
15, 20	AL15, AL16	V	4-5	3MVP40B54	1-5/8	89644	3B5V136	1-7/16	115720	BX77	92341 (3)	114033
		H								BX68		
		V	6-7	3MVP50B64		115719	3B5V154		115721	BX81	92274 (3)	114033
		H								B73	92230 (3)	
		V	8-10	3MVP45B59		89645	3BK120H		115722	B74	92231 (3)	89659
		H								B65	6010 (3)	
		V	11-14	3MVP40B54		89644	3BK90H		115723	BX68	92241 (3)	89659
		H								B59	16143 (3)	
Units with Class 2 Blower												
15, 20	AL15, AL16	V	2-3	3MVP45B59	1-5/8	89645	3B5V184	2-3/16	115943	B87	92310 (3)	116205
		H								B78	92234 (3)	
		V	4-6	3MVP40B54		89644	3B5V136		115720	BX77	92341 (3)	
		H								BX68		
		V	7-9	3MVP40B54		89644	3B5V110		115935	B73	92230 (3)	
		H								BX64	114258 (3)	
		V	10-12	3MVP50B64		115719	3B5V110		115935	BX75	92277 (3)	
		H								BX65	92276 (3)	
V	13-15	3MVP45B59	89645	3B6V90	115945	BX71	92243 (3)					
H						BX62	92411 (3)					
25 and 30	AL17, AL18	V	5-6	4MVP50B64	1-7/8	115931	4MVB154R	2-3/16	116204	BX80	92412 (4)	116206
		H								BX71	92243 (4)	
		V	7-9	4MVP45B59		115946	4MVB124R		116203	BX72	92277 (4)	
		H								BX65	92276 (4)	
		V	10-12	4MVP50B64		115931	4MVB110R		116202	B73	92230 (4)	
		H								BX63	92278 (4)	
		V	13-16	4MVP50B64		115931	4MVB94Q		116202	BX63	92278 (4)	
		H								BX61	92289 (4)	

*H = horizontal discharge. V = vertical discharge.

**Refer to [Table 26](#).

NOTE: If drive components are required for units with a 5- to 15-HP TEFC or 5- to 15-HP premium-efficiency (EE) motor, contact your Distributor or the Factory Service Department. Be prepared to provide complete model and serial No.

Table 36. Drive Components for Unit Size 3-260 with Open-Type Motor

HP	Option	Dschg*	Drive (AM) Option**	Motor Sheave			Blower Sheave			Belt		Bushing PN
				MFR's Model	Bore Size (IN)	PN	MFR's Model	Bore Size (IN)	PN	MFR's Model	PN (Quantity)	
Units with Class 1 Blower												
7-1/2, 10	AL11, AL12	H	A3	2MVP35B49	1-3/8	115940	2B5V234	1-11/16	115941	BX103	92316 (2)	115949
		V								BX113	115947 (2)	
		H	A4	2VP60		106257	2B5V234		115941	BX103	92316 (2)	
		V								BX115	115948 (2)	
		H	1-2	2MVP40B54		89641	2B5V184		115942	BX93	92313 (2)	
		V								BX105	92314 (2)	
H	3-4	2VP60	106257	2B5V160	114032	BX90	92315 (2)					
V						BX103	92316 (2)					
15, 20	AL15, AL16	H	A4	3MVP40B54	1-5/8	89644	3B5V234	115944	BX100	92318 (3)		
		V							BX113	115947 (3)		
		H	1	3MVP50B64		115719	3B5V234	115944	B101	115865 (3)		
		V							BX113	115947 (3)		
		H	2	3MVP40B54		89644	3B5V184	115943	BX90	92315 (3)		
		V							BX103	92316 (3)		
		H	3-5	3MVP40B54		89644	3B5V154	115721	B84	92273 (3)		
		V							BX97	92319 (3)		
Units with Class 2 Blower												
15, 20	AL15, AL16	H	A4	3MVP45B59	1-5/8	89645	3MVB250R	2-11/16	116446	BX103	92316 (3)	116451
		V								BX115	115948 (3)	
		H	1	3MVP40B54		89644	3MVB200R		116447	BX93	92313 (3)	
		V								BX105	92314 (3)	
		H	2-3	3MVP45B59		89645	3MVB184Q		116448	BX90	92315 (3)	
		V								BX103	92316 (3)	
H	4-6	3MVP40B54	89644	3MVB136Q	116449	BX81	92274 (3)					
V						B94	119610 (3)					
25, 30	AL17, AL18	H	1	4MVP50B69	1-7/8	116460	4MVB250R	2-11/16	116461	BX103	92316 (4)	116451
		V								BX115	115948 (4)	
		H	2-3	4MVP45B59		115946	4MVB184R		116462	BX90	92315 (4)	
		V								BX103	92316 (4)	
		H	4-5	4MVP45B59		115946	4MVB154R		116204	BX83	92333 (4)	
		V								BX96	92334 (4)	
		H	6-8	4MVP55B69		116460	4MVB154R	116204	BX85	92317 (4)		
		V							BX97	92319 (4)		

*H = horizontal discharge. V = vertical discharge.

**Refer to Table 26.

NOTE: If drive components are required for units with a 7-1/2- to 20-HP TEFC or 7-1/2- to 20-HP premium-efficiency (EE) motor, contact your Distributor or the Factory Service Department. Be prepared to provide complete model and serial No.

CABINET COMPONENTS

NOTE:

- Cabinet components for model RDF-1 series 3 units are listed in [Table 37](#) and shown in [Figure 19](#).
- Cabinet components for model RDF-2 and RDF-3 series 3 units are listed in [Table 38](#) and shown in [Figure 20](#).

Table 37. Cabinet Components (Model RDF-1, Series 3)

Item No.	Component	Description	Model	
			1-20, 1-40	1-50, 1-65
			PN (Quantity)*	
1	Top panel	Front	86879	
2		Rear	86880	
3	Clamp	Top	86882	
4	Screen	Inlet, standard units without optional inlet air hood or filter cabinet	96817	—
5	Front panel	Assembly, includes duct assembly for horizontal discharge	87685	
6		Assembly, units with bottom discharge, includes insulation	86848	
7	Access panel	Assembly, motor access, units with horizontal discharge	94360	
8	Side panel	Assembly, includes insulation	86848	
9	Door assembly	Burner/control compartment	204476	
9A	Hinge	Positioning (not shown)	158800	
10	Door assembly	Blower compartment	90321	
11	Outer post cover	Center post	86868	
12		Front corner post	86865 (2)	
13		Left rear corner post	203816	
14		Right rear corner post (not shown)	203817	
15	Post cover	Intermediate post	203815	
16	Discharge cover	For vertical discharge opening, units with horizontal discharge	203994	
17	Access cover	Assembly, pilot access (not shown)	204474	
18	Door latch (not shown)		124067	

*Quantity is one (1) unless otherwise indicated.

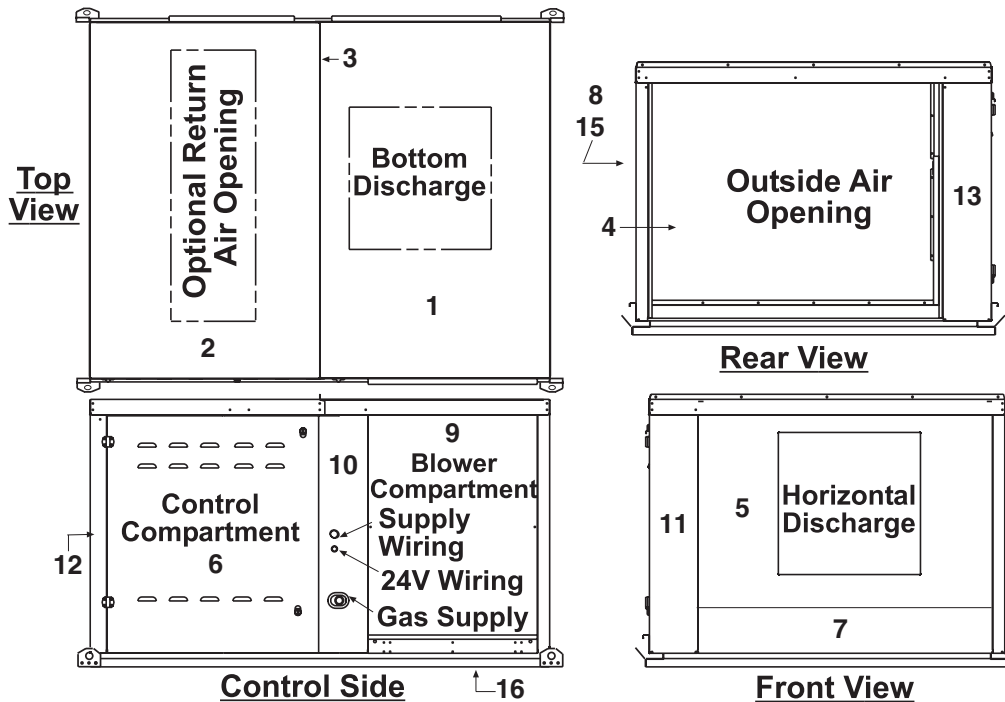

Figure 19. Cabinet Components—Model RDF-1, Series 3 (Refer to [Table 37](#))

Table 38. Cabinet Components (Models RDF-2 and RDF-3, Series 3)

Item No.	Component	Description	Model		
			2-80	2-120	3-180, 3-260
			PN (Quantity)*		
1	Top panel	Front	89558		91172
2		Center	—		91173
3		Rear	89559		91174
4	Clamp	Top	89562		91179 (2)
5	Door assembly	Right rear side	203745		204558
6		Side	89510 (2)		91116 (3)
7		Front burner/control compartment	204498		204559
8		Rear burner/control compartment	204497		204560
8A	Hinge	Positioning	158800		
9	Front panel	Assembly, includes duct assembly for horizontal discharge	89519		91125
10		Assembly, units with bottom discharge (not shown)	89967		91212
11	Outer post cover	Left front corner post	89547		91157
12		Right front corner post	89547		91158
13		Intermediate post #1	89552		204536
14		Intermediate post #2	—		91163 (2)
15		Left rear corner post	203728		203646
16		Right rear corner post	203736		203644
17	Intermediate post	Control	203729		203639
18	Discharge cover	For vertical discharge opening, units with horizontal discharge	203982	204707	204538
19	Access cover	Assembly, pilot access (not shown)	204474		203876
20	Door latch (not shown)		124067		

*Quantity is one (1) unless otherwise indicated.

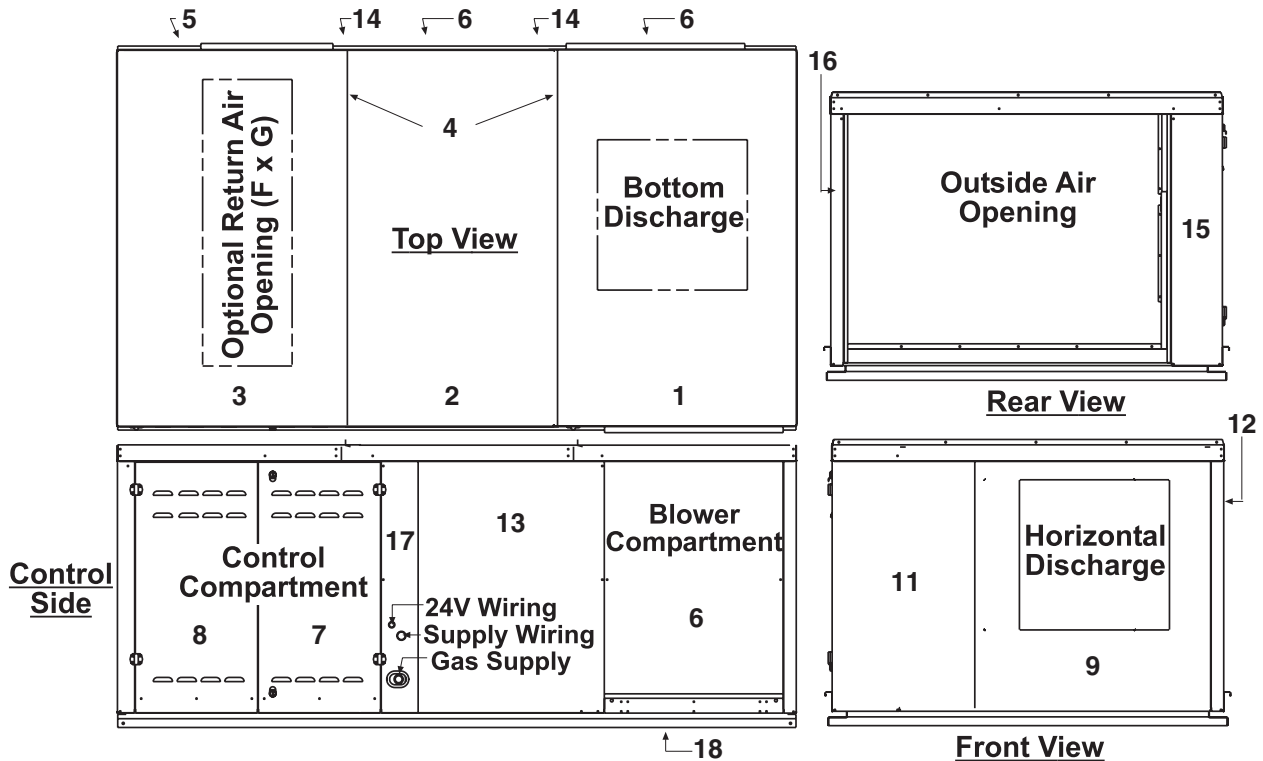

Figure 20. Cabinet Components—Models RDF-2 and RDF-3, Series 3 (Refer to Table 38)

SCREENED AIR INLET HOODS FOR OUTDOOR UNITS

NOTE:

- Screened air inlet hood option packages for outdoor units are listed in [Table 39](#).
- Option package components are listed in [Table 40](#).

Table 39. Screened Air Inlet Hood Option Packages for Outdoor Units

Option Package Description	Option	Model		
		RDF-1	RDF-2	RDF-3
		Package PN		
100% outside air inlet hood	AS2	69594	68774	71150
100% outside air inlet hood with integral filter rack and 1-inch permanent filters	AS6	69596	68739	71152
100% outside air inlet hood with integral filter rack and 2-inch permanent filters	AS7	72623	72625	72627

Table 40. Screened Air Inlet Hood Option Package Components

Model	Component	Description	Option Package PN (Option*)		
			69594 (AS2)	69596 (AS6)	72623 (AS7)
			Component PN (Quantity)**		
RDF-1	Hood panel	Top	87520	—	—
		Bottom	87530	87530	87530
		Left side	87522	87522	87522
		Right side	87523	—	—
	Weather hood	Top	—	87520	87520
	Hood corner	Right	—	87531	87531
	Louver	Left side	87525	87525	87525
		Right side	87526	87526	87526
		—	87527 (11)	87527 (11)	87527 (11)
	Screen	39 x 35-1/4 inches	87528	87528	87528
	Angle	Screen	87529 (2)	87529 (2)	87529 (2)
	Door	Filter	—	87538	87538
	Filter adapter	Side	—	87521	87521
	Filter channel	Top/bottom assembly	—	87532 (2)	94220 (2)
		Top/bottom	—	87533 (2)	—
		Top/bottom, 2-inch	—	—	94137 (2)
	Filter angle	Right side	—	87534	87534
	Filter support	Right side	—	87535	87535
	Block-off plate	Top filter	—	87536	87536
		Bottom filter	—	87537	—
	Screw	Sheet metal, #10-16 x 1/2	11813 (34)	11813 (54)	11813 (54)
	Permanent filter	12 x 35 x 1, aluminum	—	87251 (3)	—
		12 x 35 x 2, aluminum	—	—	94383 (3)

*Refer to [Table 39](#).

**Quantity is one (1) unless otherwise indicated.

Table 40. Screened Air Inlet Hood Option Package Components—Continued

Model	Component	Description	Option Package PN (Option*)		
			68774 (AS2)	68739 (AS6)	72625 (AS7)
			Component PN (Quantity)**		
RDF-2	Hood panel	Bottom	89972	89972	89972
		Top, front	90220	90220	90220
		Top, rear	90221	90221	90221
	Clamp	Top	90222	90222	90222
	Corner	Left	95279	95279	95279
		Right	89981	89981	89981
	Louver	Left side	89975	89975	89975
		Right side	89976	89976	89976
		—	89977 (14)	89977 (14)	89977 (14)
	Screen		89978	89978	89978
	Angle	Screen	89979	89979	89979
	Door	Filter	89988 (2)	89988 (2)	89988 (2)
	Filter adapter	Left	95280	95280	95280
		Right	89980	89980	89980
	Filter channel	Top/bottom assembly	—	89982 (3)	94221 (3)
		Top/bottom	—	89983 (2)	—
		Top/bottom, 2-inch	—	—	94222 (2)
	Block-off plate	Top filter	—	89986	89986
		Bottom filter	—	258249	258249
	Support		91581 (6)	91581 (6)	91581 (6)
	Nut	Hex, Keps, 1/4-20	7328 (6)	7328 (9)	7328 (6)
	Screw	Sheet metal, #10-16 × 1/2	11813 (44)	11813 (64)	11813 (64)
		Hex head, slotted, #14-10 × 3/4	41463 (3)	41463 (3)	—
Hex head, slotted, 1/4-20 × 5/8		10393 (6)	10393 (9)	10393 (6)	
Permanent filter	12 × 35 × 1, aluminum	—	87251 (4)	—	
	12 × 24 × 1, aluminum	—	89353 (4)	—	
	12 × 24 × 2, aluminum	—	—	94382 (4)	
	12 × 35 × 2, aluminum	—	—	94383 (4)	

*Refer to [Table 39](#).

**Quantity is one (1) unless otherwise indicated.

SCREENED AIR INLET HOODS FOR OUTDOOR UNITS—CONTINUED

Table 40. Screened Air Inlet Hood Option Package Components—Continued					
Model	Component	Description	Option Package PN (Option*)		
			71150 (AS2)	71152 (AS6)	72627 (AS7)
			Component PN (Quantity)**		
RDF-3	Hood panel	Top front	91575	91575	91575
		Top rear	91576	91576	91576
		Bottom	91567	91567	91567
		Left side	91568	91568	91568
		Right side	91569	91569	91569
	Clamp	Top	91577	91577	91577
	Corner	Left/right	91579 (2)	91579 (2)	91579 (2)
	Louver rack	Assembly	113003 (2)	113003 (2)	113003 (2)
	Door	Filter	91585 (2)	91585 (2)	91585 (2)
	Filter channel	Top/bottom assembly	—	91586 (5)	—
		Top/bottom assembly, 2-inch	—	—	94223 (5)
		Top/bottom	—	91580 (2)	—
		Top/bottom, 2-inch	—	—	94224 (2)
	Block-off plate	Filter	—	263784 (6)	263784 (5)
		Bottom filter	—	—	98764 (2)
		—	—	91584 (2)	—
	Filter support	Right side	272444 (2)	272444 (2)	272444 (2)
	Support		91581 (6)	91581 (6)	91581 (6)
	Post	Intermediate	91578 (2)	91578 (2)	91578 (2)
	Nut	Hex, Keps, 1/4-20	7328 (15)	7328 (15)	7328 (15)
		#C7392-110z-1	—	1849 (5)	1849 (5)
	Palnut	#Pw-1880-008-21	87900 (5)	—	—
	Screw	Sheet metal, #10-16 × 1/2	11813 (100)	11813 (100)	11813 (100)
		Hex head, slotted, #14-10 × 3/4	41463 (3)	41463 (3)	41463 (3)
		Teks, #10-16 × 1/2, S/drill	37661 (4)	37661 (4)	37661 (4)
		Hex head, slotted, 1/4-20 × 5/8	10393 (15)	10393 (15)	10393 (15)
	Permanent filter	12 × 35 × 1, aluminum	—	87251 (12)	—
		12 × 35 × 2, aluminum	—	—	94383 (10)

*Refer to [Table 39](#).

**Quantity is one (1) unless otherwise indicated.

OUTSIDE AIR FILTER RACK ASSEMBLIES FOR INDOOR UNITS

NOTE:

- Outside air filter rack assemblies for indoor units are listed in [Table 41](#).
- Option package components are listed in [Table 42](#).

Table 41. Outside Air Filter Rack Assembly Option Packages for Indoor Units

Option Package Description	Option	Model		
		RDF-1	RDF-2	RDF-3
		Package PN		
Outside air filter section for indoor units with 1-inch filters	AW3	69597	68775	71153
Outside air filter section for indoor units with 2-inch filters	AW6	72624	72626	72628

Table 42. Outside Air Filter Rack Assembly Option Package Components

Component	Description	Model					
		RDF-1		RDF-2		RDF-3	
		Option Package PN (Option*)					
		69597 (AW3)	72624 (AW6)	68775 (AW3)	72626 (AW6)	71153 (AW3)	72628 (AW6)
Component PN (Quantity)**							
Filter cabinet panel	Top	87862		89992		91590	
	Bottom	87861		89991		—	
Filter cabinet corner	Left/right rear	—		—		91587 (2)	
	Right rear	87859 (2)		89989 (2)		—	
	Right	87860 (2)		89990 (2)		—	
Duct angle	Filter cabinet	—		—		—	91583
Hood corner	Left/right	—		—		91579 (2)	
Hood panel	Bottom	—		—		91567	
Door	Filter	87538 (2)		89988 (2)		91585 (2)	91585 (2)
Filter channel	Top/bottom assembly	87532 (2)	94220 (2)	89982 (3)	94221 (3)	91586 (5)	—
	Top/bottom assembly, 2-inch	—		—		—	94223 (4)
	Top/bottom	87533 (2)	—	89983 (2)	—	91580 (2)	94224 (2)
	Top/bottom, 2-inch	—	94137 (2)	—	94222 (2)	—	
Block-off plate	Top filter	—	87536	89986		—	
	Bottom filter	—		258249		—	98764 (2)
	Filter	—		114335 (4)	114336 (4)	263784 (6)	263784 (5)
	—	—		—		91584 (2)	—
Screw	Sheet metal, #10-16 × 1/2	11813 (44)		11813 (54)		11813 (64)	11813 (50)
Permanent filter	12 × 35 × 1, aluminum	87251 (3)	—	87251 (4)	—	87251 (12)	—
	12 × 24 × 1, aluminum	—		89353 (4)	—		—
	12 × 24 × 2, aluminum	—		—	94382 (4)	—	
	12 × 35 × 2, aluminum	—	94383 (3)	—	94383 (4)	—	94383 (10)

*Refer to [Table 41](#).

**Quantity is one (1) unless otherwise indicated.

ROOF CURB COMPONENTS

NOTE:

- Each roof curb package (option CJ3) for a model RDF system includes two curb sides, one front, one back, eight curb dividers for creating supply and return air ductwork in the curb, and hardware for corner assembly and for installing ductwork dividers.
- **IMPORTANT:** The area enclosed by the roof curb must comply with clearance to combustible materials. If the roof is constructed of combustible materials, the area within the roof curb must be ventilated, left open, or covered with non-combustible material that has an R-value of at least 5. If the area within the curb is left open, higher radiated sound levels may result.
- Roof curb components are listed in [Table 43](#), dimensions are listed in [Table 44](#), and components and dimensions are shown in [Figure 21](#). The 3/4-inch (19-mm) measurement is the width of the flanges where the roof curb mates with the heater. These flange surfaces must be sealed.
- When cutting duct openings in the roof, cut the opening 1 inch (25 mm) larger than the duct size opening for installation clearance.

Table 43. Roof Curb Components

Item No.*	Component	Description	Series 3 Model		
			RDF-1	RDF-2	RDF-3
			Option CJ3 Package PN		
			204368	203980	204370
			Component PN (Quantity)		
1	Curb	Front and back assembly	104655 (2)	111508 (2)	111512 (2)
2		Side assembly	204365 (2)	204366 (2)	204369 (2)
3	Curb divider	Ductwork	203803 (4)	203977 (4)	203662 (4)
4			203804 (2)	203978 (2)	203663 (2)
5			203806 (2)	203979 (2)	203664 (2)
Roof Curb Corner Hardware					
—	Lockwasher	5/16, for top two <i>holes</i>	1333 (8)		
		5/16, for bottom two <i>holes</i>	1333 (8)		
	Lag screw	5/16 × 1, for top two <i>holes</i>	16243 (8)		
	Hex head capscrew	5/16 × 3/4, for bottom two <i>holes</i>	16247 (8)		
	Hex nut	5/16-18, for bottom two <i>holes</i>	1035 (8)		
Hardware for Divider Assembly and Attachment (to Make Duct Openings)					
—	Screw	Sheet metal, #10-16 × 1/2	11813 (64)		

*See [Figure 21](#).

Table 44. Roof Curb Dimensions

Letter Code*	Series 3 Model		
	RDF-1	RDF-2	RDF-3
	Inches (mm)		
Curb Dimensions			
A	84-5/8 (2149)	84-5/8 (2149)	131-3/4 (3346)
B	43-5/8 (1108)	67-9/16 (1716)	82-1/16 (2084)
C**	80-7/8 (2054)	80-7/8 (2054)	128 (3251)
D**	39-7/8 (1013)	63-13/16 (1621)	78-5/16 (1989)
Duct Opening Dimensions			
E	23-11/32 (593)	28-13/32 (722)	38 (965)
F	20-1/8 (511)	28-11/32 (720)	
G	5 (127)	13-15/32 (342)	11-19/32 (294)
H	10-1/4 (260)	7 (178)	4-5/8 (117)
J	25-1/2 (648)	54-11/16 (1389)	66-3/4 (1695)
K	11-1/2 (292)	17-23/32 (432)	20-1/16 (510)
M	11-15/32 (291)	8 (203)	10-15/32 (266)
N	11-1/32 (280)	11-3/32 (282)	17-1/4 (438)

*See [Figure 21](#).

**Roof opening dimensions if curb area is fully open.

NOTE: Images are not proportional for all unit sizes.

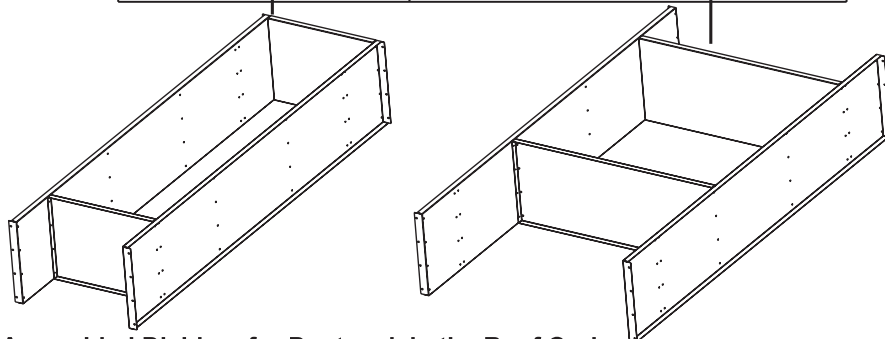
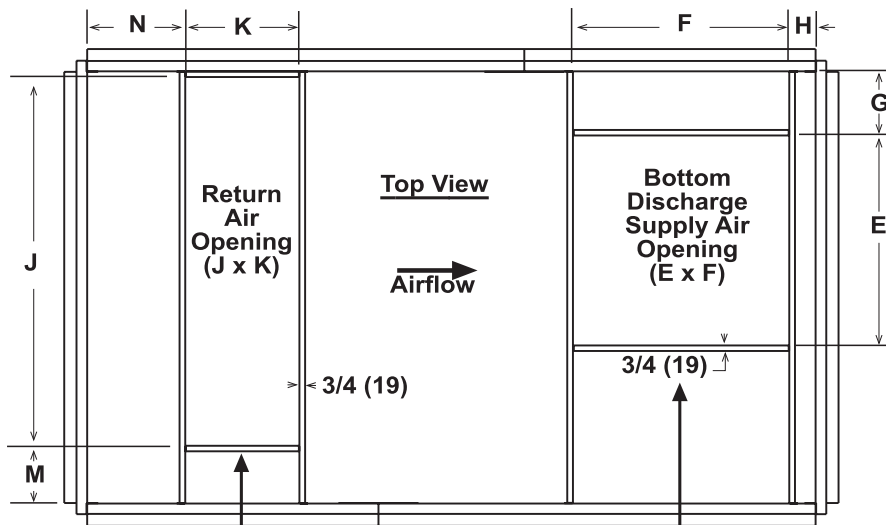
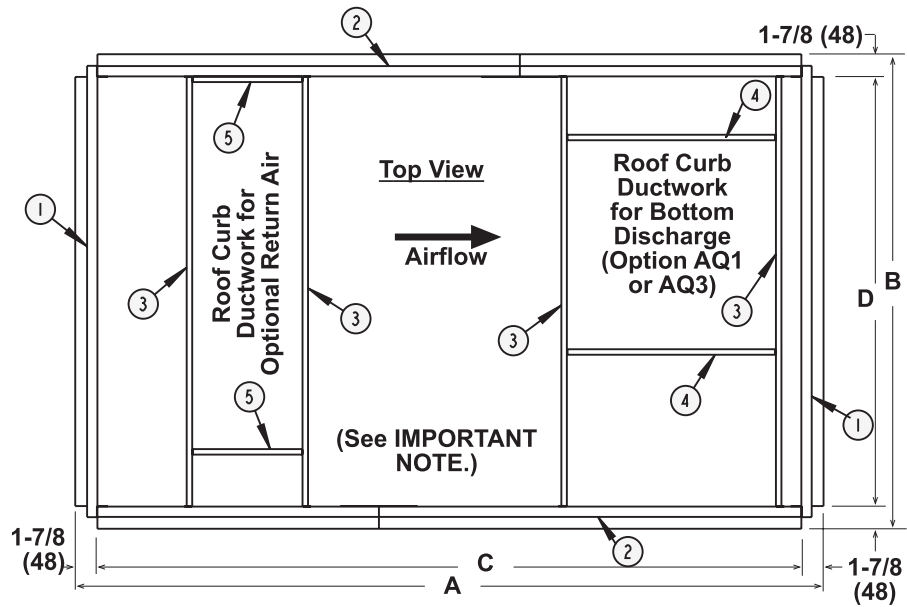

Assembled Dividers for Ductwork in the Roof Curb

Field-supplied ductwork may be either “dropped in” from the top resting on the top flange or be attached to the bottom flange, using the dividers as ductwork.

Figure 21. Roof Curb Components and Dimensions



Specifications and illustrations subject to change without notice or incurring obligations.
Latest version of this manual is available at www.reznorhvac.com.
©2022 Nortek Global HVAC LLC, O'Fallon, MO. All rights reserved.
P-RDF (02-22) 270069-A

