

Operation Manual and Parts Directory

Glas tender®

ST24, ST36, ST48, ST60, ST72 AND ST96

SLIDE TOP COOLERS



ST36-B



ST48-SF

Glastender, Inc. · 5400 North Michigan Road · Saginaw, MI · 48604-9780
800.748.0423 · 989.752.4275 · Fax 800.838.0888 / 989.752.4444 · www.glastender.com

| <u>TOPIC</u> | <u>PAGE</u> |
|---|-------------|
| Terms and Conditions | 1 |
| Warranty Statement..... | 1 |
| Installation..... | 2 |
| Operation..... | 2 |
| Cleaning Instructions | 3 |
| Electrical and Refrigeration Specifications | 3 |
| Wiring Diagrams..... | 4-5 |
| ST24 and ST36 | 4 |
| ST48, ST60, ST72 and ST96 | 5 |
| Evaporator and related parts | 6 |
| Compressor and condenser related parts | 7-8 |
| Shelving and related parts..... | 9 |
| Doors, tops and related parts | 10 |
| Refrigeration compartment covers | 11-12 |
| 220 Volt electrical parts | 12 |



TERMS AND CONDITIONS

PRICES:

All prices are LIST. Applicable taxes will be added.

QUOTATIONS:

Unless otherwise stated, quotations are effective for 30 days only.

ACCEPTANCE:

All orders are subject to acceptance by Glastender, Inc.'s headquarters in Saginaw, Michigan. Possession of the Parts Directory and Price List is not an offer to sell.

SHIPMENTS:

F.O.B. factory in Saginaw, Michigan. Partial shipments will be made unless otherwise specified by the customer. Orders are shipped via UPS or DHL unless otherwise specified.

PAYMENT TERMS:

Cash should be included with all orders unless credit terms have been arranged. To establish credit, banking and trade references are required. A convenient credit application is available upon request. Visa and Mastercard are also accepted.

DELIVERY:

Varies according to prior production commitments, but parts orders generally ship within two working days.

RETURNS:

A Return Authorization (RA) number must be issued by the factory in advance for any items that are returnable. The RA number MUST be noted on the outside of the returned package. Returns must be received within 90 days of the RA issue date. Shipping charges must be prepaid. A 20% handling charge will be applied to all authorized returns if received in new, unused condition in the original packaging.

LOSS OR DAMAGE:

Glastender, Inc. is not responsible for any loss, damage, or delay of merchandise during shipment. Such transit claims must be filed with the carrier. Merchandise must be examined on arrival. If shortages occur, Glastender, Inc. must be notified in writing within five (5) days of delivery to honor any shortage claim.

NOTE: Glastender, Inc.'s policy of constant quality improvement means that prices, specifications, and policies are subject to change without notice.

WARRANTY STATEMENT

LABOR: Glastender, Inc. warrants all products to be free of defects in material and workmanship. In established areas, a start-up and a 90-day labor warranty are included with glasswasher models GT-24 and GT-30. The GT-18 series glasswashers include a 90-day labor warranty. Self-contained refrigeration models, except beer line chillers, include a 1-year labor warranty, for the duration of one year from date of installation or up to 18 months from date of factory shipment, whichever occurs sooner. For warranty labor claims beyond 15 months from the date of factory shipment, proof of date of installation or occupancy must be provided. Authorization for labor must be obtained from Glastender within the warranty period and prior to the service being performed. Labor warranty applies to the United States and Canada only.

PARTS: Within one year from date of installation, or 15 months from date of factory shipment, whichever occurs sooner, Glastender, Inc. will replace any part or assembly found defective under normal use and service. Field replacement parts include a warranty of 90 days from date of installation. All self-contained refrigeration models include a 5-year compressor warranty.

A warranty claim form MUST accompany all returned defective parts or assemblies. This form MUST be completed in full. Failure to do so may result in delay or denial of credit. Any defective part or assembly must be returned to Glastender, Inc., Saginaw, Michigan, with all transportation and delivery charges prepaid. Warranty repairs or replacements will be shipped FOB factory in Saginaw, Michigan.

The warranty does not cover equipment subjected to accidents, freight damage, alterations, improper power and/or plumbing hookups, improper chemical use, general misuse, or lack of routine required maintenance as determined by Glastender, Inc.

No representative, distributor, dealer, or any other person is authorized to modify this warranty. This warranty replaces all other written or verbal warranties.

NOTE: Glastender, Inc.'s policy of constant quality improvement means that prices, specifications, and policies are subject to change without notice. Questions regarding this warranty should be directed to Glastender's Customer Service Representative.

03/01/07

IMPORTANT!!

Attention Refrigeration Service Companies

Please review the important warranty information on this page. If you believe a service call should be covered by the factory, please call the factory for authorization between 8AM and 5PM EST, Monday through Friday.

INTRODUCTION

This manual describes the operational features of Slide Top Coolers. Please review this information before attempting installation and operation.

Long term, trouble-free service will follow if good housekeeping and maintenance procedures are followed. Thank you for selecting Glastender, Inc. products.

UTILITY REQUIREMENTS AND CONNECTIONS

- *Electrical:* 115 Volt AC, 1 Phase, 60 Hz. A separate 15 Amp circuit is recommended. A 6-foot grounded cord is included.
- *Plumbing:* None required. Automatic condensate evaporator is included.

UNCRATING AND START-UP INSTRUCTIONS

All Slide Top Cooler models are shipped in one carton. These steps should be followed:

1. If legs or casters are included, bolt them to the base with the bolts provided.
2. Unwrap power cord from base.
3. Position unit and level and/or seal as required (see page 1-2).
4. Place racks in desired location.
5. Plug into 115 volt AC outlet.
6. Load with bottles or cans and allow time to cool. For best performance, load with pre-cooled bottles or cans. It is recommended that back-up product be stored in a walk-in cooler.
7. Your Glastender equipment is now ready for use.

SEALING SLIDE TOP BASE TO FLOOR

To comply with NSF & health codes. The slide top base must be sealed to the floor using NSF listed sealant. Place bead of sealant along outer edges of the base and remove excess with disposable towel.



OPERATION

The Slide Top Cooler is designed to maintain bottles and cans at an operating temperature range of 36°F (2°C) to 40°F (5°C).

Slide Top Coolers include an automatic defrost system. The cooler will defrost every six hours for approximately 20 minutes. During the defrost, the fan inside the cooler will remain on and the refrigeration system will turn off.

CLEANING INSTRUCTIONS

Cleaning is essential to sustaining the integrity of your equipment and preventing corrosion.

ESTIMATED CLEANING TIME: 5 to 10 minutes per unit daily, 45 minutes quarterly

FREQUENCY: Daily cleaning of exterior & door gaskets. Quarterly cleaning of interior, including shelves.

PROCEDURE:

1. A non-chlorine based cleaner or mild detergent and warm water applied with a soft cloth or sponge to all contact surfaces.
2. Immediately rinse off cleaning agent(s), using clean warm water, clean soft cloth or sponge.
3. Dry with a soft clean cloth, removing standing water as soon as possible.

NOTES:

1. Never use hydrochloric acid, wire brushes, steel wool, scrapers, or chlorine based cleaners on stainless steel surfaces, since they will break down the passivity layer and allow corrosion to occur.
2. On stainless steel surfaces, you may use a soft bristle brush or Scotch-Brite® pad for more stubborn stains. Always scrub with the direction of the grain. Follow with a thorough cleaning as described above.
3. Deposits from food preparation must be properly removed. Even hard water deposits will rust stainless steel, if not removed.
4. Repeated cleaning may dry up black-vinyl-clad steel (exterior) surfaces of the cooler. Armor All® or similar product can bring back the shine. Apply the product to a cloth and then rub into the surface, rather than spraying it directly onto the black-vinyl-clad surface.
5. The cooler door gaskets are most often overlooked when cleaning. Failure to clean them regularly will lead to premature failure, since alcohol and moisture build-up breaks down the gasket material.
6. A slide top cooler does not have an interior drain, so a large sponge is required for removing excess moisture from the interior after cleaning.

ELECTRICAL AND REFRIGERATION SPECIFICATIONS

| MODEL (L-to-R LENGTH) | ELECTRICAL | REFRIGERANT | | DESIGN PRESSURE | |
|--|---------------------------|--------------------|---------------|------------------------|------------|
| | | TYPE | CHARGE | HIGH | LOW |
| 24" | 115V, 1Ph., 60 Hz., 5 Amp | R22 | 13.5oz. | 200 | 85 |
| 36" | 115V, 1Ph., 60 Hz., 5 Amp | R22 | 13.5oz. | 200 | 85 |
| 48" | 115V, 1Ph., 60 Hz., 8 Amp | R22 | 13.5oz. | 285 | 144 |
| 60" | 115V, 1Ph., 60 Hz., 8 Amp | R22 | 13.5oz. | 285 | 144 |
| 72" | 115V, 1Ph., 60 Hz., 8 Amp | R22 | 13.5oz. | 285 | 144 |
| 96" | 115V, 1Ph., 60 Hz., 8 Amp | R22 | 13.5oz. | 285 | 144 |

WIRING DIAGRAM FOR MODELS ST24 AND ST36

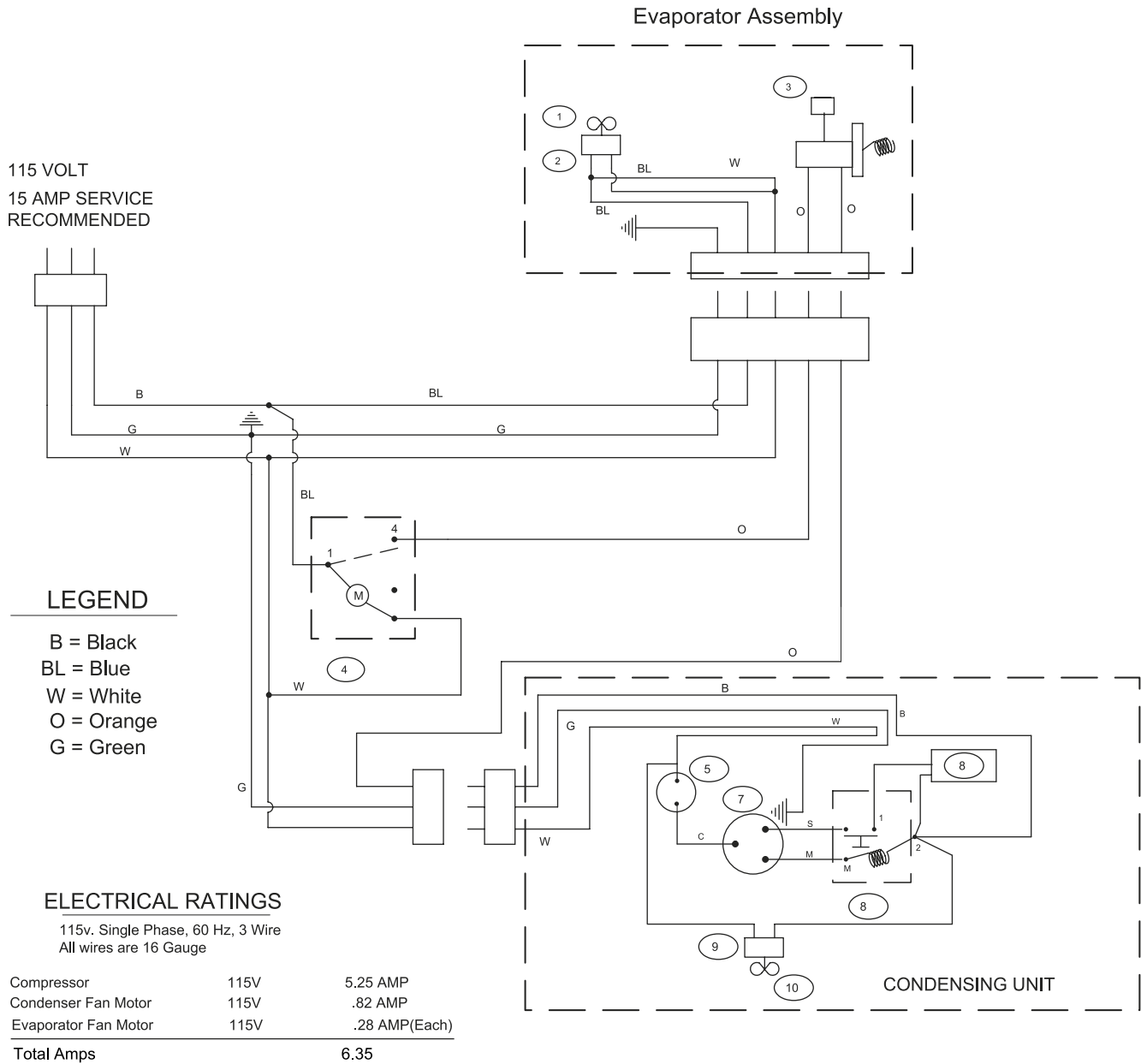

| ITEM | DESCRIPTION | PART # |
|------|-------------------------|----------|
| 1 | EVAPORATOR FAN BLADE | 06001395 |
| 2 | EVAPORATOR FAN MOTOR | 06001445 |
| 3 | THERMOSTAT | 06001405 |
| 4 | DEFROST TIMER | 06001397 |
| 5 | OVERLOAD | 06001303 |
| 6 | CAPACITOR | 06001382 |
| 7 | COMPRESSOR, 1/5 HP, R22 | 06001444 |
| 8 | START RELAY | 06001415 |
| 9 | CONDENSER FAN MOTOR | 09000336 |
| 10 | CONDENSER FAN BLADE | 07000155 |

Evaporator Assembly

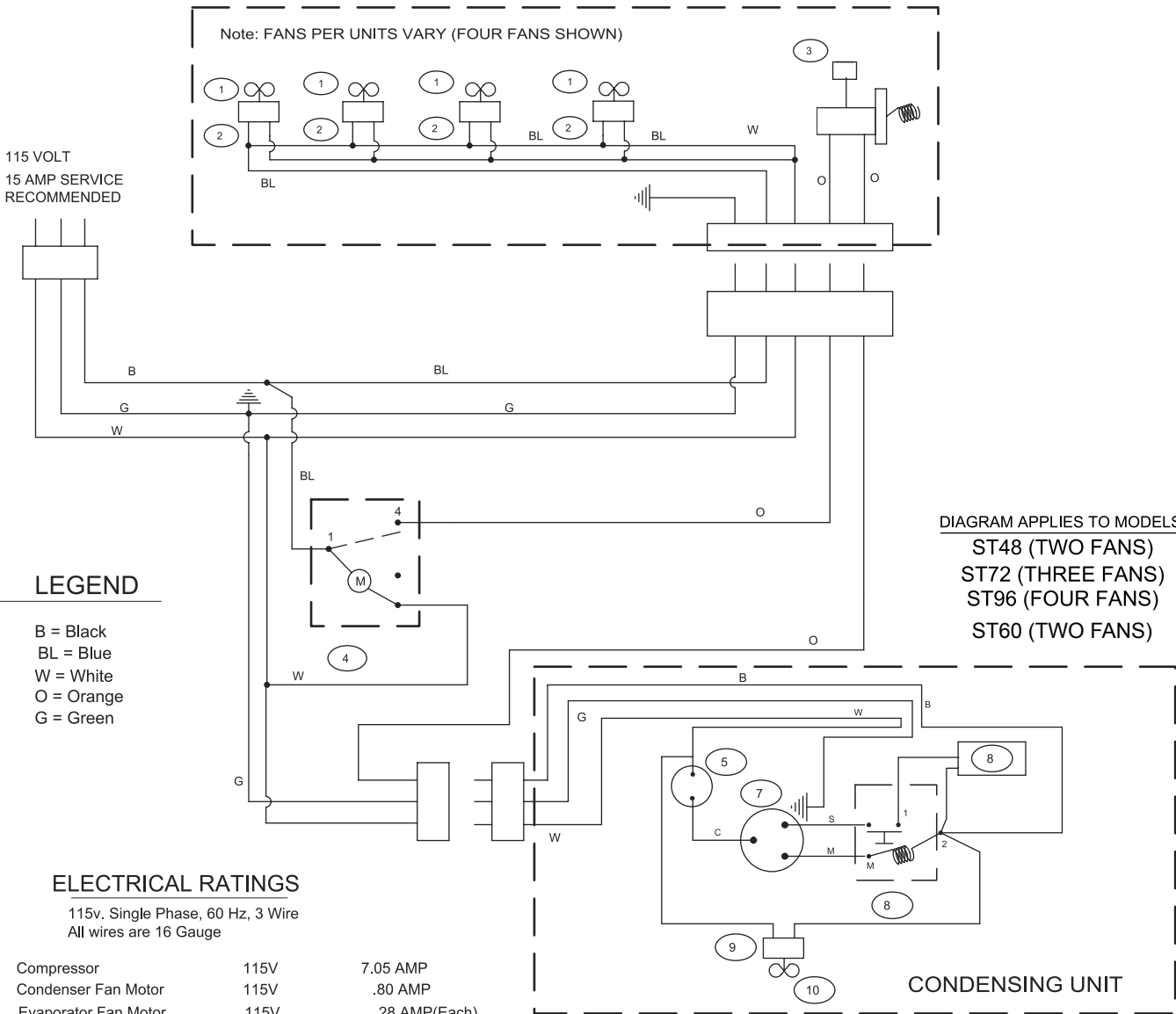

| ITEM | DESCRIPTION | PART # |
|------|-------------------------|----------|
| 1 | EVAPORATOR FAN BLADE | 06001395 |
| 2 | EVAPORATOR FAN MOTOR | 06001445 |
| 3 | THERMOSTAT | 06001405 |
| 4 | DEFROST TIMER | 06001397 |
| 5 | OVERLOAD | 07000128 |
| 6 | CAPACITOR | 06001380 |
| 7 | COMPRESSOR, 1/3 HP, R22 | 06001443 |
| 8 | START RELAY | 07000168 |
| 9 | CONDENSER FAN MOTOR | 08000085 |
| 10 | CONDENSER FAN BLADE | 08000081 |

EVAPORATOR AND RELATED PARTS



| PART NO. | OLD PART NO. | DESCRIPTION | PRICE |
|--------------|--------------|---|---------|
| 1. 07000310 | GT-031514 | Bracket, evaporator fan motor | \$14.00 |
| 2. 06001383 | GT-032301 | Guard, evaporator fan | 12.00 |
| 3. 06001395 | GT-032802 | Fan blade, evaporator, 5 blade | 5.00 |
| 4. 06001445 | GT-035107 | Fan motor, evaporator | 35.00 |
| 5. 06001405 | GT-033202 | Temperature control, includes knob | 50.00 |
| 6. 06001632 | GT-038419 | Knob, temperature control | 3.00 |
| 7. 08000079 | GT-032609 | Evaporator coil, ST24, 36 | 180.00 |
| 08000077 | GT-032604 | Evaporator coil, ST48, 60 | 285.00 |
| 08000080 | GT-032610 | Evaporator coil, ST72, 96 | 390.00 |
| 8. 08000092 | GT-036121 | Cover, front, evaporator, stainless steel, ST24, 36 | 85.00 |
| 08000093 | GT-036122 | Cover, front, evaporator, stainless steel, ST48 | 108.00 |
| 08000147 | | Cover, front, evaporator, stainless steel, ST60 | 132.00 |
| 08000094 | GT-036123 | Cover, front, evaporator, stainless steel, ST72 | 162.00 |
| 08000095 | GT-036124 | Cover, front, evaporator, stainless steel, ST96 | 210.00 |
| 08000096 | GT-036125 | Cover, front, evaporator, galvanized, ST24, 36 | 66.00 |
| 08000097 | GT-036126 | Cover, front, evaporator, galvanized, ST48 | 77.00 |
| 08000211 | | Cover, front, evaporator, galvanized, ST60 | 100.00 |
| 08000098 | GT-036127 | Cover, front, evaporator, galvanized, ST72 | 120.00 |
| 08000099 | GT-036128 | Cover, front, evaporator, galvanized, ST96 | 170.00 |
| 9. 07000229 | GT-037421 | Housing and drain pan, evaporator, ST24, 36 | 60.00 |
| 08000116 | GT-037422 | Housing and drain pan, evaporator, ST48 | 72.00 |
| 08000139 | | Housing and drain pan, evaporator, ST60 | 84.00 |
| 08000117 | GT-037423 | Housing and drain pan, evaporator, ST72 | 96.00 |
| 08000118 | GT-037424 | Housing and drain pan, evaporator, ST96 | 120.00 |
| 10. 06001345 | GT-031716 | Tubing, drain, clear plastic, 1/2" ID x 5/8" OD per ft. | 1.45 |

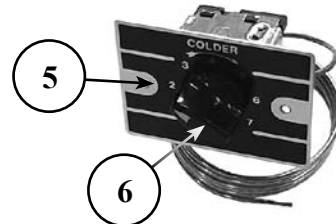
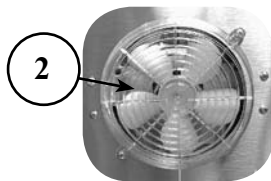
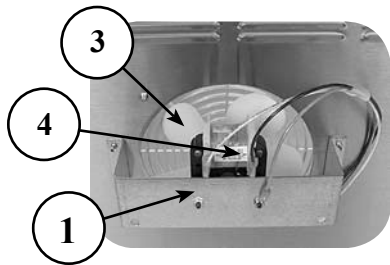

(Temperature control is located behind the front cover on the ST24,36)

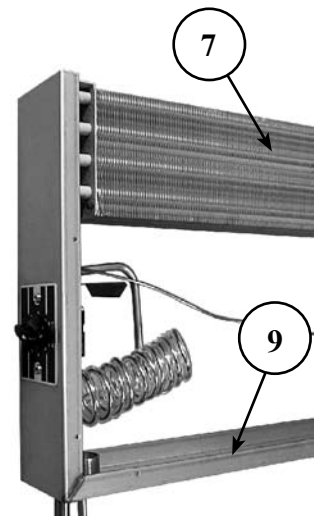
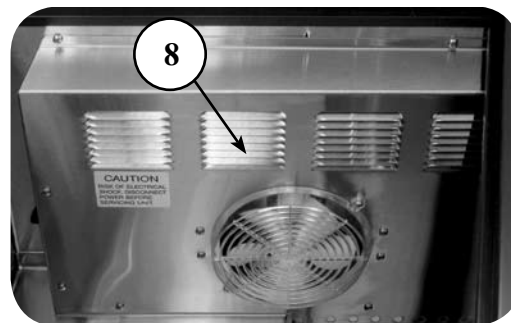
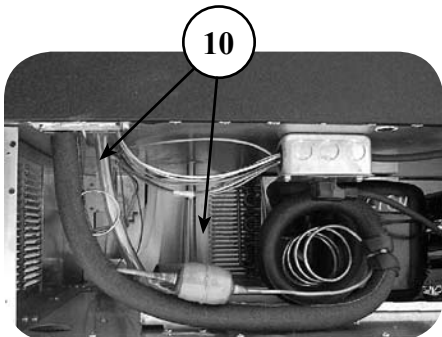

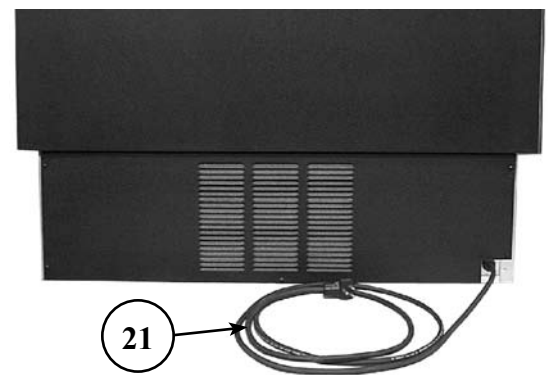
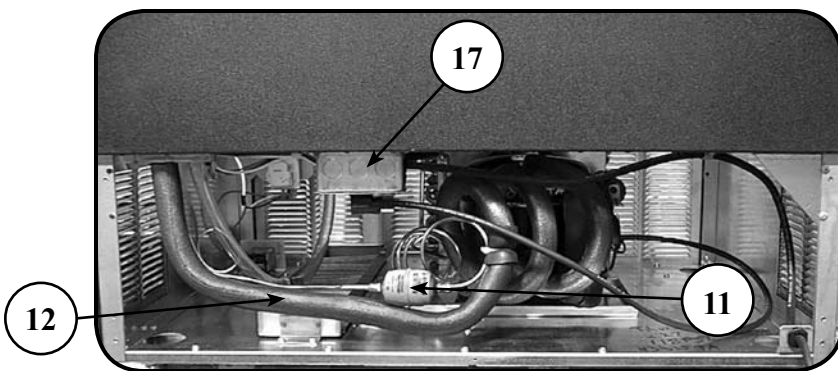
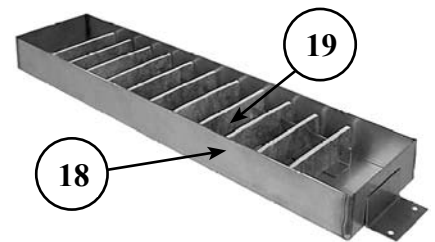
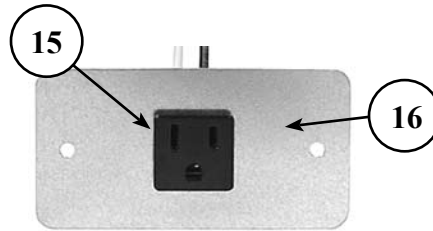
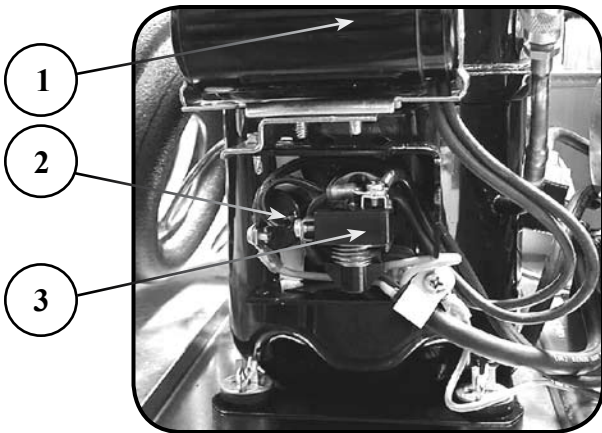
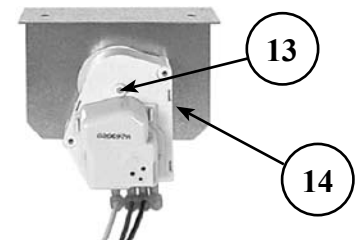
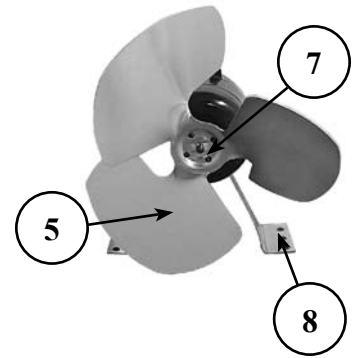
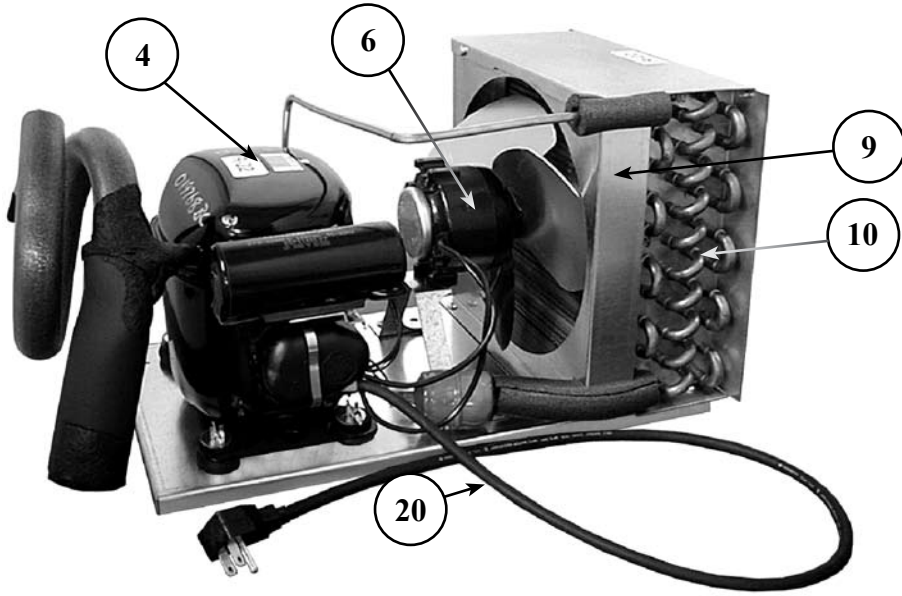

Rear view of ST36

COMPRESSOR AND CONDENSER RELATED PARTS



| <u>PART NO.</u> | <u>OLD PART NO.</u> | <u>DESCRIPTION</u> | <u>PRICE</u> |
|-----------------|---------------------|---|--------------|
| 07000172 | GT-035002 | 1/3 HP Aspera compressor, R22, ST48, 72, 96 (includes: 08000068, 06001379, and 06001414) | \$500.00 |
| 1. 06001379 | GT-032201 | Start capacitor, 1/3 and 1/5 HP Aspera compressor | 20.00 |
| 2. 08000068 | GT-031202 | Overload protector, 1/3 HP Aspera compressor, ST48, 72, 96 | 12.00 |
| 3. 06001414 | GT-034103 | Relay, 1/3 HP Aspera compressor, ST48, 72, 96 | 14.00 |
| 11000082 | GT-035005 | 1/5 HP Aspera compressor, R22, ST24, 36 (includes: 08000069, 06001379, and 08000083) | 535.00 |
| 08000069 | GT-031204 | Overload protector for 1/5 HP Aspera compressor, ST24, 36 | 15.00 |
| 08000083 | GT-034107 | Relay for 1/5 HP Aspera compressor, ST24, 36 | 15.00 |
| 4. 06001443 | GT-035025 | 1/3 HP Tecumseh compressor, R22, ST48, 60, 72, 96 (includes: 06001380, 07000168, and 07000128) | 400.00 |
| 06001380 | GT-032206 | Start capacitor for 1/3 HP Tecumseh compressor | 20.00 |
| 07000168 | GT-034112 | Relay, 1/3 HP Tecumseh compressor, ST48, 60, 72, 96 | 18.00 |
| 07000128 | GT-031207 | Overload protector for 1/3 HP Tecumseh compressor, ST48, 60, 72, 96 | 12.00 |
| 06001444 | GT-035027 | 1/5 HP Tecumseh compressor, R22, ST24, 36 (includes: 06001382, 06001415, and 06001303) | 490.00 |
| 06001382 | GT-032207 | Start capacitor for 1/5 HP Tecumseh compressor | 15.00 |
| 04000243 | GT-034113 | Relay for 1/5 HP compressor, ST24, 36 | 18.00 |
| 06001303 | GT-031208 | Overload protector for 1/5 HP compressor, ST24, 36 | 10.00 |
| 5. 08000081 | GT-032801 | Fan blade, condenser, 3 blade, ST48, 60, 72, 96 | 13.00 |
| 07000155 | GT-032803 | Fan blade, condenser, 5 blade, ST24, 36 | 10.00 |
| 6. 08000085 | GT-035106 | Motor, condenser fan, 16W, ST48, 60, 72, 96 | 110.00 |
| 09000336 | GT-035109 | Motor, condenser fan, 9W, ST24, 36 | 80.00 |
| 7. 07000179 | GT-035714 | Nut, fan blade mounting | 1.00 |
| 8. 06001319 | GT-031512 | Bracket, condenser fan motor mounting, ST48, 60, 72, 96 | 5.00 |
| 06001321 | GT-031515 | Bracket, condenser fan motor mounting, ST24, 36 | 5.00 |
| 9. 08000075 | GT-032307 | Fan shroud, condenser, ST48, 60, 72, 96 | 11.00 |
| 07000152 | GT-032302 | Fan shroud, condenser, ST24, 36 | 15.00 |
| 10. 08000076 | GT-032601 | Condenser coil, ST48, 60, 72, 96 | 220.00 |
| 08000078 | GT-032607 | Condenser coil, ST24, 36 | 145.00 |
| 11. 06004028 | | Filter dryer with service port | 25.00 |
| 08000126 | GT-031717 | Capillary tubing, 38" x .036 ID, ST24, 36 | 20.00 |
| 06001614 | GT-032510 | Capillary tubing, 110" x .054 ID, ST48, 60, 72, 96 | 20.00 |
| 06001633 | GT-032512 | Capillary tubing, 48" x .054 ID (set of two), ST96, dual evaporator | 20.00 |
| 12. 06001354 | GT-031749 | Tubing, armaflex, 1-1/8" ID x 3/8" OD (per foot) | 2.00 |
| 13. 06001397 | GT-033000 | Defrost timer, automatic | 32.00 |
| 14. 07000138 | GT-031542 | Bracket, automatic defrost timer mounting | 3.00 |
| 00000051 | GT-038773 | Screw, automatic defrost timer mounting, #6 x 1/2" PPH, SMS, zinc | 1.00 |
| 15. 06001409 | GT-033304 | Receptacle, compressor | 5.00 |
| 16. 06000011 | GT-036148 | Cover, compressor receptacle mounting | 10.00 |
| 00000030 | GT-038728 | Screw, electrical box and compressor receptacle mounting, #10 x 1/2", PPH, zinc, drll kwik (4 required) | 1.00 |
| 17. 00000168 | GT-040729 | Electrical box | 4.00 |
| 06001552 | GT-038401 | Grommet, electrical box (2 required) | 3.50 |
| 18. 08000125 | GT-038006 | Pan, condensate, ST24, 36 | 60.00 |
| 08000119 | GT-038007 | Pan, condensate, ST48, 60, 72, 96 | 115.00 |
| 19. 07000235 | GT-038203 | Wicking material, consists of 11 4" pieces, ST24, 36 (prior to 1998) | 14.00 |
| 07000234 | GT-038204 | Wicking material, consists of 11 9-1/4" pieces, ST48, 72, 96 (prior to 1998) | 24.00 |
| 08000128 | | Wicking material, consists of 20 4" pieces, ST24, 36 (after 1998) | 32.00 |
| 08000129 | | Wicking material, consists of 30 9-1/4" pieces, ST48, 60, 72, 96 (after 1998) | 50.00 |
| 20. 06001313 | GT-031400 | Power cord, condensing unit | 20.00 |
| 21. 06001314 | GT-031401 | Power cord, exterior | 35.00 |

SHELVING AND RELATED PARTS

| <u>PART NO.</u> | <u>OLD PART NO.</u> | <u>DESCRIPTION</u> | <u>PRICE</u> |
|-----------------|---------------------|--|--------------|
| 1. 08000071 | GT-031529 | Bracket, 28" divider rack, ST48 (2 required) | \$20.00 |
| 08000137 | | Bracket, 40", divider rack, ST60 (2 required) | 26.00 |
| 08000072 | GT-031530 | Bracket, 52" divider rack, ST72 (2 required) | 30.00 |
| 08000073 | GT-031531 | Bracket, 76" divider rack, ST96 (2 required) | 40.00 |
| 00000031 | GT-038729 | Screw, bracket mounting, #10 x 1/2" PPH, SS, SMS | 1.00 |
| 2. 08000082 | GT-032906 | Rack, divider, chrome, ST48, 60, 72, 96 | 50.00 |
| 3. 08000114 | GT-037206 | Divider wall, stainless steel, ST24, 36 | 60.00 |
| 08000115 | GT-037207 | Divider wall, galvanized, ST24, 36 | 41.00 |

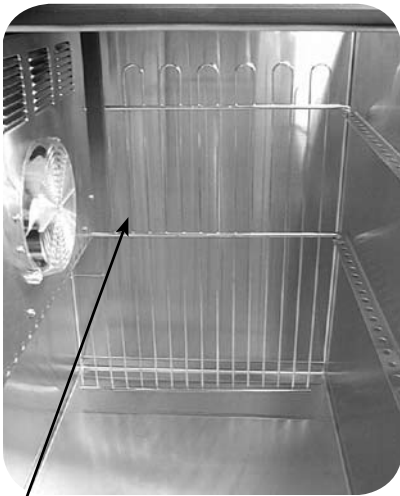

2

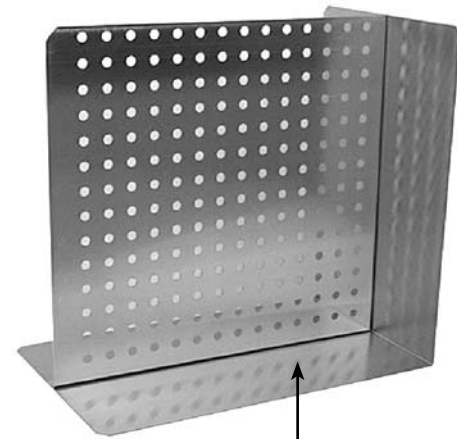

3

LIGHT KITS

| <u>PART NO.</u> | <u>DESCRIPTION</u> | <u>PRICE</u> |
|-----------------|-----------------------|--------------|
| 1. STLK-1 | Light kit, ST48, ST60 | \$140.00 |
| STLK-2 | Light kit, ST72, ST96 | 280.00 |



1

DOORS, TOPS, AND RELATED PARTS



| <u>PART NO.</u> | <u>OLD PART NO.</u> | <u>DESCRIPTION</u> | <u>PRICE</u> |
|-----------------|---------------------|---|--------------|
| 1. 07000129 | GT-031311 | Gasket, wiper, 24" top 21-1/2" long | \$10.00 |
| 07000130 | GT-031312 | Gasket, wiper, 36" top 33-1/2" long | 14.00 |
| 08000107 | GT-036221 | Sliding door, locking, 20-3/16", ST24 | 180.00 |
| 08000108 | GT-036222 | Sliding door, locking, 32-3/16", ST36 | 240.00 |
| 08000106 | GT-036217 | Sliding door, locking ST24, ST48, ST72, ST96 (pre 2000) | 180.00 |
| 08000109 | GT-036223 | Sliding door, locking, ST36 (pre 2000) | 240.00 |
| 07000213 | GT-036214 | Sliding door, 20-3/16", ST24 | 126.00 |
| 2. 07000214 | GT-036216 | Sliding door, 32-3/16", ST36 | 192.00 |
| 08000225 | | Key, CH751 for slide top cooler lock | 4.00 |
| 07000544 | | Key, AH2 for slide top cooler lock (06-07 through 08-01-07) | 4.00 |
| 3. 07000231 | GT-038113 | Top, ST24 | 126.00 |
| 07000232 | GT-038114 | Top, ST36 | 192.00 |
| 07000233 | GT-038115 | Top, ST48 | 252.00 |
| 08000184 | | Top, ST60 | 360.00 |
| 08000120 | GT-038116 | Top, ST72 | 384.00 |
| 08000121 | GT-038117 | Top, ST96 | 510.00 |
| 4. 07000250 | GT-040306 | Breaker strip, 24" sliding locking door opening, 4 pieces | 70.00 |
| 07000251 | GT-040307 | Breaker strip, 36" sliding locking door opening, 4 pieces | 80.00 |
| 07000238 | GT-038437 | Breaker strip, 24" sliding door opening, 4 pieces | 25.00 |
| 07000239 | GT-038438 | Breaker strip, 36" sliding door opening, 4 pieces | 35.00 |

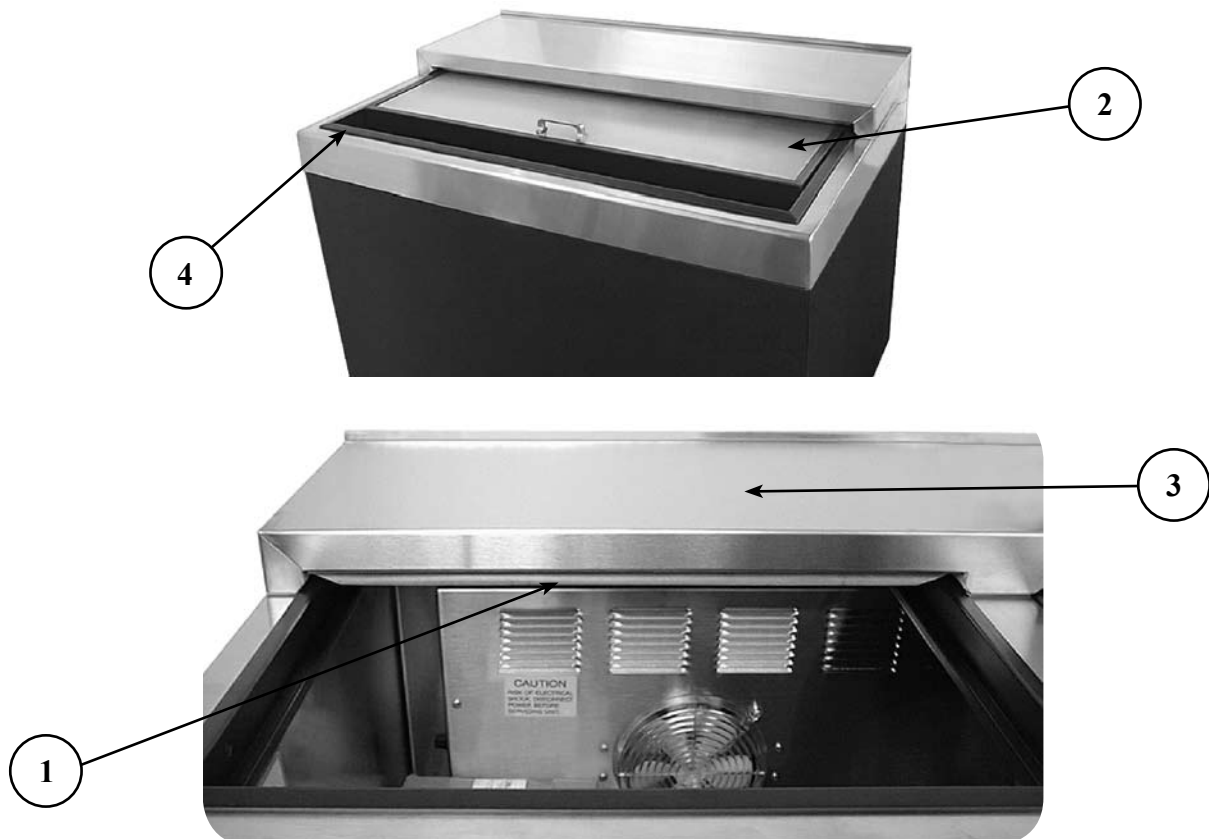

REFRIGERATION COMPARTMENT COVERS

Left Side from rear

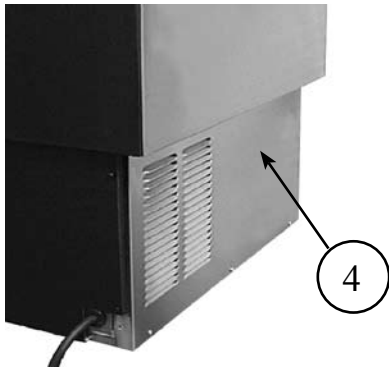

Right Side from rear

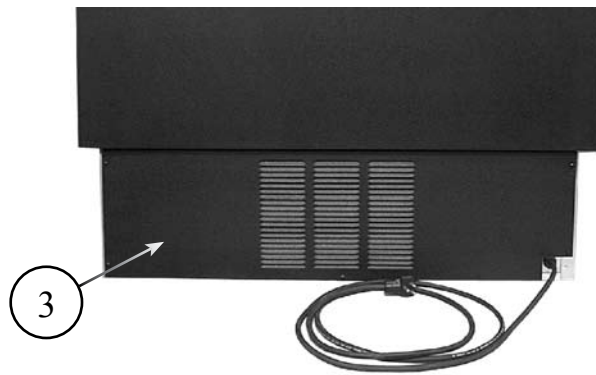
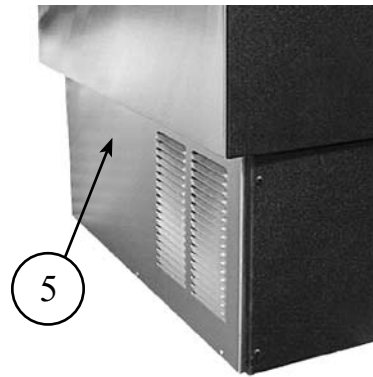

Models ST24, ST36

Rear view

Front view

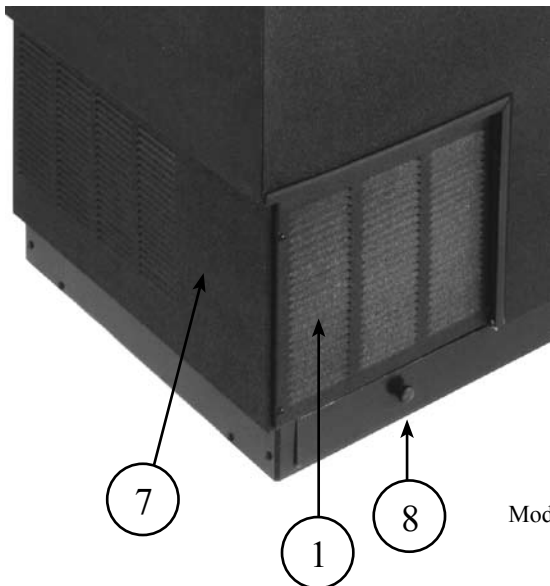

Models ST48, ST60, ST72, and ST96

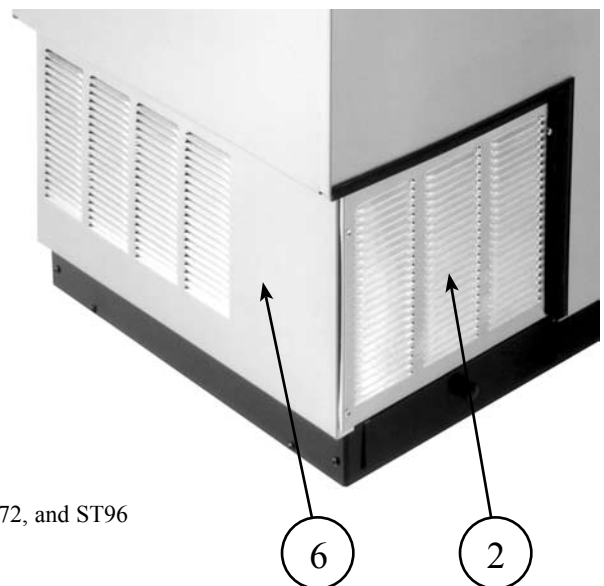

REFRIGERATION COMPARTMENT COVERS



| <u>PART No.</u> | <u>OLD PART No.</u> | <u>DESCRIPTION</u> | <u>PRICE</u> |
|-----------------|---------------------|--|--------------|
| 07000202 | GT-036129 | Cover, front, black clad vinyl, ST24 | \$40.00 |
| 07000203 | GT-036130 | Cover, front, stainless steel, ST24 | 80.00 |
| 08000100 | GT-036131 | Cover, front, black clad vinyl, ST36 | 50.00 |
| 08000101 | GT-036132 | Cover, front, stainless steel, ST36 | 100.00 |
| 1. 08000102 | GT-036133 | Cover, front or back, black clad vinyl, ST48, 60, 72, 96 | 50.00 |
| 2. 08000103 | GT-036134 | Cover, front or back, stainless steel, ST48, 60, 72, 96 | 100.00 |
| 3. 07000192 | GT-036111 | Back, black clad vinyl, ST24 | 40.00 |
| 07000193 | GT-036112 | Back, stainless steel, ST24 | 80.00 |
| 07000194 | GT-036113 | Back, black clad vinyl, ST36 | 50.00 |
| 07000195 | GT-036114 | Back, stainless steel, ST36 | 100.00 |
| 07000198 | GT-036117 | Side, left, black clad vinyl, ST24, 36 | 40.00 |
| 4. 07000199 | GT-036118 | Side, left, stainless steel, ST24, 36 | 80.00 |
| 07000200 | GT-036119 | Side, right, black clad vinyl, ST24, 36 | 40.00 |
| 5. 07000201 | GT-036120 | Side, right, stainless steel, ST24, 36 | 80.00 |
| 6. 08000105 | GT-036140 | Side, left, stainless steel, ST48, 60, 72, 96 | 80.00 |
| 7. 08000104 | GT-036139 | Side, left, black clad vinyl, ST48, 60, 72, 96 | 40.00 |
| 8. 08000119 | GT-038007 | Pan, condensate, ST48, 60, 72, 96 | 115.00 |

220 VOLT ELECTRICAL PARTS

| <u>PART No.</u> | <u>DESCRIPTION</u> | <u>PRICE</u> |
|-----------------|--|--------------|
| 06001436 | Compressor, 1/3 HP, 220/50Hz, R22, ST48, 60, 72, 96 | \$500.00 |
| 06004145 | Start capacitor, 1/3 HP R22 compressor, 220/50Hz, ST48, 60, 72, 96 | 35.00 |
| 06004146 | Relay, compressor, 1/3 HP, 220V/50Hz, R22, ST48, 60, 72, 96 | 15.00 |
| 06004147 | Overload for 1/3 HP R22 compressor, 220/50Hz, ST48, 60, 72, 96 | 15.00 |
| 11000083 | Compressor, 1/5HP, 220V, 50Hz, R22, ST24, 36 | 485.00 |
| 11000196 | Start capacitor, 1/5HP R22 compressor 220/50Hz, ST24, 36 | 15.00 |
| 11000198 | Relay, 1/5HP, R22 compressor 220V/50Hz, ST24, 36 | 19.50 |
| 11000199 | Overload protector, 1/5HP, R22, compressor 220V/50Hz, ST24, 36 | 15.00 |
| 09000337 | Motor, condenser fan, 220V, 16 watt, ST48, 60, 72, 96 | 140.00 |
| 06001451 | Motor, condenser fan, 9 watt, 220V 50/60 Hz, ST24, 36 | 120.00 |
| 06001448 | Motor, evaporator fan, 220V | 50.00 |
| 06001398 | Defrost timer, automatic, 220V, 50 cycle | 32.00 |

ELECTRICAL COMPONENTS

| <u>PART No.</u> | <u>DESCRIPTION</u> | <u>PRICE</u> |
|-----------------|--|--------------|
| 06006121 | Replacement powercord assembly, includes (06001572 06001314) | \$40.00 |

