



Quality Refrigeration

OWNER'S MANUAL

**Instructions for the installation, operation
and maintenance of all Traulsen Spacesaver Models:**

Refrigerator Models: UR30HT, UR48HT, UC27HT

Freezer Model: UR30LT

Refrigerator/Freezer Model: UR48DT

Wine Cabinets: UR30WT, UR48WT, UC27WT

This Traulsen unit is built to our highest quality standards. We build our refrigerators, freezers and heated cabinets this way as a matter of pride. This philosophy has made Traulsen the leader in commercial refrigeration since 1938. We thank you for your choice and confidence in Traulsen equipment and we know you will receive many years of utility from this equipment.

All Traulsen units are placed on a permanent record file with the service department. In the event of any future questions you may have, please refer to the model and serial number found on the name tag affixed to the unit. Should you need service, however, call us on our toll free number, 800-825-8220 between 7:30 am and 4:30 pm CST, Monday thru Friday. It is our pleasure to help and assist you in every possible way.

INSTALLER

COMPLETE THE FOLLOWING INFORMATION PRIOR TO UNIT INSTALLATION

INITIAL START DATE: _____ SERIAL NO. _____

MODEL TYPE: _____

COMPANY/INDIVIDUAL NAME: _____

INSTALLER: _____

TABLE OF CONTENTS

| | | | |
|--|--------|-------------------------------|---------|
| I. The Serial Tag | Page 1 | V. Operation | |
| II. Receipt Inspection | Page 2 | a-Adjusting The Temperature | Page 6 |
| III. Installation | | b-Automatic Defrost | Page 6 |
| a-Location | Page 2 | VI. Care & Maintenance | |
| b-Packaging | Page 2 | a-Cleaning The Condenser | Page 6 |
| c-Installing Legs or Casters | Page 2 | b-Hinge Replacement | Page 6 |
| d-Shelf Pins | Page 3 | c-Replacing The Gaskets | Page 6 |
| e-Installing The Condensate Evaporator | Page 3 | d-Cleaning The Exterior | Page 7 |
| f-Remote Installation | Page 3 | e-Cleaning The Interior | Page 7 |
| g-Cord & Plug | Page 3 | f-Changing The Interior Light | Page 7 |
| h-Power Supply | Page 3 | VII. Misc. Operations | |
| i-Wiring Diagram | Page 3 | a-Adjusting The Shelves | Page 7 |
| j-Clearance | Page 3 | b-Removing The Drawer Pans | Page 7 |
| k-Built-In Installation | Page 4 | c-Removing The Drawers | Page 7 |
| l-Electric Outlet Installation | Page 5 | VIII. Other | |
| IV. Miscellaneous Product Features | | a-Service Information | Page 7 |
| a-Solar Digital Thermometer | Page 5 | b-Spare Parts | Page 8 |
| b-Light Switches | Page 5 | c-Warranty Registration | Page 8 |
| c-Defogger Control | Page 5 | IX. Trouble Shooting Guide | Page 8 |
| | | X. Warranty Information | Page 9 |
| | | XI. Index | Page 10 |



| | | | |
|---------------------------------------|-----------------|------------------|---------------|
| SERIAL VOLTS | MODEL Hz | PH | |
| TOTAL CURRENT | AMPS | | |
| MINIMUM CIRCUIT | AMPS | | |
| MAXIMUM OVERCURRENT PROTECTION | | | AMPS |
| LIGHTS | WATTS | | |
| HEATERS | AMPS | | |
| REFRIGERANT DESIGN PRESSURE | | TYPE HIGH | OZ LOW |
| REFRIGERANT DESIGN PRESSURE | | TYPE HIGH | OZ LOW |

370-60294-00 REV (A)



I. THE SERIAL TAG

The serial tag is a permanently affixed sticker on which is recorded vital electrical and refrigeration data about your Traulsen product, as well as the model and serial number. This tag is located in the upper right interior compartment on all Spacesaver reach-in refrigerator, freezer and undercounter models.

READING THE SERIAL TAG

- Serial = The permanent ID# of your Traulsen
- Model = The model # of your Traulsen
- Volts = Voltage
- Hz = Cycle
- PH = Phase
- Total Current = Maximum amp draw
- Minimum Circuit = Minimum circuit ampacity
- Lights = Light wattage
- Heaters = Not applicable for Spacesaver models
- Refrigerant = Refrigerant type used
- Design Pressure = High & low side operating pressures and refrigerant charge
- Agency Labels = Designates agency listings

II. RECEIPT INSPECTION

All Traulsen products are factory tested for performance and are free from defects when shipped. The utmost care has been taken in crating this product to protect against damage in transit. All interior fittings have been carefully secured and the legs or casters and bottom mounted condensate evaporator are boxed and strapped inside to prevent damage. If the unit is equipped with optional locks the door keys will be attached to the handle with a nylon strip. The handle is protected by an easily removable nylon netting.

You should carefully inspect your Traulsen unit for damage during delivery. If damage is detected, you should save all the crating materials and make note on the carrier's Bill Of Lading describing this. A freight claim should be filed immediately. If damage is subsequently noted during or immediately after installation, contact the respective carrier and file a freight claim. Under no condition may a damaged unit be returned to Traulsen & Co. without first obtaining written permission (return authorization).

III. INSTALLATION

III. a - LOCATION:

Select a proper location for your Traulsen Spacesaver unit, away from extreme heat or cold. Allow enough clearance between the unit and the side wall so that the door (s) may open a minimum of 90°.

III. b - PACKAGING:

All Traulsen Spacesaver units are shipped from the factory bolted to a sturdy wooden pallet and packaged in a durable cardboard container. The carton is attached to the wooden skid with the use of large staples. These should first be removed to avoid scratching the unit when lifting off the crate.

To remove the wooden pallet, first if at all possible, we suggest that the cabinet remain bolted to the pallet during all transportation to the point of final installation. The bolts can then be removed with a 3/4" socket wrench. Avoid laying the unit on its front, side or back for removal of the pallet.

All exterior metal surfaces are protected from scratching during manufacturing and shipping by a plastic covering. This should be removed prior to installation.

NOTE: Traulsen does not recommend laying the unit down on its front, side or back. However, if you must please be certain to allow the unit to remain in an upright position afterwards for 24 hours before plugging it in so that the compressor oils and refrigerant may settle.

III. INSTALLATION (continued)

III. c - INSTALLING LEGS OR CASTERS:

6" high stainless steel legs are supplied standard for all Traulsen Spacesaver units. Casters in lieu of legs are available as an optional accessory for the same models. These are shipped from the factory packed inside a cardboard box which is strapped to one of the shelves. Remove the nylon strap and open the box, it should contain either four (4) legs or four (4) casters and sixteen (16) bolts.

WARNING: THE CABINET MUST BE BLOCKED AND STABLE BEFORE INSTALLING LEGS OR CASTERS.

To install the legs or casters, first raise and block the unit a minimum of 7" from the floor. For installing legs, thread the legs into the threaded holes on the bottom of the cabinet (see figure 1). Be certain that all legs are tightly secured (legs and casters should be tightened to 300 inch/pounds, max). When the unit is set in its final position, it is important for proper operation that the unit be level. The legs are adjustable for this purpose, turn the bottom of the leg counter-clockwise to raise it, clockwise to lower it. Level the unit from front to back as well as side to side in this manner, using a level placed in the bottom of the cabinet.

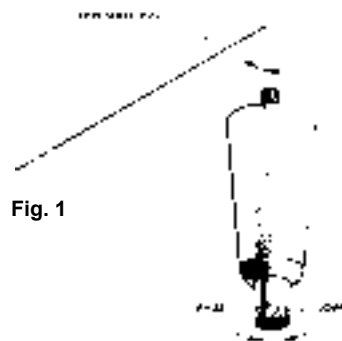

Fig. 1

Please note that Traulsen Spacesaver units are not designed to be moved while on legs. If the unit requires moving, a pallet jack or forklift should be used to prevent damage. For installing casters, the casters are "plate" type, and require the use of four (4) bolts each to secure them firmly to the cabinet bottom at each corner (see figure 2). The caster bolts are tightened using a 1/2" socket wrench.

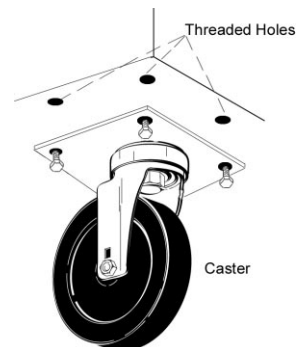

Figure 2

III. INSTALLATION (continued)

III. d - SHELF PINS:

The unit is supplied with shelves and shelf pins installed. Check all shelf pins to assure they are tightened down as they may have come loose during shipping. Rotate the pins clockwise until they are secured against the side of the cabinet.

III. e - INSTALLING THE CONDENSATE EVAPORATOR:

A bottom-mounted electric condensate evaporator is normally supplied on all self-contained models. This is shipped in a cardboard carton secured to the cabinet interior, and must be installed prior to use.

To install a bottom-mounted electric condensate evaporator (see figure 3).

After the cabinet has been uncrated and the legs/casters attached, locate the four (4) holes on the exterior bottom towards the rear of the cabinet. Then, using the four (4) screws provided, attach the mounting rails to the cabinet bottom (the end flange is to be up and be facing towards the cabinet rear). Next, place the heater into the heater bracket (note the enclosed springs are only to be used when the heater is placed on the floor). Slide heater and bracket into the mounting rails. Plug the supplied cord into both the heater on one end, and the electrical outlet, provided on the cabinet exterior bottom towards the front, on the other. Screw the "U-Trap" (UR30LT only) or 90 degree elbow joint (all other Spacesaver models) into the drain line located on the rear of the cabinet and then screw the drain extension into the U-Trap or elbow joint.

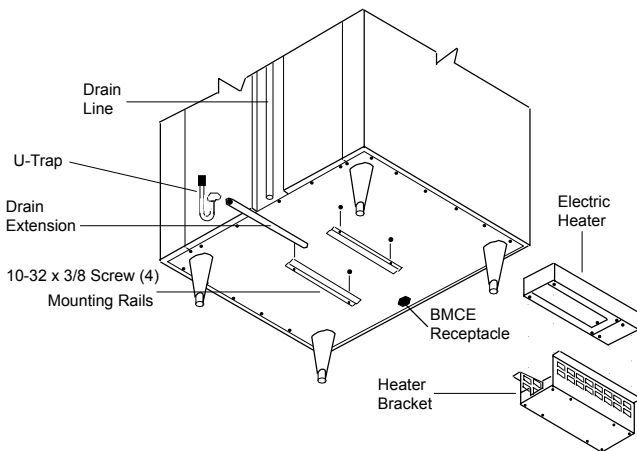

Figure 3

A remote model is normally configured for condensate to be run to a floor drain unless purchased with a condensate evaporator. The installer is responsible for making the required extension to the floor drain in accordance with good practice and local regulations.

The bottom mounted electric condensate evaporator of your Traulsen Spacesaver should be cleaned occasionally to keep it clear of dirt and debris.

III. f - REMOTE INSTALLATION:

Remote models are supplied without compressors, solenoid valves, etc. The correct voltage, amp listing, refrigerant and BTU's are listed on the unit's serial tag. It is the responsibility of the installer to specify and supply the correct size compressor(s) based upon this information and on-site requirements. Refrigerant line installation must be done in adhering to good practice and local regulations. See section "III. e" for information concerning condensate removal for remote models.

III. g - CORD & PLUG:

Most self-contained models are supplied with a cord & plug attached. It is shipped coiled at the top of the cabinet, secured by a nylon strip. For your safety and protection, all units supplied with a cord and plug include a special three-prong grounding plug on the service cord. Select only a dedicated electrical outlet with grounding plug for power source. NOTE: Do not under any circumstances, cut or remove the round grounding prong from the plug, or use an extension cord.

III. h - POWER SUPPLY:

It is recommended that the supply voltage be checked prior to connection to be certain that proper voltage for the cabinet wiring is available (refer to the serial tag to determine correct unit voltage). Make connections in accordance with local electrical codes. Use qualified electricians.

Use of a separate, dedicated circuit is recommended. Size wiring to handle indicated load and provide necessary overcurrent protector in circuit.

III. i - WIRING DIAGRAM:

Refer to the wiring diagram for any service work performed on the unit. Should you require one, please contact Traulsen Service at (800) 825-8220, and provide the model and serial number of the unit involved.

III. j - CLEARANCE:

In order to assure optimum performance, the condensing unit of your Traulsen unit MUST have an adequate supply of air for cooling purposes. Therefore, the operating location must either have a minimum of 12" clearance overhead of the condensing unit or allow for unrestricted air flow at the back of the unit. Clearance of at least 12" above is required in order to perform certain maintenance tasks.

III. INSTALLATION (continued)

III. k - BUILT-IN INSTALLATION:

Select a proper location for your unit away from extreme heat or cold. Due to the unique air flow of the unit, the Spacesaver can be built-in or used as a free-standing unit. Allow enough clearance between the unit and side wall so that the doors can be opened a minimum of 90 degrees. The floor should be level, firm and capable of supporting the weight of the fully loaded unit.

Follow the typical installation instructions outlined in Section "III. a" thru "III. j" as required.

All built-in units require a minimum of 1/2" clearance around the cabinet for servicing (see figure 5). If top clearance exceeds 1" the unit must be blocked per the free-standing instructions of Figure 6.

NOTE: If a self-contained unit is to be installed completely recessed, the front louvers must NOT be blocked or replaced with a solid panel. The front louvers allow good air circulation in the compressor compartment.

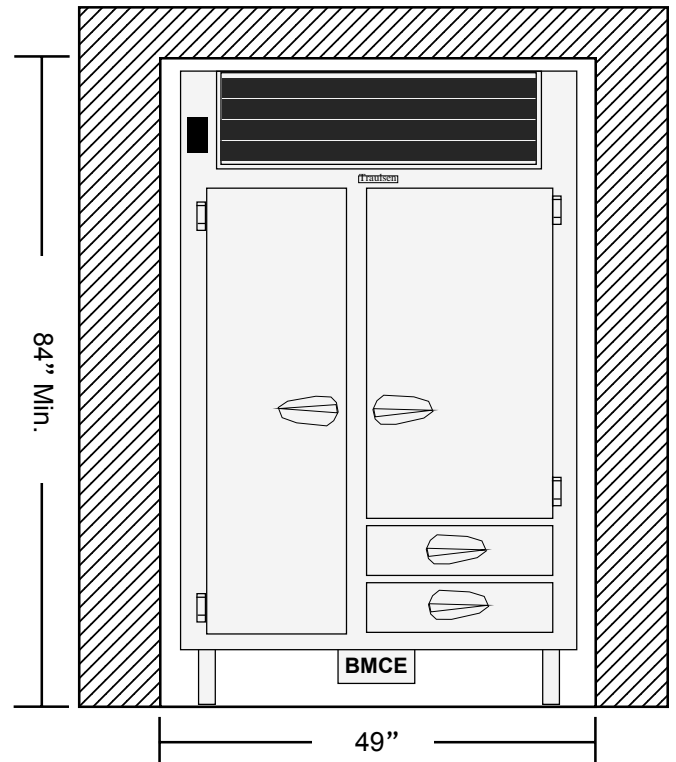

Fig. 4 - Front View
Model UR48DT
Showing Minimum Built-In Clearances

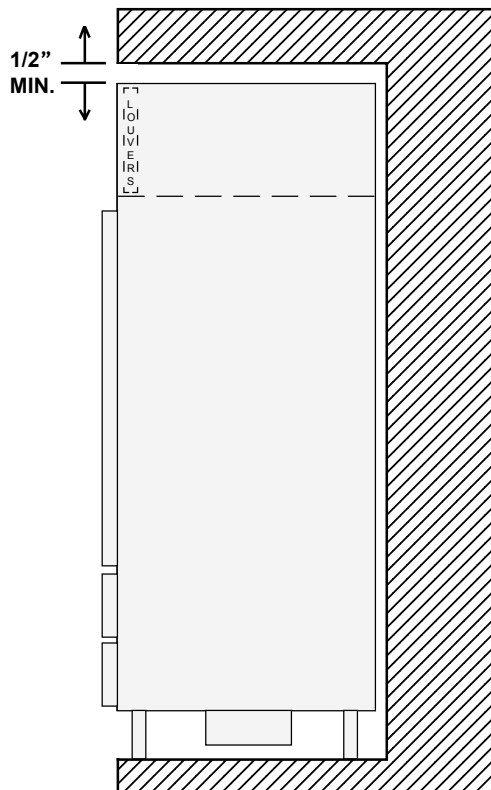

Fig. 5

Side View
Model UR48DT
Showing Built-In Installation

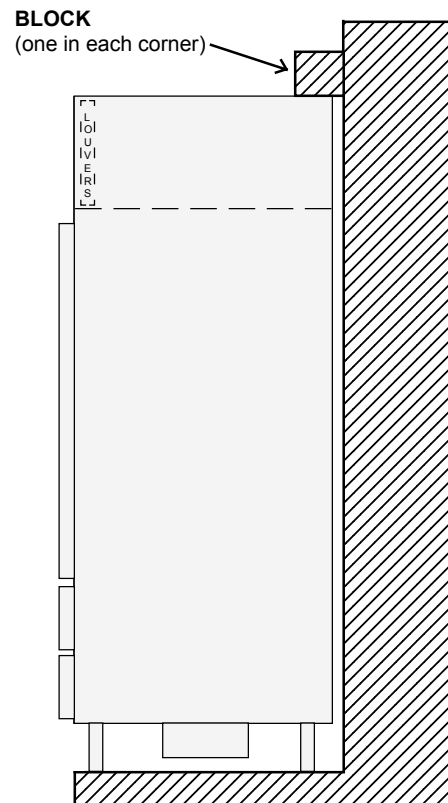

Fig. 6

Side View
Model UR48DT
Showing Free-Standing Installation

III. INSTALLATION (continued)

III. I - ELECTRICAL OUTLET INSTALLATION:

Refer to the diagram below to determine the correct location for the electrical outlet for built-in units.

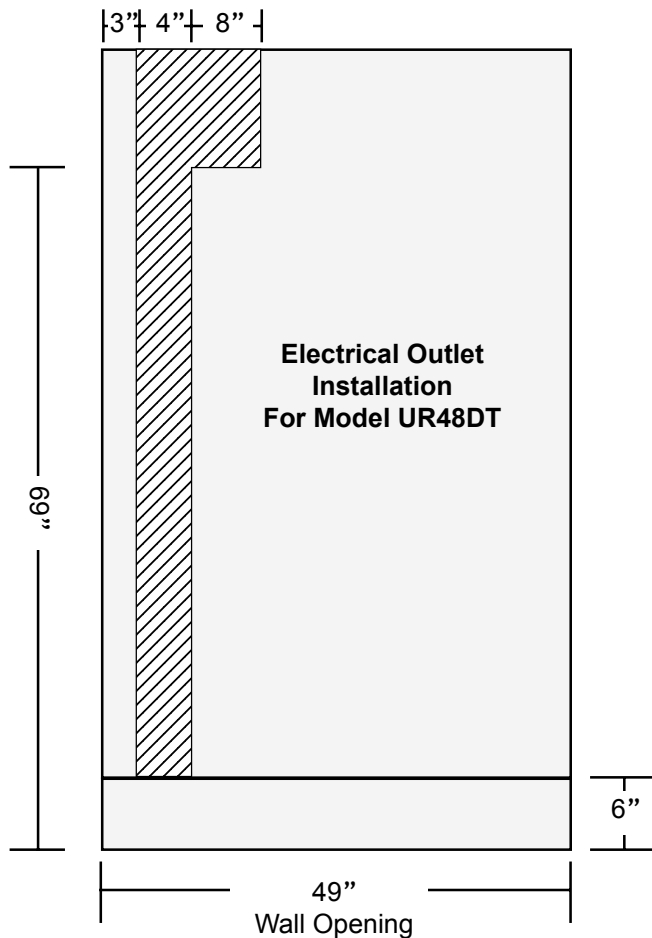

NOTE: Wall location of electrical outlet for built-in units and applications that require unit to be counter top depth, locate outlet in shaded area only.

IV. MISCELLANEOUS PRODUCT FEATURES

IV. a - SOLAR DIGITAL THERMOMETER:

All Spacesaver models are equipped with an external solar digital thermometer. It has an LED display and is mounted on the top, left side of the cabinet next to the louvers.

Thermometers on older Spacesaver models also included a battery back-up for use in low-light conditions. Prolonged use of this in low-light conditions could result in exhausting the battery. To replace the battery back-up, lift-up the louver assembly as outlined in section V. a. Next, remove the screws securing the thermometer housing cover and replace the battery.

IV. b - LIGHT SWITCHES:

All Spacesaver models include a concealed light switch mounted in the top door hinge(s), which automatically activates the interior light when the door is opened. When the door is closed, the lights are not operating. In addition, an exterior mounted, illumin-

IV. b - LIGHT SWITCHES (cont'd):

ated red switch is included for manual light control. Typically this feature is used for units supplied with glass doors. In the ON position, the lights are illuminated whether the doors are open or not. In the OFF position, the lights are controlled by the hinge switch as described in the first paragraph.

IV. c - DEFOGGER CONTROL:

As environmental conditions vary, condensation may appear on the front of your Spacesaver around the doors. To control this, Traulsen has included a manual defogger switch, which is mounted on the top, left side of the cabinet next to the louvers, below the thermometer.

When in the ON position, anti-condensate heaters around the door perimeter are activated which help to evaporate any condensation, and prevent it from recurring. This can be turned OFF when not needed in order to save energy.

V. OPERATION

V. a - ADJUSTING THE TEMPERATURE:

The refrigeration system has been properly charged and tested at the factory. Plug the unit into the power outlet to determine if the compressor(s) is running. If not, check the "ON/OFF" switches behind the louver assembly. On a refrigerator/freezer models (UR48DT) there are separate switches for each compartment (located on the right side) and both must be in the ON position.

If, after determining that your Spacesaver unit is functioning, and has had adequate time to pull-down temperature, the temperature is above/below standard ranges (34 to 38° F for refrigerators, 0 to -5° F for freezers), adjust the temperature controls. This is a black knob located behind the louver assembly along the centerline. It can be adjusted up or down one number at a time to raise or lower temperature.

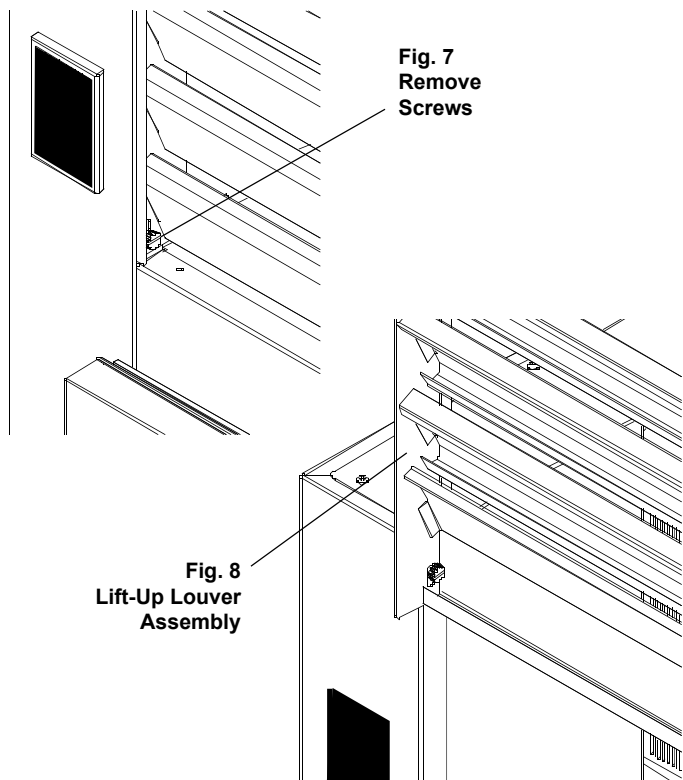

V. b - AUTOMATIC DEFROST:

The refrigerator section operates on a "cycle defrost" basis, which means, at the end of each refrigeration cycle, the coil is allowed to reach 42° F and defrost itself. This method allows for maximum efficiency of the refrigeration system.

The freezer section is normally frost free and never requires a manual defrost. When the defrost system is operating, the compressor and fans do not run.

WARNING: DISCONNECT ELECTRICAL POWER SUPPLY BEFORE CLEANING ANY PARTS OF THE UNIT.

VI. CARE & MAINTENANCE

VI. a - CLEANING THE CONDENSER:

The most important thing you can do to insure a long, reliable service life for your Traulsen is to regularly clean the condenser coil.

The condensing unit requires regularly scheduled cleaning to keep the finned condenser clean of lint and dust accumulation. The frequency of cleaning will depend on jobsite conditions, however at least once a month is strongly recommended. Keeping the condenser clean allows the cabinet to operate more efficiently and use less energy.

To clean the condenser, first disconnect electrical power to the cabinet and lift up the front louver assembly. To lift this, remove the two screws located on both sides at the bottom of the louver assembly (see figure 7). Once the screws are removed, the panel can be pivoted upwards allowing full access to the front facing condenser (see figure 8). Vacuum or brush any dirt, lint or dust from the finned condenser coil, the compressor and other cooling system parts. If significant dirt is clogging the condenser fins, use compressed air to blow this clear. Care should be taken not to bend any of the condenser fins, as this will reduce performance and compressor life.

Lower louver assembly and replace the screws to hold it in place.

VI. b - HINGE REPLACEMENT:

Both the door and hinge can be easily removed from the cabinet. To remove the door, remove the screw at the bottom of the upper hinge. Inside the upper hinge there is a small pin screw which secures the door in place. Remove this with a flat head screwdriver and the door can then be lifted off the hinge. To remove the door-half of the hinge from the door, slide hinge cover downward and then remove the three Phillips head screws which secure the hinge in place on the door.

To remove the cabinet-half of the hinge, remove the three Phillips head screws which hold it in place. On all units, the top hinge(s) contains a microswitch for controlling the interior lighting.

To reassemble the hinge reverse the previous procedure.

VI. c - REPLACING THE GASKETS:

To remove the gasket to be replaced, grasp it firmly by one corner and pull it out. Before attempting to install a new gasket, both the unit and the gasket itself must be at room temperature. Insert the four corners first by using a rubber mallet (or hammer with a block of wood). After the corners are properly inserted, work your way towards the center from both ends by

VI. CARE & MAINTENANCE (cont'd)

VI. c - **REPLACING THE GASKETS** (cont'd): gently hitting with a mallet until the gasket is completely seated in place (see figure 9 for proper gasket placement).

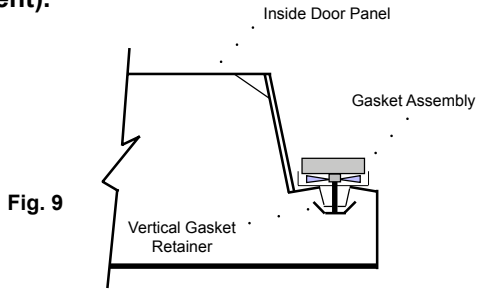

NOTE: The gasket may appear too large, but if it is installed as indicated above it will slip into place.

VI. d - **CLEANING THE EXTERIOR:**

Exterior stainless steel should be cleaned with warm water, mild soap and a soft cloth. Apply with a dampened cloth and wipe in the direction of the metal grain.

Avoid the use of strong detergents and gritty, abrasive cleaners as they may tend to mar and scratch the surface. Do NOT use cleansers containing chlorine, this may promote corrosion of the stainless steel.

Care should also be taken to avoid splashing the unit with water, containing chlorinated cleansers, when mopping the floor around the unit.

For stubborn odor spills, use baking soda and water (mixed to a 1 TBSP baking soda to 1 pint water ratio).

VI. e - **CLEANING THE INTERIOR:**

For cleaning both stainless steel and anodized aluminum interiors, the use of baking soda as described above is recommended. Use on breaker strips and as well as door gaskets. All interior fittings are removable without tools to facilitate cleaning.

VI. f - **REPLACING THE INTERIOR LIGHT BULB:**

Turn the unit OFF (the ON/OFF switch is located behind the top louver panel). Next, remove the light cover by squeezing the sides together, which releases the tabs from the holding slots. Replace the burned out light bulb with a similar type appliance bulb.

To replace the light cover, squeeze the sides together and reinsert tabs in to the holding slots and release to lock in place.

VII. MISC. OPERATIONS

VII. a - **ADJUSTING THE SHELVES:**

For shelves mounted on pins, first select the desired location and remove the white plastic covers in the interior back and sides by rotating them counter-clockwise. Next, remove the existing shelf pins by rotating them counter-clockwise. Install the pins in the desired location and tighten by rotating clockwise. Make sure the pin is securely tightened down, don't over tighten. Slide the shelf into its new position. Replace the white plastic covers into the holes vacated by the shelf pins.

VII. b - **REMOVING THE DRAWER PANS:**

For your convenience, each drawer contains two (2) removable anodized aluminum pans. They can be removed for cleaning simply by opening the drawer and lifting them out.

VII. c - **REMOVING THE DRAWERS:**

Prior to removing the drawers, food and pans should be removed. The drawer is heavy and care should be taken to keep feet clear. To remove, pull the drawer out as far as possible. Then, lift the drawer and continue to pull until the drawer is free of the unit. To replace, simply reverse the process.

VIII. OTHER

VIII. a - **SERVICE INFORMATION:**

Before calling for service, please check the following:

- Is the electrical cord plugged in?
- Is the fuse OK or circuit breaker on?
- Is the power switch "ON"?
- If there is no air movement in the freezer unit, it may be in defrost cycle. Wait 35 minutes to see if the unit will restart.
- Do the lights work?

If after checking the above items and the unit is still not operating properly, please contact an authorized Traulsen service agent. A complete list of authorized service agents was provided along with your Traulsen unit. If you cannot locate this, you may also obtain the name of a service agent from the Tech Service page of our website: www.traulsen.com.

If service is not satisfactory, please contact our in-house service department at:

Traulsen & Co., Inc.
4401 Blue Mound Road
Fort Worth, TX 76106
(800) 825-8220

Traulsen & Co., Inc. reserves the right to change specifications or discontinue models without notice.

VIII. OTHER (cont'd)

VIII. b - SPARE PARTS:

Spare or replacement parts may be obtained through a parts supplier or one of our authorized service agents. A complete list of authorized service agents accompanies this manual and is also posted on our company's official website @ www.traulsen.com.

VIII. c - WARRANTY REGISTRATION:

For your convenience, the warranties on your new Traulsen unit may be registered with us by one of two methods. Completing the enclosed warranty card (shipped with the unit), or by filling out the on-line warranty registration form located on the Technical Service page of our website (www.traulsen.com).

IX. TROUBLE SHOOTING GUIDE

| FIND YOUR PROBLEM HERE | REMEDY |
|--|---|
| 1. Condensing unit fails to start. | a. Check if line has been disconnected. b. Check switch behind louvers. |
| 2. Condensing unit operates for prolonged periods or continuously. | a. Are doors closing properly? b. Dirty condenser or filter. Clean properly. c. Evaporator coil iced. Needs to defrost. |
| 3. Food compartment is too warm. | a. Thermostat setting too high, readjust thermostat. b. Check door gasket for proper seal. c. Frequent door openings, allow adequate recovery time. d. Perhaps a large quantity of food has recently been added or the door was kept open for a long period of time, in both cases, allow adequate time for the cabinet to recover its normal operating temperature. |
| 4. Food compartment is too cold. | a. Adjust the thermostat to a warmer setting. |
| 5. Condensation on the exterior surface. | a. Condensation on the exterior surface of the unit is perfectly normal during periods of high humidity. Turn on the defogger switch. b. Check door alignment and gaskets for proper seal. |
| 6. Compressor hums but does not start. | a. Call service. |
| 7. Light bulb is not functioning. | a. Check if light bulb is burned out. b. Check to see if light switch is on (if applicable). |

X. WARRANTY INFORMATION

STANDARD DOMESTIC WARRANTY

TRAULSEN & CO., INC. warrants new equipment to the original purchaser, when installed within the United States against defective material and workmanship for one (1) year from the date of original installation. Under this warranty, TRAULSEN & CO., INC. will repair or replace, at its option, including service and labor, all parts found to be defective and subject to this warranty. The compressor part is warranted for an additional four (4) years. During this period TRAULSEN & CO., INC. will supply replacement compressor(s) if deemed defective, however, all installation, recharging and repair costs will remain the responsibility of the owner.

This warranty does not apply to damage resulting from fire, water, burglary, accident, abuse, misuse, transit, acts of God, attempted repairs, improper installation by unauthorized persons, and will not apply to food loss.

THERE ARE NO ORAL, STATUTORY OR IMPLIED WARRANTIES APPLICABLE TO TRAULSEN, INCLUDING BUT NOT LIMITED TO, ANY IMPLIED WARRANTY OF MERCHANTABILITY OR FITNESS FOR ANY PARTICULAR PURPOSE WHICH EXTEND BEYOND THE DESCRIPTION ON THE FACE HEREOF. TRAULSEN SHALL HAVE NO OBLIGATION OR LIABILITY FOR CONSEQUENTIAL OR SPECIAL DAMAGES, GROWING OUT OF OR WITH RESPECT TO THE EQUIPMENT OR ITS SALE, OPERATION OR USE, AND TRAULSEN NEITHER ASSUMES NOR AUTHORIZES ANYONE ELSE TO ASSUME FOR IT ANY OBLIGATION OR LIABILITY IN CONNECTION WITH THE EQUIPMENT OR ITS SALE, OPERATION OR USE OTHER THAN AS STATED HEREIN.

INTERNATIONAL COMMERCIAL WARRANTY

(for Canadian warranties see domestic US warranty)

TRAULSEN & CO., INC. warrants to the original purchaser the Refrigeration Equipment manufactured and sold by it to be free from defects in material and workmanship under normal use and service for a period of one (1) year from date of shipment. Under this warranty, TRAULSEN & CO., INC. will reimburse the purchaser for the replacement of any part of said equipment (excluding dryers & refrigerant gas) which then proves to be defective. This warranty is void if said equipment or any part thereof has been subject to misuse, damage in transit, accident, negligence or alteration.

TRAULSEN'S standard warranty does not apply to Export Sales. Rather, for a period of one (1) year from date of original installation not to exceed Fifteen (15) months from date of shipment from factory, TRAULSEN:

will replace, F.O.B. factory, any defective parts normally subject to warranty.

will not cover the cost of packing, freight or labor such costs being the sole responsibility of the dealer.

THIS WARRANTY IS IN LIEU OF ALL OTHER WARRANTIES EITHER EXPRESSED OR IMPLIED AND CONSTITUTES TRAULSEN'S FULL OBLIGATION AND LIABILITY. WARRANTIES NOT AVAILABLE ON REMOTE MODELS.

XI. INDEX

| | | | |
|---------------------------------|------|--------------------------|---------|
| A | | N | |
| Adjusting The Temperature | 6 | Nylon Netting | 2 |
| B | | O | |
| BTU's | 3 | Outlet - Electrical | 3, 4, 5 |
| Built-In Installation | 4 | P | |
| C | | Pallet - Shipping | 2 |
| Casters | 2 | Pans - Drawer | 7 |
| Cleaning - The Condenser | 5 | Plastic Covering | 2 |
| Cleaning - The Exterior | 6 | Power Supply | 3 |
| Cleaning - The Interior | 6 | R | |
| Clearance | 3 | Recessed Installation | 4 |
| Compressor Hold Down Provisions | 3 | Refrigerant | 2 |
| Compressor - Oil | 2 | Remote Installation | 3 |
| Condensate Evaporator | 3 | Return Authorization | 2 |
| Condensing Unit | 6, 8 | S | |
| Cord & Plug | 3 | Serial Tag | 1 |
| D | | Service Agents | 7 |
| Damage - Freight | 2 | Shelf Pins | 3, 7 |
| Defogger Control | 5 | Shelves | 3, 7 |
| Defrost - Automatic | 6 | Solenoid Valves | 3 |
| Drawer | 7 | T | |
| Drawer Pans | 7 | Temperature - Adjustment | 6 |
| E | | Thermometer | 5 |
| Electrical Outlet - Location | 5 | U | |
| F | | U-Trap | 3 |
| Fans | 6 | V | |
| Freight Claim | 2 | W | |
| G | | Warranty | 9 |
| Gaskets | 6, 7 | Warranty, Registration | 8 |
| H | | Wiring Diagram | |
| Hinge - Replacement | 6 | X | |
| I | | Y | |
| Interior Light | 7 | Z | |
| Installation - Built-In | 4 | | |
| Installation - Recessed | 4 | | |
| J | | | |
| K | | | |
| Keys - Door | 2 | | |
| L | | | |
| Legs | 2 | | |
| Lights - Interior | 7 | | |
| Light Cover | 7 | | |
| Light Switch | 5 | | |
| Louver Assembly | 6 | | |
| M | | | |

HOURS OF OPERATION:

Monday thru Friday 7:30 am - 4:30 pm CST



Quality Refrigeration

Traulsen

4401 Blue Mound Road Fort Worth, TX 76106

Phone: (800) 825-8220 Fax-Svce: (817) 740-6757

Website: www.traulsen.com