



T&S BRASS AND BRONZE WORKS, INC.
 2 Saddleback Cove / P.O. Box 1088
 Travelers Rest, SC 29690

Model No.
B-2867-04FC

Item No.

Travelers Rest, SC: 800-476-4103 • Simi Valley, CA: 800-423-0150 • Fax: 864-834-3518 • www.tsbrass.com



ADA Compliant

This Space for Architect/Engineer Approval

Job Name _____ Date _____

Model Specified _____ Quantity _____

Customer/Wholesaler _____

Contractor _____

Architect/Engineer _____

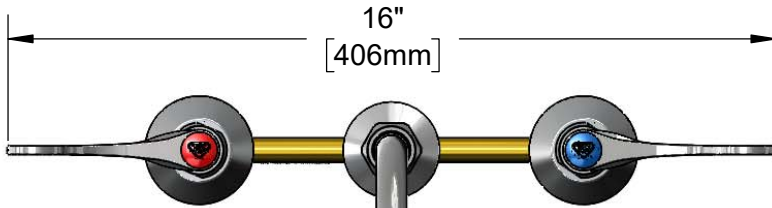

133XP-F15
 Swivel Gooseneck w/
 Plain End Outlet &
 1.5 GPM Flow Control.
 Rigid Conversion Requires
014200-45 Lock Washer
 (Included)



Swivel Joint w/
 1.5 GPM
 Flow Control

Ø 2"
 [51mm]
 Swivel Deck
 Flange

Quarter-Turn
 Eterna Cartridges w/
 Spring Checks &
 4" Wrist Action Handles
 w/ Color Coded Indexes

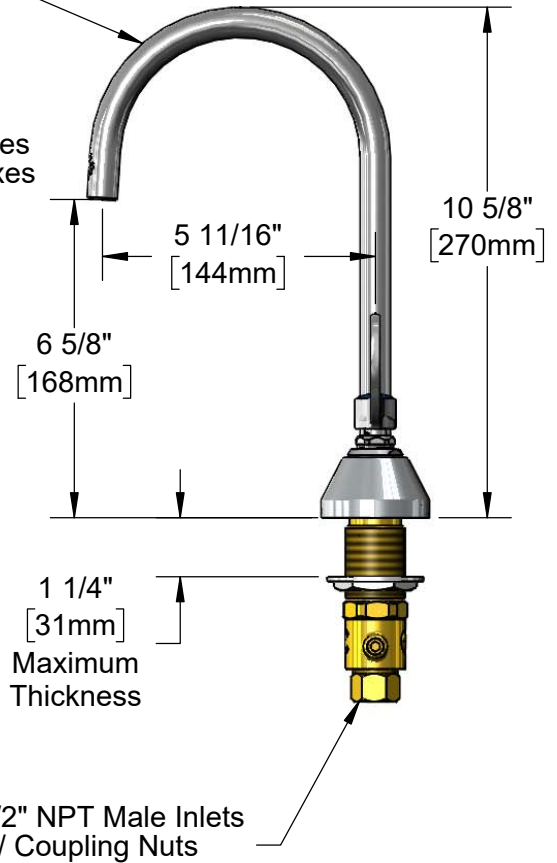
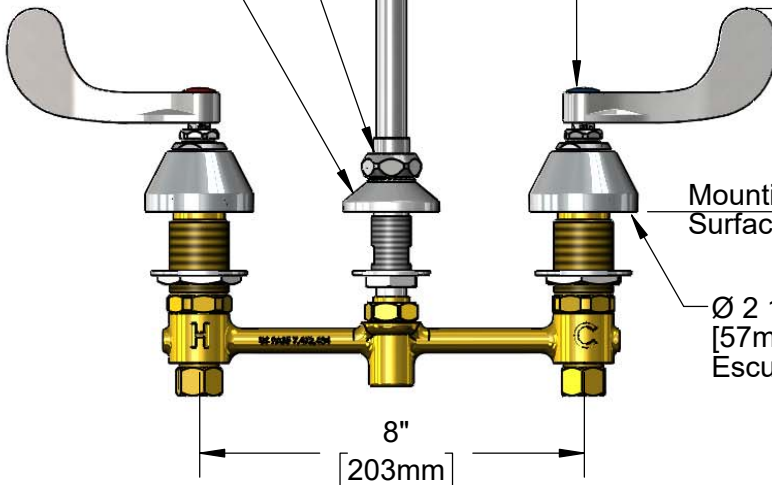

Rough-In Requirement:
 Center Shank: Ø 1" [25mm] Mounting Hole
 Hot/Cold Bodies: Ø 1 1/2" [38mm] Mounting Holes

Product Specifications:
 8" Deck Mount EasyInstall Mixing Faucet, Quarter-Turn Eterna Cartridges w/
 Spring Checks, 4" Wrist Action Handles, Swivel/Rigid Gooseneck, Plain End
 Outlet, 1.5 GPM Flow Control & 1/2" NPT Male Inlets

Product Compliance:
 ASME A112.18.1 / CSA B125.1
 NSF 61 - Section 9
 NSF 372 (Low Lead Content)
 ANSI A117.1 (ADA)



T&S BRASS AND BRONZE WORKS, INC.

2 Saddleback Cove / P.O. Box 1088
Travelers Rest, SC 29690

Model No.

B-2867-04FC

Item No.

Travelers Rest, SC: 800-476-4103 • Simi Valley, CA: 800-423-0150 • Fax: 864-834-3518 • www.tsbrass.com

ITEM NO.	SALES NO.	DESCRIPTION
1	133XP-F15	5 11/16" Plain End Swivel Gooseneck w/ 1.5 GPM Flow Disc
2	FD15	Flow Disc, 1.5 GPM [5.68 L/MIN]
3	014200-45	Star Washer, Anti-Rotation
4	016754-40NS	EasyInstall CWS Swivel Center (New Style)
5	016742-45	Center Flange Nut
6	016745-45	Compression Nut & Fitting
7	018506-19NS	Blue Button Index, Press-in
8	000925-45	Lab Handle Screw
9	B-WH4-NS	Wrist Action Handle - New Style
10	B-WH4C-NS	Wrist Action Handle, Blue Index & Screw
11	001257-40NS	Bell Escutcheon
12	016752-40NS	EasyInstall, CWS Quarter-Turn Eterna Cartridge w/ Spring Check, LTC
13	016749-45	Sidebody C-Washer
14	016777-45	CWS Hanger
15	000958-20	Coupling Nut
16	016753-40NS	EasyInstall, CWS Quarter-Turn Eterna Cartridge w/ Spring Check, RTC
17	016743-25	CWS Eterna Bonnet
18	009002-40NS	Packing Assembly (New Style)
19	B-WH4H-NS	Wrist Action Handle, Red Index & Screw
20	001193-19NS	Red Button Index, Press-in

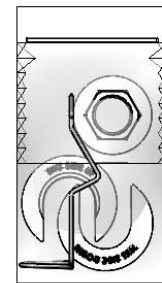
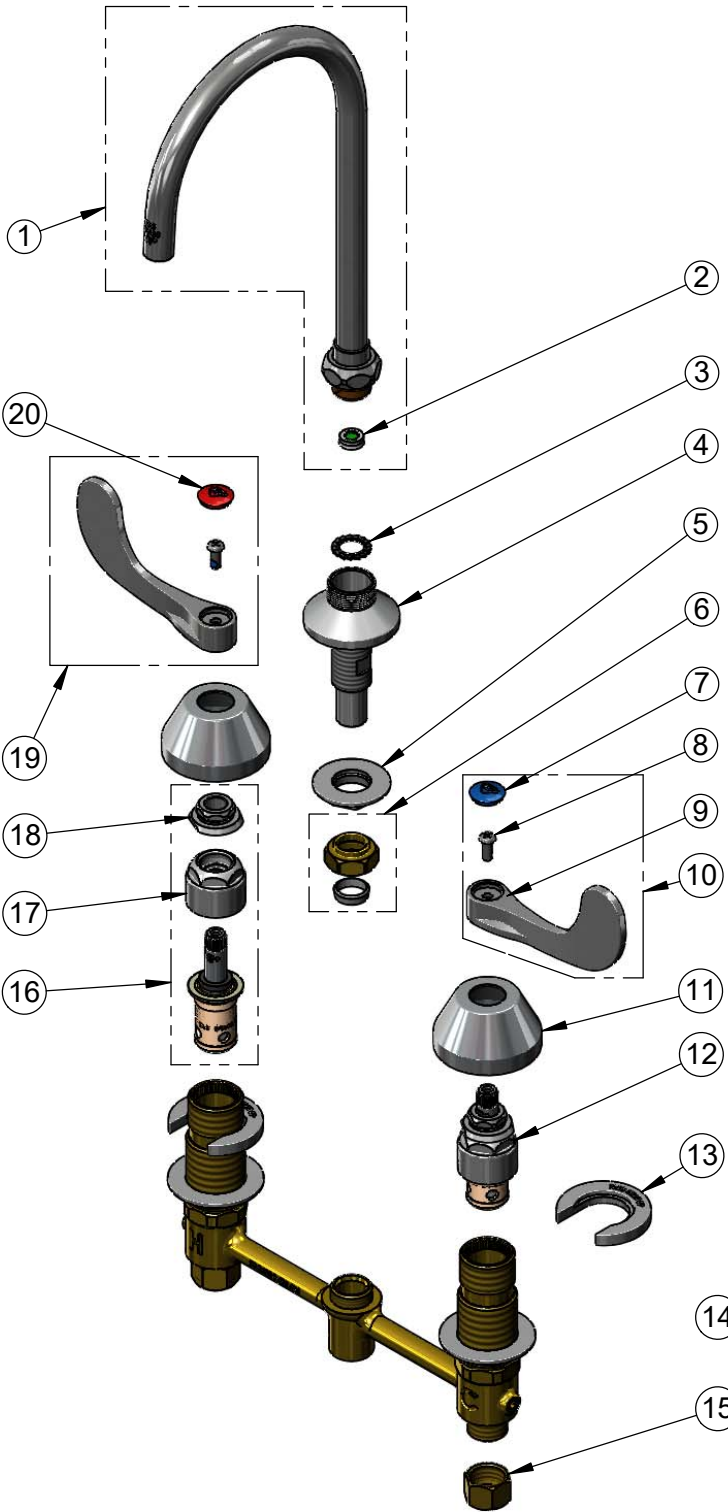

017245-40
Installation Repair Kit
Includes #5, (2)#13 & #14

Product Specifications:

8" Deck Mount EasyInstall Mixing Faucet, Quarter-Turn Eterna Cartridges w/ Spring Checks, 4" Wrist Action Handles, Swivel/Rigid Gooseneck, Plain End Outlet, 1.5 GPM Flow Control & 1/2" NPT Male Inlets

Product Compliance:

ASME A112.18.1 / CSA B125.1
NSF 61 - Section 9
NSF 372 (Low Lead Content)
ANSI A117.1 (ADA)