

TOSHIBA

FILE NO. 020-200402

SERVICE MANUAL

Color Television

N4NS Chassis

32AF44
32AFX54

TABLE OF CONTENTS

CHAPTER 1 GENERAL ADJUSTMENTS

SAFETY INSTRUCTIONS	3
SET-UP ADJUSTMENT	4
SERVICE MODE	6
DESIGN MODE	9
ELECTRICAL ADJUSTMENT	10
CIRCUIT CHECKS	12

CHAPTER 2 SPECIFIC INFORMATIONS

SETTING & ADJUSTING DATA	13
LOCATION OF CONTROLS	14
PROGRAMMING CHANNEL MEMORY	16
CHASSIS AND CABINET REPLACEMENT PARTS LIST	17
PC BOARDS BOTTOM VIEW	28
TERMINAL VIEW OF TRANSISTORS	38
CIRCUIT BLOCK DIAGRAM	40
SPECIFICATIONS	END

APPENDIX:

CIRCUIT DIAGRAM

CHAPTER 1 GENERAL ADJUSTMENTS

SAFETY INSTRUCTIONS

WARNING: BEFORE SERVICING THIS CHASSIS, READ THE “X-RAY RADIATION PRECAUTION”, “SAFETY PRECAUTION” AND “PRODUCT SAFETY NOTICE” INSTRUCTIONS BELOW.

X-RAY RADIATION PRECAUTION

1. Excessive high voltage can produce potentially hazardous X-RAY RADIATION. To avoid such hazards, the high voltage must not be above the specified limit. The nominal value of the high voltage of this receiver is (A) kV at zero beam current (minimum brightness) under a 120V AC power source. The high voltage must not, under any circumstances, exceed (B) kV.

Refer to table-1 for high voltage (A), (B).
(See SETTING & ADJUSTING DATA on page 13)

Each time a receiver requires servicing, the high voltage should be checked following the HIGH VOLTAGE CHECK procedure in this manual. It is recommended that the reading of the high voltage be recorded as a part of the service record. It is important to use an accurate and reliable high voltage meter.
2. This receiver is equipped with a Fail Safe (FS) circuit which prevents the receiver from producing an excessively high voltage even if the B+ voltage increases abnormally. Each time the receiver is serviced, the FS circuit must be checked to determine that the circuit is properly functioning, following the FS CIRCUIT CHECK procedure in this manual.
3. The only source of X-RAY RADIATION in this TV receiver is the picture tube. For continued X-RAY RADIATION protection, the replacement tube must be exactly the same type tube as specified in the parts list.
4. Some part in this receiver have special safety-related characteristics for X-RAY RADIATION protection. For continued safety, parts replacement should be undertaken only after referring to the PRODUCT SAFETY NOTICE below.

SAFETY PRECAUTION

WARNING : Service should not be attempted by anyone unfamiliar with the necessary precautions on this receiver. The following are the necessary precautions to be observed before servicing this chassis.

1. An isolation Transformer should be connected in the power line between the receiver and the AC line before any service is performed on the receiver.
2. Always discharge the picture tube anode to the CRT conductive coating before handling the picture tube. The picture tube is highly evacuated and if broken, glass fragments will be violently expelled. Use shatter proof goggles and keep picture tube away from the unprotected body while handling.
3. When replacing a chassis in the cabinet, always be certain that all the protective devices are put back in place, such as; non-metallic control knobs, insulating covers, shields, isolation resistor-capacitor network etc.
4. Before returning the set to the customer, always perform an AC leakage current check on the exposed metallic parts of the cabinet, such as antennas, terminals, screwheads, metal overlays, control shafts etc. to be sure the set is safe to operate without danger of electrical shock. Plug the AC line cord directly into a 120V AC outlet (do not use a line isolation transformer during this check). Use an AC voltmeter having 5000 ohms per volt or more sensitivity in the following manner:

Connect a 1500 ohm 10 watt resistor, paralleled by a 0.15 μ F, AC type capacitor, between a known good earth ground (water pipe, conduit, etc.) and the exposed metallic parts, one at a time. Measure the AC voltage across the combination of 1500 ohm resistor and 0.15 μ F capacitor. Reverse the AC plug at the AC outlet and repeat AC voltage measurements for each exposed metallic part. Voltage measured must not exceed 0.3 volts rms. This corresponds to 0.2 milliamp. AC. Any value exceeding this limit constitutes a potential shock hazard and must be corrected immediately.

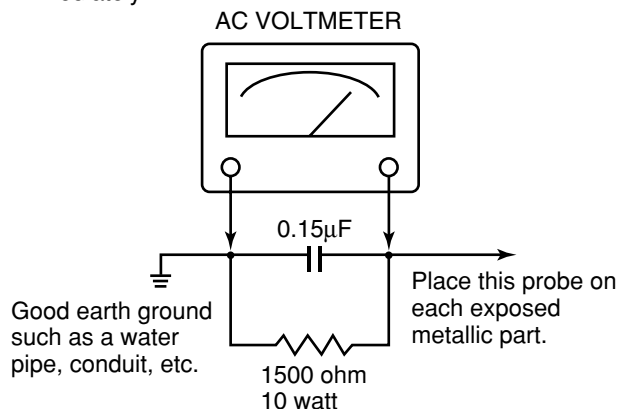

PRODUCT SAFETY NOTICE

Many electrical and mechanical parts in this chassis have special safety-related characteristics. These characteristics are often passed unnoticed by a visual inspection and the protection afforded by them cannot necessarily be obtained by using replacement components rated for higher voltage, wattage, etc. Replacement parts which have these special safety characteristics are identified in this manual and its supplements; electrical components having such features are identified by the international hazard symbols on the schematic diagram and the parts list.

Before replacing any of these components, read the parts list in this manual carefully. The use of substitute replacement parts which do not have the same safety characteristics as specified in the parts list may create shock, fire, X-ray radiation or other hazards.

WARNING: BEFORE SERVICING THIS CHASSIS, READ THE "X-RAY RADIATION PRECAUTION", "SAFETY PRECAUTION" AND "PRODUCT SAFETY NOTICE" ON PAGE 3 OF SERVICE MANUAL.

SET-UP ADJUSTMENT

■ The following adjustments should be made when a complete realignment is required or a new picture tube is installed. Perform the adjustments in order as follows :

1. Color Purity
2. Convergence
3. White Balance

Note: The PURITY/CONVERGENCE MAGNET assembly and rubber wedges need mechanical positioning. Refer to figure 1.

COLOR PURITY ADJUSTMENT

- (1) Let the screen face in the installing direction or toward the east (when it is to be moved), bring up the service mode screen after demagnetizing (front, left, right, and top) with the degaussing coil, receive white signals by pressing the [TV/VIDEO] button, and then the receiver should be operated for more than 40 minutes.
- (2) Perform rough adjustment of the central convergence with the P/C magnet according to the adjustment item.
- (3) Receive built-in green signals, loosen set screws on the deflection yoke, remove rubber wedges, and shift the deflection yoke toward front.
- (4) Move alternately the two 2-pole magnets of the P/C magnets so that the green raster can come to the center of the screen.

Figure 1.

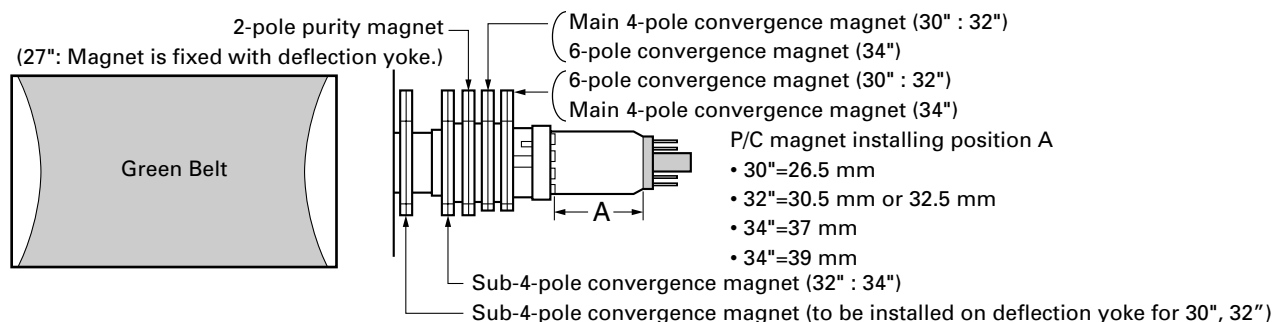

- (5) Receive built-in red and blue signals, check that there is no inclination of the single color raster toward one side, and if each color tilts to a great extent, make adjustment with the 2-pole magnet so that the 3 colors will come to the center evenly.
- (6) Receive the green raster, shift the deflection yoke from a foremost position (hitting against the picture tube) to a backward position horizontally, stop the deflection yoke at a position where it begins to become a green raster, and perform accurate marking on the picture tube.
- (7) Shift the deflection yoke further backward, and perform accurate marking at a position where the green raster begins to being luck.
- (8) Fix the deflection yoke at a position 60% forward within the range marked in items (6) and (7) above.

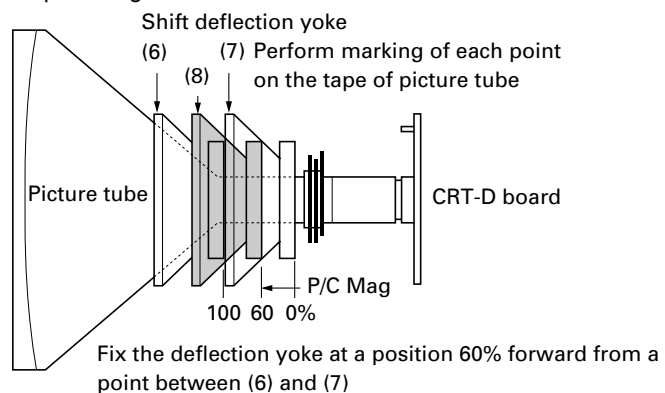

CONVERGENCE ADJUSTMENTS

* Adjust the convergence magnet to get vest convergence in the order to (1) ~ (5).

■ CENTER CONVERGENCE:

- (1) Receive the white crosshatch or dot pattern from the service signal generator.
- (2) Use the 2 pieces of main 4-pole magnets of P/C magnets, change the open angle, and align the red and blue vertical lines on the screen center.
- (3) Freeze the open angle of the main 4-pole magnets, turn them simultaneously, and align the horizontal lines.
- (4) Take the same steps for items (2) and (3) above and align red/blue with green on the screen center using two 6-pole magnets.

(5) Adjust the sub-4-pole magnets only in case there is any deviation of Xv bow-shaped convergence. (To be usually set at the initial position)
Align both sides with the sub-4-pole magnets and minimize the deviation of blue and red with the main 4-pole magnets.

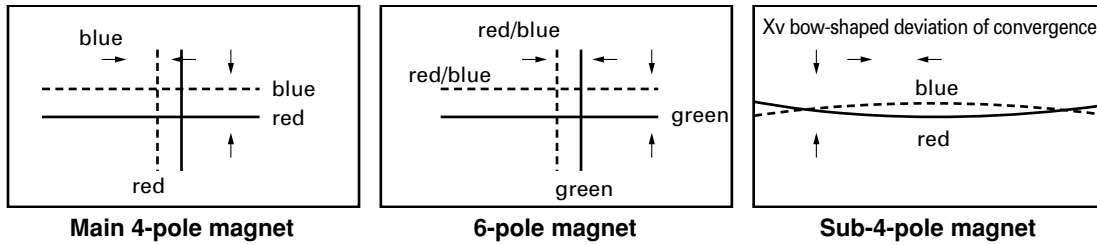

■ **CIRCUMFERENCE CONVERGENCE:**

* Perform correction in the following manner.

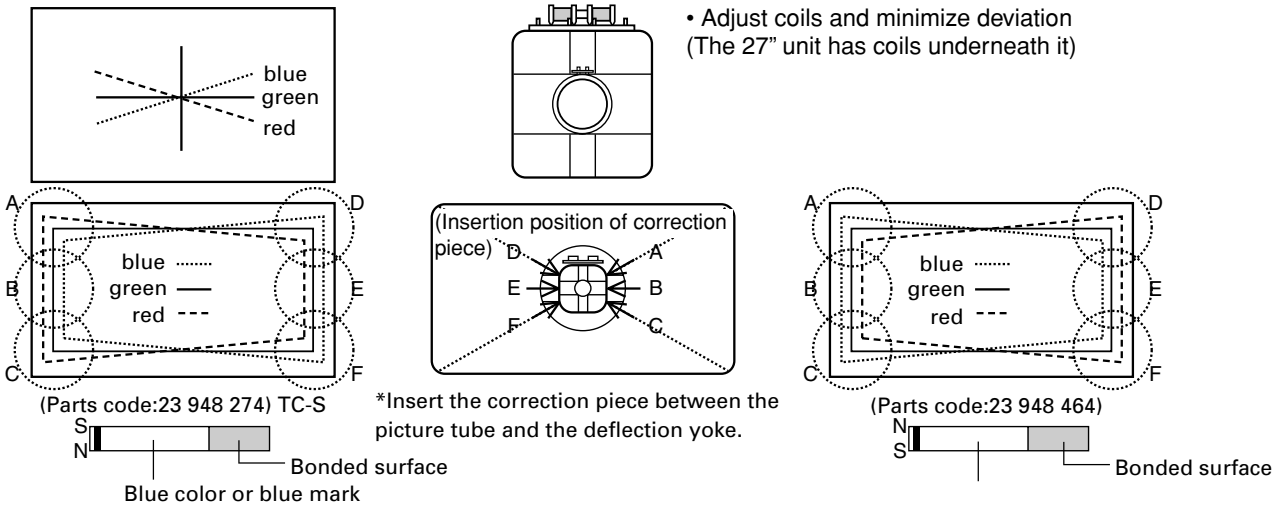

Adjust VR 1 and minimize the deviation of YH. *Only 27", 30" and 32".



Adjust VR 2 (YHC) and minimize the deviation of YH.

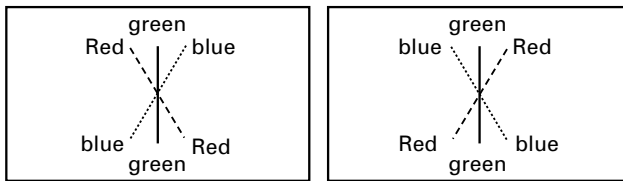

Adjust VR 3 (YV) and minimize the deviation of YV.

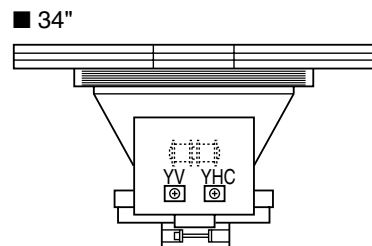
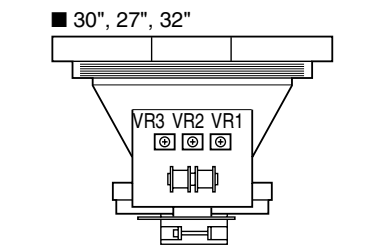
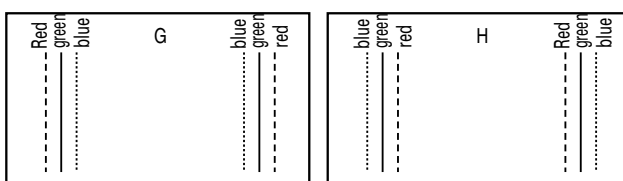
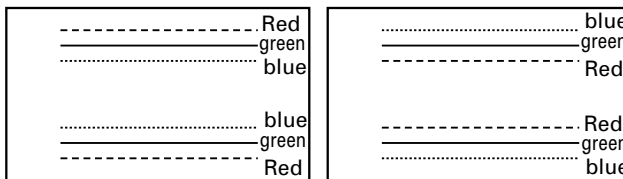

27" (Part No. 23 947 371)
32", 30" (Part No. 23 947 121)
34" (Part No. 23 993 080)

Perform correction by inserting the correction piece into the clearance of terminal board coils of the deflection yoke.
Note:
Perform insertion by turning the metal side to the terminal board side of the deflection yoke.

SERVICE MODE

1. ENTERING TO SERVICE MODE

- 1) Press MUTE button once on Remote Control.
- 2) Press MUTE button again to keep pressing.
- 3) While pressing the MUTE button, press MENU button on TV set.

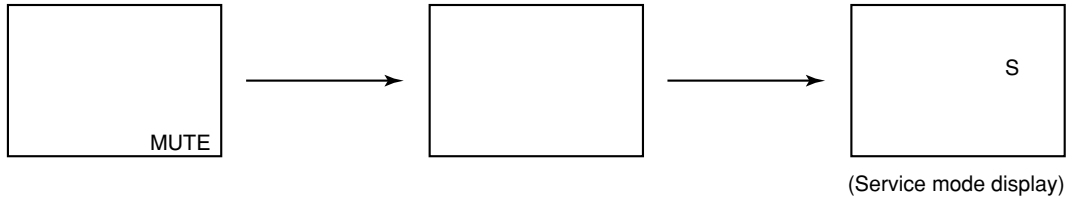

2. DISPLAYING THE ADJUSTMENT MENU

- 1) Press MENU button on TV.

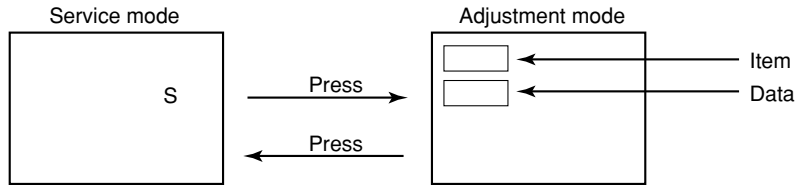

3. KEY FUNCTION IN THE SERVICE MODE

The following key entry during display of adjustment menu provides special functions.

A single horizontal line ON/OFF:	TV (ANT)/VIDEO button (on TV)
Test signal selection :	TV (ANT)/VIDEO button (on Remote)
Selection of the adjustment items :	Channel ▲/▼ (on TV or Remote)
Change of the data value :	Volume ▲/▼ (on TV or Remote)
Adjustment menu mode ON/OFF :	MENU button (on TV)
Initialization of the memory (QA02) :	RECALL+Channel button on TV (▲)
Initialization of the self diagnostic data:	RECALL+Channel button on TV (▼)

“RCUT” selection :	1 button
“GCUT” selection :	2 button
“BCUT” selection :	3 button
“SCNT” selection :	4 button
“COLC” selection :	5 button
“TNTC” selection :	6 button
Self diagnostic display ON/OFF :	9 button

4. SELECTING THE ADJUSTING ITEMS

- 1) Every pressing of CHANNEL ▲ button in the service mode changes the adjustment items in the order of table-2. (▼ button for reverse order)

Refer to table-2 for preset data of adjustment mode.
(See SETTING & ADJUSTING DATA on page 13)

5. ADJUSTING THE DATA

- 1) Pressing of VOLUME ▲ or ▼ button will change the value of data in the range from 00H to FFH. The variable range depends on the adjusting item.

6. EXIT FROM SERVICE MODE

- 1) Pressing POWER button to turn off the TV once.

■ INITIALIZATION OF MEMORY DATA OF QA02

After replacing QA02, the following initialization is required.

1. Enter the service mode, then select any register item.
2. Press and hold the RECALL button on the Remote, then press the CHANNEL ▲ button on the TV. The initialization of QA02 has been completed.
3. Check the picture carefully. If necessary, adjust any adjustment item above.
Perform "Programming Channel Memory" on the owner's manual.

CAUTION: Never attempt to initialize the data unless QA02 has been replaced.

7. TEST SIGNAL SELECTION

- 1) Every pressing of TV/VIDEO button on the Remote Control in the Service mode, changes the built-in test patterns on screen in the following order.

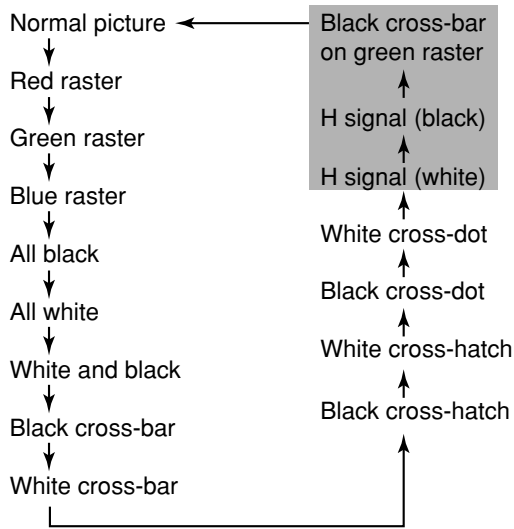

Note: If the video cable is connected to the VIDEO1 INPUT jack, the built-in pattern signals are not displayed.

Signals	Picture
<ul style="list-style-type: none"> • Red raster • Green raster • Blue raster • All Black • All White 	
<ul style="list-style-type: none"> • Black & White 	
<ul style="list-style-type: none"> • Black cross-bar • White cross-bar • Black cross-bar on green raster 	
<ul style="list-style-type: none"> • Black cross-hatch • White cross-hatch 	
<ul style="list-style-type: none"> • Black cross-dot • White cross-dot 	
<ul style="list-style-type: none"> • H signal (white) • H signal (black) 	

* The signals marked with ■ are not usable to display in the Test signal for some model.

DESIGN MODE

1. ENTERING TO DESIGN MODE

- 1) Select the Service mode.
- 2) While pressing RECALL button on Remote and press MENU button on TV.
- 3) Press MENU button on TV.

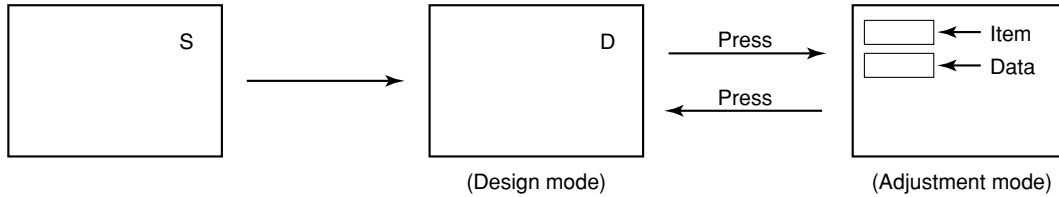

When QA02 is initialized, items "OPT0" and "OPT1" and "OPT2" of DESIGN MODE are set to the data of the representative model of this chassis family.

Therefore, because ON-SCREEN specification remains in the state of the representative of model. This model is required to reset the data of items "OPT0" and "OPT1" and "OPT2".

2. SELECTING THE ADJUSTING ITEMS

Every pressing of CHANNEL ▼ button in the design mode changes the adjustment items in the order of table-3. (▲ button for reverse order)

Refer to table-3 for data of design mode.
(See SETTING & ADJUSTING DATA on page 13)

3. ADJUSTING THE DATA

Pressing of VOLUME ▲ or ▼ button will change the value of data.

ELECTRICAL ADJUSTMENT

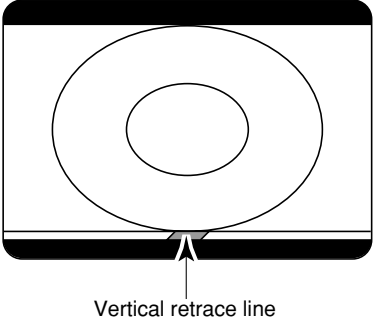
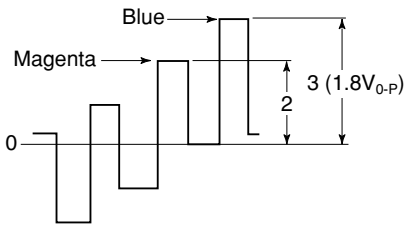
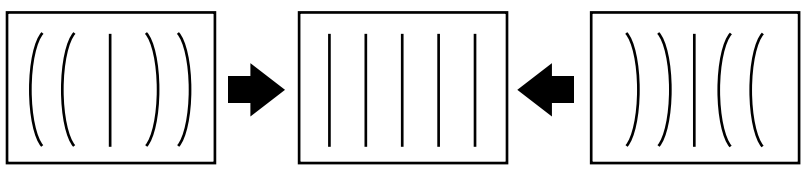
ITEM	ADJUSTMENT PROCEDURE
FOCUS VR ADJ	<ol style="list-style-type: none"> 1. Enter the service mode, then select any register item. 2. Press the TV/VIDEO button on the Remote until the black cross-bar pattern appears on the screen. 3. Adjust the FOCUS control (on T461) for well defined scanning lines on the picture screen.
SUB-BRIGHTNESS (BRTC)	<ol style="list-style-type: none"> 1. Constrict the picture height until the vertical retrace line appears adjusting the HEIGHT control on the MAIN board. 2. Adjust the CONTRAST to the minimum and BRIGHTNESS to the center. 3. Enter the service mode, then select "BRTC" register. 4. Adjust the data value so the belt of vertical retrace line just disappear. 5. Adjust the CONTRAST for the desired contrast. 6. Adjust the HEIGHT control. <div style="text-align: center;">  </div>
SUB-COLOR (COLC) SUB-TINT (TNTC)	<ol style="list-style-type: none"> 1. Receive color-bar signal from color-bar generator. 2. Press the RESET button. 3. Connect oscilloscope to base of Q906 on CRT-D board. 4. Enter the service mode, then select "COLC". 5. Adjust the SUB-COLOR by pressing the VOLUME ▲ or ▼ button to achieve about 1V_{0-p} of blue bar. 6. Select "TNTC" register. 7. Adjust the data value to obtain the blue bar to magenta bar ratio of 3:2 as shown. 8. Select "COLC" register. 9. Adjust the data value to achieve 1.8V_{0-p} of blue bar on scope. 10. Check the picture with off-air signal. <div style="text-align: center;">  </div>
WIDTH (WID)	<ol style="list-style-type: none"> 1. Call up the adjustment mode display, then select the item WID. 2. Press the VOLUME ▲ or ▼ button to get the picture so the left and right edges of raster begins to lack. 3. Press the VOLUME ▲ or ▼ button to advance the data by 7 steps. <p>Note : Check the horizontal picture position is correct.</p>
E-W PARABOLA (DPC)	<ol style="list-style-type: none"> 1. Call up the adjustment mode display, then select the item DPC. 2. Press the TV/VIDEO button on Remote until the cross-hatch pattern appears on the screen. 3. Press the VOLUME ▲ or ▼ button to make vertical lines straight as shown below. <div style="text-align: center;">  </div>

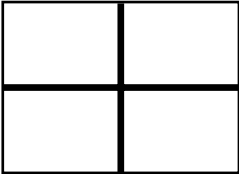
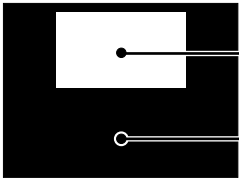
ITEM	ADJUSTMENT PROCEDURE																		
HORIZONTAL POSITION (HPOS) VERTICAL POSITION (VPOS)	<ol style="list-style-type: none"> 1. Call up the adjustment mode display, then select the item HPOS or VPOS. 2. Press the TV/VIDEO button on Remote until the white cross-bar or black cross-bar pattern appears on the screen. 3. Adjust the HORIZONTAL and VERTICAL position alternately by pressing the VOLUME ▲ or ▼ button for proper picture position. 4. Check the picture with off-air signal. 																		
HEIGHT (HIT)	<ol style="list-style-type: none"> 1. Call up the adjustment mode display, then select the item HIT. 2. Press the VOLUME ▲ or ▼ button to get the picture so the top of raster begins to lack. 3. Press the VOLUME ▲ button to advance the data by 9 steps. <p>Note : Check the vertical picture position is correct.</p>																		
WHITE BALANCE (RCUT) (GCUT) (BCUT) (GDRV) (BDRV)	<ol style="list-style-type: none"> 1. Adjust the CONTRAST control to the center, and BRIGHTNESS control to the maximum. 2. Call up the adjustment mode display, and press the TV/VIDEO button on Remote until the white and black pattern appears on the screen. 3. Adjust the following item with the CHANNEL ▲/▼ and VOLUME ▲/▼ buttons. <table style="margin-left: 40px; border: none;"> <tr> <td>RCUT</td><td>→</td><td>Data : 40H</td> <td>GDRV</td><td>→</td><td>Data : 40H</td> </tr> <tr> <td>GCUT</td><td>→</td><td>Data : 40H</td> <td>BDRV</td><td>→</td><td>Data : 40H</td> </tr> <tr> <td>BCUT</td><td>→</td><td>Data : 40H</td> <td></td><td></td><td></td> </tr> </table> 4. Press the TV/VIDEO button on TV to display a single horizontal line on the screen. 5. Turn the SCREEN control (FBT) fully counterclockwise and gradually rotate clockwise until the first horizontal line appears slightly on the screen. 6. Press the TV/VIDEO button to display the normal picture. 7. Adjust the remaining two “?CUT” items (CHANNEL ▲/▼ → TV/VIDEO → VOLUME ▲/▼ in order) to obtain the slightly lighted horizontal line in the same levels of three (red, green, blue) colors. The line should be white if the adjustments are proper.  <p>Bright area Adjust "GDRV" or "BDRV" to be white.</p> <p>Dark area Fine adjust "RCUT", "GCUT" or "BCUT" to be black.</p>	RCUT	→	Data : 40H	GDRV	→	Data : 40H	GCUT	→	Data : 40H	BDRV	→	Data : 40H	BCUT	→	Data : 40H			
RCUT	→	Data : 40H	GDRV	→	Data : 40H														
GCUT	→	Data : 40H	BDRV	→	Data : 40H														
BCUT	→	Data : 40H																	
PIP SUB-BRIGHTNESS (PBOF)	Adjust to match the PIP screen to the brightness, white balance and tint of the main picture.																		
PIP WHITE BALANCE (PGOF, PROF)																			
PIP SUB-TINT (PHUE)																			

CIRCUIT CHECKS

HIGH VOLTAGE CHECK

CAUTION: There is no HIGH VOLTAGE ADJUSTMENT on this chassis. Checking should be done following the steps below.

1. Connect an accurate high voltage meter to the second anode of the picture tube.
2. Turn on the receiver. Set the BRIGHTNESS and CONTRAST controls to minimum (zero beam current).
3. High voltage must be measured below (B) kV.

Refer to table-1 for high voltage (B).
(See SETTING & ADJUSTING DATA on page 13)

4. Vary the BRIGHTNESS control to both extremes to be sure the high voltage does not exceed the limit under any conditions.

FS CIRCUIT CHECK

The Fail Safe (FS) circuit check is indispensable for the final check in servicing. Checking should be done following the steps below.

1. Turn the receiver on and press the RESET button.
2. Temporarily short TP-(R) and TP-(X) with a jumper wire. Raster and sound will disappear.
3. The receiver must remain in this state even after removing the jumper wire. This is the evidence that the FS circuit is functioning properly.
4. To obtain a picture again, temporarily turn the receiver off and allow the FS circuit more than 5 seconds to reset. Then turn the power switch on to produce a normal picture.

Troubleshooting Guide for Fail Safe Circuit

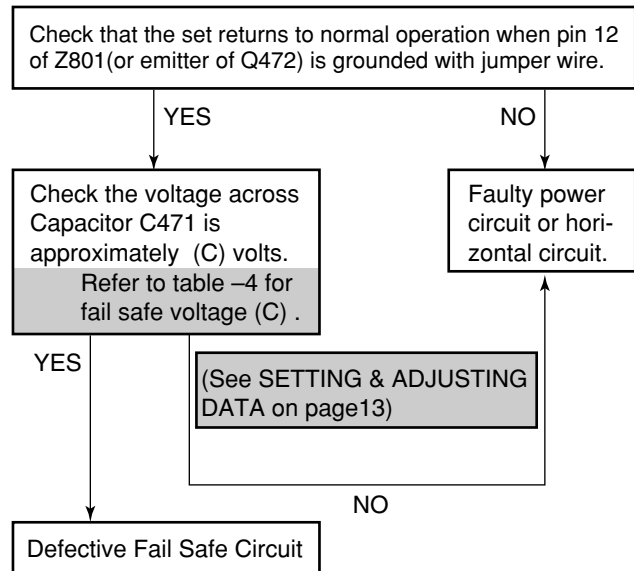

CHAPTER 2 SPECIFIC INFORMATIONS

SETTING & ADJUSTING DATA

【 SAFETY INSTRUCTIONS 】

		32"
HIGH VOLTAGE AT ZERO BEAM:	(A)	32.7kV
MAX HIGH VOLTAGE:	(B)	34.1kV

Table-1

【 SERVICE MODE 】

ADJUSTING ITEMS AND DATAS IN THE SERVICE MODE:

Item	Name of adjustment	Preset	Data	Item	Name of adjustment	Preset	Data
RCUT	R CUTOFF	40H	←	HIT	HEIGHT	20H	←
GCUT	G CUTOFF	40H	←	LIN	V-LINEARITY	08H	08H
BCUT	B CUTOFF	40H	←	VSC	V-S CORRECTION	04H	04H
GDRV	G DRIVE	40H	←	VPS	V-SHIFT	01H	←
BDRV	B DRIVE	40H	←	VCP	V-COMPENSATION	03H	←
SCNT	SUB-CONTRAST	0AH	←	WID	PICTURE WIDTH	17H	17H
BRTC	SUB-BRIGHT	40H	←	DPC	E-W PARABOLA (DPC)	0CH	0CH
COLC	SUB-COLOR	3AH	←	CNR	E-W CORNER	02H	02H
TNTC	SUB-TINT	44H	←	TRAP	TRAPEZIUM	06H	06H
SAVC	SAP VCO	20H	←	HCP	H-COMPENSATION	00H	←
ATT	ATTENUATOR	20H	←	VFC	V-F CORRECTION	0FH	←
STVC	STEREO VCO	20H	←	PCOL	PIP COLOR	0FH	←
STRF	STEREO FILTER	20H	←	PHUE	PIP TINT	11H	←
SPEC	SPECTRAL	20H	←	PGOF	PIP	36H	←
WBAN	STEREO SEPARATION	20H	←	PROF	PIP	17H	←
HPOS	HORIZ. POSITION	16H	←	PBOF	PIP	17H	←
VPOS	VERT. POSITION	03H	←	RGBB	RGB BRIGHT	0BH	←

Table-2

【 DESIGN MODE 】

ADJUSTING ITEMS AND DATAS IN THE DESIGN MODE:

Item	Name of adjustment	Preset Data	Data	Remarks
OPT1	OPTION1	84H	84H	
OPT2	OPTION2	01H	01H	

Table-3

【 CIRCUIT CHECKS 】

		32"
FAIL SAFE DET. VOLTAGE	(C)	22.35 V

Table-4

LOCATION OF CONTROLS (Representative:32AF44)

Front View

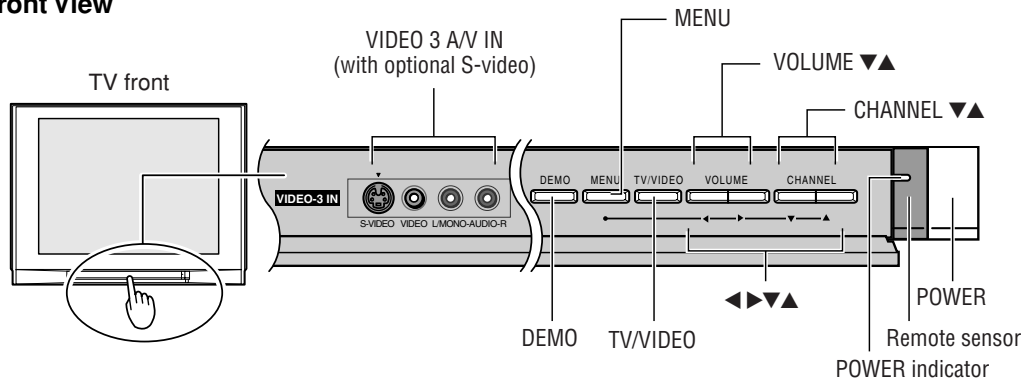

Rear Term

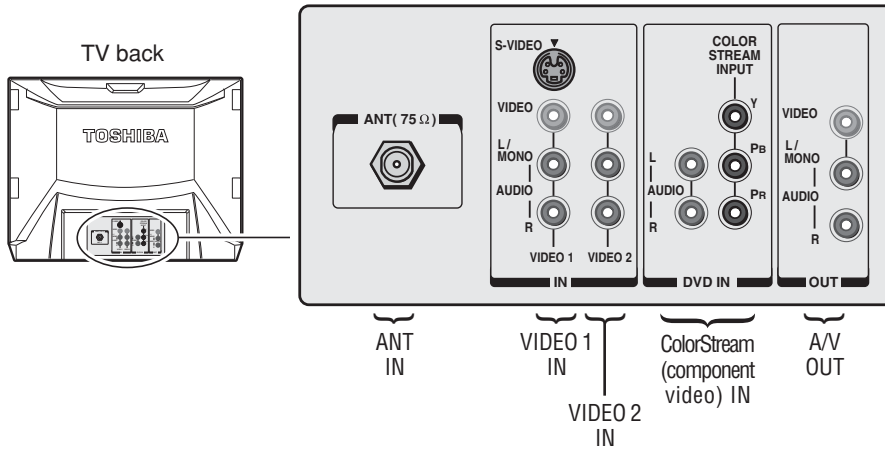

Remote Control

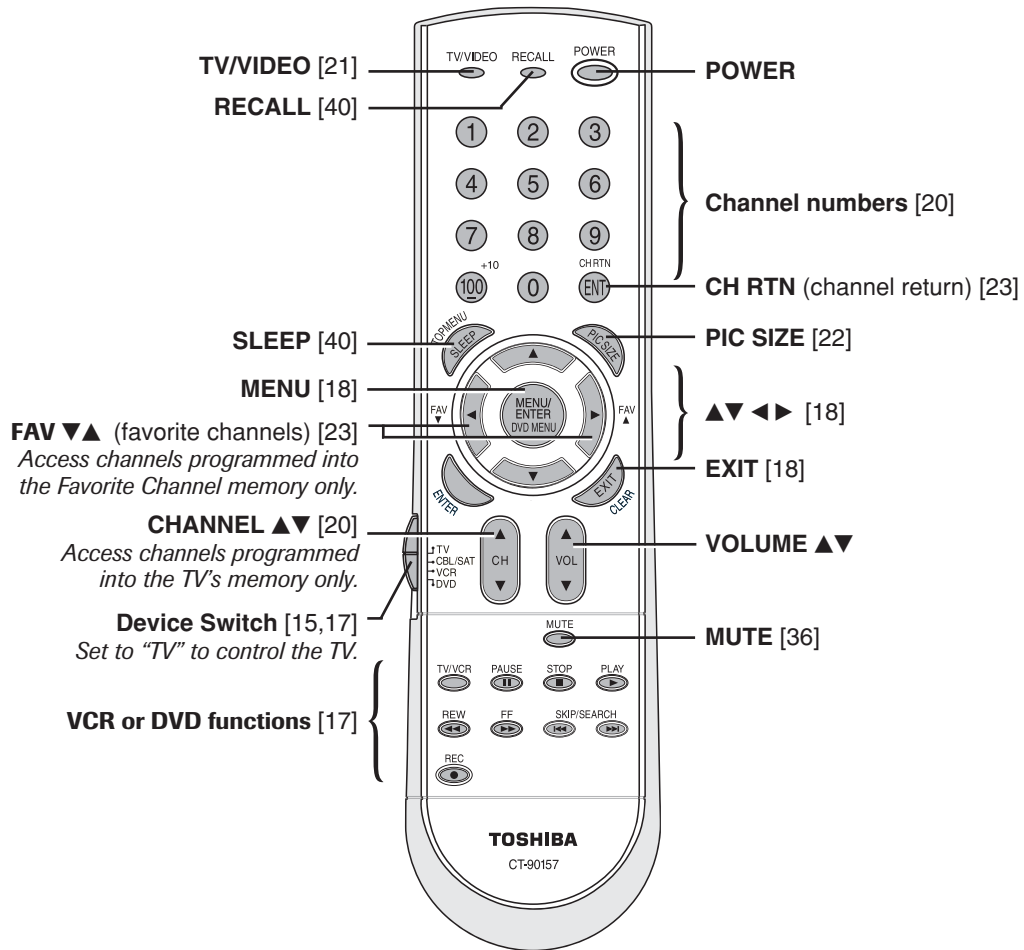

PROGRAMMING CHANNEL MEMORY

When you press CHANNEL ▲ or ▼ on the remote control or TV front panel, your TV will stop only on the channels stored in the channel memory. Follow the steps below and on the next page to program channels into the channel memory.

Programming channels automatically

Your TV can automatically detect all active channels in your area and store them in the channel memory. After the channels are stored automatically, you can manually add or erase individual channels

To program channels automatically:

1. Press MENU, and then press ◀ or ▶ until the SET UP menu appears.
2. Press ▲ or ▼ until TV/CABLE is highlighted.
3. Press ◀ or ▶ to highlight either TV (if you use an antenna) or CABLE (if you have cable service).
4. Press ▼ to highlight CH PROGRAM.

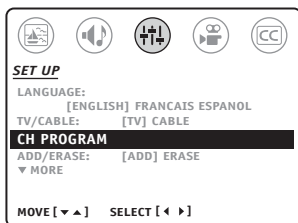
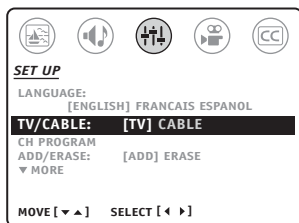

5. Press ◀ or ▶ to start channel programming. The TV will automatically cycle through all the TV or CABLE channels (depending on which you selected), and store all active channels in the channel memory.

While the TV is cycling through the channels, the message "CH PROGRAM" appears.

6. When channel programming is complete, the message "CH PROGRAMMING COMPLETED" appears.
7. Press CHANNEL ▲ or ▼ to view the programmed channels.

Adding and erasing channels manually

After you automatically program the channels into the channel memory (see previous page), you can manually add or erase specific channels.

To manually add or erase channels:

1. Select the channel you want to add or erase. If you are adding a channel, you must select the channel using the Channel Number buttons on the remote control.
2. Press MENU, and then press ◀ or ▶ until the SET UP menu appears.
3. Press ▲ or ▼ to highlight ADD/ERASE.

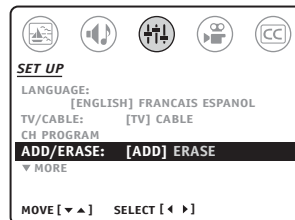

4. Press ◀ or ▶ to select ADD or ERASE, depending on the function you want to perform.
5. Repeat steps 1–4 for other channels you want to add or erase.

CHASSIS AND CABINET REPLACEMENT PARTS LIST

WARNING: BEFORE SERVICING THIS CHASSIS, READ THE "X-RAY RADIATION PRECAUTION", "SAFETY PRECAUTION" AND "PRODUCT SAFETY NOTICE" ON PAGE 3 OF THIS MANUAL.

CAUTION: The international hazard symbols "⚠" in the schematic diagram and the parts list designate components which have special characteristics important for safety and should be replaced only with types identical to those in the original circuit or specified in the parts list. The mounting position of replacements is to be identical with originals. Before replacing any of these components, read carefully the PRODUCT SAFETY NOTICE. Do not degrade the safety of the receiver through improper servicing.

NOTICE:

- The part number must be used when ordering parts, in order to assist in processing, be sure to include the Model number and Description.
- The PC board assembly with * mark is no longer available after the end of the production.

Model : 32AF44/32AFX54

Capacitors	CD : Ceramic Disk	PF : Plastic Film	EL : Electrolytic
Resistors	CF : Carbon Film	CC : Carbon Composition	MF : Metal Film
	OMF : Oxide Metal Film	VR : Variable Resistor	FR : Fusible Resistor

(All CD and PF capacitors are ±5%, 50V and all resistors, ±5%, 1/6W unless otherwise noted.)

Location No.	Parts No.	Description
#1:[32AF44]		
#2:[32AFX54]		
CAPACITORS		
C102	24792471	ELECTROLYTIC, 6.3V 470UF M
C105	24212102	CERAMIC DISC, 50V B 1000PF K
C106	24797479	ELECTROLYTIC, 50V 4.7UF M
C107	24763221	ELECTROLYTIC, 16V 220UF M
C201	24539104	PLASTIC FILM, 50V 0.1UF J
C204	24797010	ELECTROLYTIC, 50V 1UF M
C205	24794100	ELECTROLYTIC, 16V 10UF M
C213	24503041	PLASTIC FILM, 63V 0.1UF J
C216	24794100	ELECTROLYTIC, 16V 10UF M
C220	24539474	PLASTIC FILM, 50V 0.47UF J
C221	24109103	CERAMIC CHIP, 50V B 0.01UF K
C222	24109103	CERAMIC CHIP, 50V B 0.01UF K
C223	24109103	CERAMIC CHIP, 50V B 0.01UF K
C224	24539104	PLASTIC FILM, 50V 0.1UF J
C225	24539104	PLASTIC FILM, 50V 0.1UF J
C226	24539104	PLASTIC FILM, 50V 0.1UF J
C245	24206108	ELECTROLYTIC 04W, 50V 0.1UF M 7L 3A
C261	24539104	PLASTIC FILM, 50V 0.1UF J
C262	24539104	PLASTIC FILM, 50V 0.1UF J
C263	24539104	PLASTIC FILM, 50V 0.1UF J
C271	24109561	CERAMIC CHIP, 50V B 560PF K
C304	24693273	PLASTIC FILM, 100V 0.027UF J
C305	24617915	ELECTROLYTIC, 50V 1UF K 3A LI
C306	24073059	ELECTROLYTIC, 25V 3300UF M 3A
C308	24668221	ELECTROLYTIC, 35V 220UF M 3A
C309	24436101	CERAMIC DISC, 50V SL 100PF J
C310	24766102	ELECTROLYTIC, 50V 1000UF M
C311	24214152	CERAMIC DISC, 500V B 1500PF K
C313	24082057	PLASTIC FILM, 100V 0.22UF J
C314	24436680	CERAMIC DISC, 50V SL 68PF J
	24436680	CERAMIC DISC, 50V SL 68PF J
C315	24109102	CERAMIC CHIP, 50V B 1000PF K
C317	24214471	CERAMIC DISC, 500V B 470PF K
C319	24109273	CERAMIC CHIP, 25V B 0.027UF K
C320	24797101	ELECTROLYTIC, 50V 100UF M
C323	24539474	PLASTIC FILM, 50V 0.47UF J
C324	24503037	MT PLA CAP 63V 0.047UF J

Location No.	Parts No.	Description
C325	24539683	PLASTIC FILM, 50V 0.068UF J
C326	24539104	PLASTIC FILM, 50V 0.1UF J
C327	24617915	ELECTROLYTIC, 50V 1UF K 3A LI
C337	24797229	ELECTROLYTIC, 50V 2.2UF M
C370	24794101	ELECTROLYTIC, 16V 100UF M
C371	24794100	ELECTROLYTIC, 16V 10UF M
C403	24539103	PLASTIC FILM, 50V 0.01UF J
C404	24797010	ELECTROLYTIC, 50V 1UF M
C407	24539104	PLASTIC FILM, 50V 0.1UF J
C408	24109273	CERAMIC CHIP, 25V B 0.027UF K
C410	24109103	CERAMIC CHIP, 50V B 0.01UF K
C412	24214472	CERAMIC DISC, 500V B 4700PF K
C413	24214821	CERAMIC DISC, 500V B 820PF K
C415	24539224	PLASTIC FILM, 50V 0.22UF J
C416	24678010	ELECTROLYTIC, 200V 1UF M 3A
C417	24214331	CERAMIC DISC, 500V B 330PF K
C430	24109103	CERAMIC CHIP, 50V B 0.01UF K
C431	24794101	ELECTROLYTIC, 16V 100UF M
C439	24503125	PLASTIC FILM, 400V 0.075UF J
C441	24503305	PLASTIC FILM CF92 T 315V R62UF J
⚠ C442	24503298	PLASTIC FILM, 315V 0.3UF J
⚠ C443	24503274	PLASTIC FILM CF92 T 1500VH 7800PF H
⚠ C444	24503080	PLASTIC FILM CF92 T 1800VH 7500PF H
C445	24828563	PLASTIC FILM, 200V 56000PF J
C446	24679100	ELECTROLYTIC, 250V 10UF M 3A
C448	24640908	ELECTROLYTIC, 160V 33UF M 3A LI
C451	24085981	ELEC. NONPOLAR CE04J 16V 10UF M 11L NP
C457	24591222	PLASTIC FILM, 50V 2200PF J
C463	24212152	CERAMIC DISC, 50V B 1500PF K
C464	24640872	ELECTROLYTIC, 100V 10UF M 3A
C466	24503037	MT PLA CAP 63V 0.047UF J
⚠ C467	24820273	PLASTIC FILM, 630V 27000PF J
⚠ C469	24820243	PLASTIC FILM CQ92 T 630V 24000PF
C471	24797479	ELECTROLYTIC, 50V 4.7UF M
C474	24794100	ELECTROLYTIC, 16V 10UF M
C480	24747220	ELECTROLYTIC, 50V 22UF M 7L 3A
C481	24539474	PLASTIC FILM, 50V 0.47UF J
C482	24797478	ELECTROLYTIC, 50V 0.47UF M
C483	24206108	ELECTROLYTIC 04W, 50V 0.1UF M 7L 3A
C499	24212102	CERAMIC DISC, 50V B 1000PF K
C501	24109102	CERAMIC CHIP, 50V B 1000PF K

Location No.	Parts No.	Description
C504	24591222	PLASTIC FILM, 50V 2200PF J
C505	24105130	CERAMIC CHIP, 50V CH 13PF J
C510	24109103	CERAMIC CHIP, 50V B 0.01UF K
C511	24794101	ELECTROLYTIC, 16V 100UF M
C512	24206228	ELECTROLYTIC, 50V 0.22UF M 7L 3A CE04WS
C582	24109103	CERAMIC CHIP, 50V B 0.01UF K
C583	24762471	ELECTROLYTIC, 04G 10V 470UF M
C614	24794470	ELECTROLYTIC, 16V 47UF M
C615	24092730	CERAMIC CHIP, 16V B 0.1UF K
C661	24109102	CERAMIC CHIP, 50V B 1000PF K
C662	24212102	CERAMIC DISC, 50V B 1000PF K
C663	24794100	ELECTROLYTIC, 16V 10UF M
C672	24667470	ELECTROLYTIC CE04Q, 25V 47UF M 3A
C673	24797229	ELECTROLYTIC, 50V 2.2UF M
C674	24669010	ELECTROLYTIC, 50V 1UF M 3A
C675	24669010	ELECTROLYTIC, 50V 1UF M 3A
C676	24285104	CERAMIC CHIP, 50V B 0.1UF K
C677	24503041	PLASTIC FILM , 63V 0.1UF J
C678	24797229	ELECTROLYTIC, 50V 2.2UF M
C681	24668102	ELECTROLYTIC, 35V 1000UF M 3A
C682	24669221	ELECTROLYTIC, 50V 220UF M 3A
C683	24668102	ELECTROLYTIC, 35V 1000UF M 3A
C684	24100103	CERAMIC CHIP, 50V F 0.01UF Z
C704	24232103	CERAMIC DISC, 50V F 0.01UF Z
C705	24232103	CERAMIC DISC, 50V F 0.01UF Z
C707	24794101	ELECTROLYTIC, 16V 100UF M
C713	24709100	ELECTROLYTIC, 200V 10UF M
C714	24436101	CERAMIC DISC, 50V SL 100PF J
C715	24214472	CERAMIC DISC, 500V B 4700PF K
C716	24436101	CERAMIC DISC, 50V SL 100PF J
C717	24214472	CERAMIC DISC, 500V B 4700PF K
C718	24794470	ELECTROLYTIC, 16V 47UF M
C719	24435560	CERAMIC DISC, 500V SL 56PF J
C720	24709100	ELECTROLYTIC, 200V 10UF M
C721	24794470	ELECTROLYTIC, 16V 47UF M
C726	24212102	CERAMIC DISC, 50V B 1000PF K
△C801	24503002	PLASTIC FILM, AC275V 0.22UF M
△C802	24503001	PLASTIC FILM, AC275V 0.1UF M
C805	24092623	CERAMIC DISC, 250V F 0.01UF Z
C806	24092623	CERAMIC DISC, 250V F 0.01UF Z
C808	24667221	ELECTROLYTIC CE04Q, 25V 220UF M 3A
C810	24086061	ELECTROLYTIC, 200V 470UF M 3F
△C811	24092581	CERAMIC DISC, AC250V E 1000PF M
△C812	24092581	CERAMIC DISC, AC250V E 1000PF M
△C813	24092583	CERAMIC DISC, AC250V E 2200PF M
C817	24092339	CERAMIC DISC, 2KV 330PF K
C818	24503237	PLASTIC FILM CF92 T 1250VH 2200PF H
C821	24214471	CERAMIC DISC, 500V B 470PF K
C822	24590223	PLASTIC FILM, 50V 0.022UF J
C823	24212471	CERAMIC DISC, 50V B 470PF K
C829	24591152	PLASTIC FILM, 50V 1500PF J
C830	24503047	PLASTIC FILM, 63V 0.33UF J
C831	24503047	PLASTIC FILM, 63V 0.33UF J
C832	24503047	PLASTIC FILM, 63V 0.33UF J
C834	24503047	PLASTIC FILM, 63V 0.33UF J
C840	24795221	ELECTROLYTIC CE04G, 25V 220UF M
C842	24792101	ELECTROLYTIC CE04G, 6.3V 100UF M
C843	24797479	ELECTROLYTIC, 50V 4.7UF M
C884	24086052	ELECTROLYTIC, 200V 220UF M 22A
C886	24214471	CERAMIC DISC, 500V B 470PF K
C889	24796222	ELECTROLYTIC, 35V 2200UF M
C890	24214471	CERAMIC DISC, 500V B 470PF K
C891	24503041	PLASTIC FILM , 63V 0.1UF J
C893	24092339	CERAMIC DISC, 2KV 330PF K
C896	24794471	ELECTROLYTIC, 16V 470UF M
C897	24794222	ELECTROLYTIC, 16V 2200UF M

Location No.	Parts No.	Description
C902	24092353	CERAMIC DISC, 2KV 4700PF K
C904	24436331	CERAMIC DISC, 50V SL 330PF J
C905	24436331	CERAMIC DISC, 50V SL 330PF J
C907	24436331	CERAMIC DISC, 50V SL 330PF J
C909	24679220	ELECTROLYTIC, 250V 22UF M 3A
C910	24797478	ELECTROLYTIC, 50V 0.47UF M
C911	24794100	ELECTROLYTIC, 16V 10UF M
C912	24763471	ELECTROLYTIC, 16V 470UF M
C913	24794100	ELECTROLYTIC, 16V 10UF M
C914	24232103	CERAMIC DISC, 50V F 0.01UF Z
C920	24232103	CERAMIC DISC, 50V F 0.01UF Z
C921	24232103	CERAMIC DISC, 50V F 0.01UF Z
C930	24214101	CERAMIC DISC, 500V B 100PF K
C970	24794470	ELECTROLYTIC, 16V 47UF M
C971	24794470	ELECTROLYTIC, 16V 47UF M
C972	24794470	ELECTROLYTIC, 16V 47UF M
C2701	24109103	CERAMIC CHIP, 50V B 0.01UF K
C2702	24539474	PLASTIC FILM, 50V 0.47UF J
C2703	24109472	CERAMIC CHIP, 50V B 4700PF K
C2704	24794100	ELECTROLYTIC, 16V 10UF M
C2707	24105150	CERAMIC CHIP, 50V CH 15PF J
C2710	24109103	CERAMIC CHIP, 50V B 0.01UF K
C2711	24794100	ELECTROLYTIC, 16V 10UF M
C2715	24109103	CERAMIC CHIP, 50V B 0.01UF K
CA03	24105471	CERAMIC CHIP, 50V CH 470PF J
CA04	24105471	CERAMIC CHIP, 50V CH 470PF J
CA05	24105471	CERAMIC CHIP, 50V CH 470PF J
CA06	24105471	CERAMIC CHIP, 50V CH 470PF J
CA32	24100104	CERAMIC CHIP, 25V F 0.1UF Z
CA37	24105101	CERAMIC CHIP, 50V CH 100PF J
CA38	24105101	CERAMIC CHIP, 50V CH 100PF J
CA42	24794100	ELECTROLYTIC, 16V 10UF M
CA43	24109103	CERAMIC CHIP, 50V B 0.01UF K
CA44	24109103	CERAMIC CHIP, 50V B 0.01UF K
CA68	24794100	ELECTROLYTIC, 16V 10UF M
CA69	24109103	CERAMIC CHIP, 50V B 0.01UF K
CB01	24794470	ELECTROLYTIC, 16V 47UF M
CB41	24763221	ELECTROLYTIC, 16V 220UF M
CB48	24105101	CERAMIC CHIP, 50V CH 100PF J
CB60	24085944	ELECTROLYTIC, NONPOLAR, 50V 2.2UF M 11L
CB61	24591102	PLASTIC FILM, 50V 1000PF J
CB62	24109561	CERAMIC CHIP, 50V B 560PF K
CB63	24109122	CERAMIC CHIP, 50V B 1200PF K
CB64	24763471	ELECTROLYTIC, 16V 470UF M
CB65	24100104	CERAMIC CHIP, 25V F 0.1UF Z
CD41	24109332	CERAMIC CHIP, 50V B 3300PF K
CD42	24109333	CERAMIC CHIP CK73B 25V 33000PFK
CD43	24797479	ELECTROLYTIC, 50V 4.7UF M
CD44	24797479	ELECTROLYTIC, 50V 4.7UF M
CD45	24109182	CERAMIC CHIP, 50V B 1800PF K
CD46	24092753	CERAMIC CHIP, 10V B 0.22UF K
CD47	24109103	CERAMIC CHIP, 50V B 0.01UF K
CD48	24794100	ELECTROLYTIC, 16V 10UF M
CD49	24092730	CERAMIC CHIP, 16V B 0.1UF K
CD50	24797479	ELECTROLYTIC, 50V 4.7UF M
CD51	24797479	ELECTROLYTIC, 50V 4.7UF M
CD52	24100104	CERAMIC CHIP, 25V F 0.1UF Z
CD53	24794221	ELECTROLYTIC 04G, 16V 220UF M
CD54	24797479	ELECTROLYTIC, 50V 4.7UF M
CD55	24797479	ELECTROLYTIC, 50V 4.7UF M
CD56	24797479	ELECTROLYTIC, 50V 4.7UF M
CD57	24092730	CERAMIC CHIP, 16V B 0.1UF K
CD58	24109103	CERAMIC CHIP, 50V B 0.01UF K
CD59	24092753	CERAMIC CHIP, 10V B 0.22UF K
CD60	24109182	CERAMIC CHIP, 50V B 1800PF K
CD61	24797479	ELECTROLYTIC, 50V 4.7UF M

Location No.	Parts No.	Description
CD62	24797479	ELECTROLYTIC, 50V 4.7UF M
CD63	24109333	CERAMIC CHIP CK73B 25V 33000PFK
CD64	24109332	CERAMIC CHIP, 50V B 3300PF K
CD86	24797100	ELECTROLYTIC, 50V 10UF M
CD88	24797100	ELECTROLYTIC, 50V 10UF M
CD90	24797100	ELECTROLYTIC, 50V 10UF M
CD91	24797100	ELECTROLYTIC, 50V 10UF M
CG01	24794100	ELECTROLYTIC, 16V 10UF M
CG02	24092730	CERAMIC CHIP, 16V B 0.1UF K
CG03	24794100	ELECTROLYTIC, 16V 10UF M
CG04	24109123	CERAMIC CHIP CK73B 50V 12000PF K
CG05	24092730	CERAMIC CHIP, 16V B 0.1UF K
CG06	24797479	ELECTROLYTIC, 50V 4.7UF M
CG07	24794100	ELECTROLYTIC, 16V 10UF M
CG08	24794100	ELECTROLYTIC, 16V 10UF M
CG09	24797479	ELECTROLYTIC, 50V 4.7UF M
CG10	24794101	ELECTROLYTIC, 16V 100UF M
CG11	24794100	ELECTROLYTIC, 16V 10UF M
CG12	24797479	ELECTROLYTIC, 50V 4.7UF M
CG13	24794100	ELECTROLYTIC, 16V 10UF M
CG14	24109272	CERAMIC CHIP, 50V B 2700PF K
CG15	24109473	CERAMIC CHIP, 25V B 0.047UF K
CG16	24704335	TA SOLID ELEC.CS15H 16V 3.3UF M
CG17	24794100	ELECTROLYTIC, 16V 10UF M
CG18	24088094	CHIP TA SOLID, 20V 10UF M B2-CAS
CG19	24797010	ELECTROLYTIC, 50V 1UF M
CG22	24109223	CERAMIC CHIP, 25V B 0.022UF K
CG23	24109472	CERAMIC CHIP, 50V B 4700PF K
CG24	24794100	ELECTROLYTIC, 16V 10UF M
CG25	24092730	CERAMIC CHIP, 16V B 0.1UF K
CG26	24109472	CERAMIC CHIP, 50V B 4700PF K
CG27	24794100	ELECTROLYTIC, 16V 10UF M
CG28	24794100	ELECTROLYTIC, 16V 10UF M
CG29	24092730	CERAMIC CHIP, 16V B 0.1UF K
CG30	24794100	ELECTROLYTIC, 16V 10UF M
CG31	24794100	ELECTROLYTIC, 16V 10UF M
CG32	24794100	ELECTROLYTIC, 16V 10UF M
CG33	24794100	ELECTROLYTIC, 16V 10UF M
CG40	24109562	CERAMIC CHIP, 50V B 5600PF K
CI01	24109103	CERAMIC CHIP, 50V B 0.01UF K
CI02	24109103	CERAMIC CHIP, 50V B 0.01UF K
CI03	24109103	CERAMIC CHIP, 50V B 0.01UF K
CI04	24109103	CERAMIC CHIP, 50V B 0.01UF K
CI05	24109103	CERAMIC CHIP, 50V B 0.01UF K
CI07	24109103	CERAMIC CHIP, 50V B 0.01UF K
CI08	24797010	ELECTROLYTIC, 50V 1UF M
CI09	24105470	CERAMIC CHIP, 50V CH 47PF J
CI10	24105180	CERAMIC CHIP, 50V CH 18PF J
CI11	24105270	CERAMIC CHIP, 50V CH 27PF J
CI12	24797478	ELECTROLYTIC, 50V 0.47UF M
CI13	24109102	CERAMIC CHIP, 50V B 1000PF K
CI14	24105470	CERAMIC CHIP, 50V CH 47PF J
CI15	24105390	CERAMIC CHIP, 50V CH 39PF J
CI16	24109103	CERAMIC CHIP, 50V B 0.01UF K
CI17	24092726	CERAMIC CHIP CK733B 16V 2,200,000PFK
CI18	24105181	CERAMIC CHIP, 50V CH 180PF J
CI21	24109103	CERAMIC CHIP, 50V B 0.01UF K
CI23	24109103	CERAMIC CHIP, 50V B 0.01UF K
CI25	24105240	CERAMIC CHIP, 50V CH 24PF J
CI51	24797220	ELECTROLYTIC, 50V 22UF M
CI52	24794101	ELECTROLYTIC, 16V 100UF M
CI53	24797339	ELECTROLYTIC CE04G, 50V 3.3UF M
CM51	24539104	PLASTIC FILM, 50V 0.1UF J
CM52	24105331	CERAMIC CHIP, 50V CH 330PF J
CM58	24539104	PLASTIC FILM, 50V 0.1UF J
CR01	24100104	CERAMIC CHIP, 25V F 0.1UF Z

Location No.	Parts No.	Description
CR02	24100104	CERAMIC CHIP, 25V F 0.1UF Z
CR03	24100104	CERAMIC CHIP, 25V F 0.1UF Z
CS02	24797229	ELECTROLYTIC, 50V 2.2UF M
CS04	24797229	ELECTROLYTIC, 50V 2.2UF M
CS05	24797100	ELECTROLYTIC, 50V 10UF M
CS06	24797100	ELECTROLYTIC, 50V 10UF M
CS14	24797229	ELECTROLYTIC, 50V 2.2UF M
CS16	24797229	ELECTROLYTIC, 50V 2.2UF M
CS25	24797229	ELECTROLYTIC, 50V 2.2UF M
CS26	24797229	ELECTROLYTIC, 50V 2.2UF M
CS40	24797010	ELECTROLYTIC, 50V 1UF M
CS42	24797010	ELECTROLYTIC, 50V 1UF M
CS43	24105331	CERAMIC CHIP, 50V CH 330PF J
CS44	24105331	CERAMIC CHIP, 50V CH 330PF J
CS45	24109331	CERAMIC CHIP, 50V B 330PF K
CS46	24109331	CERAMIC CHIP, 50V B 330PF K
CS47	24105331	CERAMIC CHIP, 50V CH 330PF J
CS48	24105331	CERAMIC CHIP, 50V CH 330PF J
CS49	24105331	CERAMIC CHIP, 50V CH 330PF J
CS60	24105331	CERAMIC CHIP, 50V CH 330PF J
CS61	24109102	CERAMIC CHIP, 50V B 1000PF K
CS62	24109102	CERAMIC CHIP, 50V B 1000PF K
CS70	24794220	ELECTROLYTIC, 16V 22UF M
CS71	24794220	ELECTROLYTIC, 16V 22UF M
CS115	24797010	ELECTROLYTIC, 50V 1UF M
CS116	24797010	ELECTROLYTIC, 50V 1UF M
CS118	24794470	ELECTROLYTIC, 16V 47UF M
CS120	24797010	ELECTROLYTIC, 50V 1UF M
CV03	24206108	ELECTROLYTIC 04W, 50V 0.1UF M 7L 3A
CV05	24109103	CERAMIC CHIP, 50V B 0.01UF K
CV09	24503041	PLASTIC FILM , 63V 0.1UF J
CV13	24206108	ELECTROLYTIC 04W, 50V 0.1UF M 7L 3A
CV15	24109103	CERAMIC CHIP, 50V B 0.01UF K
CV24	24109473	CERAMIC CHIP, 25V B 0.047UF K
CV25	24794220	ELECTROLYTIC, 16V 22UF M
CV27	24092730	CERAMIC CHIP, 16V B 0.1UF K
CV29	24109103	CERAMIC CHIP, 50V B 0.01UF K
CV31	24092730	CERAMIC CHIP, 16V B 0.1UF K
CV38	24763471	ELECTROLYTIC, 16V 470UF M
CV39	24109103	CERAMIC CHIP, 50V B 0.01UF K
CV41	24092730	CERAMIC CHIP, 16V B 0.1UF K
CV61	24762471	ELECTROLYTIC, 04G 10V 470UF M
CZ01	24794101	ELECTROLYTIC, 16V 100UF M
CZ02	24109103	CERAMIC CHIP, 50V B 0.01UF K
CZ03	24794100	ELECTROLYTIC, 16V 10UF M
CZ04	24105181	CERAMIC CHIP, 50V CH 180PF J
CZ05	24105680	CERAMIC CHIP, 50V CH 68PF J
CZ06	24105330	CERAMIC CHIP, 50V CH 33PF J
CZ08	24100104	CERAMIC CHIP, 25V F 0.1UF Z
CZ09	24109103	CERAMIC CHIP, 50V B 0.01UF K
CZ10	24794101	ELECTROLYTIC, 16V 100UF M
CZ12	24105101	CERAMIC CHIP, 50V CH 100PF J
CZ13	24105121	CERAMIC CHIP, 50V CH 120PF J
CZ14	24105151	CERAMIC CHIP, 50V CH 150PF J
CZ15	#1 24092442	CERAMIC CHIP, 16V F 0.47UF Z
CZ16	#1 24109103	CERAMIC CHIP, 50V B 0.01UF K
CZ17	#1 24109103	CERAMIC CHIP, 50V B 0.01UF K
CZ19	#1 24108181	CERAMIC CHIP, 50V SL 180PF J
CZ20	#1 24109103	CERAMIC CHIP, 50V B 0.01UF K
CZ21	#1 24109122	CERAMIC CHIP, 50V B 1200PF K
CZ22	#1 24794100	ELECTROLYTIC, 16V 10UF M
CZ23	#1 24109103	CERAMIC CHIP, 50V B 0.01UF K
CZ24	#1 24109103	CERAMIC CHIP, 50V B 0.01UF K
CZ25	#1 24794100	ELECTROLYTIC, 16V 10UF M
CZ26	#1 24109103	CERAMIC CHIP, 50V B 0.01UF K
CZ27	#1 24109103	CERAMIC CHIP, 50V B 0.01UF K

Location No.	Parts No.	Description
CZ28 #1	24109103	CERAMIC CHIP, 50V B 0.01UF K
CZ29 #1	24109103	CERAMIC CHIP, 50V B 0.01UF K
CZ30 #1	24794100	ELECTROLYTIC, 16V 10UF M
CZ31	24092730	CERAMIC CHIP, 16V B 0.1UF K
CZ32 #1	24109103	CERAMIC CHIP, 50V B 0.01UF K
CZ33 #1	24794100	ELECTROLYTIC, 16V 10UF M
CZ38 #1	24794100	ELECTROLYTIC, 16V 10UF M
CZ41 #1	24108470	CERAMIC CHIP, 50V SL 47PF J
CZ42 #1	24108470	CERAMIC CHIP, 50V SL 47PF J
CZ45 #1	24108100	CERAMIC CHIP, 50V SL 10PF D
CZ57	24105181	CERAMIC CHIP, 50V CH 180PF J
CZ58	24105560	CERAMIC CHIP, 50V CH 56PF J
CZ96	24105270	CERAMIC CHIP, 50V CH 27PF J
CZ250 #2	24100104	CERAMIC CHIP, 25V F 0.1UF Z
CZ350 #2	24792101	ELECTROLYTIC CE04G, 6.3V 100UF M
CZ360 #2	24792101	ELECTROLYTIC CE04G, 6.3V 100UF M
CZ370 #2	24792101	ELECTROLYTIC CE04G, 6.3V 100UF M
CZ380 #2	24792101	ELECTROLYTIC CE04G, 6.3V 100UF M
CZ390 #2	24792101	ELECTROLYTIC CE04G, 6.3V 100UF M
CZ400 #2	24100104	CERAMIC CHIP, 25V F 0.1UF Z
CZ410 #2	24100104	CERAMIC CHIP, 25V F 0.1UF Z
CZ420 #2	24100104	CERAMIC CHIP, 25V F 0.1UF Z
CZ430 #2	24100104	CERAMIC CHIP, 25V F 0.1UF Z
CZ440 #2	24100104	CERAMIC CHIP, 25V F 0.1UF Z
CZ450 #2	24100104	CERAMIC CHIP, 25V F 0.1UF Z
CZ460 #2	24100104	CERAMIC CHIP, 25V F 0.1UF Z
CZ470 #2	24100104	CERAMIC CHIP, 25V F 0.1UF Z
CZ480 #2	24100104	CERAMIC CHIP, 25V F 0.1UF Z
CZ490 #2	24100104	CERAMIC CHIP, 25V F 0.1UF Z
CZ500 #2	24100104	CERAMIC CHIP, 25V F 0.1UF Z
CZ510 #2	24100104	CERAMIC CHIP, 25V F 0.1UF Z
CZ520 #2	24794100	ELECTROLYTIC, 16V 10UF M
CZ530 #2	24092730	CERAMIC CHIP, 16V B 0.1UF K
CZ540 #2	24092730	CERAMIC CHIP, 16V B 0.1UF K
CZ610 #2	24100104	CERAMIC CHIP, 25V F 0.1UF Z
CZ620 #2	24100104	CERAMIC CHIP, 25V F 0.1UF Z
CZ630 #2	24092730	CERAMIC CHIP, 16V B 0.1UF K
CZ640 #2	24105101	CERAMIC CHIP, 50V CH 100PF J
CZ650 #2	24092573	CERAMIC CHIP, 16V B 0.47UF K
CZ660 #2	24092730	CERAMIC CHIP, 16V B 0.1UF K
CZ670 #2	24092730	CERAMIC CHIP, 16V B 0.1UF K
CZ680 #2	24092730	CERAMIC CHIP, 16V B 0.1UF K
CZ690 #2	24092730	CERAMIC CHIP, 16V B 0.1UF K
CZ700 #2	24100104	CERAMIC CHIP, 25V F 0.1UF Z
CZ710 #2	24092730	CERAMIC CHIP, 16V B 0.1UF K
CZ720 #2	24092730	CERAMIC CHIP, 16V B 0.1UF K
CZ730 #2	24092730	CERAMIC CHIP, 16V B 0.1UF K
CZ740 #2	24092730	CERAMIC CHIP, 16V B 0.1UF K
CZ750 #2	24092730	CERAMIC CHIP, 16V B 0.1UF K
CZ760 #2	24092573	CERAMIC CHIP, 16V B 0.47UF K
CZ770	24092730	CERAMIC CHIP, 16V B 0.1UF K
CZ830 #2	24100104	CERAMIC CHIP, 25V F 0.1UF Z
CZ840 #2	24100104	CERAMIC CHIP, 25V F 0.1UF Z
CZ970 #2	24794101	ELECTROLYTIC, 16V 100UF M
CZ980 #2	24100104	CERAMIC CHIP, 25V F 0.1UF Z
CZ990 #2	24100104	CERAMIC CHIP, 25V F 0.1UF Z
RESISTORS		
R101	24553223	OXIDE METAL FILM, 1W 22K OHM J
R203	24011474	CHIP, METAL FILM, 1/20W 470K OHM J
R204	24011182	CHIP, METAL FILM, 1/20W 1.8K OHM J
R205	24366152	CARBON FILM, 1/6W 1.5K OHM J
R206	24011222	CHIP, METAL FILM, 1/20W 2.2K OHM J
R207	24011101	CHIP, METAL FILM, 1/20W 100 OHM J
R208	24011101	CHIP, METAL FILM, 1/20W 100 OHM J
R209	24011101	CHIP, METAL FILM, 1/20W 100 OHM J

Location No.	Parts No.	Description
R216	24366223	CARBON FILM, 1/6W 22K OHM J
R219	24366223	CARBON FILM, 1/6W 22K OHM J
R227	24366682	CARBON FILM, 1/6W 6.8K OHM J
R228	24366333	CARBON FILM, 1/6W 33K OHM J
R238	24011473	CHIP, METAL FILM, 1/20W 47K OHM J
R239	24011224	CHIP, METAL FILM, 1/20W 220K OHM J
R240	24011562	CHIP, METAL FILM, 1/20W 5.6K OHM J
R241	24011682	CHIP, METAL FILM, 1/20W 6.8K OHM J
R245	24366104	CARBON FILM, 1/6W 100K OHM J
R261	24011472	CHIP, METAL FILM, 1/20W 4.7K OHM J
R262	24011102	CHIP, METAL FILM, 1/20W 1K OHM J
R263	24011472	CHIP, METAL FILM, 1/20W 4.7K OHM J
R264	24011102	CHIP, METAL FILM, 1/20W 1K OHM J
R265	24011472	CHIP, METAL FILM, 1/20W 4.7K OHM J
R266	24011102	CHIP, METAL FILM, 1/20W 1K OHM J
R271	24366471	CARBON FILM, 1/6W 470 OHM J
R272	24366222	CARBON FILM, 1/6W 2.2K OHM J
R301	24011272	CHIP, 1/20W 2.7K OHM J
R303	24321109	OXIDE METAL FILM, 1/2W 1 OHM J
R304	24366623	CARBON FILM, 1/6W 62K OHM J
R305	24322828	OXIDE METAL FILM, 1W 0.82 OHM J
R306	24366104	CARBON FILM, 1/6W 100K OHM J
R307	24366684	CARBON FILM, 1/6W 680K OHM J
R308	24382821	OXIDE METAL FILM, 1W 82 OHM J
R312	24366153	CARBON FILM, 1/6W 15K OHM J
R313	24011104	CHIP, METAL FILM, 1/20W 100K OHM J
R314	24366104	CARBON FILM, 1/6W 100K OHM J
R315	24011104	CHIP, METAL FILM, 1/20W 100K OHM J
R316	24366154	CARBON FILM, 1/6W 150K OHM J
R317	24011102	CHIP, METAL FILM, 1/20W 1K OHM J
R318	24011473	CHIP, METAL FILM, 1/20W 47K OHM J
△R327	24339479	OXIDE METAL FILM, 2W 4.7 OHM J
R328	24366684	CARBON FILM, 1/6W 680K OHM J
R336	24383151	OXIDE METAL FILM, 2W 150 OHM J
R360	24011104	CHIP, METAL FILM, 1/20W 100K OHM J
R361	24011473	CHIP, METAL FILM, 1/20W 47K OHM J
△R370	24321109	OXIDE METAL FILM, 1/2W 1 OHM J
R371	24011103	CHIP, METAL FILM, 1/20W 10K OHM J
R372	24011392	CHIP, 1/20W 3.9K OHM J
R373	24011102	CHIP, METAL FILM, 1/20W 1K OHM J
R374	24366183	CARBON FILM, 1/6W 18K OHM J
R401	24011391	CHIP, 1/20W 390 OHM J
R402	24382682	OXIDE METAL FILM, 1W 6.8K OHM J
R403	24011622	CHIP, METAL FILM, 1/20W 6.2K OHM J
R405	24382682	OXIDE METAL FILM, 1W 6.8K OHM J
R406	24366273	CARBON FILM, 1/6W 27K OHM J
R407	24011103	CHIP, METAL FILM, 1/20W 10K OHM J
R408	24011472	CHIP, METAL FILM, 1/20W 4.7K OHM J
R410	24011271	CHIP, 1/20W 270 OHM J
R411	24366561	CARBON FILM, 1/6W 560 OHM J
R415	24553272	OXIDE METAL FILM, 1W 2.7K OHM J
R416	24510332	CERAMIC COVERED, 5W 3.3K OHM J
R418	24383181	OXIDE METAL FILM, 2W 180 OHM J
R429	24366104	CARBON FILM, 1/6W 100K OHM J
R430	24366102	CARBON FILM, 1/6W 1K OHM J
R431	24011103	CHIP, METAL FILM, 1/20W 10K OHM J
R432	24366202	CARBON FILM, 1/6W 2K OHM J
R441	24532102	FUSIBLE, 1W 1K OHM J
R443	24382153	OXIDE METAL FILM, 1W 15K OHM J
R450	24011103	CHIP, METAL FILM, 1/20W 10K OHM J
R455	24011103	CHIP, METAL FILM, 1/20W 10K OHM J
R457	24011473	CHIP, METAL FILM, 1/20W 47K OHM J
R458	24011104	CHIP, METAL FILM, 1/20W 100K OHM J
R460	24366562	CARBON FILM, 1/6W 5.6K OHM J
R461	24366182	CARBON FILM, 1/6W 1.8K OHM J
R463	24322399	OXIDE METAL FILM, 1W 3.9 OHM J

Location No.	Parts No.	Description
R464	24366103	CARBON FILM, 1/6W 10K OHM J
R466	24366103	CARBON FILM, 1/6W 10K OHM J
R472	24381270	OXIDE METAL FILM, 1/2W 27 OHM J
△ R475	24011391	CHIP, 1/20W 390 OHM J
R476	24366823	CARBON FILM, 1/6W 82K OHM J
R477	24011273	CHIP, 1/20W 27K OHM J
△ R478	24327133	METAL FILM, 1/4W 13K OHM F
R480	24011123	CHIP, METAL FILM, 1/20W 12K OHM J
R481	24011333	CHIP, METAL FILM, 1/20W 33K OHM J
△ R482	24327472	METAL FILM 1/4W 4R7K F
R483	24366103	CARBON FILM, 1/6W 10K OHM J
△ R485	24338478	OXIDE METAL FILM, 1W 0.47 OHM J
R486	24552820	OXIDE METAL FILM, 1/2W 82 OHM J
R487	24552301	OXIDE METAL FILM, 1/2W 300 OHM J
R488	24327183	RESISTOR, METAL FILM, 1/4W 18K OHM F
R489	24327183	RESISTOR, METAL FILM, 1/4W 18K OHM F
R490	24011102	CHIP, METAL FILM, 1/20W 1K OHM J
R493	24011102	CHIP, METAL FILM, 1/20W 1K OHM J
R494	24011471	CHIP, METAL FILM, 1/20W 470 OHM J
R495	24366561	CARBON FILM, 1/6W 560 OHM J
R501	24011153	CHIP, METAL FILM, 1/20W 15K OHM J
R502	24011101	CHIP, METAL FILM, 1/20W 100 OHM J
R503	24011101	CHIP, METAL FILM, 1/20W 100 OHM J
R511	24366391	CARBON FILM, 1/6W 390 OHM J
R512	24011391	CHIP, 1/20W 390 OHM J
R614	24011102	CHIP, METAL FILM, 1/20W 1K OHM J
R615	24011222	CHIP, METAL FILM, 1/20W 2.2K OHM J
R616	24011103	CHIP, METAL FILM, 1/20W 10K OHM J
R661	24011472	CHIP, METAL FILM, 1/20W 4.7K OHM J
R662	24011472	CHIP, METAL FILM, 1/20W 4.7K OHM J
R663	24011152	CHIP, METAL FILM, 1/20W 1.5K OHM J
R664	24011152	CHIP, METAL FILM, 1/20W 1.5K OHM J
R667	24011223	CHIP, METAL FILM, 1/20W 22K OHM J
R668	24366103	CARBON FILM, 1/6W 10K OHM J
R669	24011103	CHIP, METAL FILM, 1/20W 10K OHM J
R676	24366229	CARBON FILM, 1/6W 2.2 OHM J
R677	24366229	CARBON FILM, 1/6W 2.2 OHM J
R679	24000824	CHIP JUMPER, 2125TYPE
R702	24366681	CARBON FILM, 1/6W 680 OHM J
R709	24366563	CARBON FILM, 1/6W 56K OHM J
R713	24366393	CARBON FILM, 1/6W 39K OHM J
R714	24552121	OXIDE METAL FILM, 1/2W 120 OHM J
R715	24366273	CARBON FILM, 1/6W 27K OHM J
R716	24366333	CARBON FILM, 1/6W 33K OHM J
R717	24366333	CARBON FILM, 1/6W 33K OHM J
R718	24366101	CARBON FILM, 1/6W 100 OHM J
R719	24366392	CARBON FILM, 1/6W 3.9K OHM J
R720	24366392	CARBON FILM, 1/6W 3.9K OHM J
R722	24366102	CARBON FILM, 1/6W 1K OHM J
R723	24366471	CARBON FILM, 1/6W 470 OHM J
R724	24366820	CARBON FILM, 1/6W 82 OHM J
R725	24366182	CARBON FILM, 1/6W 1.8K OHM J
R730	24552100	OXIDE METAL FILM, 1/2W 10 OHM J
R731	24552331	OXIDE METAL FILM, 1/2W 330 OHM J
R732	24366820	CARBON FILM, 1/6W 82 OHM J
R733	24366683	CARBON FILM, 1/6W 68K OHM J
R734	24366820	CARBON FILM, 1/6W 82 OHM J
R735	24366683	CARBON FILM, 1/6W 68K OHM J
R736	24366620	CARBON FILM, 1/6W 62 OHM J
R737	24366152	CARBON FILM, 1/6W 1.5K OHM J
R738	24366102	CARBON FILM, 1/6W 1K OHM J
R739	24366152	CARBON FILM, 1/6W 1.5K OHM J
R740	24366620	CARBON FILM, 1/6W 62 OHM J
R741	24366279	CARBON FILM, 1/6W 2.7 OHM J
R742	24366279	CARBON FILM, 1/6W 2.7 OHM J
R743	24554221	OXIDE METAL FILM, 2W 220 OHM J

Location No.	Parts No.	Description
R744	24366122	CARBON FILM, 1/6W 1.2K OHM J
R745	24366122	CARBON FILM, 1/6W 1.2K OHM J
R803	24004943	METAL FILM, 1W 0.12 OHM J
△ R808	24019493	THERMISTOR, PTC, AC140V 1.5 OHM M
△ R810	24569828	CERAMIC COVERED G 10W 0.82 K
R814	24366122	CARBON FILM, 1/6W 1.2K OHM J
R815	24552332	OXIDE METAL FILM, 1/2W 3.3K OHM J
R818	24510150	CERAMIC COVERED, 5W 15 OHM J
R820	24004942	METAL FILM, 1W 0.1 OHM J
R821	24321479	OXIDE METAL FILM, 1/2W 4.7 OHM J
R823	24011122	CHIP, METAL FILM, 1/20W 1.2K OHM J
R829	24004942	METAL FILM, 1W 0.1 OHM J
R835	24552471	OXIDE METAL FILM, 1/2W 470 OHM J
R861	24553223	OXIDE METAL FILM, 1W 22K OHM J
R883	24552471	OXIDE METAL FILM, 1/2W 470 OHM J
R884	24366471	CARBON FILM, 1/6W 470 OHM J
R885	24366102	CARBON FILM, 1/6W 1K OHM J
R891	24366102	CARBON FILM, 1/6W 1K OHM J
△ R898	24010001	CARBON FILM, 1/2W 3.9M OHM J
R901	24376561	CARBON FILM, 1/2W 560 OHM J
R902	24376561	CARBON FILM, 1/2W 560 OHM J
R903	24376561	CARBON FILM, 1/2W 560 OHM J
R904	24366103	CARBON FILM, 1/6W 10K OHM J
R905	24366101	CARBON FILM, 1/6W 100 OHM J
R912	24366102	CARBON FILM, 1/6W 1K OHM J
R914	24366561	CARBON FILM, 1/6W 560 OHM J
R915	24366101	CARBON FILM, 1/6W 100 OHM J
R916	24366680	CARBON FILM, 1/6W 68 OHM J
R917	24366471	CARBON FILM, 1/6W 470 OHM J
R918	24366820	CARBON FILM, 1/6W 82 OHM J
R919	24366102	CARBON FILM, 1/6W 1K OHM J
△ R920	24000189	FUSIBLE, 1W 4.7 OHM J
R921	24366561	CARBON FILM, 1/6W 560 OHM J
R922	24366101	CARBON FILM, 1/6W 100 OHM J
R923	24366391	CARBON FILM, 1/6W 390 OHM J
R924	24366820	CARBON FILM, 1/6W 82 OHM J
R925	24366471	CARBON FILM, 1/6W 470 OHM J
R926	24366102	CARBON FILM, 1/6W 1K OHM J
R928	24366561	CARBON FILM, 1/6W 560 OHM J
R929	24366101	CARBON FILM, 1/6W 100 OHM J
R930	24366820	CARBON FILM, 1/6W 82 OHM J
R932	24366272	CARBON FILM, 1/6W 2.7K OHM J
R933	24366750	CARBON FILM, 1/6W 75 OHM J
R934	24366391	CARBON FILM, 1/6W 390 OHM J
R935	24366821	CARBON FILM, 1/6W 820 OHM J
R936	24366750	CARBON FILM, 1/6W 75 OHM J
R937	24366471	CARBON FILM, 1/6W 470 OHM J
R939	24366680	CARBON FILM, 1/6W 68 OHM J
R940	24366821	CARBON FILM, 1/6W 820 OHM J
R942	24366392	CARBON FILM, 1/6W 3.9K OHM J
R943	24366392	CARBON FILM, 1/6W 3.9K OHM J
R944	24366392	CARBON FILM, 1/6W 3.9K OHM J
R945	24366680	CARBON FILM, 1/6W 68 OHM J
R946	24366680	CARBON FILM, 1/6W 68 OHM J
R947	24366103	CARBON FILM, 1/6W 10K OHM J
R948	24366103	CARBON FILM, 1/6W 10K OHM J
R949	24366103	CARBON FILM, 1/6W 10K OHM J
R950	24366302	CARBON FILM, 1/6W 3K OHM J
R951	24366682	CARBON FILM, 1/6W 6.8K OHM J
R952	24366101	CARBON FILM, 1/6W 100 OHM J
R955	24366122	CARBON FILM, 1/6W 1.2K OHM J
R957	24366822	CARBON FILM, 1/6W 8.2K OHM J
R960	24383153	OXIDE METAL FILM, 2W 15K OHM J
R961	24383153	OXIDE METAL FILM, 2W 15K OHM J
R962	24383153	OXIDE METAL FILM, 2W 15K OHM J
R963	24383153	OXIDE METAL FILM, 2W 15K OHM J

Location No.	Parts No.	Description
R964	24383153	OXIDE METAL FILM, 2W 15K OHM J
R965	24383153	OXIDE METAL FILM, 2W 15K OHM J
R973	24366472	CARBON FILM, 1/6W 4.7K OHM J
R976	24366561	CARBON FILM, 1/6W 560 OHM J
R977	24366122	CARBON FILM, 1/6W 1.2K OHM J
R978	24366561	CARBON FILM, 1/6W 560 OHM J
R979	24366561	CARBON FILM, 1/6W 560 OHM J
R980	24366471	CARBON FILM, 1/6W 470 OHM J
R981	24366821	CARBON FILM, 1/6W 820 OHM J
R982	24366103	CARBON FILM, 1/6W 10K OHM J
R983	24366222	CARBON FILM, 1/6W 2.2K OHM J
R984	24367152	CARBON FILM, 1/6W 1.5K OHM G
R985	24367471	CARBON FILM, 1/6W 470 OHM G
R986	24367681	CARBON FILM, 1/6W 680 OHM G
R987	24367681	CARBON FILM, 1/6W 680 OHM G
R988	24367472	CARBON FILM, 1/6W 4.7K OHM G
R989	24367332	CARBON FILM, 1/6W 3.3K OHM G
R990	24366222	CARBON FILM, 1/6W 2.2K OHM J
R991	24367681	CARBON FILM, 1/6W 680 OHM G
R992	24366150	CARBON FILM, 1/6W 15 OHM J
R993	24366471	CARBON FILM, 1/6W 470 OHM J
R994	24366392	CARBON FILM, 1/6W 3.9K OHM J
R997	24366272	CARBON FILM, 1/6W 2.7K OHM J
R998	24366472	CARBON FILM, 1/6W 4.7K OHM J
R999	24366472	CARBON FILM, 1/6W 4.7K OHM J
R2701	24011105	CHIP, METAL FILM, 1/20W 1M OHM J
R2702	24011102	CHIP, METAL FILM, 1/20W 1K OHM J
R2703	24011332	CHIP, METAL FILM, 1/20W 3.3K OHM J
R2705	24011102	CHIP, METAL FILM, 1/20W 1K OHM J
R2706	24011102	CHIP, METAL FILM, 1/20W 1K OHM J
R2707	24011221	CHIP, METAL FILM, 1/20W 220 OHM J
R2708	24011331	CHIP, METAL FILM, 1/20W 330 OHM J
R2709	24011331	CHIP, METAL FILM, 1/20W 330 OHM J
R2710	24011101	CHIP, METAL FILM, 1/20W 100 OHM J
R2711	24011332	CHIP, METAL FILM, 1/20W 3.3K OHM J
R2712	24366472	CARBON FILM, 1/6W 4.7K OHM J
R4460	24011102	CHIP, METAL FILM, 1/20W 1K OHM J
R4461	24011102	CHIP, METAL FILM, 1/20W 1K OHM J
R4462	24011133	CHIP, METAL FILM, 1/20W 13K OHM J
R4463	24011682	CHIP, METAL FILM, 1/20W 6.8K OHM J
R4465	24011223	CHIP, METAL FILM, 1/20W 22K OHM J
R4466	24011223	CHIP, METAL FILM, 1/20W 22K OHM J
R4467	24011223	CHIP, METAL FILM, 1/20W 22K OHM J
R4468	24011472	CHIP, METAL FILM, 1/20W 4.7K OHM J
R4761	24366102	CARBON FILM, 1/6W 1K OHM J
R4764	24000445	CHIP JUMPER, 1608TYPE
R4765	24366221	CARBON FILM, 1/6W 220 OHM J
RA03	24011102	CHIP, METAL FILM, 1/20W 1K OHM J
RA04	24011102	CHIP, METAL FILM, 1/20W 1K OHM J
RA07	24011102	CHIP, METAL FILM, 1/20W 1K OHM J
RA08	24011102	CHIP, METAL FILM, 1/20W 1K OHM J
RA09	24011102	CHIP, METAL FILM, 1/20W 1K OHM J
RA13	24011103	CHIP, METAL FILM, 1/20W 10K OHM J
RA15	24011102	CHIP, METAL FILM, 1/20W 1K OHM J
RA16	24011102	CHIP, METAL FILM, 1/20W 1K OHM J
RA17	24011102	CHIP, METAL FILM, 1/20W 1K OHM J
RA18	24011102	CHIP, METAL FILM, 1/20W 1K OHM J
RA20	24011221	CHIP, METAL FILM, 1/20W 220 OHM J
RA21	24011102	CHIP, METAL FILM, 1/20W 1K OHM J
RA22	24011331	CHIP, METAL FILM, 1/20W 330 OHM J
RA23	24011331	CHIP, METAL FILM, 1/20W 330 OHM J
RA24	24011331	CHIP, METAL FILM, 1/20W 330 OHM J
RA25	24011331	CHIP, METAL FILM, 1/20W 330 OHM J
RA26	24011102	CHIP, METAL FILM, 1/20W 1K OHM J
RA27	24011102	CHIP, METAL FILM, 1/20W 1K OHM J
RA33	24011103	CHIP, METAL FILM, 1/20W 10K OHM J

Location No.	Parts No.	Description
RA35	24011102	CHIP, METAL FILM, 1/20W 1K OHM J
RA36	24011103	CHIP, METAL FILM, 1/20W 10K OHM J
RA37	24011331	CHIP, METAL FILM, 1/20W 330 OHM J
RA38	24011331	CHIP, METAL FILM, 1/20W 330 OHM J
RA40	24011101	CHIP, METAL FILM, 1/20W 100 OHM J
RA41	24011101	CHIP, METAL FILM, 1/20W 100 OHM J
RA61	24011103	CHIP, METAL FILM, 1/20W 10K OHM J
RA62	24011103	CHIP, METAL FILM, 1/20W 10K OHM J
RA67	24011472	CHIP, METAL FILM, 1/20W 4.7K OHM J
RA68	24011472	CHIP, METAL FILM, 1/20W 4.7K OHM J
RA71	24366683	CARBON FILM, 1/6W 68K OHM J
RA72	24366223	CARBON FILM, 1/6W 22K OHM J
RA73	24366103	CARBON FILM, 1/6W 10K OHM J
RA74	24011333	CHIP, METAL FILM, 1/20W 33K OHM J
RA201	24011472	CHIP, METAL FILM, 1/20W 4.7K OHM J
RB03	24366101	CARBON FILM, 1/6W 100 OHM J
RB11	24366271	CARBON FILM, 1/6W 270 OHM J
RB12	24366103	CARBON FILM, 1/6W 10K OHM J
RB13	24366470	CARBON FILM, 1/6W 47 OHM J
RB24	24011223	CHIP, METAL FILM, 1/20W 22K OHM J
RB25	24011472	CHIP, METAL FILM, 1/20W 4.7K OHM J
RB30	24011103	CHIP, METAL FILM, 1/20W 10K OHM J
RB43	24011103	CHIP, METAL FILM, 1/20W 10K OHM J
RB44	24011103	CHIP, METAL FILM, 1/20W 10K OHM J
RB45	24011181	CHIP, METAL FILM, 1/20W 180 OHM J
RB46	24011101	CHIP, METAL FILM, 1/20W 100 OHM J
RB47	24011332	CHIP, METAL FILM, 1/20W 3.3K OHM J
RB49	24011332	CHIP, METAL FILM, 1/20W 3.3K OHM J
RB60	24011101	CHIP, METAL FILM, 1/20W 100 OHM J
RB61	24011224	CHIP, METAL FILM, 1/20W 220K OHM J
RB62	24011123	CHIP, METAL FILM, 1/20W 12K OHM J
RB63	24011392	CHIP, 1/20W 3.9K OHM J
RB64	24011103	CHIP, METAL FILM, 1/20W 10K OHM J
RB65	24011221	CHIP, METAL FILM, 1/20W 220 OHM J
RB66	24011103	CHIP, METAL FILM, 1/20W 10K OHM J
RB67	24011102	CHIP, METAL FILM, 1/20W 1K OHM J
RD41	24011104	CHIP, METAL FILM, 1/20W 100K OHM J
RD42	24011101	CHIP, METAL FILM, 1/20W 100 OHM J
RD43	24366101	CARBON FILM, 1/6W 100 OHM J
RD45	24366221	CARBON FILM, 1/6W 220 OHM J
RD48	24011101	CHIP, METAL FILM, 1/20W 100 OHM J
RD49	24011104	CHIP, METAL FILM, 1/20W 100K OHM J
RD79	24011105	CHIP, METAL FILM, 1/20W 1M OHM J
RD80	24011472	CHIP, METAL FILM, 1/20W 4.7K OHM J
RD81	24011105	CHIP, METAL FILM, 1/20W 1M OHM J
RD82	24011472	CHIP, METAL FILM, 1/20W 4.7K OHM J
RD83	24011103	CHIP, METAL FILM, 1/20W 10K OHM J
RD85	24011223	CHIP, METAL FILM, 1/20W 22K OHM J
RD86	24011223	CHIP, METAL FILM, 1/20W 22K OHM J
RD87	24011512	CHIP, METAL FILM, 1/20W 5.1K OHM J
RD88	24011512	CHIP, METAL FILM, 1/20W 5.1K OHM J
RG01	24011101	CHIP, METAL FILM, 1/20W 100 OHM J
RG04	24011105	CHIP, METAL FILM, 1/20W 1M OHM J
RG05	24011222	CHIP, METAL FILM, 1/20W 2.2K OHM J
RG06	24011182	CHIP, METAL FILM, 1/20W 1.8K OHM J
RG07	24011623	CHIP, 1/20W 62K OHM J
RG08	24011332	CHIP, METAL FILM, 1/20W 3.3K OHM J
RG09	24011302	CHIP, METAL FILM, 1/20W 3K OHM J
RG10	24011392	CHIP, 1/20W 3.9K OHM J
RG15	24011221	CHIP, METAL FILM, 1/20W 220 OHM J
RG19	24011105	CHIP, METAL FILM, 1/20W 1M OHM J
RG20	24011105	CHIP, METAL FILM, 1/20W 1M OHM J
RG21	24011105	CHIP, METAL FILM, 1/20W 1M OHM J
RG22	24011105	CHIP, METAL FILM, 1/20W 1M OHM J
RG23	24011105	CHIP, METAL FILM, 1/20W 1M OHM J
RG24	24011105	CHIP, METAL FILM, 1/20W 1M OHM J

Location No.	Parts No.	Description
RG25	24011101	CHIP, METAL FILM, 1/20W 100 OHM J
RG26	24011104	CHIP, METAL FILM, 1/20W 100K OHM J
RG27	24011101	CHIP, METAL FILM, 1/20W 100 OHM J
RI01	24011270	CHIP, 1/20W 27 OHM J
RI02	24011512	CHIP, METAL FILM, 1/20W 5.1K OHM J
RI03	24011102	CHIP, METAL FILM, 1/20W 1K OHM J
RI04	24011470	CHIP, METAL FILM, 1/20W 47 OHM J
RI05	24011361	CHIP, 1/20W 360 OHM J
RI06	24011519	METAL FILM CHIP 1/16W 5.1 J
RI07	24011360	METAL FILM CHIP 1/20W 36 J
RI08	24011332	CHIP, METAL FILM, 1/20W 3.3K OHM J
RI09	24011123	CHIP, METAL FILM, 1/20W 12K OHM J
RI11	24011113	CHIP, METAL FILM, 1/20W 11K OHM J
RI13	24011112	CHIP, 1/20W 1.1K OHM J
RI14	24011102	CHIP, METAL FILM, 1/20W 1K OHM J
RI15	24011182	CHIP, METAL FILM, 1/20W 1.8K OHM J
RI16	24011122	CHIP, METAL FILM, 1/20W 1.2K OHM J
RI17	24011101	CHIP, METAL FILM, 1/20W 100 OHM J
RI18	24011132	CHIP, METAL FILM, 1/20W 1.3K OHM J
RI19	24011391	CHIP, 1/20W 390 OHM J
RI20	24011821	CHIP, 1/20W 820 OHM J
RI21	24011271	CHIP, 1/20W 270 OHM J
RI22	24011475	METAL FILM CHIP 1/16W 4R7M K
RI23	24011221	CHIP, METAL FILM, 1/20W 220 OHM J
RI27	24011103	CHIP, METAL FILM, 1/20W 10K OHM J
RI28	24011123	CHIP, METAL FILM, 1/20W 12K OHM J
RI30	24011102	CHIP, METAL FILM, 1/20W 1K OHM J
RI32	24366750	CARBON FILM, 1/6W 75 OHM J
RI33	24011124	CHIP, 1/20W 120K OHM J
RI35	24011563	CHIP, METAL FILM, 1/20W 56K OHM J
RI36	24011683	CHIP, METAL FILM, 1/20W 68K OHM J
RI51	24066046	VARIABLE. CARBON, RV06T 0.1W 20K N
RI52	24011101	CHIP, METAL FILM, 1/20W 100 OHM J
RJ30 #2	24000445	CHIP JUMPER, 1608TYPE
RJ41	24000445	CHIP JUMPER, 1608TYPE
RJ42	24000445	CHIP JUMPER, 1608TYPE
RJ43	24000445	CHIP JUMPER, 1608TYPE
RJ44	24000445	CHIP JUMPER, 1608TYPE
RJ45	24000445	CHIP JUMPER, 1608TYPE
RJ46	24000445	CHIP JUMPER, 1608TYPE
RJ47	24000445	CHIP JUMPER, 1608TYPE
RR07	24011681	CHIP, METAL FILM, 1/20W 680 OHM J
RR93	24011472	CHIP, METAL FILM, 1/20W 4.7K OHM J
RS02	24011562	CHIP, METAL FILM, 1/20W 5.6K OHM J
RS04	24011562	CHIP, METAL FILM, 1/20W 5.6K OHM J
RS08	24011562	CHIP, METAL FILM, 1/20W 5.6K OHM J
RS10	24011562	CHIP, METAL FILM, 1/20W 5.6K OHM J
RS14	24011562	CHIP, METAL FILM, 1/20W 5.6K OHM J
RS16	24011562	CHIP, METAL FILM, 1/20W 5.6K OHM J
RS25	24011562	CHIP, METAL FILM, 1/20W 5.6K OHM J
RS26	24011562	CHIP, METAL FILM, 1/20W 5.6K OHM J
RS40	24011272	CHIP, 1/20W 2.7K OHM J
RS41	24011750	CHIP, METAL FILM, 1/20W 75 OHM J
RS42	24011272	CHIP, 1/20W 2.7K OHM J
RS43	24011103	CHIP, METAL FILM, 1/20W 10K OHM J
RS44	24011103	CHIP, METAL FILM, 1/20W 10K OHM J
RS60	24011101	CHIP, METAL FILM, 1/20W 100 OHM J
RS61	24011222	CHIP, METAL FILM, 1/20W 2.2K OHM J
RS62	24366101	CARBON FILM, 1/6W 100 OHM J
RS63	24011222	CHIP, METAL FILM, 1/20W 2.2K OHM J
RS64	24011102	CHIP, METAL FILM, 1/20W 1K OHM J
RS65	24011102	CHIP, METAL FILM, 1/20W 1K OHM J
RS66	24011102	CHIP, METAL FILM, 1/20W 1K OHM J
RS68	24011223	CHIP, METAL FILM, 1/20W 22K OHM J
RS69	24011223	CHIP, METAL FILM, 1/20W 22K OHM J
RS70	24011104	CHIP, METAL FILM, 1/20W 100K OHM J

Location No.	Parts No.	Description
RS71	24011104	CHIP, METAL FILM, 1/20W 100K OHM J
RS101	24011123	CHIP, METAL FILM, 1/20W 12K OHM J
RS102	24011123	CHIP, METAL FILM, 1/20W 12K OHM J
RS105	24011222	CHIP, METAL FILM, 1/20W 2.2K OHM J
RS107	24011473	CHIP, METAL FILM, 1/20W 47K OHM J
RS108	24011473	CHIP, METAL FILM, 1/20W 47K OHM J
RS109	24011433	CHIP, METAL FILM, 1/20W 43K OHM J
RS113	24011433	CHIP, METAL FILM, 1/20W 43K OHM J
RS611	24366101	CARBON FILM, 1/6W 100 OHM J
RS612	24011101	CHIP, METAL FILM, 1/20W 100 OHM J
RV02	24011750	CHIP, METAL FILM, 1/20W 75 OHM J
RV04	24011750	CHIP, METAL FILM, 1/20W 75 OHM J
RV05	24011750	CHIP, METAL FILM, 1/20W 75 OHM J
RV07	24011103	CHIP, METAL FILM, 1/20W 10K OHM J
RV12	24011103	CHIP, METAL FILM, 1/20W 10K OHM J
RV14	24011102	CHIP, METAL FILM, 1/20W 1K OHM J
RV15	24011102	CHIP, METAL FILM, 1/20W 1K OHM J
RV16	24011471	CHIP, METAL FILM, 1/20W 470 OHM J
RV17	24011101	CHIP, METAL FILM, 1/20W 100 OHM J
RV19	24366750	CARBON FILM, 1/6W 75 OHM J
RV20	24011101	CHIP, METAL FILM, 1/20W 100 OHM J
RV21	24011103	CHIP, METAL FILM, 1/20W 10K OHM J
RV22	24011103	CHIP, METAL FILM, 1/20W 10K OHM J
RV23	24011102	CHIP, METAL FILM, 1/20W 1K OHM J
RV24	24011102	CHIP, METAL FILM, 1/20W 1K OHM J
RV61	24366101	CARBON FILM, 1/6W 100 OHM J
RV62	24011750	CHIP, METAL FILM, 1/20W 75 OHM J
RV63	24011101	CHIP, METAL FILM, 1/20W 100 OHM J
RV120	24366750	CARBON FILM, 1/6W 75 OHM J
RV606	24011103	CHIP, METAL FILM, 1/20W 10K OHM J
RW01	24011750	CHIP, METAL FILM, 1/20W 75 OHM J
RW02	24011750	CHIP, METAL FILM, 1/20W 75 OHM J
RW03	24011750	CHIP, METAL FILM, 1/20W 75 OHM J
RZ06 #1	24011821	CHIP, 1/20W 820 OHM J
RZ07	24366331	CARBON FILM, 1/6W 330 OHM J
RZ08	24011151	CHIP, METAL FILM, 1/20W 150 OHM J
RZ09	24011271	CHIP, 1/20W 270 OHM J
RZ10	24011102	CHIP, METAL FILM, 1/20W 1K OHM J
RZ11	24011102	CHIP, METAL FILM, 1/20W 1K OHM J
RZ12	24011182	CHIP, METAL FILM, 1/20W 1.8K OHM J
RZ13	24011392	CHIP, 1/20W 3.9K OHM J
RZ14	24011123	CHIP, METAL FILM, 1/20W 12K OHM J
RZ15	24011151	CHIP, METAL FILM, 1/20W 150 OHM J
RZ16	24366182	CARBON FILM, 1/6W 1.8K OHM J
RZ17	24366181	CARBON FILM, 1/6W 180 OHM J
RZ18	24011121	CHIP, METAL FILM, 1/20W 120 OHM J
RZ20	24011152	CHIP, METAL FILM, 1/20W 1.5K OHM J
RZ21	24011471	CHIP, METAL FILM, 1/20W 470 OHM J
RZ22	24011101	CHIP, METAL FILM, 1/20W 100 OHM J
RZ28	24011102	CHIP, METAL FILM, 1/20W 1K OHM J
RZ29 #1	24366331	CARBON FILM, 1/6W 330 OHM J
RZ30 #1	24366331	CARBON FILM, 1/6W 330 OHM J
RZ31	24011682	CHIP, METAL FILM, 1/20W 6.8K OHM J
RZ40	24011562	CHIP, METAL FILM, 1/20W 5.6K OHM J
RZ43	24011220	CHIP, METAL FILM, 1/20W 22 OHM J
RZ44	24011152	CHIP, METAL FILM, 1/20W 1.5K OHM J
RZ45	24011220	CHIP, METAL FILM, 1/20W 22 OHM J
RZ46	24011152	CHIP, METAL FILM, 1/20W 1.5K OHM J
RZ49	24011102	CHIP, METAL FILM, 1/20W 1K OHM J
RZ50	24011102	CHIP, METAL FILM, 1/20W 1K OHM J
RZ60	24011102	CHIP, METAL FILM, 1/20W 1K OHM J
RZ61	24011681	CHIP, METAL FILM, 1/20W 680 OHM J
RZ70	24011392	CHIP, 1/20W 3.9K OHM J
RZ71	24011103	CHIP, METAL FILM, 1/20W 10K OHM J
RZ330 #2	24011101	CHIP, METAL FILM, 1/20W 100 OHM J
RZ340 #2	24011101	CHIP, METAL FILM, 1/20W 100 OHM J

Location No.	Parts No.	Description
RZ370 #2	24000445	CHIP JUMPER, 1608TYPE
RZ380 #2	24011103	CHIP, METAL FILM, 1/20W 10K OHM J
RZ400 #2	24000445	CHIP JUMPER, 1608TYPE
RZ410 #2	24011562	CHIP, METAL FILM, 1/20W 5.6K OHM J
RZ420 #2	24011472	CHIP, METAL FILM, 1/20W 4.7K OHM J
RZ430 #2	24000445	CHIP JUMPER, 1608TYPE
RZ800 #2	24000445	CHIP JUMPER, 1608TYPE
RZ810 #2	24000445	CHIP JUMPER, 1608TYPE
RZ820 #2	24011101	CHIP, METAL FILM, 1/20W 100 OHM J
RZ830 #2	24011102	CHIP, METAL FILM, 1/20W 1K OHM J
COIL & TRANSFORMERS		
L101	23289846	COIL, PEAKING, TRF4101AT
L201	23238703	COIL, PEAKING, TRF4820AJ
L301	23103145	FERRITE CHOKE, TEM2011AA
L401	23280016	COIL, PEAKING, TRF4100AZ
△L441	23233103	COIL, LINIALITY, TLN2083AH
L442	23248121	COIL, CHOKE, TLN3383D
△L461	23248173	COIL, CHOKE, TLN3333AD
#1	23248172	COIL, CHOKE TLN3332AD
L501	23238711	COIL, PEAKING, TRF4180AJ
L502	23289844	COIL, PEAKING, TRF4470AT
L599	23103145	FERRITE CHOKE, TEM2011AA
L702	23261974	COIL, FERRITE BEAD, HC5-035
L704	23103145	FERRITE CHOKE, TEM2011AA
L705	23103145	FERRITE CHOKE, TEM2011AA
L805	23248213	COIL, CHOKE, TLN3481AH
L806	23248213	COIL, CHOKE, TLN3481AH
L815	23103145	FERRITE CHOKE, TEM2011AA
L816	23103145	FERRITE CHOKE, TEM2011AA
L883	23103145	FERRITE CHOKE, TEM2011AA
L886	23103145	FERRITE CHOKE, TEM2011AA
L887	23248073	COIL, CHOKE, TLN3299D
L888	23280016	COIL, PEAKING, TRF4100AZ
L889	23280016	COIL, PEAKING, TRF4100AZ
L890	23103145	FERRITE CHOKE, TEM2011AA
L893	23280016	COIL, PEAKING, TRF4100AZ
△L901	23200559	COIL, DG 0.65CU 42T-2LOOP TSB-2412AH
L902	23289101	COIL, PEAKING, TRF4101AF
L903	23289101	COIL, PEAKING, TRF4101AF
L904	23289101	COIL, PEAKING, TRF4101AF
L905	23289390	COIL, PEAKING, TRF4390AF
L906	23289390	COIL, PEAKING, TRF4390AF
L907	23289390	COIL, PEAKING, TRF4390AF
L908	23289100	COIL, PEAKING, TRF4100AF
L910	23237991	COIL, PEAKING, TRF4479AC
L2704	23103145	FERRITE CHOKE, TEM2011AA
L2705	23103906	FILTER, CHIP BEAD INDUCTOR, TEM2118AS
L2711	23289840	COIL, PEAKING, TRF4100AT
LA01	23289840	COIL, PEAKING, TRF4100AT
LB01	23262302	COIL, IF COIL 11.8MHZ 5SVL TRF1247AH
LI01	23246051	COIL, CHIP-INDUCTOR-0.22MMH K COLTRF4R22CE
LI02	23246196	COIL, CHIP INDUCTOR, TRF41R2CG
LI51	23289926	COIL, PEAKING, TRF4470AU
LI52	23289919	COIL, PEAKING, TRF4120AU
LI53	23289921	COIL, PEAKING, TRF4180AU
LI54	23232050	COIL, VARIABLE TRF3554D
LI55	23289907	COIL, PEAKING, TRF4129AU
LI56	23289921	COIL, PEAKING, TRF4180AU
LI57	23238554	COIL, PEAKING, TRF4R22AJ
LV01	23289840	COIL, PEAKING, TRF4100AT
LV02	23103852	COIL, FILTER, TEM2028AH
LV98	23103159	FILTER, EMI, TEM2028AA, 7.5X6.4X8 60MMH 0.5A
LV99	23103159	FILTER, EMI, TEM2028AA, 7.5X6.4X8 60MMH 0.5A
LZ01	23289840	COIL, PEAKING, TRF4100AT
LZ02 #1	23103880	COIL, CHOKE, TEM2011Y

Location No.	Parts No.	Description
LZ04 #1	23103880	COIL, CHOKE, TEM2011Y
LZ05 #1	23238714	COIL, PEAKING, TRF4100AJ
LZ06 #1	23103906	FILTER, CHIP BEAD INDUCTOR, TEM2118AS
LZ07 #1	24000445	CHIP JUMPER, 1608TYPE
LZ08 #1	23238707	COIL, PEAKING, TRF4390AJ
LZ09 #1	23289840	COIL, PEAKING, TRF4100AT
LZ20	23238718	COIL, PEAKING, TRF4479AJ
LZ21	23238714	COIL, PEAKING, TRF4100AJ
LZ22	23238506	COIL, PEAKING, TRF4229AJ
LZ96	23238715	COIL, PEAKING, TRF4829AJ
LZ230 #2	23103906	FILTER, CHIP BEAD INDUCTOR, TEM2118AS
LZ240 #2	23103906	FILTER, CHIP BEAD INDUCTOR, TEM2118AS
LZ250 #2	23103906	FILTER, CHIP BEAD INDUCTOR, TEM2118AS
LZ260 #2	23103145	FERRITE CHOKE, TEM2011AA
LZ280 #2	23103145	FERRITE CHOKE, TEM2011AA
LZ320 #2	23103906	FILTER, CHIP BEAD INDUCTOR, TEM2118AS
LZ330 #2	23103906	FILTER, CHIP BEAD INDUCTOR, TEM2118AS
LZ350 #2	23103906	FILTER, CHIP BEAD INDUCTOR, TEM2118AS
LZ360 #2	23103906	FILTER, CHIP BEAD INDUCTOR, TEM2118AS
LZ370 #2	23103906	FILTER, CHIP BEAD INDUCTOR, TEM2118AS
LZ380 #2	23103906	FILTER, CHIP BEAD INDUCTOR, TEM2118AS
LZ390 #2	23103906	FILTER, CHIP BEAD INDUCTOR, TEM2118AS
LZ810 #2	23103906	FILTER, CHIP BEAD INDUCTOR, TEM2118AS
T401	23224367	TRANSFORMER, HORIZ DRIVER, TLN1098AH
△T801	23211781	COIL, LINE FILTER 26X31H TRF3229AR
△T840	23217572	TRANSFORMER, POWER EI28 11.5V TPW1571AT
△T862	23217617	TRANSFORMER, CONV TRS ER4220 TPW3525AB
SEMICONDUCTORS		
Q201	23314163	TRANSISTOR, 2SA1162-Y
Q203	23205006	TRANSISTOR, KTC4075Y
Q204	23114460	TRANSISTOR, RN1204
Q205	23114460	TRANSISTOR, RN1204
Q206	23114499	TRANSISTOR, RN1404
Q220	23114460	TRANSISTOR, RN1204
Q301	23319787	IC, LA7833S
Q370	23314962	TRANSISTOR, KTA1266 Y
Q402	23114755	TRANSISTOR, 2SC2482FA-1
Q403	23314444	TRANSISTOR, 2SC4721, P
Q404	23314955	TRANSISTOR, 2SD2553(FA)
Q460	23314141	TRANSISTOR, 2SC3852
Q461	23314163	TRANSISTOR, 2SA1162-Y
Q470	23114433	TRANSISTOR, 2SC1815-Y
Q471	23114426	TRANSISTOR, 2SA1015-O(TEM
Q472	23205006	TRANSISTOR, KTC4075Y
Q480	23114759	TRANSISTOR, 2SA949-Y
Q481	23205006	TRANSISTOR, KTC4075Y
Q482	23205006	TRANSISTOR, KTC4075Y
Q483	23114469	TRANSISTOR, RN2201
Q501	23906843	IC, TA1310N
Q610	23906582	IC, AN5277
Q611	70114261	TRANSISTOR, 2SC3326-A
Q613	23314163	TRANSISTOR, 2SA1162-Y @U902
	70114261	TRANSISTOR, 2SC3326-A @UA01B
Q706	23314965	TRANSISTOR, KTC3198 Y
Q707	23314965	TRANSISTOR, KTC3198 Y
Q709	23314965	TRANSISTOR, KTC3198 Y
Q710	23314962	TRANSISTOR, KTA1266 Y
Q711	23314909	TRANSISTOR, 2SA1837
Q712	23314912	TRANSISTOR, 2SC4793
Q719	23314965	TRANSISTOR, KTC3198 Y
Q720	23314965	TRANSISTOR, KTC3198 Y
Q801	23135039	IC, HYBRID VDSS=450V STR-G9628
Q805	23114459	TRANSISTOR, RN1205
Q830	23009188	IC, KIA7805API
Q835	23009187	IC, REGULATOR +9V 4% KIA7809API

Location No.	Parts No.	Description
Q840	23009440	IC, REGULATOR +5V 4% DIP8 NJM78LR05BD
Q843	23114459	TRANSISTOR, RN1205
△ Q862	23009270	IC, PHOTO COUPLER, PS2581L1(D)
Q883	23319692	IC, SE130N, LF4
Q901	23314780	TRANSISTOR, 2SC4544
Q902	23314965	TRANSISTOR, KTC3198 Y
Q903	23314780	TRANSISTOR, 2SC4544
Q904	23314965	TRANSISTOR, KTC3198 Y
Q905	23314780	TRANSISTOR, 2SC4544
Q906	23314965	TRANSISTOR, KTC3198 Y
Q907	23314962	TRANSISTOR, KTA1266 Y
Q908	23114429	TRANSISTOR, 2SC2120-Y(TE)
Q910	23314965	TRANSISTOR, KTC3198 Y
Q911	23314965	TRANSISTOR, KTC3198 Y
Q912	23314962	TRANSISTOR, KTA1266 Y
Q913	23314962	TRANSISTOR, KTA1266 Y
Q914	23314965	TRANSISTOR, KTC3198 Y
Q920	23314965	TRANSISTOR, KTC3198 Y
Q921	23314965	TRANSISTOR, KTC3198 Y
Q922	23314965	TRANSISTOR, KTC3198 Y
Q923	23314965	TRANSISTOR, KTC3198 Y
Q924	23314965	TRANSISTOR, KTC3198 Y
Q925	23314965	TRANSISTOR, KTC3198 Y
Q2701	23906946	IC, CM0016AD
Q4460	23314475	TRANSISTOR, 2SC2712-Y
Q4461	23314475	TRANSISTOR, 2SC2712-Y
Q4462	23314475	TRANSISTOR, 2SC2712-Y
QA01	23085016	IC, MCU 1CHIP 8BIT 8M 42P TMP88CS38BN-5K03
QA02	23009647	IC, AT24C16A-10PI
QB03	23114459	TRANSISTOR, RN1205
QB11	23114528	TRANSISTOR, 2SC1740S
QB23	23205006	TRANSISTOR, KTC4075Y
QB30	23205006	TRANSISTOR, KTC4075Y
QB40	23314292	TRANSISTOR, 2SC4116-Y
QB41	23314292	TRANSISTOR, 2SC4116-Y
QB60	23314962	TRANSISTOR, KTA1266 Y
QB61	23314965	TRANSISTOR, KTC3198 Y
QB62	23314965	TRANSISTOR, KTC3198 Y
QD41	23009377	IC, A-PRO BBE AGC SDMP30 NJW1137M(TE1)
QD81	23114493	TRANSISTOR, RN2404
QD82	70114261	TRANSISTOR, 2SC3326-A
QD83	70114261	TRANSISTOR, 2SC3326-A
QG01	23009321	IC, US MTS DECODER QFP 48P T6 CXA2134Q-T6
QI01	23114611	TRANSISTOR, 2SC3357
QI02	23205005	TRANSISTOR, KTA2014Y
QI03	23205006	TRANSISTOR, KTC4075Y
QI05	23009240	IC, VIF/SIF SSOP24PIN TA1274F(FA03A5,EL)
QS60	23314475	TRANSISTOR, 2SC2712-Y
QS61	23314475	TRANSISTOR, 2SC2712-Y
QS62	23114493	TRANSISTOR, RN2404
QS63	70114261	TRANSISTOR, 2SC3326-A
QS64	70114261	TRANSISTOR, 2SC3326-A
QS101	23906597	IC, BA4558F
QV01	23000368	IC, MM1495XF
QV02	23205006	TRANSISTOR, KTC4075Y
QV05	23114500	TRANSISTOR, RN1403
QV10	23114500	TRANSISTOR, RN1403
QV60	23314965	TRANSISTOR, KTC3198 Y
QZ01 #1	23000559	IC, TC90A49F(ELP)
QZ04	23314965	TRANSISTOR, KTC3198 Y
QZ05	23314962	TRANSISTOR, KTA1266 Y
QZ06	23314965	TRANSISTOR, KTC3198 Y
QZ08	23314962	TRANSISTOR, KTA1266 Y
QZ14	23314962	TRANSISTOR, KTA1266 Y
QZ20	23314965	TRANSISTOR, KTC3198 Y
QZ23	23314962	TRANSISTOR, KTA1266 Y

Location No.	Parts No.	Description
QZ030 #2	23000282	IC, R1121N*, 23000282L NI TOUITSU
QZ210	23314475	TRANSISTOR, 2SC2712-Y
QZ220	23314475	TRANSISTOR, 2SC2712-Y
QZ250 #2	23314163	TRANSISTOR, 2SA1162-Y
QZ260 #2	23906770	IC, BA033FP
D101	23316755	DIODE, ZENER, MTZJ33C
D201	23118859	DIODE, 1SS133
D221	23118859	DIODE, 1SS133
D222	23118859	DIODE, 1SS133
D225	23357281	DIODE, DZ9.1 BS A
D226	23357281	DIODE, DZ9.1 BS A
D301	23118094	DIODE, EU2A
D302	23357372	DIODE, AXIAL EU2JGF-41U2
D310	23118859	DIODE, 1SS133
D311	23316666	DIODE, ZENER, MTZJ4.7B
D313	23118859	DIODE, 1SS133
D319	23316719	DIODE, ZENER, MTZJ12B
D320	23316719	DIODE, ZENER, MTZJ12B
D370	23357267	DIODE, DZ5.6 BS B
D371	23118859	DIODE, 1SS133
D406	23357372	DIODE, AXIAL EU2JGF-41U2
D409	23316690	DIODE, ZENER, MTZJ10B
D411	23357279	DIODE, ZENER, DZ8.2 BS B
D430	23118510	DIODE, ZENER, RD12ES
D441	23357282	DIODE, DZ9.1 BS B
D442	23118094	DIODE, EU2A
D444	23316254	DIODE, ERC06-15
D461	23118338	DIODE, RU4AM LF-K2
D462	23118859	DIODE, 1SS133
D463	23118859	DIODE, 1SS133
D466	23357248	DIODE, DZ2.7 BS B
D467	23357372	DIODE, AXIAL EU2JGF-41U2
D471	23118094	DIODE, EU2A
△ D472	23115774	DIODE, ZENER, RD6.2E(FA-1)
D473	23118859	DIODE, 1SS133
D480	23357299	DIODE, DZ16 BS A
D610	23118041	DIODE, MA111
D611	23118041	DIODE, MA111
D613	23118041	DIODE, MA111
D614	23118041	DIODE, MA111
D615	23118041	DIODE, MA111
D704	23118859	DIODE, 1SS133
D705	23118859	DIODE, 1SS133
D715	23118859	DIODE, 1SS133
D720	23118859	DIODE, 1SS133
D721	23118859	DIODE, 1SS133
△ D801	23357041	DIODE, LN6SB60-F05
D805	23118859	DIODE, 1SS133
D806	23118094	DIODE, EU2A
D807	23118859	DIODE, 1SS133
D810	23316269	DIODE, AK04
D811	23118859	DIODE, 1SS133
D840	23357365	DIODE, 1N4004A-B5
D841	23357365	DIODE, 1N4004A-B5
D842	23357365	DIODE, 1N4004A-B5
D843	23357365	DIODE, 1N4004A-B5
D845	23118859	DIODE, 1SS133
D855	23118859	DIODE, 1SS133
D882	23118635	DIODE, ZENER, RD2.7ESA B2
D883	23118338	DIODE, RU4AM LF-K2
D885	23118052	DIODE, RU4Z LF-L1
D890	23118052	DIODE, RU4Z LF-L1
△ D899	24019485	VARISTOR, TNR10V431K
D901	23118859	DIODE, 1SS133
D903	23118859	DIODE, 1SS133
D904	23118859	DIODE, 1SS133

Location No.	Parts No.	Description
D905	23118859	DIODE, 1SS133
D906	23118859	DIODE, 1SS133
D907	23118859	DIODE, 1SS133
D908	23118859	DIODE, 1SS133
D909	23118859	DIODE, 1SS133
D910	23118859	DIODE, 1SS133
D911	23115337	DIODE, 1S1834
D2701	23118859	DIODE, 1SS133
D2702	23118859	DIODE, 1SS133
DA02	23118041	DIODE, MA111
DA03	23118041	DIODE, MA111
DA04	23118041	DIODE, MA111
DA05	23118041	DIODE, MA111
DA42	23357037	DIODE, ZENER, UDZS5.6B
DB01	23358571	DIODE, LED, BT-H254N-31-SH
DB03	23358522	DIODE, LED, SIR-56SB3F
DB05	23316675	DIODE, ZENER, MTZJ6.2B
DB30	23118859	DIODE, 1SS133
DB45	23118041	DIODE, MA111
DD82	23118859	DIODE, 1SS133
DS106	23316669	DIODE, ZENER, MTZJ5.1B
DV46	23316716	DIODE, ZENER, MTZJ11B
DV47	23316686	DIODE, ZENER, MTZJ9.1A
KB01	23906805	IC, REMOTE PHOTO RECIEVER, PIC-TB17
MISCELLANEOUS		
B205	23974994	BAND, KESSOKU
BB01A	23713014	CONNECTOR, BRIDGE PLUG 16P 1.5
BB01B	23713013	CONNECTOR, SOCKET, B-B 16P 1.5
BB02A	23713014	CONNECTOR, BRIDGE PLUG 16P 1.5
BB02B	23713013	CONNECTOR, SOCKET, B-B 16P 1.5
BB03A	23713014	CONNECTOR, BRIDGE PLUG 16P 1.5
BB03B	23713013	CONNECTOR, SOCKET, B-B 16P 1.5
BB04A	23902749	CONNECTOR, SOCKET, B-B 6P
BB04B	23368517	CONNECTOR, PLUG, B-B 6P
BB05A	23713014	CONNECTOR, BRIDGE PLUG 16P 1.5
BB05B	23713013	CONNECTOR, SOCKET, B-B 16P 1.5
BB06A	23713014	CONNECTOR, BRIDGE PLUG 16P 1.5
BB06B	23713013	CONNECTOR, SOCKET, B-B 16P 1.5
BB160	23368627	CONNECTOR, BRIDGE B-B 8P 2.5JST 08TM-2.5FJ-E
BB16A	23903022	CONNECTOR, BASE B-B 8P 2.5 JST
BB16B	23903022	CONNECTOR, BASE B-B 8P 2.5 JST
△ F470	23144854	FUSE
F470A	23165102	FUSE HOLDER, CLIP, PC-BOARD D=5.2
F470B	23165102	FUSE HOLDER, CLIP, PC-BOARD D=5.2
△ F801	23144518	FUSE, CARTRIDGE, 125V 10A
F801A	23165102	FUSE HOLDER, CLIP, PC-BOARD D=5.2
F801B	23165102	FUSE HOLDER, CLIP, PC-BOARD D=5.2
△ F802	23144681	FUSE, CARTRIDGE 5X20 125V 4.0A
F802A	23165102	FUSE HOLDER, CLIP, PC-BOARD D=5.2
F802B	23165102	FUSE HOLDER, CLIP, PC-BOARD D=5.2
△ F804	23144681	FUSE, CARTRIDGE 5X20 125V 4.0A
F804A	23165102	FUSE HOLDER, CLIP, PC-BOARD D=5.2
F804B	23165102	FUSE HOLDER, CLIP, PC-BOARD D=5.2
G040	23103145	FERRITE CHOKE, TEM2011AA
G101	24366151	CARBON FILM, 1/6W 150 OHM J
G102	24366151	CARBON FILM, 1/6W 150 OHM J
G114	23103145	FERRITE CHOKE, TEM2011AA
G217	24366273	CARBON FILM, 1/6W 27K OHM J
G402	23103145	FERRITE CHOKE, TEM2011AA
G404	23238714	COIL, PEAKING, TRF4100AJ
G405	23103145	FERRITE CHOKE, TEM2011AA
G465	24366332	CARBON FILM, 1/6W 3.3K OHM J
G845	23103145	FERRITE CHOKE, TEM2011AA
GJ02	24000445	CHIP JUMPER, 1608TYPE
GJ85	24503053	PLASTIC FILM, 63V 1UF J

Location No.	Parts No.	Description
GR01	24011470	CHIP, METAL FILM, 1/20W 47 OHM J
GR02	24011101	CHIP, METAL FILM, 1/20W 100 OHM J
GR03	24011101	CHIP, METAL FILM, 1/20W 100 OHM J
GRV60	24000445	CHIP JUMPER, 1608TYPE
J997A	23960136	ADHESIVE, SILICONE, TSE3843-W
J998A	23960136	ADHESIVE, SILICONE, TSE3843-W
J999A	23960136	ADHESIVE, SILICONE, TSE3843-W
JR001	24000445	CHIP JUMPER, 1608TYPE @U902
	24000576	JUMPER CHIP, 3216TYPE @U801
JR002	24000445	CHIP JUMPER, 1608TYPE @U902
	24000824	CHIP JUMPER, 2125TYPE @U801
JR003	24000445	CHIP JUMPER, 1608TYPE @U902
	24000445	CHIP JUMPER, 1608TYPE @U801
JR004	24000445	CHIP JUMPER, 1608TYPE @U902
	24000824	CHIP JUMPER, 2125TYPE @U801
JR005	24000445	CHIP JUMPER, 1608TYPE
JR006	24000445	CHIP JUMPER, 1608TYPE @U902
	24000576	JUMPER CHIP, 3216TYPE @U801
JR007	24000445	CHIP JUMPER, 1608TYPE @U902
	24000824	CHIP JUMPER, 2125TYPE @U801
JR008	24000445	CHIP JUMPER, 1608TYPE @U902
	24000576	JUMPER CHIP, 3216TYPE @U801
JR009	24000445	CHIP JUMPER, 1608TYPE
JR010	24000445	CHIP JUMPER, 1608TYPE @U902
	24000445	CHIP JUMPER, 1608TYPE @U801
JR011	24000445	CHIP JUMPER, 1608TYPE @U902
	24000576	JUMPER CHIP, 3216TYPE @U801
JR012	24000445	CHIP JUMPER, 1608TYPE @U902
	24000824	CHIP JUMPER, 2125TYPE @U801
JR013	24000445	CHIP JUMPER, 1608TYPE
JR014	24000824	CHIP JUMPER, 2125TYPE
JR015	24000445	CHIP JUMPER, 1608TYPE @U902
	24000576	JUMPER CHIP, 3216TYPE @U801
JR016	24000824	CHIP JUMPER, 2125TYPE
JR017	24000445	CHIP JUMPER, 1608TYPE @U902
	24000576	JUMPER CHIP, 3216TYPE @U801
JR018	24000445	CHIP JUMPER, 1608TYPE @U902
	24000576	JUMPER CHIP, 3216TYPE @U801
JR019	24000445	CHIP JUMPER, 1608TYPE @U902
	24000576	JUMPER CHIP, 3216TYPE @U801
JR020	24000445	CHIP JUMPER, 1608TYPE @U902
	24000824	CHIP JUMPER, 2125TYPE @U801
JR022	24000445	CHIP JUMPER, 1608TYPE
JR024	24000445	CHIP JUMPER, 1608TYPE
JR025	24000445	CHIP JUMPER, 1608TYPE
JR026	24000445	CHIP JUMPER, 1608TYPE
JR027	24000445	CHIP JUMPER, 1608TYPE
JR028	24000445	CHIP JUMPER, 1608TYPE
JR029	24000445	CHIP JUMPER, 1608TYPE
JR030	24000445	CHIP JUMPER, 1608TYPE
JR031	24000445	CHIP JUMPER, 1608TYPE
JR032	24000445	CHIP JUMPER, 1608TYPE
JR033	24000445	CHIP JUMPER, 1608TYPE
JR034	24000445	CHIP JUMPER, 1608TYPE
JR035	24000445	CHIP JUMPER, 1608TYPE
JR036	24000445	CHIP JUMPER, 1608TYPE
JR040	24000445	CHIP JUMPER, 1608TYPE
JR041	24000445	CHIP JUMPER, 1608TYPE
M461A	23192957	ANODE CAP ASSY, TCC5602AT
M461B	23505090	CABLE, CABLE FOCUS
M461D	23504719	CABLE, SCREEN
N726	23969041	TAPE WHITE 3M #1, W=1 INCH TNP COMMON
P405	23368579	CONNECTOR, PLUG 5P, 2.5MM G JST-EH, B5B-EH-F1-TV4
P501	23368581	CONNECTOR, PLUG 7P, 2.5MM G JST-EH B7B-EH-F1-TV4
P701	23368578	CONNECTOR, PLUG 4P, 2.5MM G JST-EH, B4B-EH-F1-TV4
P702	23368578	CONNECTOR, PLUG 4P, 2.5MM G JST-EH, B4B-EH-F1-TV4

Location No.	Parts No.	Description
△ P801	23372113	POWER CORD, U/C 125V10A HSV 2 CMC-02P 1
P903	23368579	CONNECTOR, PLUG 5P, 2.5MM G JST-EH, B5B-EH-F1-TV4
P910	23164725	CONNECTOR, PLUG 2P
PV01	23023239	JACK, 1S+14P JACK (10SW) MSP-834V1-01 NILF
PV05	23023214	JACK, 1S+PIN 416V-BAA-432 NI LF
Q301B	72471082	SCREW, 3X10MM
Q404B	72471082	SCREW, 3X10MM
Q460B	72471082	SCREW, 3X10MM
Q801B	72471082	SCREW, 3X10MM
Q830B	70391355	SCREW, BIND HEAD TAP-TITE B, BITTB 3X8 SZN
Q835B	70391355	SCREW, BIND HEAD TAP-TITE B, BITTB 3X8 SZN
SA01	23145227	SWITCH, PUSH, 1C1P
SA02	23145227	SWITCH, PUSH, 1C1P
SA03	23145227	SWITCH, PUSH, 1C1P
SA04	23145227	SWITCH, PUSH, 1C1P
SA05	23145227	SWITCH, PUSH, 1C1P
SA06	23145227	SWITCH, PUSH, 1C1P
SA07	23145227	SWITCH, PUSH, 1C1P
SA08	23145227	SWITCH, PUSH, 1C1P
△ SR81	23146564	RELAY, DC12V, TV5, DG-3
SR83	23146564	RELAY, DC12V, TV5, DG-3
V901A	23903174	SOCKET, ISH46S-EN ING ISH46S-EN
W661	23351128	SPEAKER, SPK1389, 60X120 16-OHM 6W
W662	23351128	SPEAKER, SPK1389, 60X120 16-OHM 6W
X401	23153721	CERAMIC RESONATOR, 503KHZ
X501	23153961	CRYSTAL, 3.58MHZ
XA01	23153504	CERAMIC RESONATOR, 8.00MHZ 25OHM
ZI51	23303197	PIF SAW FILTER, TSF1248P TSF1248P
ZI52	23303271	FILTER, TRAP 4.5MHZ, TCF1138AM
ZI53	23303289	FILTER, TCF1141AM
ZI55	23303244	FILTER, CERAMIC TRAP TCF1121AM
PC BOARD ASSEMBLIES		
* U001	23762128	PC BOARD ASSY, IF 32AFX54 PD1022A IF
* U801 #1	23762142	PC BOARD ASSY, MAIN 32AF44 PD1765A MAIN
* #2	23762051	PC BOARD ASSY, MAIN 32AFX54 PD1765 MAIN
* U901 #1	23762145	PC BOARD ASSY, CRT/D 32AF44 PD1764A CRT/D
* #2	23762050	PC BOARD ASSY, CRT/D 32AFX54 PD1764 CRT/D
* U902 #1	23762143	PC BOARD ASSY, SUB 32AF44 PD1766A SUB
* #2	23762052	PC BOARD ASSY, SUB 32AFX54 PD1766 SUB
* UA01A#1	23762162	PC BOARD ASSY, FRONT1 32AF44 PD1787A-1 FNT1
* #2	23762129	PC BOARD ASSY, FRONT1 32AFX54 PD1787-1 FNT1
* UA01B#1	23762144	PC BOARD ASSY, FRONT2 32AF44 PD1787A-2 FNT2
* #2	23762130	PC BOARD ASSY, FRONT2 32AFX54 PD1787-2 FNT2
PICTURE TUBE		
△ V901	23324103	PICTURE TUBE, 32VPF MTPD ITC A80AKS90X07
TUNER		
△ H001	23321456	TUNER, US181CH IIC F 5V ELA51LX7
ACCESSORIES		
A701 #1	23064255	CARTON, CARTON
#2	23067435	CARTON, CARTON
A703	23946056	PACKING, TOP PACKING
A708	23946057	PACKING, BOTTOM PACKING
△ K912 #1	23306517	REMOCON HAND UNIT IR, CTVUSA CT-90157
#2	23306496	REMOCON HAND UNIT IR, CTVUSA CT-90158
△ Y101 #1	23566350	OWNERS MANUAL, ENGLISH/FRENCH 32AF44
#2	23566341	OWNERS MANUAL, ENGLISH/FRENCH 32AFX54
CABINET PARTS		
A201 #1	23532714	COVER, FRONT COVER ASSY 32AF44
#2	23532716	COVER, FRONT COVER ASY 32AFX54
A213 #1	23428282	DOOR, DOOR
#2	23428284	DOOR, DOOR

Location No.	Parts No.	Description
A214	23451976	PUSH CATCH, CLICK
A223 #1	23445816	BUTTON, POWER BUTTON
A224	23445815	BUTTON, CONTROL BUTTON
A225 #2	23445819	BUTTON, POWER BUTTON
A411	23540031	COVER, BACK COVER PROPER
#2	23540031	COVER, BACK COVER PROPER

MAIN BOARD (32AF44:PD1765A 32AFX54:PD1765) (U801)

BOTTOM (FOIL) SIDE

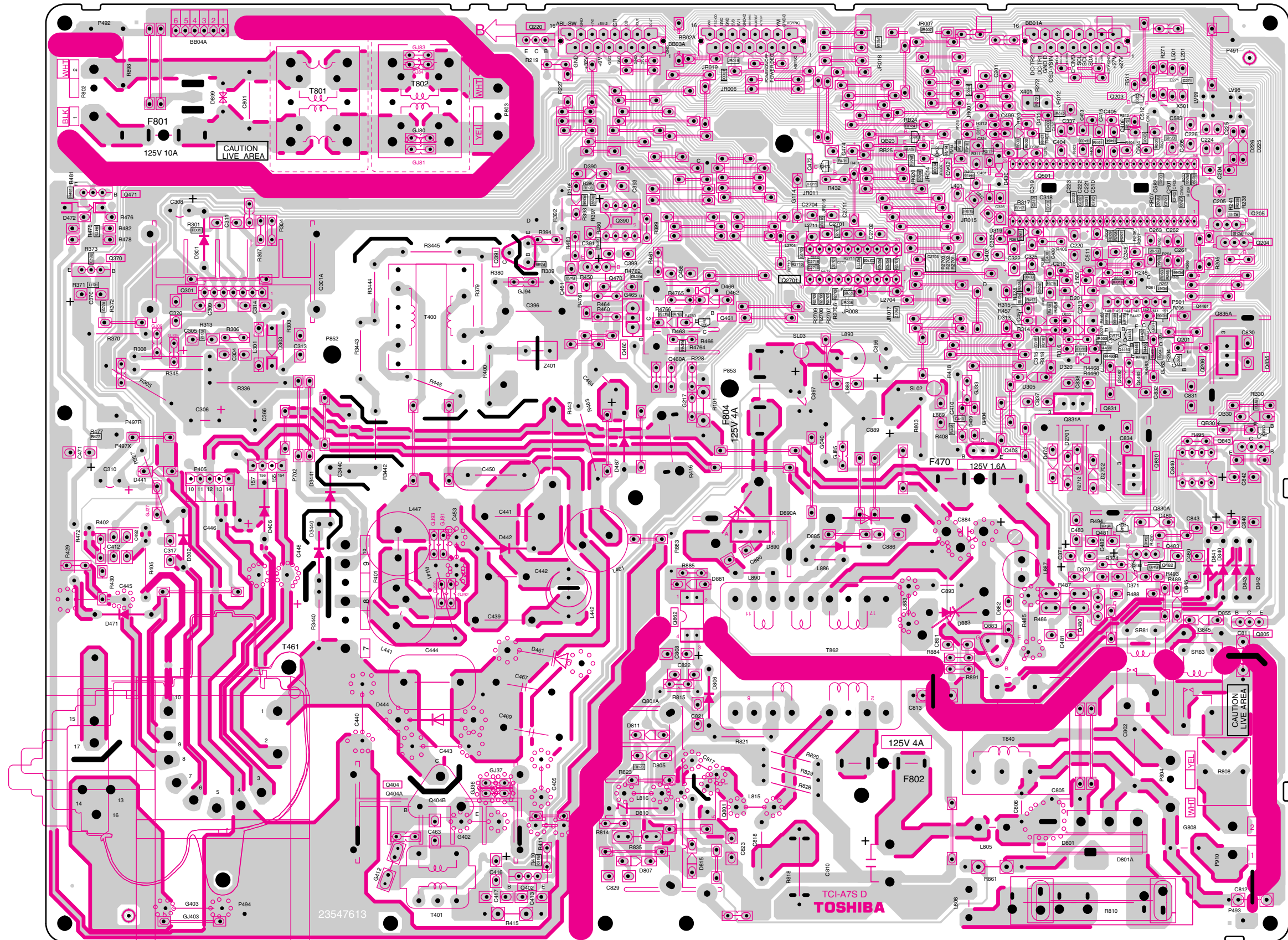

FRONT1 BOARD (32AF44:PD1787A-1 32AFX54:PD1787-1) (UA01A)
BOTTOM (FOIL) SIDE

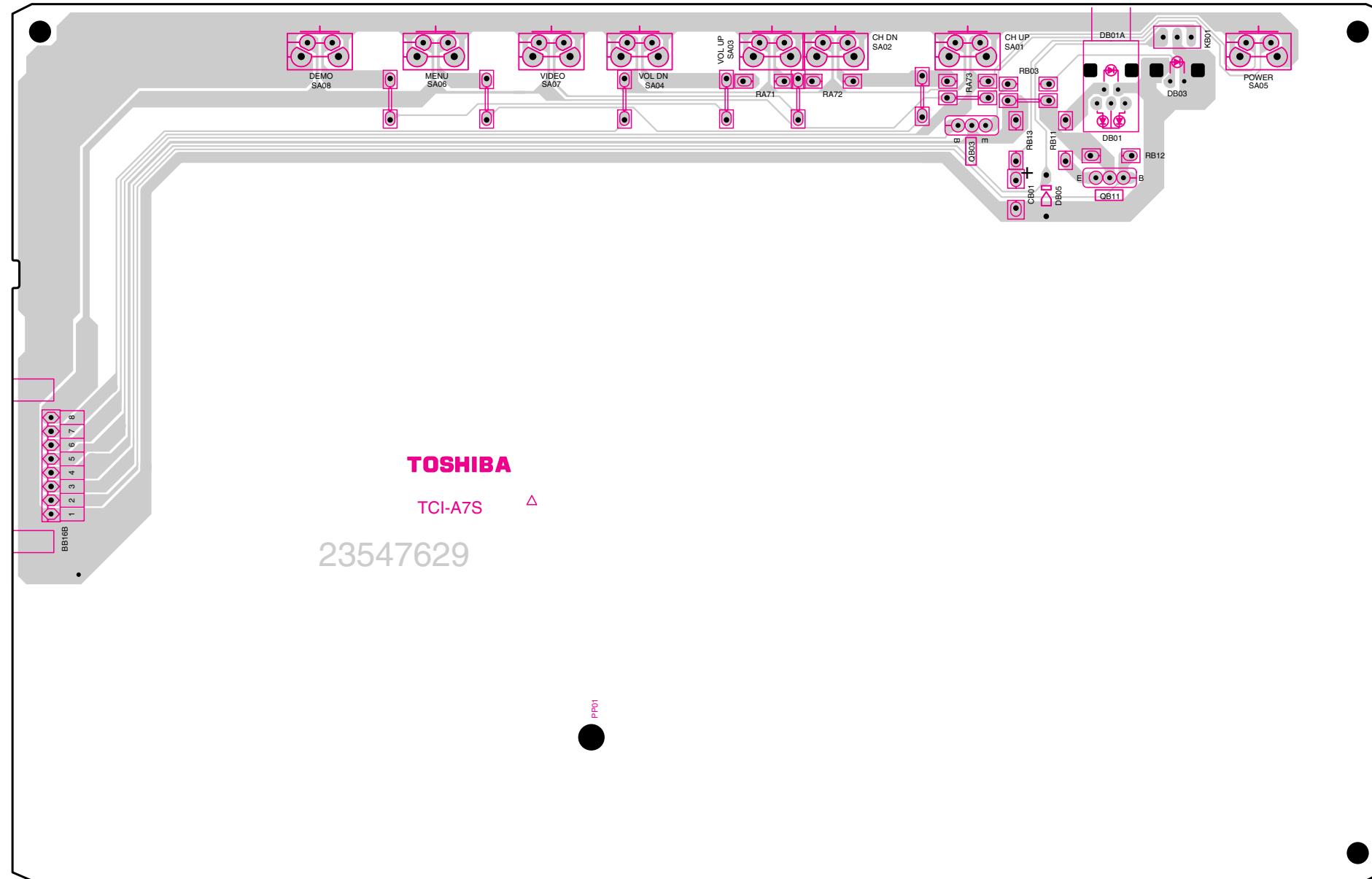

TERMINAL VIEW OF TRANSISTORS

- ① 2SD2253
(old)
2SC5243

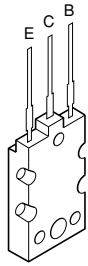

- ② 2SC3852
2SD1763A
2SC1569
2SC4544
2SA1788
2SA1306
2SA1186A

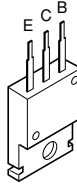

- ③ 2SC752GTM
2SC2482
2SC2655
2SC4721P

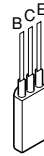

- ④ 2SC752
2SA562TM
2SA1015
2SC1815
2SC2878
2SC1740S
2SC2120
2SA9335

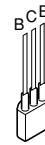

- ⑤ 2SA1788

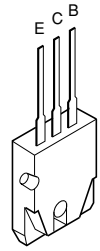

- ⑥ RN2203
RN2201
RN2004
RN1203
RN1204
RN2204
RN1205
RN1202
RN1201

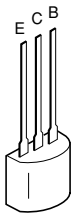

- ⑦ 2SD1554
2SD2253
2SD1556
2SD2553
2SC5143

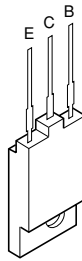

- ⑧ ON4409

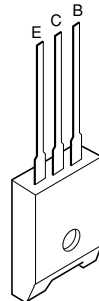

CIRCUIT BLOCK DIAGRAM

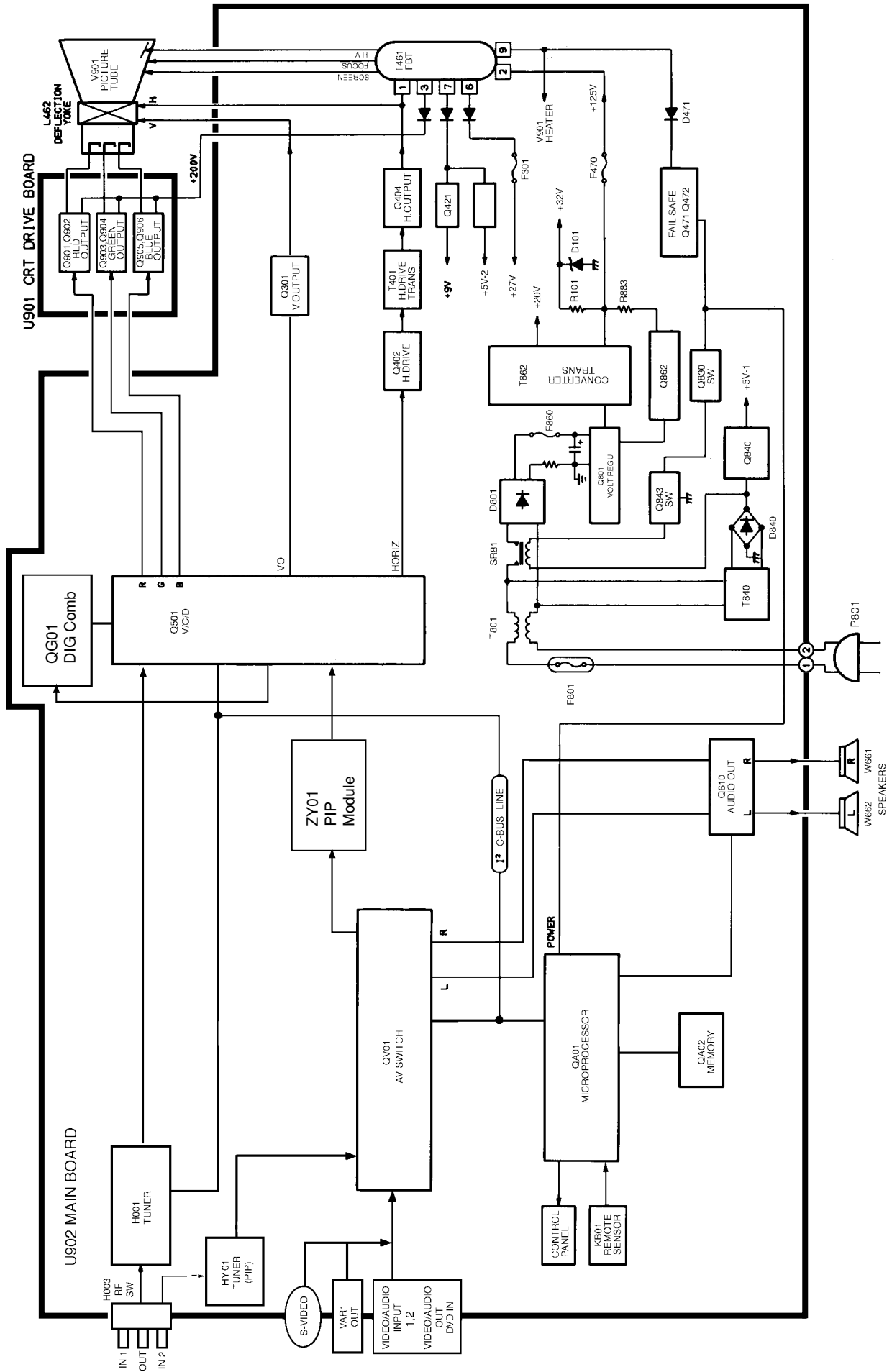

Specifications

Television System	NTSC standard
Channel Coverage	VHF: 2 through 13 UHF: 14 through 69 Cable TV: Mid band (A-8 through A-1, A through I) Super band (J through W) Hyper band (AA through ZZ, AAA, BBB) Ultra band (65 through 94, 100 through 125)
Power Source	120 V AC, 60 Hz
Power Consumption	32AF44: 106 W (average) 32AFX54: 107 W (average)
Audio Power	5 W + 5 W
Speaker Type	Two 2-3/8 x 4-3/4 inches (60 x 120 mm)
Video/Audio Terminals	S-VIDEO INPUT Y: 1 V(p-p), 75 ohm, negative sync. C: 0.286 V(p-p) (burst signal), 75 ohm VIDEO/AUDIO INPUT VIDEO: 1 V(p-p), 75 ohm, negative sync. AUDIO: 150 mV(rms) (30% modulation equivalent, 47 kohm) ColorStream™ (component video) INPUT Y: 1V(p-p), 75 ohm PB: 0.7 V(p-p), 75 ohm PR: 0.7 V(p-p), 75 ohm AUDIO: 150 mV(rms), 47 kohm VIDEO/AUDIO OUTPUT VIDEO: 1 V(p-p), 75 ohm, negative sync. AUDIO: 150mV(rms) (30% modulation equivalent, 4.7 kohm)
Dimensions	Width: 34-1/2 inches (876.3 mm) Height: 26-1/2 inches (673.1 mm) Depth: 22-5/8 inches (574.7 mm)
Weight	144 lbs. (65.3 kg)
Supplied Accessories	Remote control with 2 size “AA” alkaline batteries
Optional TV stand	ST3264

Design and specifications are subject to change without notice.

TOSHIBA CORPORATION

1-1, SHIBAURA 1-CHOME, MINATO-KU, TOKYO 105-8001, JAPAN