

USER INTERFACE

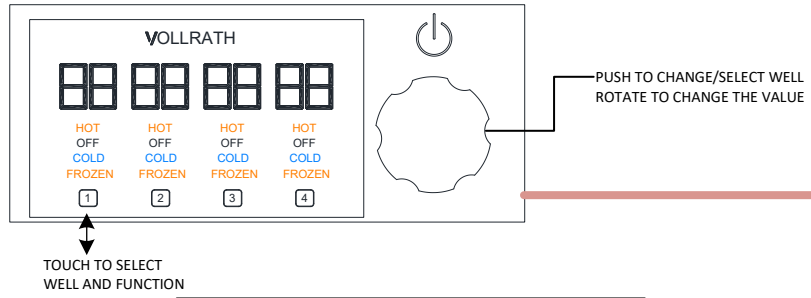

356263-1
1-4 WELL HOT, COLD & FROZEN WIRING DIAGRAM

TO 2ND CONDENSING UNIT-- 4 WELL ONLY
TO CONDENSING UNIT-- SEE OTHER SHEET

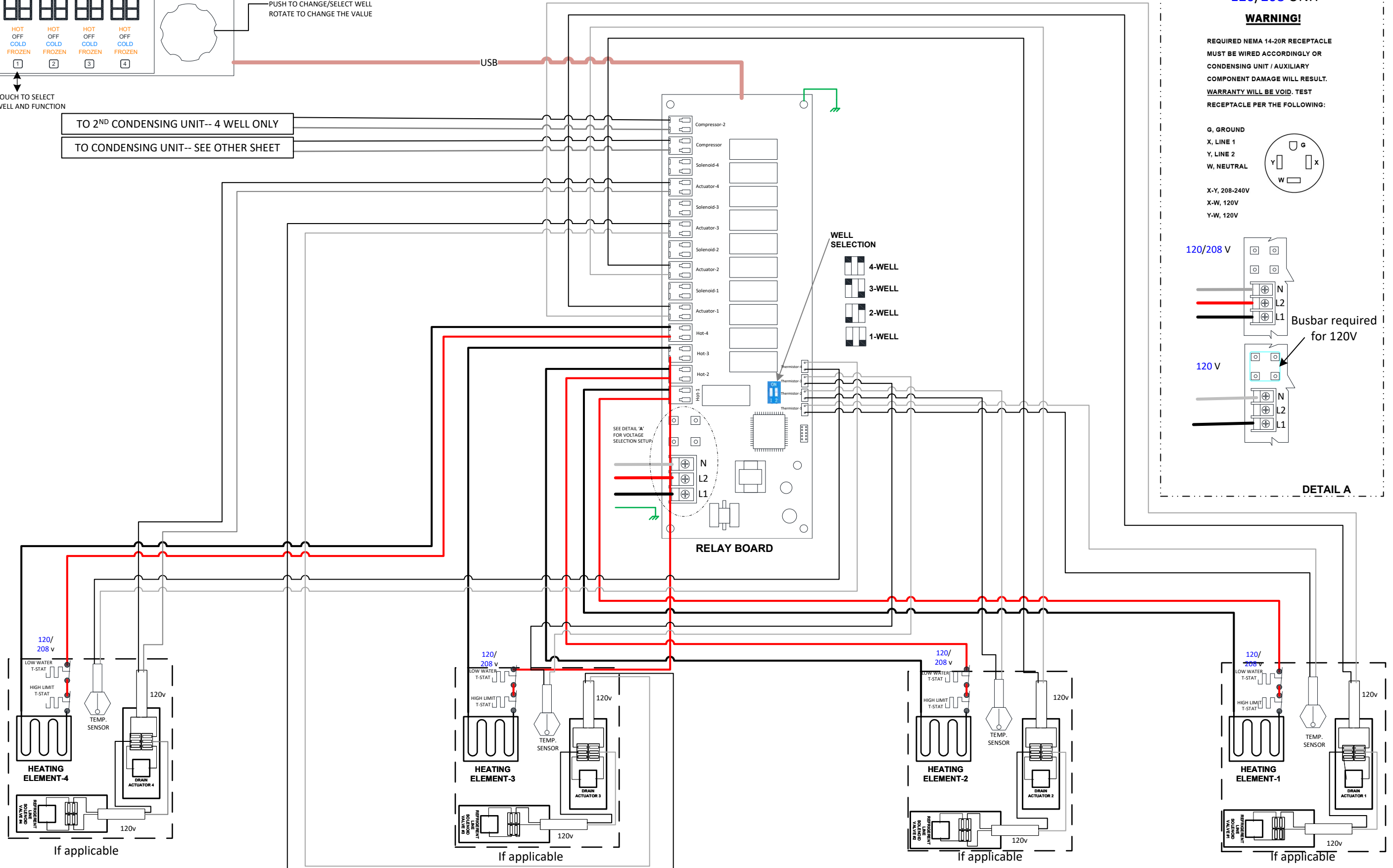

120/208 UNIT

WARNING!

REQUIRED NEMA 14-20R RECEPTACLE
MUST BE WIRED ACCORDINGLY OR
CONDENSING UNIT / AUXILIARY
COMPONENT DAMAGE WILL RESULT.
WARRANTY WILL BE VOID. TEST
RECEPTACLE PER THE FOLLOWING:

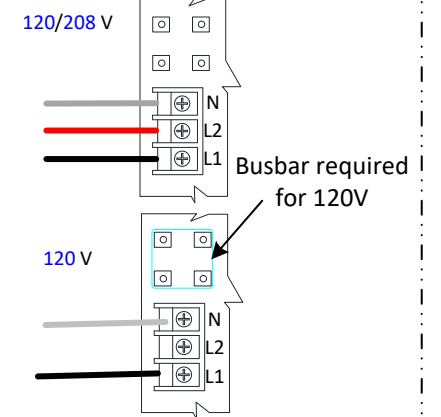
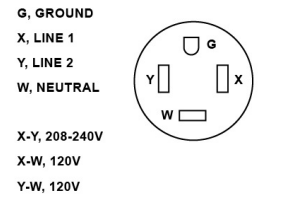

DETAIL A

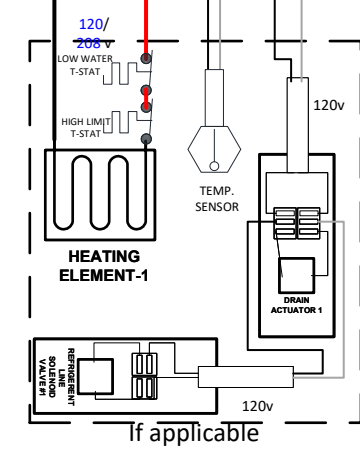
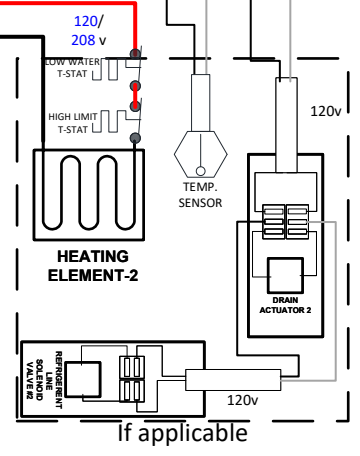
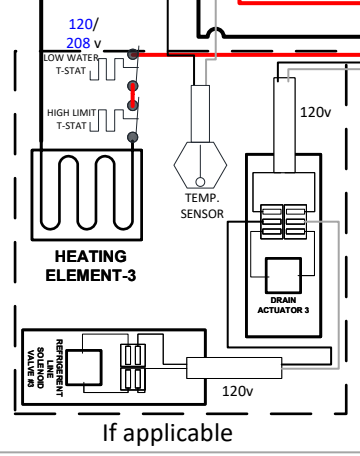
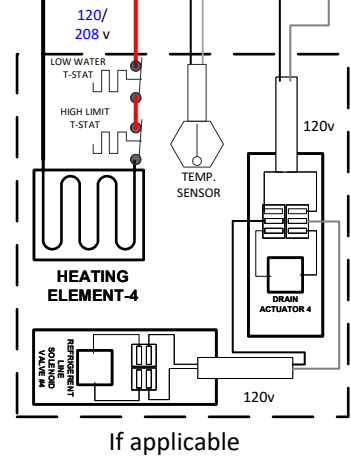

356263-1
1-4 WELL HOT, COLD & FROZEN WIRING DIAGRAM

**CONDENSING UNIT CONTROL BOARD
 FUNCTION FLOW CHART**

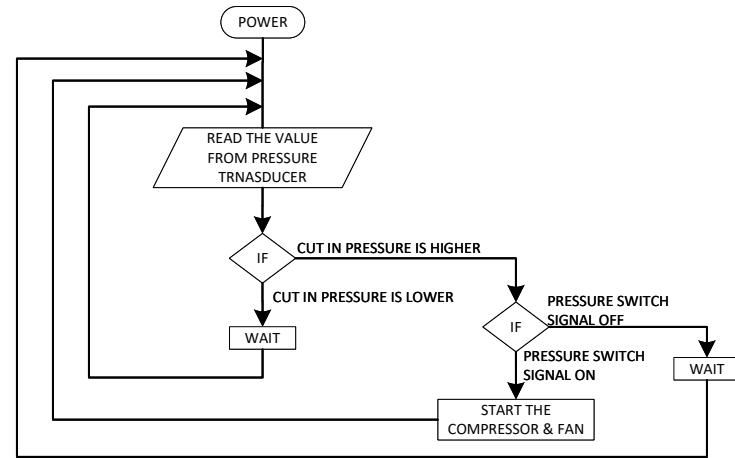

**RELAY CONTROL BOARD
 FUNCTION FLOW CHART**

Initial condition

- Drain valve -Closed
- Refrigerent line valve -Closed

